



2024 DODGE HORNET PLUG-IN HYBRID

EMERGENCY RESPONSE GUIDE



Gasoline-Electric Hybrid Vehicle

Revision 2023-06-20-02

This brochure is a publication of FCA US LLC. All product illustrations and specifications are based upon current information at the time of publication approval. FCA US LLC reserves the right to make changes from time to time, without notice or obligation, in prices, specifications, colors and materials, and to change or discontinue models, which are considered necessary to the purpose of product improvement or for reason of design and/or marketing.

CONTENTS

1. Identification / recognition	Page 3
2. Immobilization / stabilization / lifting	Page 4
3. Disable direct hazards / safety regulations	Page 6
4. Access to the occupants	Page 11
5. Stored energy / liquids / gases / solids	Page 15
6. In case of fire	Page 18
7. In case of submersion	Page 19
8. Towing / transportation / storage (2 nd Responder Guidance)	Page 20
9. Important additional information	Page 25
10. Explanation of pictograms used	Page 27

The Dodge Hornet Plug-In Hybrid can be identified by the following external indications:

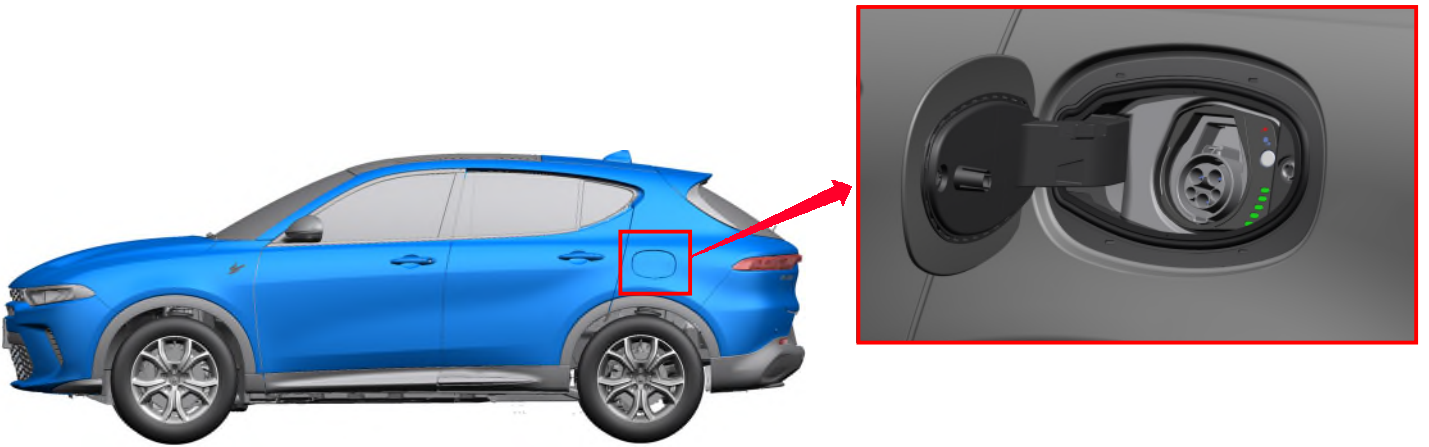

A charge port door, which is located at the Left-side quarter panel.

The Dodge Hornet Plug-In Hybrid can be identified by the following internal indications:



E-Save Drive Mode selector on the floor console by the gear selector lever.

Dodge Hornet Plug-In Hybrid vehicles equipped with these features are hybrid-electric vehicles and utilize a high voltage lithium-ion power source in addition to liquid fossil fuel for propulsion energy. All practices and precautions for working with hybrid-electric vehicles should be followed when responding to an incident involving one of these vehicles.

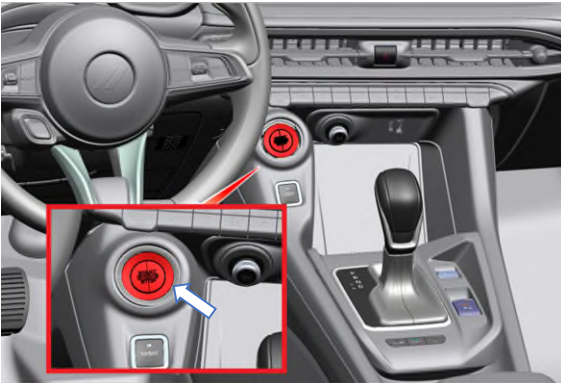

The Dodge Hornet Plug-In Hybrid employs lever electronic shift control. With 12-volt power active (ignition set to “RUN” or “ACC”), the transmission can be shifted between any mode including PARK and NEUTRAL, and the PARKING BRAKE can be engaged or disengaged.

For rescue and firefighting activities, if safe to do so, put the vehicle into PARK and engage the PARKING BRAKE.

Shifting in and out of PARK and actuating the PARKING BRAKE

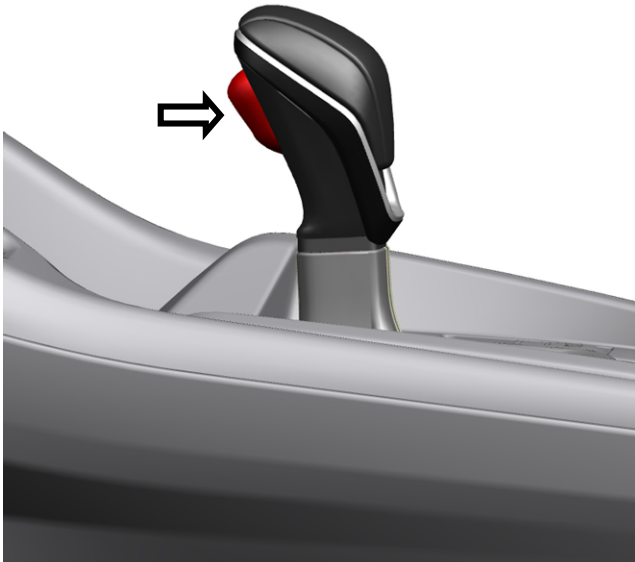

- This vehicle uses a lever selector for the automatic transmission, located on the center floor console. To shift the vehicle to PARK, press in on the brake pedal, squeeze the selector lever button and push forward on the selector lever to the “P” position.
- To place the vehicle in NEUTRAL, press on the brake pedal, then squeeze the selector lever button and pull the selector lever from park 2 clicks until the selector lever is in the “N” position.
- The electric parking brake switch is located on the center floor console near the base of the selector lever. To apply the PARKING BRAKE, pull the switch. The LED on the switch and the “BRAKE” warning on the instrument cluster will illuminate when the brake is set.



Note: 12V power must be activated to shift in and out of PARK with the electronic shift control or to change the PARKING BRAKE state.

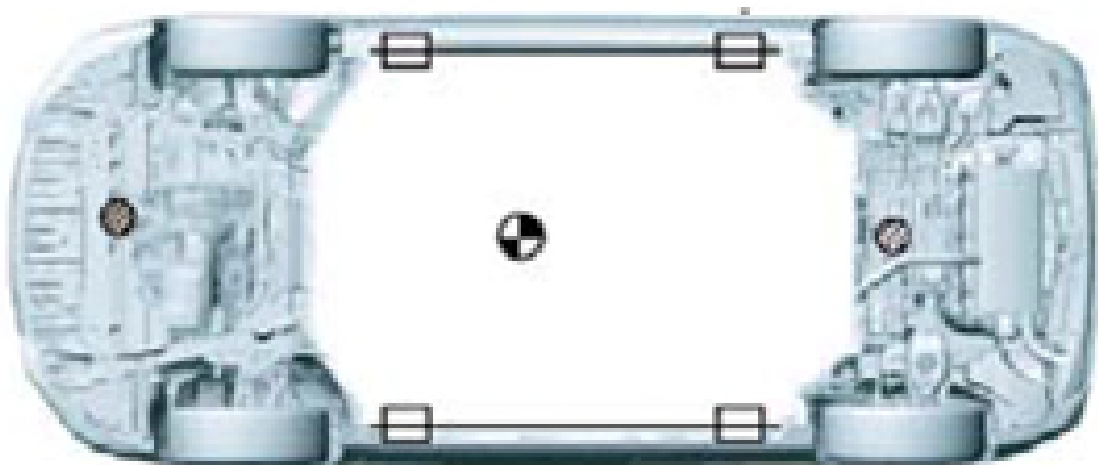
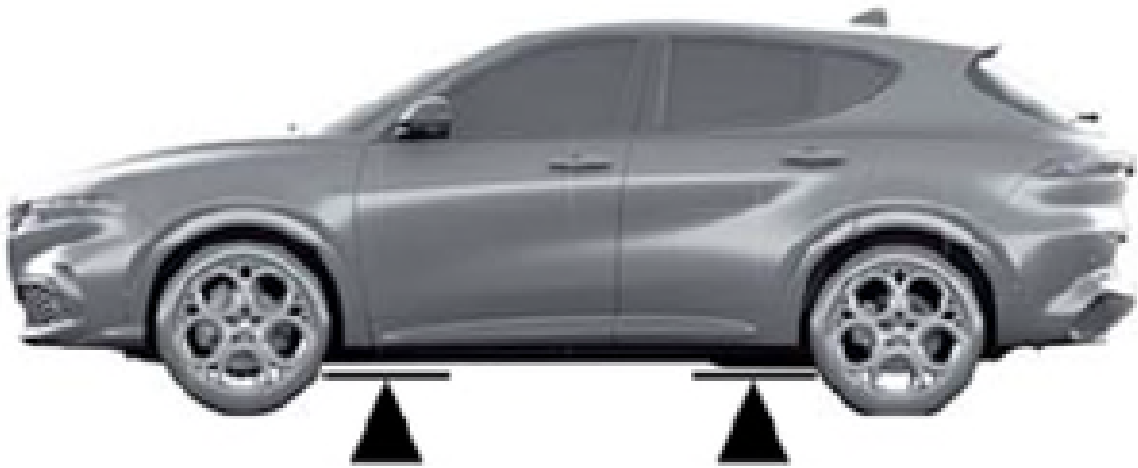

WARNING: In rare instances, rotation of the drive wheels may result in the generation of high voltage electrical energy external to the high voltage battery isolation device and may also trigger a propulsion system response. Place in PARK to prevent rotation if able. **DO NOT PUSH.**

In addition to the use of wheel chocks, if deemed appropriate by incident command, the Dodge Hornet Plug-In Hybrid may be lifted off its wheels to further stabilize or gain access. This lifting should be accomplished by supporting only at the lift points along the frame rail indicated by arrows shown below:



-  Jack Position
-  Support position
-  Vehicle Center of Gravity

Determination of actual lift points must be made by incident command based on the unique situational factors such as relocation of the hazards illustrated on the ensuing pages as a result of impact events. These are only recommendations.

Dodge Hornet Plug-In Hybrid – RESCUE SHEET

	<h1>Dodge Hornet</h1> <h2>5e Plug-In Hybrid</h2> <h3>2024</h3>	
--	--	--

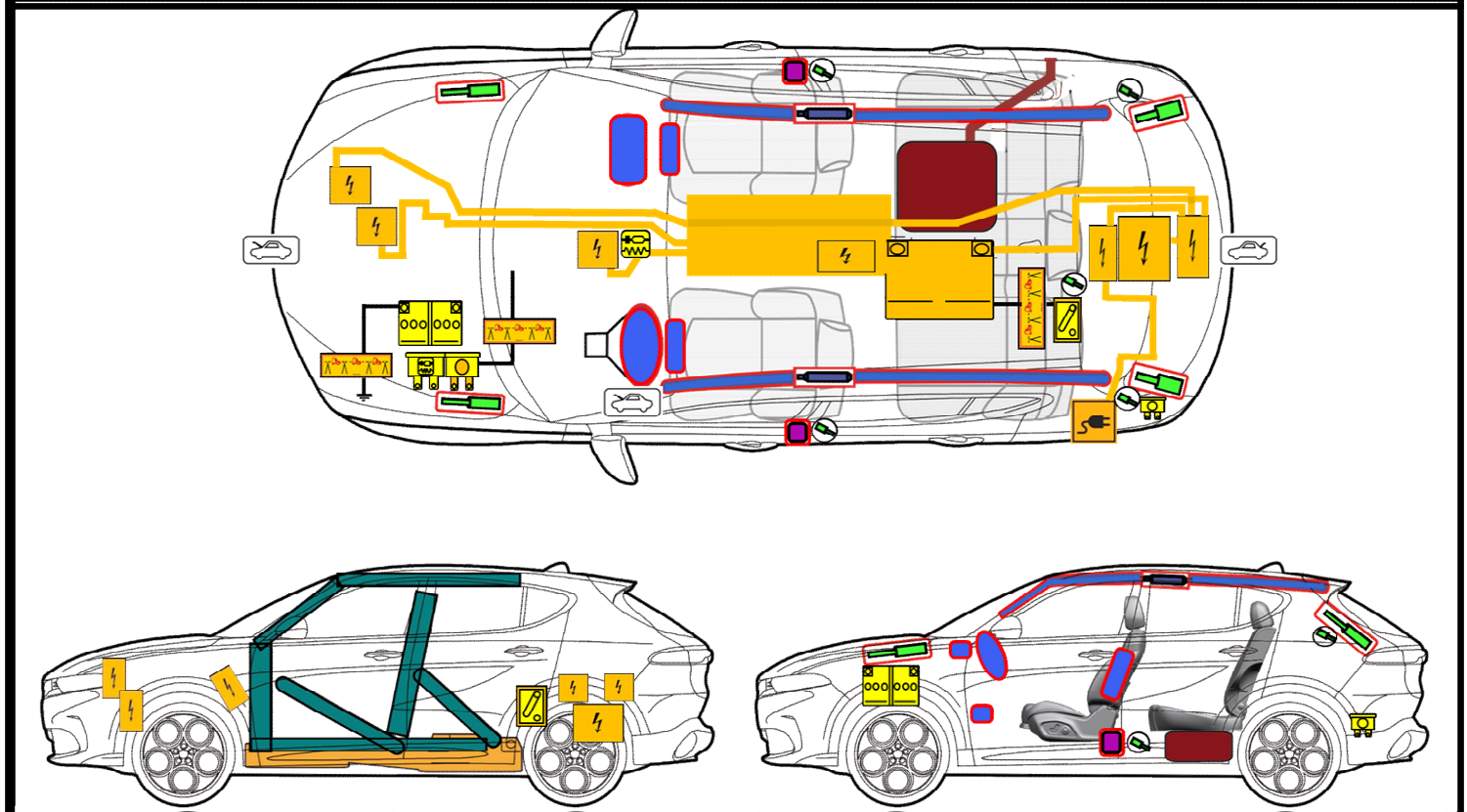

ISO 17840-1 PICTOGRAMS		PEDESTRIAN PROTECTION DEVICE		OCCUPANT/CURTIAN/BOLSTER AIR BAG AND INFLATOR		AIR BAG INFLATOR		SEATBELT PRETENSIONER		AUTOMATIC ROLL-OVER PROTECTION
		LOW VOLTAGE BATTERY		GAS STRUT, PRE-LOADED SPRING, BELT RETRACTOR		RESTRAINT SYSTEM CONTROL MODULE		HIGH STRENGTH ZONE		SAFETY VALVE
		HIGH VOLTAGE BATTERY PACK		LOW VOLTAGE ULTRA-CAPACITOR		FUEL TANK		COMPRESSED GAS TANK		SAFETY VALVE CONTROL VALVE
		HIGH VOLTAGE DISCONNECT		HIGH VOLTAGE CABLE		VEHICLE CHARGE PORT		LOW VOLTAGE FUSE BOX		DISABLING HIGH VOLTAGE
ISO 17840-3 AND OTHER PICTOGRAMS		ENGINE ACCESS LATCH		LOW VOLTAGE DISCONNECT		VEHICLE INDUCTION CHARGING		HIGH VOLTAGE COMPONENT		RESPONDER CUT-LOOP
		DISCONNECT HIGH VOLTAGE VIA LOW VOLTAGE		SOLAR PANEL		HIGH VOLTAGE FUEL CELL		FUEL TANK WITH DIESEL FUEL		LOW VOLTAGE FUSE BOX
		FUEL TANK WITH GASOLINE OR ETHANOL		FUEL TANK WITH BIO-FUEL		HIGH VOLTAGE FUSE BOX		LOW VOLTAGE FUSE BOX		DISABLING SRS

Standard procedure to disable 12 V and High Voltage (HV) power

To disable external power to the vehicle complete step 1. To disable 12 V power from the Vehicle Systems and to disable HV Battery power external from the HV Battery complete steps 2 THRU 4. Step 5 allows the charge on HV capacitors to be discharged.

The following steps must be completed in numeric order:

1. Unplug the EVSE Recharge Coupler from the Vehicle Charge Receptacle, this will stop the AC power transfer to the vehicle. Press the Recharge Coupler LEVER and pull to remove.



Press in the EVSE Recharge Coupler Lever and pull to remove EVSE AC power from the vehicle.

This removes externally supplied high voltage power from the vehicle.

2. Turn off the Ignition switch by pressing stop button, this will start the process of disabling 12 V and HV power. Remove the key fob and relocate it at least 20 feet away from the vehicle.

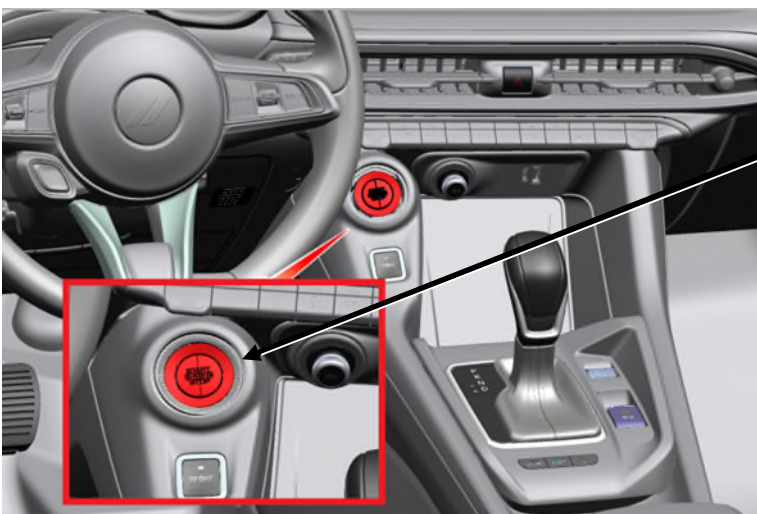

Press stop button to turn off.

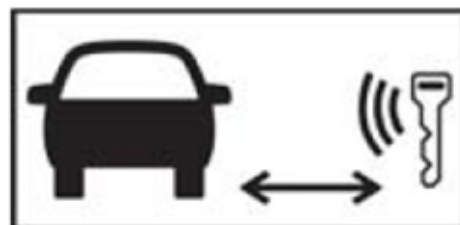

This starts the normal shut-down of low and high voltage power.

3. Physically cut the 12V power at the front of vehicle, this will disable HV power external of the HV battery and some 12V systems, including the airbags. Under the hood, on the driver side rear, locate the 12V battery ground cable located on the forward edge of the 12V Battery. Unplug or Cut a section of the 12v Battery ground cable marked with the first responders label (C). Then locate the red battery lid (E) and remove it. Cut and remove the segment of the 12V positive cable marked with the first responders label (F). Protect the cut ends of the positive cable from arcing against metal parts as the cable is live.

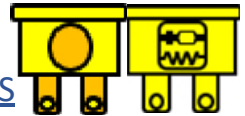

THIS STEP WILL DISABLE HIGH VOLTAGE POWER AND SOME 12V SYSTEMS

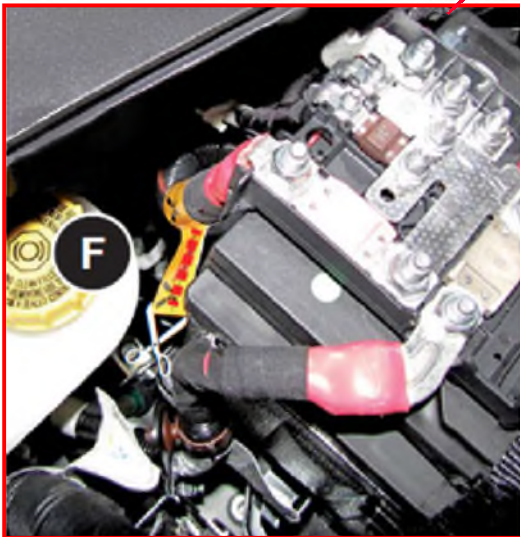

4. Physically cut the 12 V harness at the rear of vehicle, this is a secondary method to disable the high voltage systems only if the cut points in the front are not accessible. In the lift gate interior, remove the cargo load floor cover (B), remove the HV Test Lead Connector access cover (C). Cut and remove the segment of the 12V wire with the green and black wire harness connector (D) marked with the first responders label. Protect the cut ends of the positive cable from arcing against metal parts as the cable is live.

DO NOT CUT THE WIRE WITH THE ORANGE CONNECTOR.



WARNING: This method disables high voltage, but NOT LOW VOLTAGE-
Restraint system will remain powered

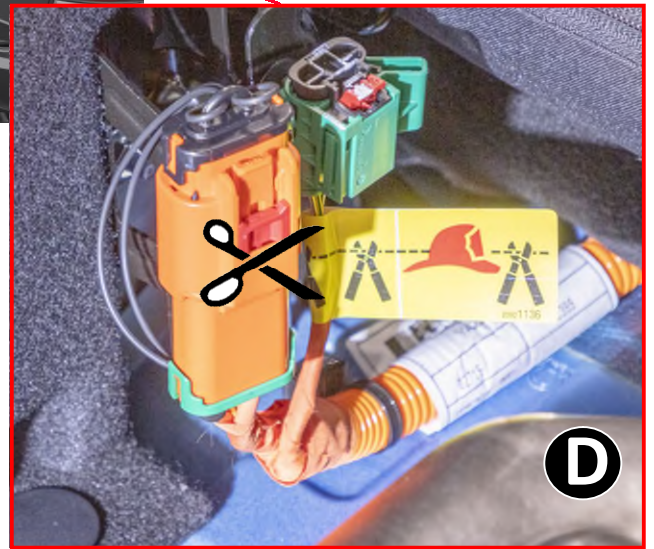
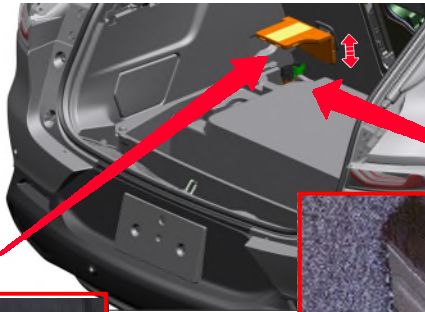

5. After completing the power-down steps above, wait 5 minutes before addressing a damaged vehicle.

This will allow the HV capacitors to discharge under most circumstances. However, under some circumstances the HV Battery System HV Contactors may not open. Consequently, HV may not be contained within the HV Battery System.

Personal Protective Equipment (HV qualified Gloves, Boots and Coat) provides protection against Live HV.

RECOMMENDED: First Responders must use Personal Protective Equipment when addressing a damaged Dodge Hornet Plug-In Hybrid.



WARNING: Even after completion of these steps, it is possible for High Voltage to still remain accessible outside of the battery pack in the event of damage to the current-interrupting mechanism. Always treat High Voltage components as if they remain energized.

Completion of steps 1 through 3 above will depower 12-volt systems and isolate high voltage energy within the high voltage battery system. Alternatively, completion of steps 1 & 4 will only isolate high voltage energy to within the battery pack. Restraint systems will remain powered.



WARNING: No attempt should be made to drain electrical energy from the high voltage battery pack in the field. This is a task that requires the specialized training and tools available to authorized service technicians. Contact with high voltage potentials, which is possible when attempting to connect to a damaged battery system, can cause serious or fatal injury.

Electrical PPE must be worn and contact with high voltage components avoided even after performance of these steps as a damaged vehicle system can behave in unexpected and/or undesired ways, including the continued presence of high voltage outside of the battery pack.

Impact event emergencies can require the extrication of victims from damaged vehicles. Determination of the need and timing to extricate must be made by incident command based on standard response practices and procedures.

RECOMMENDED: If safe to do so, remove victims from an electrified vehicle, as risk of injury from HV battery degradation can increase over time.

Potential HV electrical power system-related hazards to victims include:

- Fire, which is sustained by heat from a damaged battery or shorted wiring.
- Exposure to high voltage potentials caused by damage to the isolated HV system.
- Carbon monoxide and hydrogen fluoride emissions from a thermally active damaged battery, which can cause injury, blindness and death.
- Potentially explosive hydrogen emissions from a thermally active damaged battery.
- Unintended movement of the vehicle.

RECOMMENDED: Decisions to extricate must consider the balance between medical condition and hazard from the state of the vehicle.

Damage to fuel systems, hot coolant lines, all high voltage electrical components and cables, the batteries, and potentially active restraint systems must be avoided at all times. See the following pages for location information. (The “Do not cut” illustrations)

Engine Compartment Access:

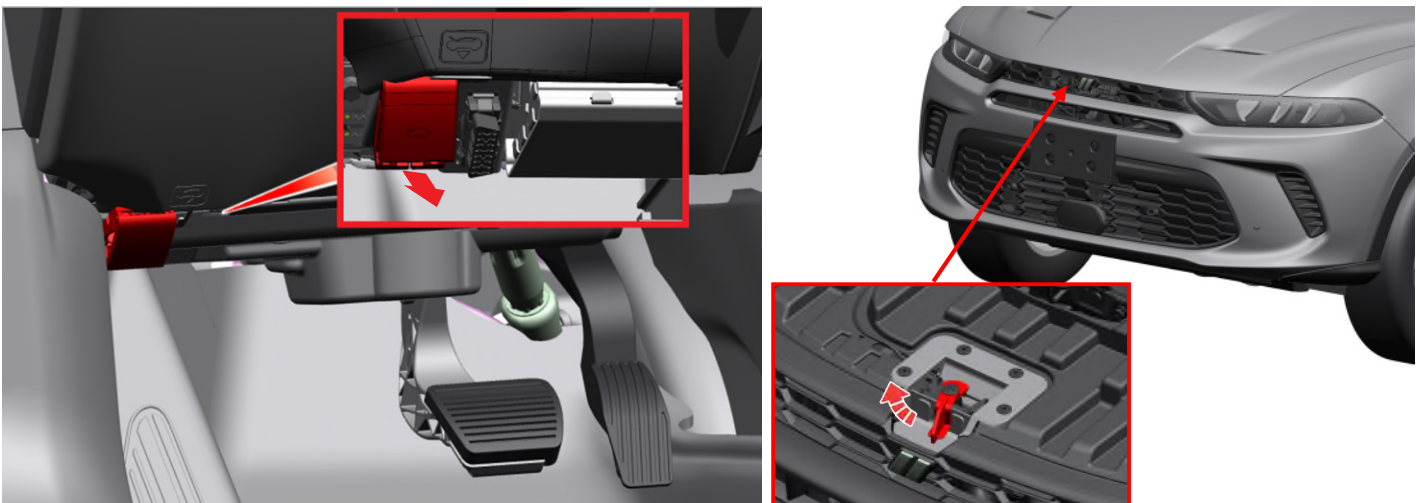

The hood release on the Dodge Hornet Plug-In Hybrid is located to the left of the steering wheel at the base of the lower dash panel. Placing fingers upward behind the edge at the flush inset lever handle, pull outward toward you. The hood will raise slightly and catch on the safety latch. Reach under the hood at the center and feel for the release lever. Push the lever toward the right side and the latch will release.

Recommended Cut Points for Extrication

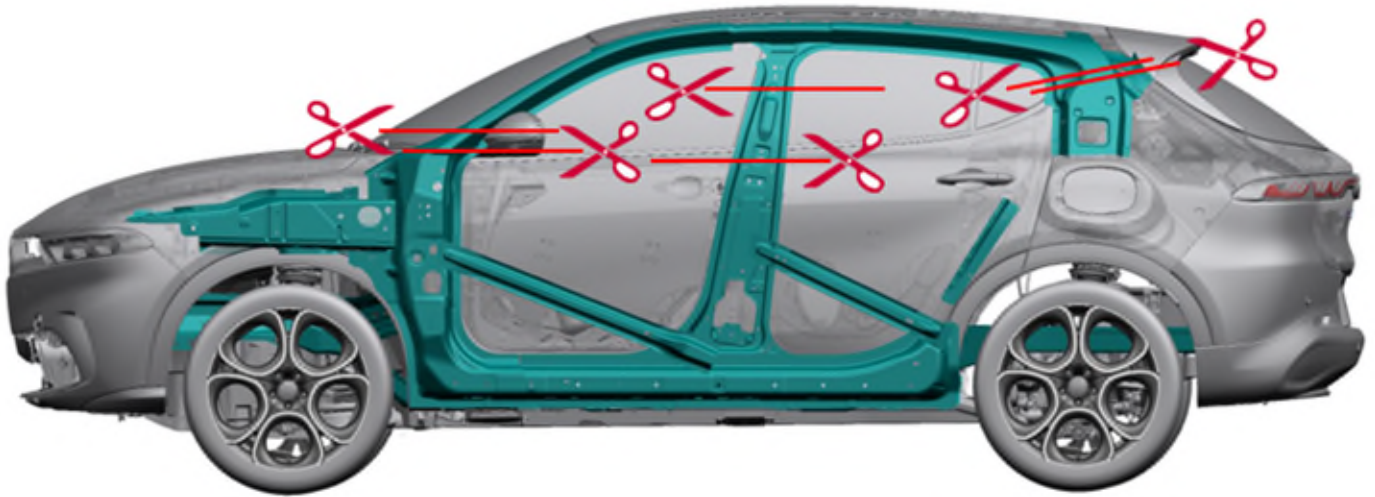

The areas illustrated between the scissor symbols are recommended cut zones on the vehicle. Determination of actual lift and cut points must be made by incident command based on the unique situational factors such as relocation of the hazards illustrated on the following pages as a result of impact events. These are only recommendations.

 **CAUTION:** Review the “DO NOT CUT” illustrations that follow to be aware of the original placement of components that may pose electrical, thermal, kinetic or other hazards during extrication operations.

DO NOT CUT into any high voltage cables or components. Avoid cutting primary low voltage electrical components as illustrated below.

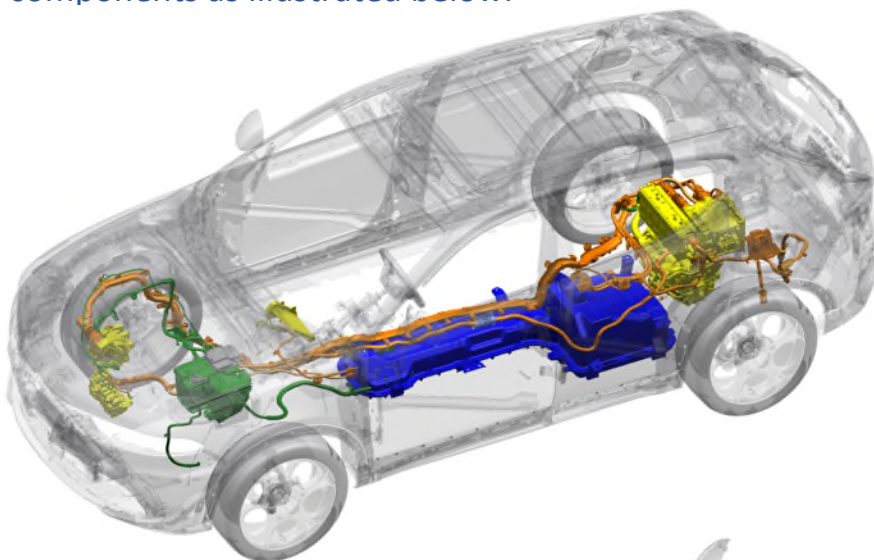

High voltage cables will be orange in color, while 12 Volt cables will be black, black/red, or bare mesh.

 **DO NOT CUT OR PEIRCE HIGH VOLTAGE DEVICES**

High Power Electrical Systems:

- High Voltage Cables
- High Voltage Components
- High Voltage Batteries
- Low Voltage (12V) Battery and Cables

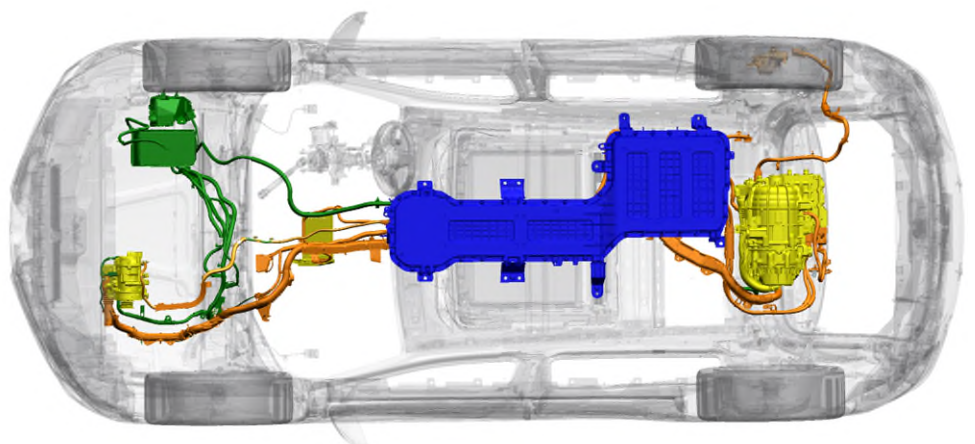

DO NOT CUT into any pressurized or combustible fluid component illustrated below.

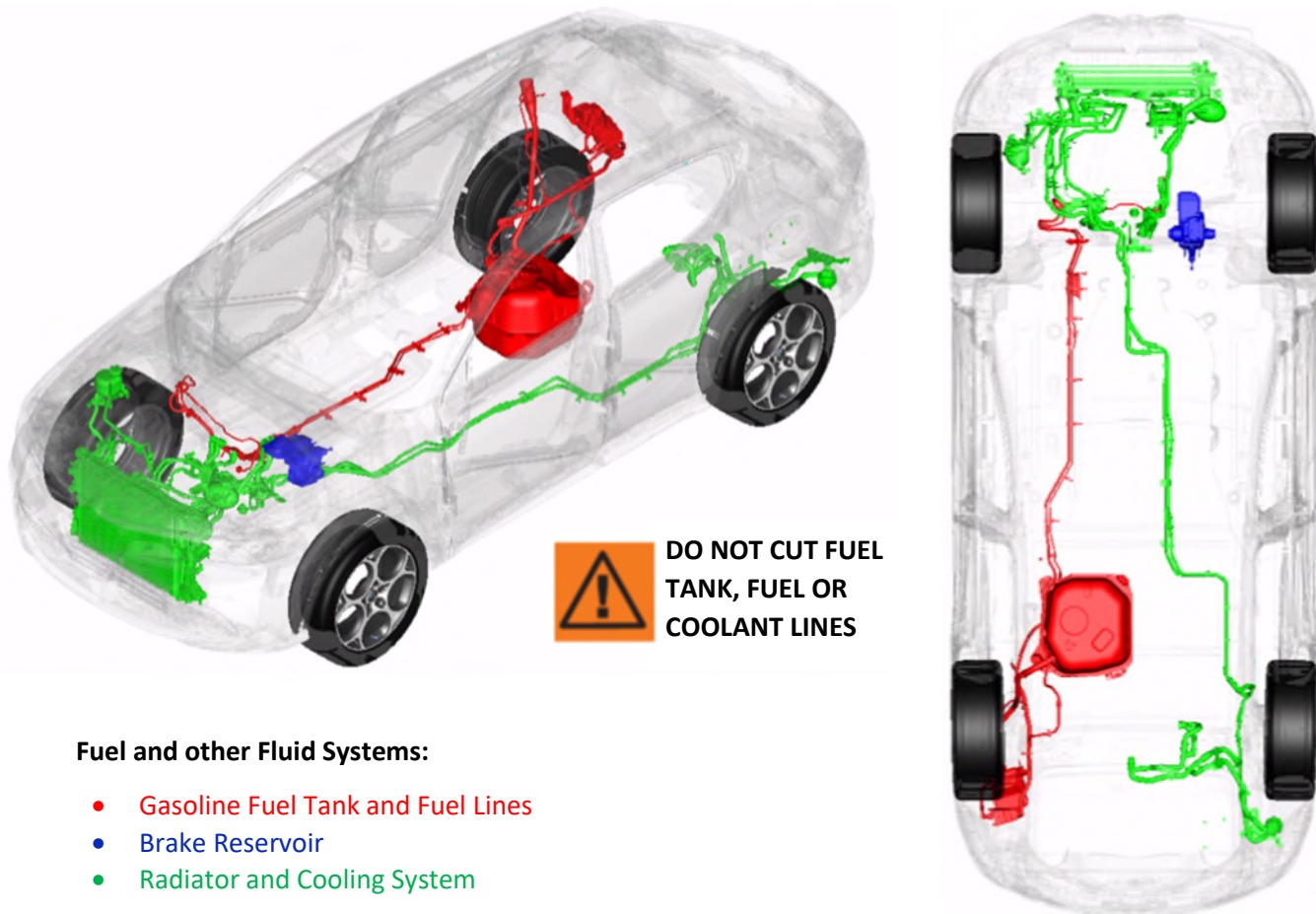

DO NOT CUT FUEL TANK, FUEL OR COOLANT LINES

Fuel and other Fluid Systems:

- Gasoline Fuel Tank and Fuel Lines
- Brake Reservoir
- Radiator and Cooling System

DO NOT CUT into occupant restraint components. (Fabric belts only may be cut with a knife)

Restraint Systems:

- Front seat belts with pretensioning devices (horizontal cylinder below the belt spool)
- Driver and front passenger air bags, seat-mounted side air bags and knee blocker air bags
- Impact sensors

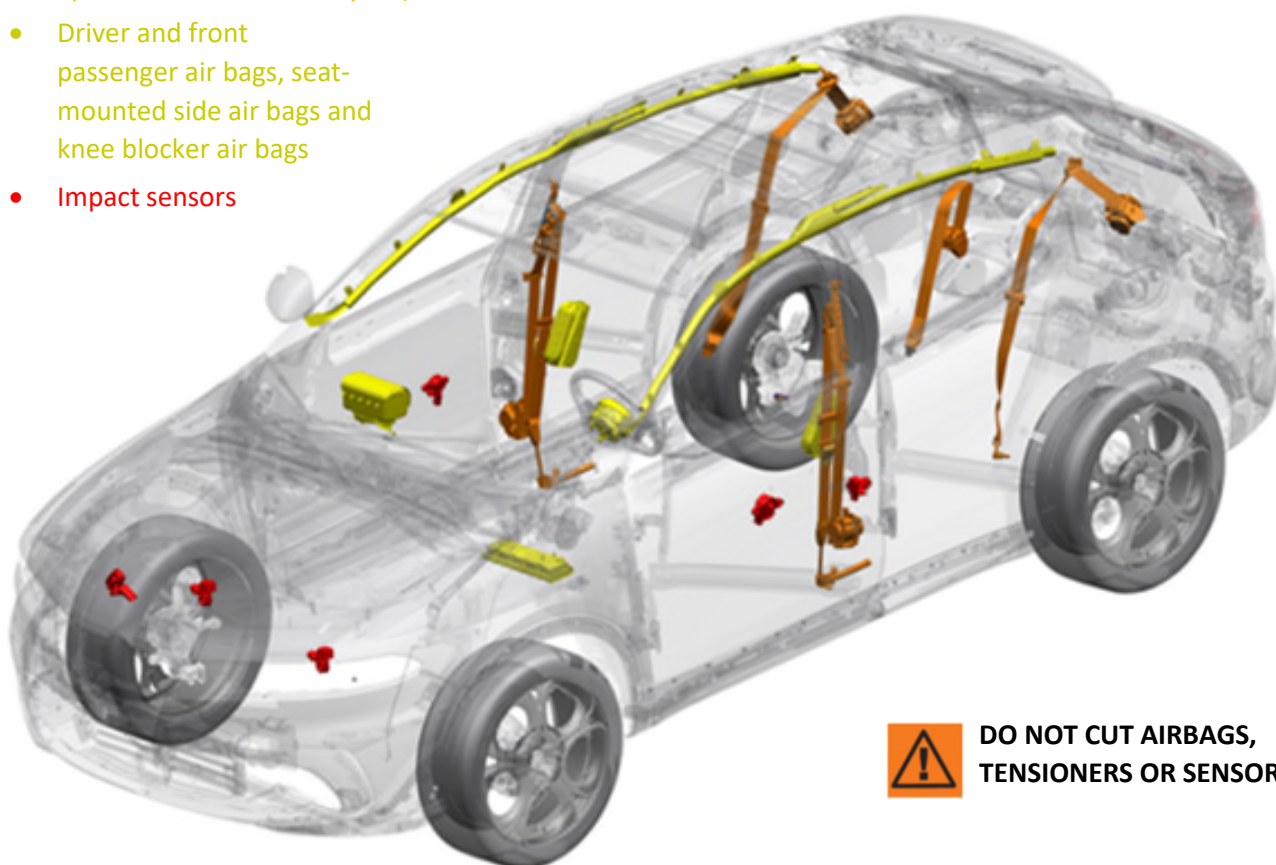

DO NOT CUT AIRBAGS, TENSIONERS OR SENSORS

Be advised that this vehicle includes select use of high-strength structural materials which may slow cutting and extrication efforts unless addressed with appropriate tools for such materials.

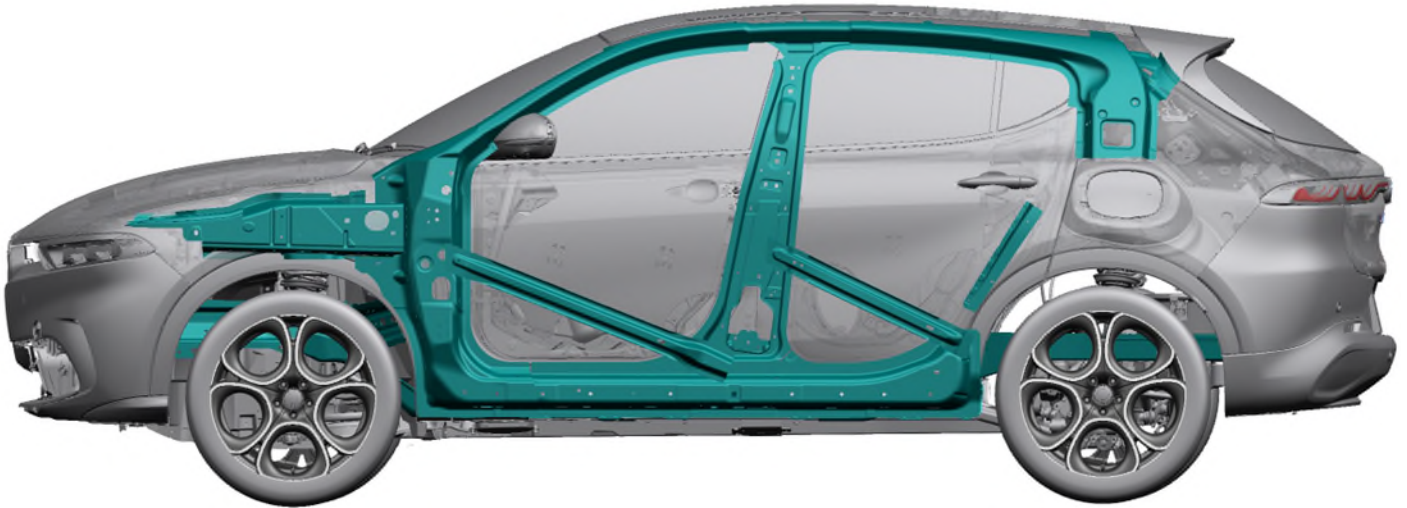

High strength steel components are illustrated in blue-green.

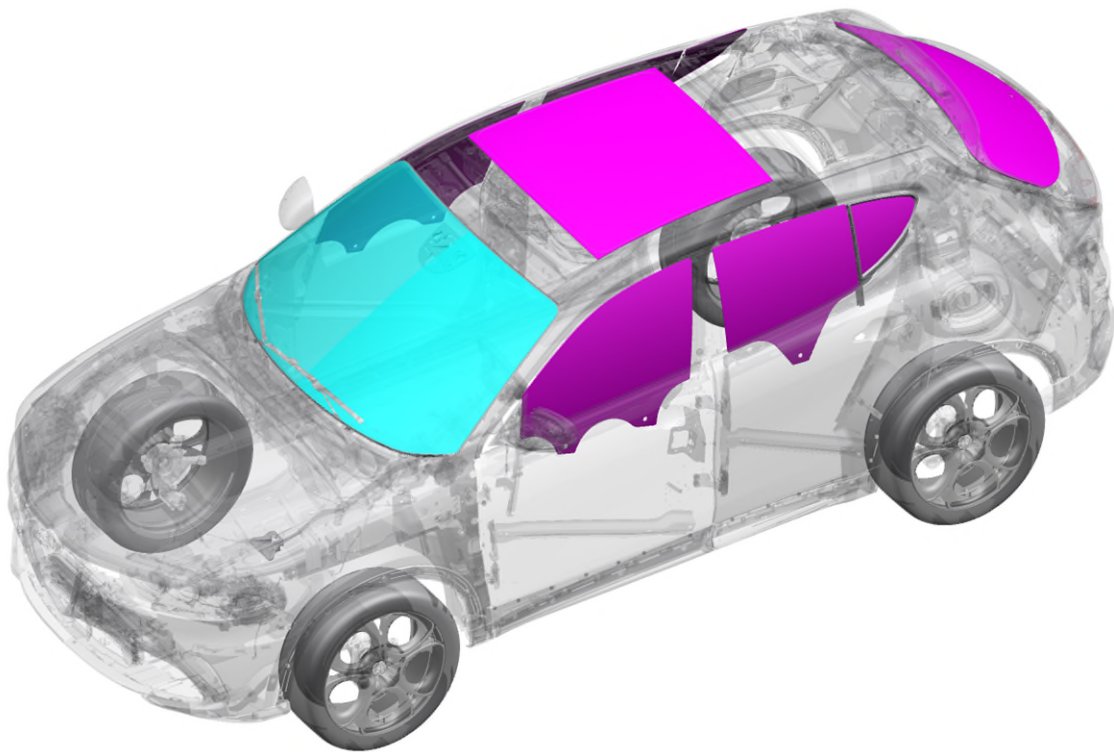

— LAMINATED GLASS is utilized in the windshield.

— TEMPERED GLASS is utilized in front doors, rear doors, lift gate and sunroof.

WARNING: Gaseous emissions from a thermally active damaged lithium-ion battery include hydrogen, which is explosive when mixed with oxygen in the air.



WARNING: Gaseous emissions from a thermally active lithium-ion battery include hydrogen fluoride which when combined with moisture in the human body forms an acid that can cause burns, respiratory distress and injury, blindness and/or death.



RECOMENDED: Immediately open all doors and remove all glass to maximize ventilation.

Under most circumstances, a high voltage battery at zero percent useable charge as shown on the dash still contains significant electrochemical energy. The state of charge as displayed does not indicate any lessening of electrical shock or thermal progression potential.



WARNING: Do not puncture, cut, apply heat to, drop, crush, or attempt to attach electrical conductors to, any high voltage battery system or component, as injury or death may result.



WARNING: The specialized equipment necessary to safely discharge a high voltage battery pack is not available in the field presently. **DO NOT** attempt to improvise a means of discharge, as severe injury or death may result.



Discharging the Dodge Hornet Plug-In Hybrid 400-volt battery below the minimum operating voltage (which shows on the dash as a zero percent charge) will do permanent damage to the battery and requires bypassing safety mechanisms as well as specialized training. Therefore, the high voltage energy should be contained exclusively within the battery pack in an incident response situation.

To contain high voltage energy within the battery pack, under most circumstances the procedures outlined in this guide will be sufficient. However, in rare cases, the isolation device internal to the battery system may have become damaged, in which case high voltage energy may only be contained within the battery pack by means of physically disconnecting all outputs from the battery pack and covering those connectors. This process is not recommended unless guidance from Stellantis personnel with knowledge relating to disconnecting and securing the battery pack in the specific model involved is available to responders. Contact the Stellantis battery engineering team for guidance in this regard.



WARNING: Even after completion of these steps, it is possible for High Voltage to still remain accessible outside of the battery pack in the event of damage to the current-interrupting mechanism. Always treat High Voltage as if they remain energized.

RECOMENDED: First Responders must use Personal Protective Equipment when addressing a damaged Dodge Hornet Plug-In Hybrid. Treat all high voltage components as if energized at all times.

WARNING: 12 volt batteries contain sulfuric acid, which can cause burns and blindness on contact, and which may be lethal if ingested.



12 VOLT BATTERIES also contain trapped electrical energy of a low voltage potential. While these do not present a shock hazard, sparks and arcs of significant energy are possible, and can ignite volatile fuel vapors at an accident scene. To reduce risk of accidental ignition, 12V



battery terminals may be stripped of all connections and covered as soon as safely possible following primary response activities.

PRESSURIZED FLUIDS: Exist in multiple systems within the Dodge Hornet Plug-In Hybrid.

These systems include:

- Engine Cooling System and Radiator
- Power Electronics Cooling System
- Brake System
- Power Steering System
- Fuel System



RECOMMENDED: Avoid cutting into any tubing or components associated with these systems, as fluids may be ejected under pressure, and potentially at high temperature.

WARNING: Fuel is flammable, and hydraulic oil is combustible. These liquids may stick to or sink into clothing, acting as an accelerant if ignited.



The fuel system in the Dodge Hornet Plug-In Hybrid is pressurized to protect against air pollution.

WARNING: The fuel system is pressurized. If the system is ruptured, gasoline vapors will escape which have the potential to detonate if exposed to a source of ignition.

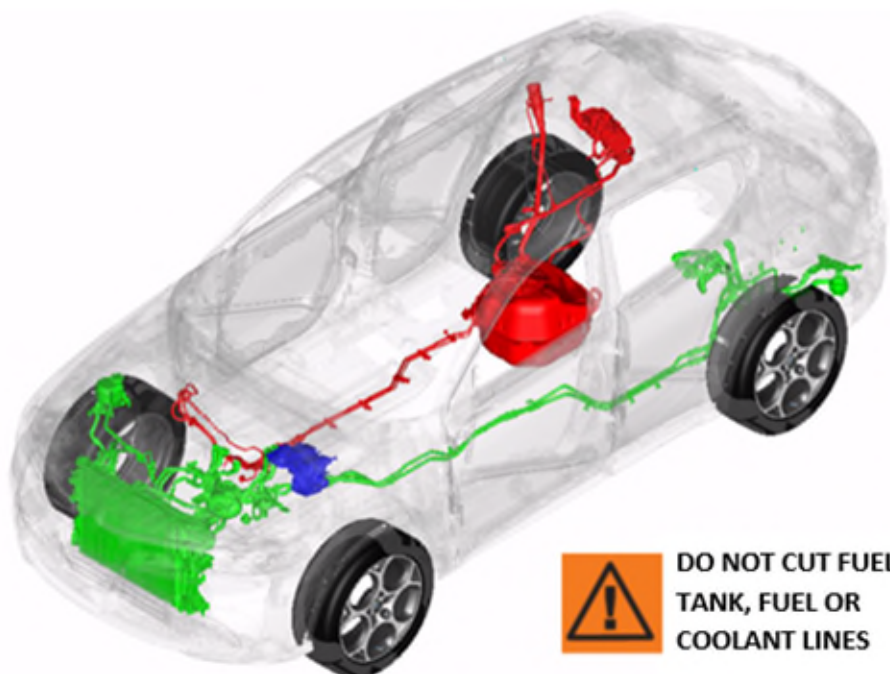

DO NOT CUT FUEL TANK, FUEL OR COOLANT LINES

Fuel and other Fluid Systems:

- Gasoline Fuel Tank and Fuel Lines
- Brake Reservoir
- Radiator and Cooling System

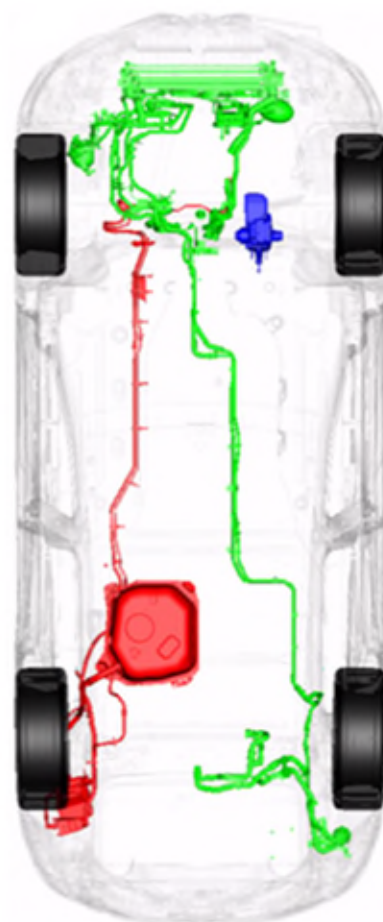

RESTRAINT SYSTEMS utilized in the Dodge Hornet Plug-In Hybrid include two distinct sets of devices that contain “trapped energy” unless damaged or consumed. These are the seat belt retractors, and the systems that deploy various restraints upon impact.



Seat belt retractors utilize a wound spring that maintains a constant pull on the seat belt. Even when retracted, the spring is still under load. If damaged, it can shatter throwing sharp metal debris.



WARNING: Do not cut into seat belt retractor mechanisms, as injury or blindness may result.

Airbag and bolster actuators are, typically one-time-use, explosive devices used to rapidly inflate restraint devices on impact. Undeployed actuators can be triggered electrically by impact sensors, thermally, or sometimes by interaction with a cutting device passing into them.



Seatbelt Pretensioners employ a typically one-time-use explosive device to properly position the occupant for airbag deployment. These are a similar hazard to the airbag actuators, but can also propel metal components, or simply retract an inconveniently placed belt, with the associated risk of injury.



WARNING: Do not cut, puncture, heat, crush, or strike airbag or bolster inflators, impact sensors, or seatbelt pretensioners, as inadvertent detonation may result in injury or death.

Restraint Systems:

- Front seat belts with pretensioning devices (horizontal cylinder below the belt spool)
- Driver and front passenger air bags, seat-mounted side air bags and knee blocker air bags
- Impact sensors

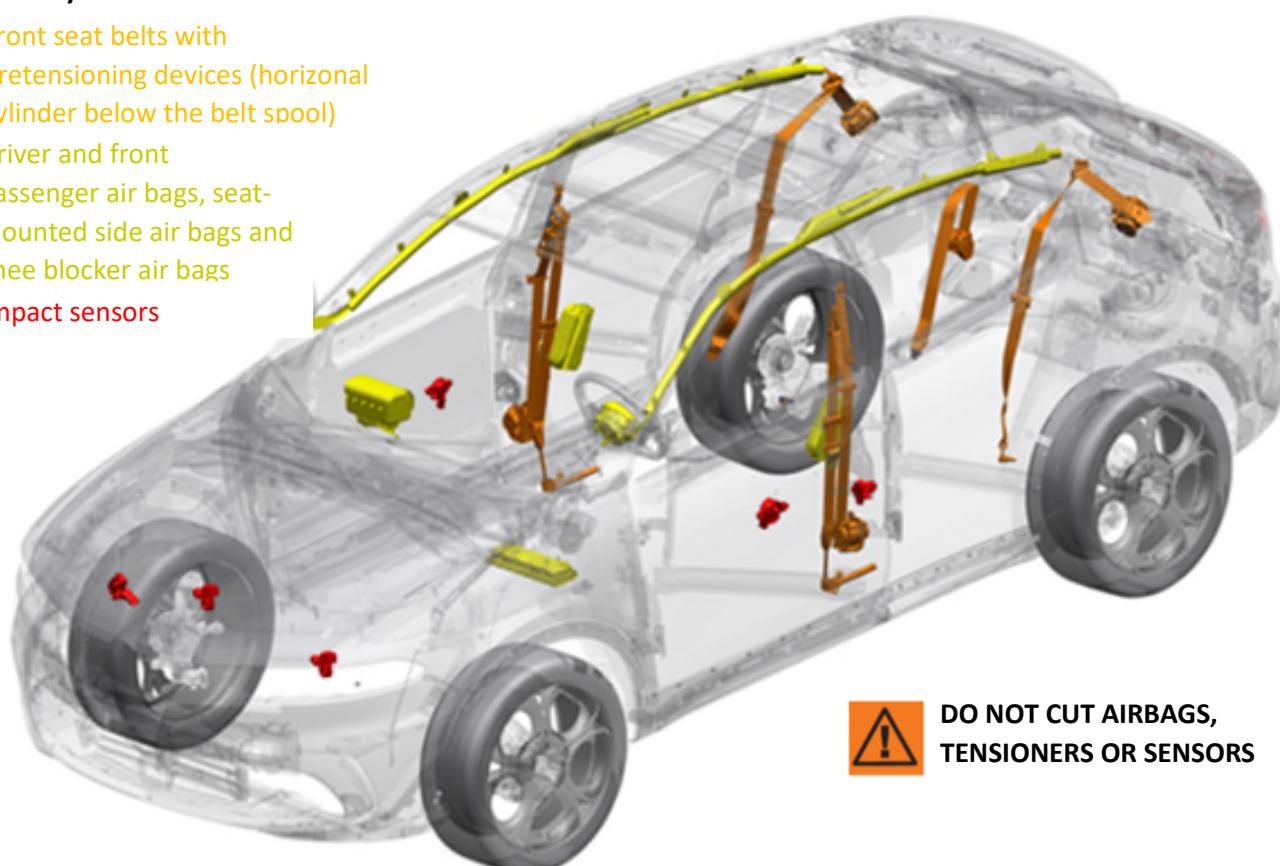

DO NOT CUT AIRBAGS, TENSIONERS OR SENSORS

The Dodge Hornet Plug-In Hybrid includes a high voltage lithium-ion battery system. As a result, special consideration must be given to extinguishing methods and practices.

Fighting electrified driveline vehicle fires poses unique challenges.

- Chemical extinguishers and oxygen denial are not effective in these fires.
- Deluge with water delivered via fire hose at the maximum possible distance is the recommended practice to contain the fire and cool the reagents, minimizing risk of spread and risk of hazardous emissions. This should continue after extinguishment until the pack is cool.
- Ventilation of the passenger compartment, if occupied, is essential at the first sign of battery heating, smoke or fire.
- Batteries should be thermally assessed during initial operations and throughout rescue and remediation efforts.
- Damage, abuse, flooding or exposure to heat (such as from a vehicle fire) can initiate thermal reactions which will advance to a significant fire in lithium ion power systems.
- The Battery thermal reactions become self-sustaining at higher temperatures due to the emission of oxygen from certain constituents.
- Ongoing battery fire or heat production can facilitate the re-ignition of combustible automotive components above and adjacent to the pack.
- Lithium-ion automotive batteries can reignite due to ongoing reactions from internal heat.
- For any battery thermal event, NFPA recommends SCBA be required within fifty feet.



WARNING: Never cut, pierce or damage any high voltage component as severe injury or death may result.



WARNING: Emissions from a thermally active lithium-ion battery include moisture in the human body forms an acid that can cause tissue burns, respiratory distress and injury, blindness and/or death.



RECOMMENDED: Application of large amounts of water should begin at the first signs of battery smoke as water may absorb some harmful toxic emissions in the smoke.

RECOMMENDED: Immediately open all doors and remove all glass to maximize ventilation.

RECOMMENDED: Rescue of persons at risk and containment of the fire with prevention of hazardous gas emissions should be the goals of fire-fighting efforts.

RECOMMENDED: An infrared thermometer should be used to assess the battery's thermal activity.



A vehicle submerged or flooded with water can result in protective system failures.



Excessive heat and electrolysis may take place resulting in byproducts of hydrogen and oxygen. In salt water, chlorine is also a byproduct. These byproducts, trapped and concentrated by the passenger compartment, a



garage, or other containment, may be in concentrations that could be explosive or corrosive and could have adverse effects on human health. Action should be taken to ensure ventilation of a partially submerged vehicle and any space in which it is contained.

For a Dodge Hornet Plug-In Hybrid that is without physical damage (such as from an accident) the risk of electrical shock when submerged or flooded is not increased.



WARNING: A vehicle with impact damage presents an increased electrical shock hazard risk. If HV is open to the environment, you must stay away from damaged HV components.

RECOMMENDED: Responders must use proper Personal Protective Equipment when addressing a damaged Dodge Hornet Plug-In Hybrid vehicle.

When removing an undamaged vehicle:

TOWING CONDITION	WHEELS OFF THE GROUND	ALL-WHEEL DRIVE (AWD)
Flat Tow	NONE	NOT ALLOWED
Dolly Tow	REAR	NOT ALLOWED
	FRONT	NOT ALLOWED
On Trailer	ALL	BEST METHOD

TOWING CONDITION	WHEELS OFF THE GROUND	ALL-WHEEL DRIVE (AWD)
When towing your vehicle, always follow applicable state and provincial laws. Contact state and provincial Highway Safety offices for additional details.		

Proper towing or lifting equipment is required to prevent damage to your vehicle. Use only tow bars and other equipment designed for this purpose, following equipment manufacturer's instructions. Use of safety chains is mandatory. Attach a tow bar or other towing devices to main structural members of the vehicle, not to fascia/bumper or associated brackets. State and local laws regarding vehicles under tow must be observed.

NOTE:

- You must ensure that the Auto Park Brake feature is disabled before towing this vehicle to avoid inadvertent Electric Park Brake engagement. The Auto Park Brake feature is enabled or disabled via the customer programmable features in the Uconnect Settings.
- Vehicles with a discharged battery, or total electrical failure when the Electric Park Brake (EPB) is engaged, will need a wheel dolly or jack to raise the rear wheels off the ground when moving the vehicle onto a flatbed.

If you must use the accessories (wipers, defrosters, etc.) while being towed, the ignition must be in the ON/RUN mode.

Note that the Safehold feature will engage the Electric Park Brake whenever the driver's door is opened (if the battery is connected, ignition is ON, transmission is not in PARK, and brake pedal is released). If you are towing this vehicle with the ignition in the ON/RUN mode, you must manually disable the Electric Park Brake each time the driver's door is opened by pressing the brake pedal and then releasing the EPB.

If the vehicle's battery is discharged, instructions on shifting the automatic transmission out of PARK so that vehicle can be moved.

The above towing chart covers multiple drive configurations. **The Dodge Hornet Plug-In Hybrid is an All-Wheel Drive Model.**

Towing of an undamaged vehicle is permitted with all four wheels on the ground and the transmission in PARK only. This vehicle is not designed to support "dolly tow" with only one set of wheels in contact with the road.

RECOMMENDED: Transporting of an Dodge Hornet Plug-In Hybrid by flatbed truck or trailer is the preferred method.



WARNING: You or others could be injured or killed if you leave the vehicle unattended with the gear selector in the N (NEUTRAL) position without first fully engaging the parking brake. The gear selector N (NEUTRAL) position disengages both the front and rear driveshafts from the powertrain and will allow the vehicle to roll. The parking brake should always be applied when the driver is not in the vehicle.



For trailer or flat-bed truck transport (preferred):

- Secure the vehicle to the means by which it will be loaded onto the trailer or flatbed.
- Set the transmission by shifting the gear selector shifter to (N) neutral. The vehicle will roll freely if the parking brake is released.
- Roll the vehicle onto the trailer or flatbed.
- Secure the vehicle to the trailer or flatbed for transit.



WARNING: After transit, the vehicle will roll freely until the shifter is shifted out of (N) neutral. Do not unsecure without a means of preventing unintended motion.

Neutral Shifting for Transmission Instructions:



CAUTION: It is necessary to follow these steps to be certain that the transmission is fully in (N) Neutral before towing to prevent damage to internal parts.

Shifting the vehicle into N (NEUTRAL):

1. Bring the vehicle to a complete stop on level ground with the engine running.
2. Press and hold the brake pedal.
3. Press in and hold the front button on the shift handle lever and shift the automatic transmission into NEUTRAL (N).



NOTE:

- The ignition switch must be in the ON/RUN position for a shift to take place and for the position indicator lamp to be operable. If the ignition is not in the ON/RUN position, the shift will not take place and no position indicator lights will be on or flashing.

4. With the transmission in N (NEUTRAL), push and hold the ENGINE START/STOP button until the engine turns off.
5. Place the transmission gear selector in PARK. Release the brake pedal.
6. Push the ENGINE STOP/START button twice (without pressing the brake pedal). To turn the ignition to the off position.

7. Attach the vehicle to the tow vehicle using a suitable tow bar.
8. Release the parking brake.

Shifting the transmission out of N (NEUTRAL):

1. Bring the vehicle to a complete stop, leaving it connected to the tow vehicle.
2. Firmly apply the parking brake.
3. Start the engine.
4. Press and hold the brake pedal.
5. Shift the transmission into PARK (P).
6. Turn the engine off.
7. Release the brake pedal.
8. Disconnect vehicle from the tow vehicle.
9. Start the engine.
10. Press and hold the brake pedal.
11. Release the parking brake.
12. Shift the transmission into REVERSE or DRIVE, release the brake pedal and check that the vehicle operates normally.



CAUTION:

- Front or rear wheel lifts must not be used (if the remaining wheels are on the ground). Internal damage to the transmission will occur if a front or rear lift is used when towing.
- Do not use sling type equipment when towing. Vehicle damage may occur.
- Towing this vehicle in violation of the above requirements can cause severe transmission damage. Damage from improper towing is not covered under the New Vehicle Limited Warranty.



When removing a damaged vehicle and remediating the area after an incident:

FLUIDS: The Dodge Hornet Plug-In Hybrid battery is a “non-spillable” qualifying architecture. Battery electrolyte remains trapped in the internal elements of the electrical cells. Liquid spilled from a high voltage battery pack is primarily engine coolant.

Collect spilled fluids for disposal as follows:

- Collect spilled engine coolant and any coolant from electronic systems in the normal manner for spilled glycol/water mix.
- Collect spilled engine and hydraulic oil with absorbent material and use detergents to recover from masonry. Collect contaminated ground for disposal in accordance with local requirements as applicable.
- Collect spilled gasoline in the same manner as oils but employ precautions for the management of flammable and explosive vapors.
- Collect spilled 12 V battery electrolyte with an absorbent that neutralizes the highly acidic sulfuric acid electrolyte. Do not handle 12 V battery electrolyte, or materials contaminated with 12 V battery electrolyte without chemically resistant protection.



BATTERY PACK DEBRIS: In the event of significant damage to and fragmentation of the high voltage battery pack, all debris should be collected and disposed of. While not classified as a hazardous waste, skin contact with battery pack internal elements is to be avoided.

POST-INCIDENT DELIVERY TO SERVICE: If airbags have deployed, the vehicle cannot be driven again until repaired, as airbag protection will not be available to occupants in the event of a collision. After any collision, the vehicle should be taken to an authorized dealer immediately.



VEHICLE MOVEMENT: The rotation of the wheels at more than creep speeds can cause the generation of electrical energy in damaged vehicles. This may reach high voltage potentials. Additionally, in damaged systems with remaining propulsion ability, movement of the wheels could trigger a driveline response and result in unexpected movement of the vehicle.
DO NOT PUSH BY HAND.



DO NOT TOW WITH WHEELS ON THE GROUND



FLATBED/TRAILER TOW ONLY

PREPARATION FOR TOWING: The relocation of a damaged vehicle must be by means of a trailer, flatbed or similar conveyance that will not allow rotation of the drive wheels. For loading, ideally drag the drive wheels in a locked position, or if drive wheels must rotate, move the car at speeds of no more than 12 feet per minute.



WARNING: During preparation, transport and storage, isolation and observation of the vehicle, particularly the high voltage battery pack, is necessary to watch for, and react to, any signs of delayed ignition or re-ignition of the battery pack.



RECOMMENDED: An infra-red thermometer should be used to assess the battery's thermal activity.

Damaged vehicle towing instructions:

- Secure the vehicle to the means by which it will be loaded onto the trailer or flatbed.
- Set the transmission to PARK and the transfer case shifter to any setting other than (N) neutral. Set the parking brake. This will lock the wheels in place and require dragging the vehicle to load.
- Drag the vehicle onto the trailer or flatbed.
- Secure the vehicle to the trailer or flatbed for transit.



WARNING: If the transmission were left in (N) neutral, the vehicle will roll freely when not secured. Do not unsecure without a means of preventing unintended motion.

If circumstances require that the damaged vehicle be allowed to roll, such must be kept to a minimum and at creep speeds only. If 12-volt power is disabled, and the vehicle is in PARK, it will be necessary to follow these steps:



WARNING: You should be seated in the driver's seat with your foot firmly on the brake pedal to maintain control of the vehicle before activating the GEAR SELECTOR OVERRIDE. If possible, you should apply the parking brake. Activating the GEAR SELECTOR OVERRIDE will allow the vehicle to roll away if not secured or properly connected to a tow vehicle. Activating the GEAR SELECTOR OVERRIDE on an unsecured vehicle could lead to serious injury or death for those in or around the vehicle.

1. Turn the engine off.
2. Apply firm pressure to the brake pedal while seated in the driver's seat.
3. Apply the parking brake, if possible.
4. Grab the boot material of the gear selector and pull up to carefully separate the gear selector bezel and the boot assembly from the floor console.
5. Maintain firm pressure on the brake pedal.

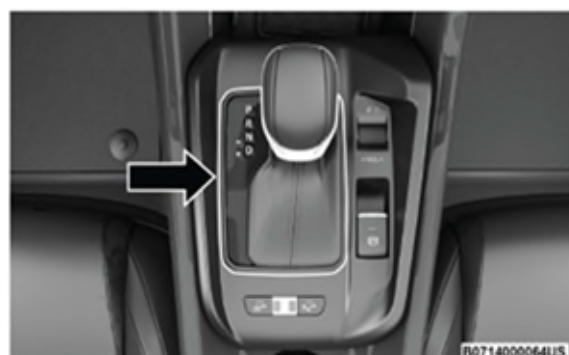

Gear Selector Bezel

6. Locate the gear selector override (at the right rear corner of the gear selector assembly). Using a small screwdriver or similar tool, push and hold the override release lever down



Gear Selector Override Access Location

7. Move the gear selector to the NEUTRAL (N) position.
8. The vehicle may then be started in NEUTRAL.
9. If engaged, release the parking brake only when the vehicle is securely connected to a tow vehicle.

POST-INCIDENT HANDLING:

Following initial response, certain actions and precautions are necessary. If airbags have deployed, the vehicle cannot be driven again until repaired, as airbag protection will not be available to occupants in the event of a collision. After any collision, the vehicle should be taken to an authorized dealer immediately.

While the Dodge Hornet Plug-In Hybrid HV battery is designed for safety, industry-wide experience has demonstrated that the unlikely possibility of delayed ignition or re-ignition of a damaged battery must be considered in post-incident handling. Any battery exposed to accident forces sufficient to deploy airbags or to a vehicle fire requires special precautions until verified as undamaged.

- The vehicle or battery pack must not be stored inside a structure, occupied or otherwise.
- Adequate ventilation must be present at the storage location to prevent buildup of any outgassing.
- Batteries to be recycled must be shipped in accordance with regulations governing the transport of damaged lithium-ion batteries (and never by air).
- Thermal monitoring of any damaged, flooded or burned battery should be performed during storage.
- Do not leave any openings into the battery pack, such as a fuse or other access cover, removed. Openings in the housing could allow water to enter the battery pack and create a hazard.
- The battery pack in this vehicle uses non-spillable lithium-ion cells, and it is unlikely that electrolyte, which is clear, will escape from the pack in the event of damage. Liquid emissions from damaged packs are typically colored battery coolant, which should be addressed in the same manner as spilled engine coolant.
- Do not apply chemical neutralizers used for other battery types to Lithium-ion battery components or take any other action which could result in battery cell contents being aerosolized.

Do not ingest, inhale, or make bare skin contact with any internal material from the battery cells. In the event of accidental contact of this nature, wash exposed skin thoroughly with soap and water for at least 5 minutes and seek medical attention. In the event of ingestion, seek emergency medical care immediately.

Stellantis / FCA US Customer Center: (877) 426-5337

Stellantis / FCA Canada Customer Center: (800) 465-2001 (English) (800) 387-9983 (French)

Stellantis / FCA Mexico Customer Center: +(52) 55 50817568

Stellantis / FCA within Mexico City only: (800) 505-1300

Stellantis / FCA Caribbean Customer Center: (877) 426-5337

Service Manuals are available in the US and Canada from Tech Authority: (800) 890-4038

The Dodge Hornet Plug-In Hybrid is designed and built with a focus on protecting both our customers and the environment. Nonetheless, when vehicles are damaged or catch fire, a number of substances are released which may be harmful to life or the environment. Obtaining material safety information in accordance with your organization’s practices may be useful with regard to:

Gasoline	Lead	Hydrogen	Methyl Carbonate
Ethanol	Sulfuric Acid	Hydrogen Fluoride	Ethyl Carbonate
Ethylene Glycol	Hydrogen Sulfate	Hydrofluoric Acid	
Hydraulic oils	Vinyl Chloride	Benzene	
Motor oil	Chlorine gas	Pentafluoral Phosphate	

RECOMMENDED: The use of SCBA within 50 feet of any vehicle event involving a thermally active lithium-ion battery pack, including following initial extinguishing activity, is recommended by NFPA as well as by Stellantis.

	GASOLINE-ELECTRIC VEHICLE		IMPORTANT INFORMATION		ELECTRICAL SHOCK HAZARD
	RISK OF FIRE		RISK OF EXPLOSION		HARMFUL OR LETHAL TO HUMAN HEALTH
	CORROSIVE SUBSTANCE		RISK OF INJURY		LITHIUM-ION BATTERY—HANDLE APPROPRIATELY
	DO NOT PUSH VEHICLE		RELOCATE KEY FOB AWAY FROM VEHICLE		RISK OF THERMAL ACTIVITY FROM BATTERY SYSTEM
	FLATBED/TRAILER TOW ONLY		DO NOT TOW WITH WHEELS ON GROUND		

3-Dimensional illustrations utilized in this guide are constructed as if the bulk of the vehicle is semi-transparent, with the components of interest shown in solid color.

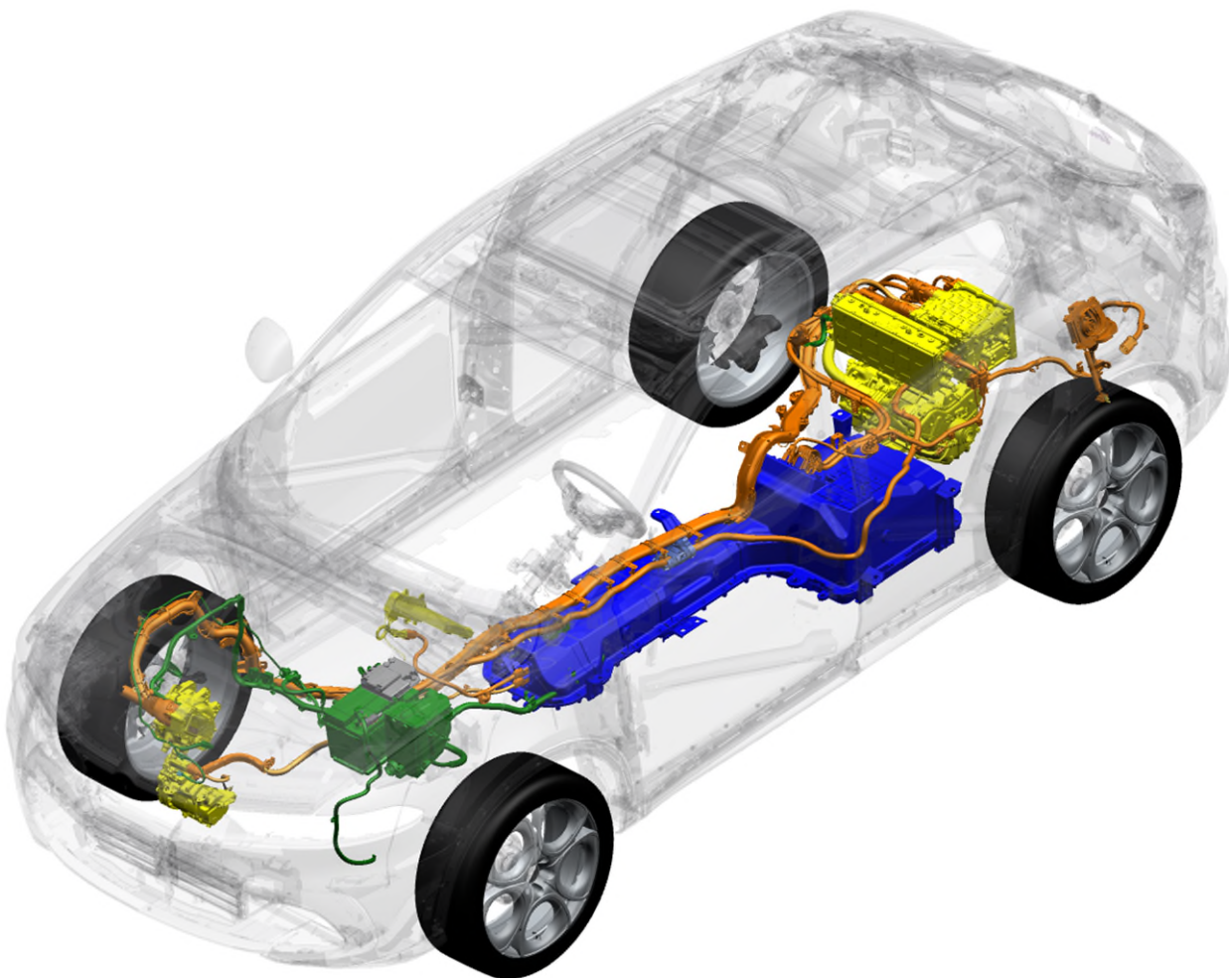

These illustrations are intended to convey the location of the components of interest within the 3-dimensional form of the vehicle to aid responders in estimating where those components lie within the vehicle with which they are presented – recognizing that it may be in a different form.