

Mopar[®]

PARTS & ACCESSORIES CATALOG

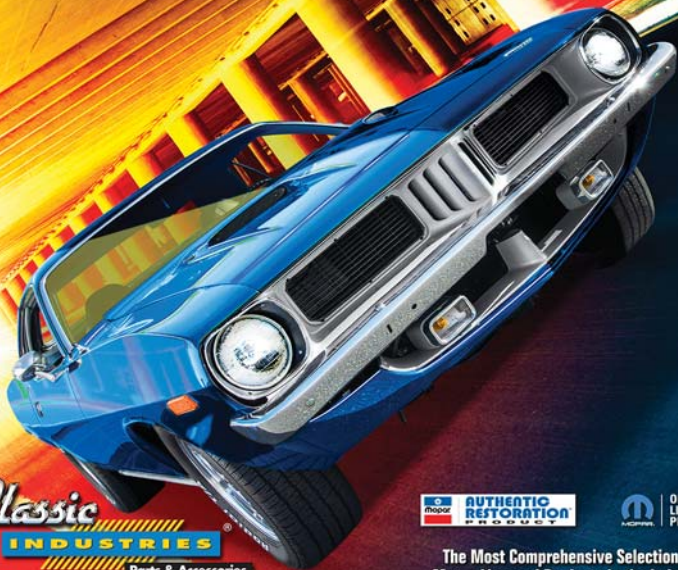

Classic
INDUSTRIES
Parts & Accessories



The Most Comprehensive Selection of
Mopar Licensed Products in the Industry

CALL TOLL-FREE OR
ORDER ONLINE TODAY **1-800-854-1280** | classicindustries.com



New Product Showcase



1970-74 E-Body Windshield Moldings

Reproduction windshield molding set for 1970-74 E-Body models. This official Mopar Authentic Restoration Product features the correct stainless finish and contours for an original appearance and fit.

ME175931 1970-74 5 piece set 269.99 set



1964-71 Chrysler HEMI Edelbrock Dual-Quad Manifold

These Dual-Quad HEMI intake manifolds are intended for use with Gen II (1964-71) 426-572 HEMI engines operating in the 2,500 to 6,500+ range. These new intake manifolds are a single-plane Air-Gap® design with a dual square-bore 4150 style carburetor pad. Carburetor spacing and height are the same as Mopar Performance dual-quad, making it a direct bolt-on for all vehicles with a shaker hood. They also retain the same carburetor linkage location from the factory. The Dual-Quad HEMI manifold is compatible with factory style cylinder heads.

E7524 1964-71 479.99 ea



MW923

Cast Aluminum 17" Magnum 500 Wheel

Seventeen inch cast aluminum version of the Magnum 500 road wheels originally available on Mopar models. Wheels feature black powder coating with machined edges. Accepts original style center caps (sold separately).

Important: Not compatible with factory lug nuts. Use WK94 lug nuts on these wheels.

Note: Shipped overweight.

MW922	17" x 8"	4-1/2" backspacing	239.99 ea
R4437	17" x 8"	set of four - 4-1/2" backspacing	899.99 set
MW923	17" x 8"	5" backspacing	239.99 ea
R4438	17" x 9"	set of four - 5" backspacing	899.99 set
716201	7/16" x 20	chrome acorn nuts (set of 5)	11.99 set



1964 Plymouth B-Body Park Lamp Lenses

Reproduction parking lamp lenses for 1964 Plymouth B-Body models. Manufactured to factory specifications with a special UV protector to prevent fading and cracking. Mounting gaskets are included.

MB280966 1964 69.99 pr



1969-71 Holley Six Pack Carburetors

These reproduction carburetors from Holley are nearly exact duplicates of the ones that came on 1969-71 six pack engines, from the vacuum hook-ups and fuel inlets to the dichromate finish.

Note: Only center carburetors have a choke. No further discounts apply.

Big Block

H4144	1969-70	350 CFM Center Carburetor A/T	629.99 ea
H4670	1971	350 CFM Center Carburetor A/T	539.99 ea
H4365	1969-70	500 CFM Outboard Carburetor A/T M/T	449.99 ea
H4672	1971	500 CFM Outboard Carburetor A/T M/T	421.99 ea

Small Block

H4792	1970-71	350 CFM Center Carburetor A/T	529.99 ea
H4790	1970-71	500 CFM Outboard Carburetor A/T M/T	414.99 ea



MD5801
light argent

MD5802
dark argent

MD5803
light argent

MD5804
dark argent

1970-74 Rallye Wheel Caps

Restorer's Choice Rallye wheel caps are premium-quality caps for the restorers who demand the highest quality and most accurate reproduction parts available. These caps feature the original dark and light argent colors with the correct metallic flake and texture. Each cap includes mounting hardware and stainless center decal.

1970-71 A-Body Rallye Wheel Cap Sets

Rallye wheel caps for 1970-71 A-Body models with the small 5 x 4" bolt pattern wheels. Sold individually.

MD5801	1970	light argent	54.99 ea
MD5802	1971	dark argent	54.99 ea

1970-71 B & E-Body Rallye Wheel Cap Sets

Rallye wheel caps for 1970-71 B & E-Body models with the large 5 x 4-1/2" bolt pattern wheels. Sold individually.

MD5803	1970	light argent	54.99 ea
MD5804	1971	dark argent	54.99 ea

Get The OER® Advantage. . . It's Almost Unfair!

Authentic Quality Reproduction Parts for Classic American Muscle

ORIGINAL QUALITY • ORIGINAL APPEARANCE



Original Fit

Appearance is extremely important in reproduction parts, but just as important is the way the part fits. You will appreciate OER® reproductions. Parts are designed to fit as closely to the original as possible. Each part is checked and rechecked to ensure proper fit and function.

Superior Quality

It's one thing to manufacture a reproduction part, it's another to duplicate the quality. OER® uses the finest quality materials and workmanship to ensure the finished part meets or exceeds original equipment specifications. In fact, many OER® products are superior to the original.

Authentic Appearance

Each OER® part is manufactured to original specifications, down to the smallest detail. Consistent quality control methods ensure an exact duplicate every time.

OER® Officially Licensed Products

Many OER® products are officially licensed by the original manufacturers, assuring the highest quality reproductions available.



MOPAR, DODGE, FORD, PLYMOUTH, and CHRYSLER
VEHICLES, TRUCKS, and TOYS are trademarks of Chrysler Group
LLC used under license. © Chrysler Group LLC 2016.



**OER ORIGINAL
EQUIPMENT
REPRODUCTION**

Manufacturing Authentic Products for The Restoration Industry

Learn more about OER online: www.oerparts.com

Look for the OER® symbol of quality throughout this catalog.

Classic Industries® Has More To Offer!



Discounted Products

Our Everyday Low Pricing Can't Be Beat!

When you see this symbol, it denotes items that have been priced below regular catalog pricing and often, below MSRP. These discounted items, kits, and sets are priced competitively for everyday savings. Because these are pre-discounted, they are exempt from further discounts or promotional offers. Additionally, some products that do not feature this symbol, such as special order items, may also be "discount exempt".



Price Match Guarantee

If You Find a Product for Less, We'll Match the Price!

Classic Industries® will match any competitor's current advertised retail price for an identical product. Simply send us a copy of the competitor's current advertised price from a catalog, advertisement or website (with URL) and we'll match the price. The price match guarantee is available at the time the order is placed and for in-stock merchandise only. Price matching will be determined by a competitor's most current retail-published price and is limited to competitors within the Restoration Industry.



Money Back Guarantee

100% Satisfaction or Your Money Back!

We take pride in the quality of the products we offer and back it up with a 100% Money Back Guarantee. If for any reason you are not satisfied with a product or purchase, you can return the product within 30 days of receipt for a full refund, credit or exchange.



Online Instructional Videos

Visit ClassicIndustries.tv To View Our Online Video Library

Need a little guidance to help you install the restoration parts you purchased? Then cruise over to Classic Industries' new video media website, www.classicindustries.tv where you can watch a library of how-to videos created by our own expert staff, guiding you through the installation processes for upholstery, headliners and more.



Technical Support

Call 1-800-854-1280, extension 5390 for more information

Our tech representatives are ready to help you with all your restoration questions regarding parts or accessories, but we don't stop there, we can help answer questions you may have concerning the detailed areas of your restoration! Our tech representatives consist of some of the most knowledgeable restoration experts in the business. We don't claim to have all the answers but we've been doing it longer than anyone. Chances are we've heard the questions you need answered before. If nothing else, we can probably steer you in the right direction. We continually train our staff in all aspects of early and late model restoration and pass the information along to you!



Earn Rewards!

Great Benefits With Your Classic Industries® Visa® Card

Visit classicindustries.com/creditcard to learn more. The all new Classic Industries® Visa® platinum rewards card is loaded with extras! Earn points at hundreds of online and neighborhood retailers plus bonus points at select merchants*. The best part is you'll receive up to 15% OFF** all orders placed using the Classic Industries® Visa Card.

*Please see Rewards Program Rules for more details.

** NOTE: This discount can not be combined with any other discounts. Some restrictions may apply.

Shop On-Line 24/7

www.classicindustries.com

Visit our website to get information about new products, order a catalog or place an order. Also, watch our helpful How-To videos, builds of Classic Industries® project cars and more. Become a fan on Facebook, check out our videos on YouTube, and follow us on Twitter
Email: info@classicindustries.com



Classic Gift Certificate

Give the ultimate gift to your automotive enthusiast!



A Classic Industries® gift certificate may be used towards the purchase of thousands of parts, literature, accessories or gift items. A gift certificate can be redeemed for any and all products in the catalog of your choice. The purchase of a gift certificate includes 1st class mailing of the most current Classic Industries® catalog of your choice (please specify when ordering). Gift Certificates must be paid in advance. The certificates are redeemable in person, by phone or with your order by mail.

*Available in any denomination.
\$25 minimum.
Contact our sales department to purchase your gift certificates today!*

Give The Ultimate Gift to Your Automotive Enthusiast!



Symbols of Quality

OER® Original Equipment Reproduction

The leader in quality reproductions is here! OER® stands for Original Equipment Reproduction®. When you see the OER® logo, you can be assured that every part is manufactured to exact factory specifications and will fit and function just like the original part. What's more, many OER® products are officially licensed and carry a full one year warranty against defects and workmanship.



MOPAR Authentic Restoration Products

Only products identified with this logo are MOPAR Authentic Restoration Products. Classic Industries® advertises a variety of products with the above MOPAR Authentic Restoration Product logo. This logo indicates that the product is manufactured to MOPAR's specifications and licensed by Chrysler Group LLC as a MOPAR Authentic Restoration Product. Such products represent a prestigious class of restoration parts that are nearly identical to the original products offered by MOPAR in the 1960's and 1970's.

MOPAR, DODGE, HEMI, and PLYMOUTH vehicles, images, and logos are trademarks of Chrysler Group LLC used under license. © Chrysler Group LLC 2012.



MOPAR Official Licensed Product

MOPAR and Chrysler Group, LLC have officially licensed select items identified with this logo. MOPAR is a symbol of quality and performance, and only the best products are fit to carry the name of the brand. When a product is identified with this logo, you can be assured that such products are premier products in the industry.

MOPAR, DODGE, HEMI, and PLYMOUTH vehicles, images, and logos are trademarks of Chrysler Group LLC used under license. © Chrysler Group LLC 2012.



Gold Key is the Symbol of Interior Quality

When you see this symbol of quality, you know you're getting the best the market has to offer. This symbol will denote specialty interior products which are outstanding in fit, craftsmanship and manufacturing techniques. These products have been stringently tested over the course of years and fall into the Gold Key category.



Classic Industries® The Restorers Choice™

Count on the Classic Industries® Restorers Choice symbol whenever purchasing reproduction parts and accessories. You can be sure that each and every product displaying this symbol is manufactured correctly to exact specifications and fits the way the factory intended. This Classic Industries® symbol is your assurance of quality.



Made in USA

Classic Industries is proud to offer American products for your American classic. Wherever you see this MADE IN USA symbol, you know you're receiving the highest quality parts, sourced from the skilled craftsmen of the United States of America.



We Carry Brand Names You Know and Trust...



...and Much More

Table of Contents

A	Interior Components	6-97
	Upholstery, Door Panels, Carpet, Floor Mats, Seat Belts	
B	Dash & Console Components	98-147
	Dash Pads, Steering Wheels, Gauges, Audio, Consoles	
C	Automotive Lifestyle Products	148-167
	Caps, T-shirts, Belts, Keychains, Artwork, Collectibles, Gifts	
D	Literature, CD's & Videos	168-179
	Body Manuals, Shop Manuals, Books, DVDs	
E	Car Care Products	180-197
	Security, Detailing Supplies, Garage/Storage, Paint	
F	Emblems & Decals	198-227
	Interior & Exterior Emblems, Engine Decals, Body Decals	
G	Weatherstrip & Molding	228-247
	Weatherstripping, Grommets, Gaskets, Moldings	
H	Body Components	248-323
	Sheet Metal, Spoilers, Bumpers, Grills, Lamps, Truck	
I	Steering, Suspension, Rear End & Brakes	324-375
	Power Steering, Suspension, Brake Conversions, Wheels, Tires	
J	AC, Heater & Cooling System	376-391
	Heater Cores, Radiators, Hoses, Fan Shrouds, Electric Fans	
K	Engines & Components	392-449
	Engines, Engines Mounts, Valve Covers, Chrome Kits, Timing Covers	
L	Fuel & Exhaust	450-485
	Fuel Caps, Fuel Tanks, Fuel Pumps, Carburetors, Headers	
M	Transmission, Shifters & Clutch	486-503
	Transmission Oil Pans, Flywheels, Shifters, Clutch Components	
N	Batteries & Wiring	504-525
	Electrical Components, Under Dash Wiring, Battery Tools	
O	Index, Policies & Order Forms	526-552
	Policies, General Info, Order Forms, Warranty Info	

The Economical Way to Protect Your Investment!

FREE
Car Wash
with purchase
of a \$249.00 cover



Diamond Blue™

- ★ Indoor Use
- ★ Single Layer Material



Diamond Blue

Protect your Mopar Muscle Car from dust and dirt with OER® Authorized custom fit Diamond Blue™ car covers. Designed for use indoors, the Diamond Blue™ is manufactured using an economical single layer material that provides good protection from dust and dirt penetration. Includes non-scratch grommets installed on each side of the cover to allow the use of a tie-strap and lock.

A-Body

MT3300A	1960-62	Lancer & Valiant	Reg. 99.00	79.99 ea
MT4101A	1963-66	Valiant	Reg. 99.00	79.99 ea
MT3501A	1967-76	all (except Barracuda Fastback)	Reg. 99.00	79.99 ea
MT4104A	1964-66	Barracuda Fastback	Reg. 99.00	79.99 ea
MT4105A	1967-69	Barracuda Fast back	Reg. 99.00	79.99 ea

B-Body

MT4106A	1962-70	all (except Charger)	Reg. 90.00	79.99 ea
MT4110A	1966-67	Charger	Reg. 90.00	79.99 ea
MT4106A	1968-70	Charger	Reg. 90.00	79.99 ea
MT4107A	1971-72	all 2 door	Reg. 90.00	79.99 ea
MT8506A	1971-74	all 4 door	Reg. 90.00	79.99 ea
MT4111A	1973-74	all 2 door	Reg. 90.00	79.99 ea

E-Body

MT4112A	1970-72	Barracuda, 'Cuda	Reg. 90.00	79.99 ea
MT4113A	1973-74	Barracuda, 'Cuda	Reg. 90.00	79.99 ea
MT4114A	1970-72	Challenger	Reg. 90.00	79.99 ea
MT4115A	1973-74	Challenger	Reg. 90.00	79.99 ea

Diamond Fleece™

- ★ Indoor/Outdoor Use
- ★ Triple Layer Material



Diamond Fleece fabric

Designed for indoor and occasional outdoor use, the Diamond Fleece™ is manufactured using 3 layer material which helps prevent dust and dirt penetration and damage from the sun's UV rays. Each cover is sewn with double-stitched seams that are strong and durable. Neoprene elastic is sewn into the front and rear hems to help secure the cover in place. Non-scratch grommets are installed on each cover to allow the use of your tie-strap or lock.

A-Body

MT3300B	1960-62	Lancer & Valiant	Reg. 199.00	129.99 ea
MT4101B	1963-66	Valiant	Reg. 199.00	129.99 ea
MT3501B	1967-76	all (except Barracuda Fastback)	Reg. 199.00	129.99 ea
MT4104B	1964-66	Barracuda Fastback	Reg. 199.00	129.99 ea
MT4105B	1967-69	Barracuda Fastback	Reg. 199.00	129.99 ea

B-Body

MT4106B	1962-70	all (except Charger)	Reg. 199.00	129.99 ea
MT4110B	1966-67	Charger	Reg. 199.00	129.99 ea
MT4106B	1968-70	Charger	Reg. 199.00	129.99 ea
MT4107B	1971-72	all 2 door	Reg. 199.00	129.99 ea
MT8506B	1971-74	all 4 door	Reg. 199.00	129.99 ea
MT4111B	1973-74	all 2 door	Reg. 199.00	129.99 ea

E-Body

MT4112B	1970-72	Barracuda, 'Cuda	Reg. 199.00	129.99 ea
MT4113B	1973-74	Barracuda, 'Cuda	Reg. 199.00	129.99 ea
MT4114B	1970-72	Challenger	Reg. 199.00	129.99 ea
MT4115B	1973-74	Challenger	Reg. 199.00	129.99 ea

- ★ Outdoor Use
- ★ Four Layers of Protection

OER AUTHORIZED

Our exclusive soft cotton lining provides added protection against dings and scratches.

Designed for outdoor use, the Weather Blocker™ cover is manufactured using a durable 4 layer material that provides a high level of protection against outdoor elements. The fourth layer is a soft cotton backing that further protects against scratches and dings. Each cover is sewn with double-stitched seams that are strong and durable. Neoprene elastic is sewn into the front and rear hems to help secure the cover in place. Specify blue, gray or tan.

A-Body

MT3300G	1960-62	Lancer & Valiant	Reg. 179.00	159.99 ea
MT4101G	1963-66	Valiant	Reg. 179.00	159.99 ea
MT3501G	1967-76	all (except Barracuda Fastback)	Reg. 179.00	159.99 ea
MT4104G	1964-66	Barracuda Fastback	Reg. 179.00	159.99 ea
MT4105G	1967-69	Barracuda Fastback	Reg. 179.00	159.99 ea

B-Body

MT4106G	1962-70	all (except Charger)	Reg. 179.00	159.99 ea
MT4110G	1966-67	Charger	Reg. 179.00	159.99 ea
MT4106G	1968-70	Charger	Reg. 179.00	159.99 ea
MT4107G	1971-72	all 2 door	Reg. 179.00	159.99 ea
MT8506G	1971-74	all 4 door	Reg. 179.00	159.99 ea
MT4111G	1973-74	all 2 door	Reg. 179.00	159.99 ea

E-Body

MT4112G	1970-72	Barracuda, 'Cuda	Reg. 179.00	159.99 ea
MT4113G	1973-74	Barracuda, 'Cuda	Reg. 179.00	159.99 ea
MT4114G	1970-72	Challenger	Reg. 179.00	159.99 ea
MT4115G	1973-74	Challenger	Reg. 179.00	159.99 ea

SoftShield™

- ★ Indoor Use
- ★ Cotton Flannel Material

Softshield
cotton flannel fabric

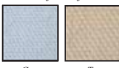

Our woven soft cotton flannel car covers pamper your vehicle's finish with a super-soft underside nap that protects delicate surfaces. Designed for indoor use only, the SoftShield™ is soft on paint, providing a dust barrier and protection against nicks and dings. Each cover is sewn with double-stitched seams that are strong and durable. Neoprene elastic is sewn into the front and rear hems to help secure the cover in place. Your choice of gray or tan flannel.

A-Body

MT3300F	1960-62	Lancer & Valiant	Reg. 299.00	219.99 ea
MT4101F	1963-66	Valiant	Reg. 299.00	219.99 ea
MT3501F	1967-76	all (except Barracuda Fastback)	Reg. 299.00	219.99 ea
MT4104F	1964-66	Barracuda Fastback	Reg. 299.00	219.99 ea
MT4105F	1967-69	Barracuda Fastback	Reg. 299.00	219.99 ea

B-Body

MT4106F	1962-70	all (except Charger)	Reg. 299.00	219.99 ea
MT4110F	1966-67	Charger	Reg. 299.00	219.99 ea
MT4106F	1968-70	Charger	Reg. 299.00	219.99 ea
MT4107F	1971-72	all 2 door	Reg. 299.00	219.99 ea
MT8506F	1971-74	all 4 door	Reg. 299.00	219.99 ea
MT4111F	1973-74	all 2 door	Reg. 299.00	219.99 ea

E-Body

MT4112F	1970-72	Barracuda, 'Cuda	Reg. 299.00	219.99 ea
MT4113F	1973-74	Barracuda, 'Cuda	Reg. 299.00	219.99 ea
MT4114F	1970-72	Challenger	Reg. 299.00	219.99 ea
MT4115F	1973-74	Challenger	Reg. 299.00	219.99 ea

A CUSTOM CAR COVERS

The Ultimate In Outdoor Protection For Your Vehicle



FREE
Weatherstripping
\$5.95



Add a Storage Bag

Protect your car cover with a storage bag designed to fit covers for all years. A storage bag will help to keep your car cover clean and safe when not in use.

CC28..... 9.99 ea



Rain

Air
Technalon delivers the best combination of water-resistant and breathable performance.

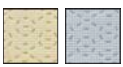

Gold Gray

Technalon Premium Car Covers

A high-tech 4-layer fabric, Technalon is lightweight, remains pliable in all weather conditions and resists rot, odors, and mildew. The outside and inside layers are made of long fibers which make the fabric strong, but very soft and non-abrasive. The middle layer is made of shorter fibers that catch water but allow the air to circulate. Specially developed for harsh outside weather conditions and will not freeze even in the coldest temperatures. Each cover is water-resistant and breathes, keeping your paint free from unwanted moisture between the paint and the car cover which could ruin your paint. Storage bag sold separately. Specify color when ordering.

Dodge A-Body

CV4101	1961-62	Lancer.....	199.99 ea
CV4102	1963-66	Dart.....	199.99 ea
CV4119	1967-72	Dart.....	234.99 ea
CV4102	1969-74	Swinger.....	199.99 ea
CV4101	1971-72	Demon.....	199.99 ea
CV4102	1973-74	Dart.....	199.99 ea
CV3500	1975-76	Swinger.....	199.99 ea

Dodge B-Body

CV4106	1962	Dart.....	239.99 ea
CV4106	1962	Polara.....	239.99 ea
CV8503	1963-64	330, 440.....	244.99 ea
CV8503	1963-64	Polara.....	244.99 ea
CV4118	1965-72	Coronet.....	234.99 ea
CV4110	1966-67	Charger.....	209.99 ea
CV4166	1968-70	Charger, Super Bee.....	234.99 ea
CV4116	1969	Daytona.....	234.99 ea
CV4107	1971-72	Charger, Super Bee.....	239.99 ea
CV4111	1973-74	Charger.....	239.99 ea
CV4117	1975-78	Charger.....	234.99 ea
CV4111	1973-76	Charger.....	239.99 ea

Dodge E-Body

CV4114	1970-72	Challenger.....	199.99 ea
CV4115	1973-74	Challenger.....	199.99 ea

Plymouth A-Body

CV3300	1960-62	Valiant.....	199.99 ea
CV4101	1963-72	Valiant.....	199.99 ea
CV4104	1964-66	Barracuda fastback.....	199.99 ea
CV4105	1967-69	Barracuda fastback.....	199.99 ea
CV4120	1970-76	Duster.....	234.99 ea
CV3500	1971-72	Scamp.....	199.99 ea
CV4102	1973-74	Scamp.....	199.99 ea
CV4102	1973-74	Valiant.....	199.99 ea
CV3500	1975-76	Valiant.....	199.99 ea
CV3500	1975-76	Scamp.....	199.99 ea

Plymouth B-Body

CV4106	1962-64	Fury.....	239.99 ea
CV4106	1963-67	Belvedere.....	239.99 ea
CV4106	1965-70	Satellite.....	239.99 ea
CV4106	1967-70	GTX.....	239.99 ea
CV4118	1968-70	Road Runner.....	234.99 ea
CV4107	1971	GTX.....	239.99 ea
CV4107	1971-72	Road Runner, Satellite 2 door.....	239.99 ea
CV4106	1971-72	Satellite 4 door.....	239.99 ea
CV8506	1973-74	Satellite.....	244.99 ea
CV8506	1973-75	Road Runner.....	244.99 ea

Plymouth E-Body

CV4112	1970-72	Barracuda, 'Cuda.....	199.99 ea
CV4113	1973-74	Barracuda, 'Cuda.....	199.99 ea

DEER AUTHORIZED

Titanium and Titanium Plus car covers are designed for interior or outdoor use, they have a silver, highly reflective water repellent 100% polyester top layer that keeps your interior cool when in sunlight. Each cover is sewn

with double-stitched seams that are strong and durable. Neoprene elastic is sewn into the front and rear hems to help secure the cover in place. With its reflective silver properties, Titanium Plus™ offers the ultimate UV protection. Non-scratch grommets are installed on each cover to allow the use of your tie-strap or lock.



Lightweight highly reflective material for added protection from harmful UV rays



Our exclusive soft cotton lining provides added protection against dings and scratches.

Titanium Car Covers

A-Body			
MT3300K	1960-62	Lancer & Valiant.....	Reg. 179.99 139.99 ea
MT4101K	1963-66	Valiant.....	Reg. 179.99 139.99 ea
MT3501K	1967-76	all (except Barracuda Fastback).....	Reg. 179.99 139.99 ea
MT4104K	1964-66	Barracuda Fastback.....	Reg. 179.99 139.99 ea
MT4105K	1967-69	Barracuda Fastback.....	Reg. 179.99 139.99 ea
B-Body			
MT4106K	1962-70	all (except Charger).....	Reg. 179.99 139.99 ea
MT4110K	1966-67	Charger.....	Reg. 150.00 139.99 ea
MT4106K	1968-70	Charger.....	Reg. 179.99 139.99 ea
MT4107K	1971-72	all 2 door.....	Reg. 179.99 139.99 ea
MT8506K	1971-74	all 4 door.....	Reg. 150.00 139.99 ea
MT4111K	1973-74	all 2 door.....	Reg. 179.99 139.99 ea

E-Body

MT4112K	1970-72	Barracuda, 'Cuda.....	Reg. 150.00 139.99 ea
MT4113K	1973-74	Barracuda, 'Cuda.....	Reg. 150.00 139.99 ea
MT4114K	1970-72	Challenger.....	Reg. 150.00 139.99 ea
MT4115K	1973-74	Challenger.....	Reg. 179.99 139.99 ea

Titanium Plus Car Covers

Titanium Plus™ has a soft padded cotton inner layer that provides extra protection against nicks and dings during storage.

A-Body

MT3300H	1960-62	Lancer & Valiant.....	Reg. 179.99 159.99 ea
MT4101H	1963-66	Valiant.....	Reg. 179.99 159.99 ea
MT3501H	1967-76	all (except Barracuda Fastback).....	Reg. 179.99 159.99 ea
MT4104H	1964-66	Barracuda Fastback.....	Reg. 179.99 159.99 ea
MT4105H	1967-69	Barracuda Fastback.....	Reg. 179.99 159.99 ea

B-Body

MT4106H	1962-70	all (except Charger).....	Reg. 179.99 159.99 ea
MT4110H	1966-67	Charger.....	Reg. 179.99 159.99 ea
MT4106H	1968-70	Charger.....	Reg. 179.99 159.99 ea
MT4107H	1971-72	all 2 door.....	Reg. 179.99 159.99 ea
MT8506H	1971-74	all 4 door.....	Reg. 179.99 159.99 ea
MT4111H	1973-74	all 2 door.....	Reg. 179.99 159.99 ea

E-Body

MT4112H	1970-72	Barracuda, 'Cuda.....	Reg. 179.99 159.99 ea
MT4113H	1973-74	Barracuda, 'Cuda.....	Reg. 179.99 159.99 ea
MT4114H	1970-72	Challenger.....	Reg. 179.99 159.99 ea
MT4115H	1973-74	Challenger.....	Reg. 179.99 159.99 ea

Gust Guard™ Cover Clamps **New!**

The Gust Guard™ is the easy solution for keeping your car cover in place in windy conditions! If you need to leave your vehicle covered for extended periods of time (car show, outdoor storage) in locations where wind gust could be a problem, this kit is the answer. Includes 4 adjustable hem clamps, 2 "Quick Grip" friction locks and 2 - 7' long white cords. These components clamp to the hem in front of the front tires and behind the rear tires. When wind gets under the car cover, the Gust Guard™ helps reduce the possibility of the cover coming loose.



CV7001 11.99 set

OEM Quality Molded Carpet

Treat Your Classic Plymouth or Dodge To The Highest Quality Molded Carpet On The Market!

Manufactured using OEM equivalent materials including color-matched edge binding offering an original appearance.



Absolutely the highest quality molded carpet available! All carpet is pre-formed as original and manufactured using OEM equivalent materials. Each carpet set features a correct heel pad, color-matched surged edges where front carpet overlaps rear carpet, original blend carpet material for your year and model, and includes a dimmer switch grommet. Features jute padding and a pre-cut grommet hole in the carpet for easy grommet installation (when applicable). Heat stamped, pre-formed and trimmed to fit your floor pan perfectly. Made in USA.

The heel pad is manufactured exactly as original. Each set features the correct configuration for each model year in the correct matching color.

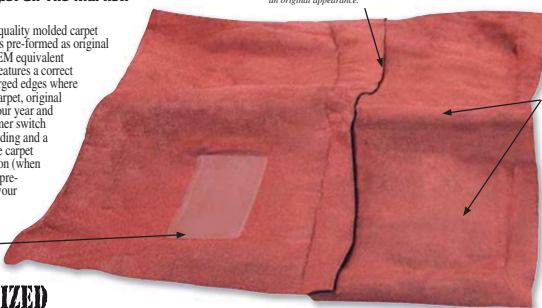

Truly the finest form-fitted carpet available. Each set is molded to original floor pan specifications.

OEM AUTHORIZED

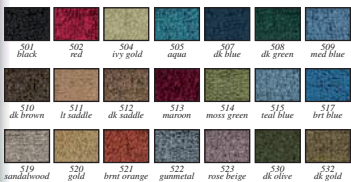
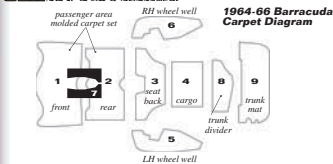

1964-69 Barracuda

When ordering, please refer to diagram above to determine what is included in each set of desired. Select part number of desired set from listings below, then add the color code suffix for your model year Barracuda from the color code chart above. Note: 1967-69 sets do not include the trunk mat.

1964-66 Barracuda			
MA507	1964-66	4-spd. complete set-items 1 thru 9.....	479.99 set
MA508	1964-66	4-spd. passenger area w/console strips.....	249.99 set
MA509	1964-66	4-spd. passenger area w/o console strips.....	159.99 set
MA510	1964-66	AT, complete set-items 1 thru 9.....	479.99 set
MA511	1964-66	AT, passenger area w/console strips.....	199.99 set
MA512	1964-66	AT, passenger area w/o console strips.....	159.99 set
1967-69 Barracuda Fastback			
MA513	1967-69	4-spd. complete set-items 1 thru 6 w/o console strips.....	479.99 set
MA515	1967-69	4-spd. passenger area.....	199.99 set
MA516	1967-69	AT, complete set-items 1 thru 7.....	479.99 set
MA517	1967-69	AT, passenger area w/console strips.....	199.99 set
MA518	1967-69	AT, passenger area w/o console strips.....	159.99 set



1962-73 A-Body Molded Loop Carpet

Molded loop carpet offered in a variety of colors to suit your vehicle. To order, please select the correct application from the listings below, then add the color code suffix for your model year from the color chart. Manufactured in the USA!

1962 Lancer/Valliant		2 door.....	159.99 set
MA500	1962	4 door.....	159.99 set
MA501	1962		159.99 set
1963-66 Dart		2 door 4-speed.....	159.99 set
MA502	1963-66	2 door automatic.....	159.99 set
MA503	1963-66	convertible 4-speed with tails.....	159.99 set
MA504	1963-66	convertible automatic with tails.....	159.99 set
MA505	1963-66	4 door.....	159.99 set
MA506	1963-66		159.99 set
1963-66 Valliant		2 door 4-speed.....	159.99 set
MA519	1963-66	2 door automatic.....	159.99 set
MA520	1963-66	4 door.....	159.99 set
MA521	1963-66	convertible.....	159.99 set
MA522	1963-66		159.99 set
1963-67 Valliant Signet		2 door 4-speed.....	159.99 set
MA523	1963-66	2 door automatic.....	159.99 set
MA524	1963-66	convertible.....	159.99 set
MA525	1963-66	2 door 4-speed.....	159.99 set
MA526	1967	2 door automatic.....	159.99 set
MA527	1967	2 door automatic.....	159.99 set
1967-73 Dart (except 1973 Dart Sport)		2 door 4-speed.....	159.99 set
MA528	1967-73	2 door automatic.....	159.99 set
MA529	1967-73	convertible 4-speed, with tails.....	159.99 set
MA530	1967-73	convertible automatic, with tails.....	159.99 set
MA531	1967-73	4 door.....	159.99 set
MA532	1967-73		159.99 set
1967-73 Valliant		2 door 4-speed.....	159.99 set
MA533	1967-69	2 door automatic.....	159.99 set
MA534	1967-69	4 door.....	159.99 set
MA535	1967-73		159.99 set
1970-73 Duster, 1973 Dart Sport		2 door 4-speed.....	159.99 set
MA536	1970-73	2 door automatic.....	159.99 set
MA537	1970-73		159.99 set
1971-73 Scamp		2 door 4-speed.....	159.99 set
MA540	1971-73	2 door automatic.....	159.99 set
MA541	1971-73		159.99 set
1971-72 Demon		2 door 4-speed.....	159.99 set
MA538	1971-72	2 door automatic.....	159.99 set
MA539	1971-72		159.99 set

A INTERIOR COMPONENTS

1966 Charger Carpet Diagram

01. Door Panel Left
02. Floor-Pan (2 pc.)
03. Door Panel Right
04. Front Console Left
05. Front Console Right
06. Front Console Left
07. Front Console Right
08. Seatabuck Left
09. Seatabuck Right
10. Rear Console Left
11. Rear Console Right
12. Quarter Trim Left
13. Quarter Trim Right
14. Rear Seatabuck Left
15. Fold Down Armrest
16. Rear Seatabuck Right
17. Wheel Well Left
18. Cargo Floor
19. Wheel Well Right
20. Trunk Divider Door

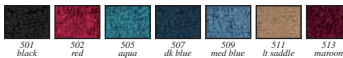
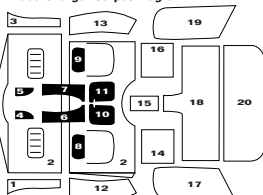

1966-67 Charger

When ordering, please refer to diagram to determine what is included in each of the sets offered. Select part number of desired set from listings, then add the color code suffix for your model year Charger from the color code chart above. Made in USA.
 Note: Trunk mat sold separately.

1966-67 Charger

MB935 1966	4-speed, complete set - items 1-20	519.99 set
MB936 1966	4-speed, passenger area w/console strips	254.99 set
MB937 1966	4-speed, passenger area w/o console strips	179.99 set
MB938 1966	automatic, complete set - items 1-20	489.99 set
MB939 1966	automatic, passenger area w/console strips	249.99 set
MB940 1966	automatic, passenger area w/o console strips	179.99 set
MB941 1967	4-speed, complete set - items 1-20	519.99 set
MB943 1967	4-speed, passenger area w/console strips	254.99 set
MB942 1967	4-speed, passenger area w/o console strips	159.99 set
MB944 1967	automatic, complete set - items 1-20	469.99 set
MB945 1967	automatic, passenger area w/console strips	249.99 set
MB946 1967	automatic, passenger area w/o console strips	179.99 set

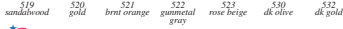
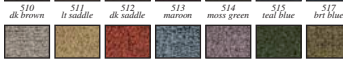

1962-73 B-Body Molded Loop Carpet

Molded loop carpet offered in a variety of colors to suit your vehicle. To order, please select the correct application from the listings below, then add the color code suffix for your model year from the color chart above. Made in USA.

1962 Dart, Dart 330, Dart 440, Polara 500

MB902 1962	2 door 4-speed	159.99 set
MB903 1962	2 door automatic	159.99 set
MB904 1962	4 door 4-speed	159.99 set
MB905 1962	4 door automatic	159.99 set

1962-65 Belvedere

MB906 1962-65	2 door 4-speed	159.99 set
MB907 1962-65	2 door automatic	159.99 set
MB908 1962-65	4 door 4-speed	159.99 set
MB909 1962-65	4 door automatic	159.99 set

1962-64 Fury

MB910 1962-64	2 door 4-speed	159.99 set
MB911 1962-64	2 door automatic	159.99 set
MB912 1962-64	4 door automatic	159.99 set

1963 Sport Fury

MB913 1963	2 door	159.99 set
------------	--------	------------

1963-64 Dodge 330, 440, Polara, Polara 500

MB914 1963-64	2 door 4-speed	159.99 set
MB915 1963-64	2 door automatic	159.99 set
MB916 1963-64	4 door automatic	159.99 set

1965 Coronet

MB917 1965	2 door 4-speed	159.99 set
MB918 1965	2 door automatic	159.99 set
MB919 1965	4 door automatic	159.99 set

1965 Satellite

MB920 1965	2 door 4-speed	159.99 set
MB921 1965	2 door automatic	159.99 set
MB922 1965	4 door automatic	159.99 set

1966 Belvedere

MB923 1966	2 door 4-speed	159.99 set
MB924 1966	2 door automatic	159.99 set
MB925 1966	4 door 4-speed	159.99 set
MB926 1966	4 door automatic	159.99 set

1967-70 Belvedere

MB923 1967-70	2 door 4-speed	159.99 set
MB928 1967-70	2 door automatic	159.99 set
MB925 1967-70	4 door 4-speed	159.99 set
MB926 1967-70	4 door automatic	159.99 set

1966-70 Coronet

MB931 1966-70	2 door 4-speed	159.99 set
MB932 1966-70	2 door automatic	159.99 set
MB933 1966-70	4 door 4-speed	159.99 set
MB934 1966-70	4 door automatic	159.99 set

1966-70 Satellite

MB947 1966-70	2 door 4-speed	159.99 set
MB948 1966-70	2 door automatic	159.99 set
MB949 1968-70	4 door automatic	159.99 set

1967-71 GTX

MB950 1967	2 door 4-speed	159.99 set
MB951 1967	2 door automatic	159.99 set
MB952 1968-70	2 door 4-speed	159.99 set
MB951 1968-70	2 door automatic	159.99 set
MB954 1971	2 door, 4-speed, bench seat	159.99 set
MB955 1971	2 door, 4-speed, bucket seats	159.99 set
MB956 1971	2 door, automatic	159.99 set

1968-70 Charger

MB957 1968-70	4-speed	159.99 set
MB958 1968-70	automatic	159.99 set

1971-73 Charger

MB959 1971-73	4-speed	159.99 set
MB960 1971-73	automatic	159.99 set

1968-73 Road Runner

MB961 1968-70	4-speed	159.99 set
MB962 1968-70	automatic	159.99 set
MB963 1971-73	4-speed bench seat	159.99 set
MB964 1971-73	4-speed bucket seats w/console	159.99 set
MB965 1971-73	automatic	159.99 set

1968-71 Super Bee

MB966 1968-70	4-speed	159.99 set
MB967 1968-70	automatic	159.99 set
MB968 1971	4-speed	159.99 set
MB969 1971	automatic	159.99 set

1969 Daytona

MB970 1969	4-speed	159.99 set
MB971 1969	automatic	159.99 set

1971-73 Coronet

MB972 1971-73	4 door automatic	159.99 set
---------------	------------------	------------

1971-73 Satellite

MB973 1971-73	2 door 4-speed bench seat	159.99 set
MB974 1971-73	2 door 4-speed buckets seats w/console	159.99 set
MB975 1971-73	2 door automatic	159.99 set
MB976 1971-73	4 door automatic	159.99 set

1970 Superbird

MB977 1970	4-speed	159.99 set
MB978 1970	automatic	159.99 set

1970-73 E-Body Molded Loop Carpet



Molded loop carpet is offered in a variety of colors to suit your vehicle. To order, please select the correct application from the listings below, then add the color code for your model year from the color chart. Made in USA.

1970-73 Barracuda

ME600 1970-73	manual	159.99 set
ME601 1970-73	automatic	159.99 set

1970-73 'Cuda

ME602 1970-73	manual	159.99 set
ME603 1970-73	automatic	159.99 set

1970-73 Challenger

ME604 1970-73	manual	159.99 set
ME605 1970-73	automatic	159.99 set

Molded Carpet

Every heel pad is manufactured exactly as original. Each set features the correct configuration for each model year and in the correct color.

Truly the finest form-fitted carpet available. Each set is molded using original floor pan specifications.

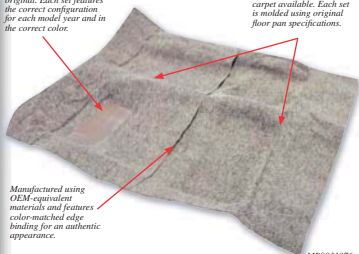

Manufactured using OEM-equivalent materials and features color-matched edge binding for an authentic appearance.

MB98S1076

DEF AUTHORIZED

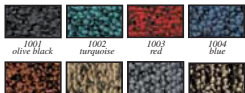

1001 olive black 1002 turquoise 1003 red 1004 blue
1006 copper 1007 gold 1008 med. gray 1076 brown



Made in USA

1963-64 B-Body Texedo Loop Carpet

Molded Texedo loop carpet offered in a variety of colors to suit your vehicle. To order, please select the correct application from the listings below, then add the color code for your model year from the color chart above. Made in USA.

1963-64 Dodge 330, 440, Polara, Polara 500

MB979	1963-64	2 door 4-speed	249.99 set
MB980	1963-64	2 door automatic	249.99 set
MB981	1963-64	4 door automatic	249.99 set

1963-64 Belvedere

MB982	1963-64	2 door 4-speed	249.99 set
MB983	1963-64	2 door automatic	249.99 set
MB984	1963-64	4 door automatic	249.99 set

1963-64 Fury

MB985	1963-64	2 door 4-speed	249.99 set
MB986	1963-64	2 door automatic	249.99 set
MB987	1963-64	4 door automatic	249.99 set

1963 Sport Fury

MB989	1963	2 door	249.99 set
-------	------	--------	------------

DEF AUTHORIZED



801 black 818 ocean blue 825 maroon 859 lt jade 757 gold



Made in USA

1974-76 A-Body Cut Pile Carpet

Molded cut pile carpet offered in a variety of colors to suit your vehicle. To order, please select the correct application from the listings below, then add the correct color code for your model year from the color chart above. Made in USA.

1974-76 Dart Swinger 2 Door Hardtop

MA542	1974-76	2 door hardtop, 4-speed	159.99 set
MA543	1974-76	2 door hardtop, automatic	159.99 set

1974-76 Dart 4 Door Sedan

MA544	1974-76	4 door sedan	159.99 set
-------	---------	--------------	------------

1974-76 Dart Sport, Duster 2 Door Coupe

MA545	1974-76	2 door coupe, 4-speed	159.99 set
-------	---------	-----------------------	------------

MA546	1974-76	2 door coupe, automatic	159.99 set
-------	---------	-------------------------	------------

1974-76 Valiant Sedan

MA547	1974-75	2 door sedan	159.99 set
-------	---------	--------------	------------

MA548	1974-76	4 door sedan	159.99 set
-------	---------	--------------	------------

DEF AUTHORIZED

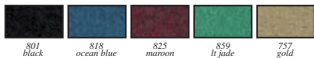

801 black 818 ocean blue 825 maroon 859 lt jade 757 gold



Made in USA

1974-75 B-Body Cut Pile Carpet

Molded cut pile carpet offered in a variety of colors to suit your vehicle. To order, please select the correct application from the listings below, then add the correct color code for your model year from the color chart above. Made in USA.

1974 Charger

MB990	1974	4-speed	159.99 set
MB991	1974	automatic	159.99 set

1974-75 Road Runner

MB992	1974-75	2 door 4-speed bench seat	159.99 set
MB993	1974-75	2 door 4-speed bucket seats w/console	159.99 set
MB994	1974-75	2 door automatic	159.99 set

1974 Satellite

MB995	1974	2 door 4-speed bench seat	159.99 set
MB996	1974	2 door 4-speed buckets seats w/console	159.99 set
MB997	1974	2 door automatic	159.99 set
MB998	1974	4 door automatic	159.99 set

DEF AUTHORIZED

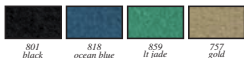

801 black 818 ocean blue 859 lt jade 757 gold



Made in USA

1974 E-Body Cut Pile Carpet

Molded cut pile carpet offered in a variety of colors to suit your vehicle. To order, please select the correct application from the listings below, then add the color code for your model year from the color chart above. Made in USA.

1974 Barracuda

ME606	1974	manual	159.99 set
ME607	1974	automatic	159.99 set

1974 Cuda

ME608	1974	manual	159.99 set
ME609	1974	automatic	159.99 set

1974 Challenger

ME610	1974	manual	159.99 set
ME611	1974	automatic	159.99 set

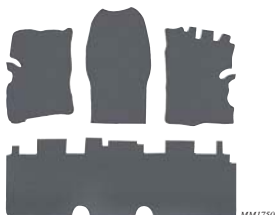

MM1750



Made in USA

1966-76 A/B & E-Body EVA Sound Deadener

This high quality, die-cut EVA sound deadener will insulate your interior from road noise and extreme exterior temperatures. Designed to perfectly fit each model and is easily installed when replacing your old carpet.

MM1750	1967-76	Dart/Valiant	69.99 set
MM1751	1970-76	Demon/Dart Sport/Duster	69.99 set
MM1752	1967-74	Barracuda	69.99 set
MM1753	1970-74	Challenger	69.99 set
MM1754	1966-74	Charger	69.99 set
MM1750	1966-74	Coronet/Super Bee	69.99 set
MM1756	1966-74	GTX/Road Runner/Belvedere/Satellite	69.99 set

Sill Plates/Interior Trim

New!

AUTHENTIC REPRODUCTION



MP14007



MP14011



MA2148



MB2259



MB2260



MB2261



ME1576

1960-74 Door Sill Plates

Reproduction door sill plates for various 1966-74 A, B, and E-Body models. Sill plates are manufactured to OE specifications and feature an authentic original finish.

Note: *Not cosmetically correct for 1960-62 Lancer/Valetian but will fit and function.

A-Body

MP14007* 1960-66 all, two required per vehicle - outer sill plate. 74.99 ea
MP14008 1963-66 2 door (exc Barracuda), LH - inner sill plate. 129.99 ea
MP14009 1963-66 2 door (exc Barracuda), RH - inner sill plate. 129.99 ea
MA2148 1967-74 2 door models 78.99 pr

B-Body

MP14010 1962-65 2 door models (exc conv), 4 piece set 399.99 set
MP14011 1962-65 convertible models, 4 piece set 399.99 set
MP14012 1962-65 outer sill plates only 149.99 pr
MB2259 1966-67 2 door models 78.99 pr
MB2260 1968-70 2 door models 99.99 pr
MB2261 1971-74 2 door models 104.99 pr

E-Body

ME1576 1970-74 all models, OER® 89.99 pr



MA147100 detail



MA147100

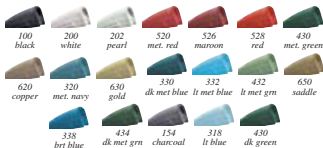

1966-69 2-Door Sedan Windlace

Exact replacement door jamb windlace for 1966-69 A-body and B-Body 2-door sedan models, including Dart, Barracuda, Valiant, Coronet, Belvedere, and Satellite models. Color keyed to match your interior, includes enough windlace for two doors jamba.

A-Body

MA147100	1967-69	black.....	69.99 pr
MA147200	1969	white.....	69.99 pr
MA147202	1967-69	pearl white.....	69.99 pr
MA147520	1967-68	metallic red.....	69.99 pr
MA147526	1968	metallic maroon.....	69.99 pr
MA147528	1968-69	red.....	69.99 pr
MA147430	1967-68	metallic green.....	69.99 pr
MA147430	1967-68	copper.....	69.99 pr
MA147320	1967-68	metallic navy.....	69.99 pr
MA147630	1967-69	gold.....	69.99 pr
MA147330	1968-69	dark metallic blue.....	69.99 pr
MA147332	1968-69	light metallic blue.....	69.99 pr
MA147432	1968-69	light metallic green.....	69.99 pr
MA147650	1969	saddle.....	69.99 pr
MA147338	1969	bright blue.....	69.99 pr
MA147434	1969	dark metallic green.....	69.99 pr
MA147154	1969	charcoal.....	69.99 pr

B-Body

MB193100	1966-67	black.....	109.99 pr
MB193202	1966-67	white.....	109.99 pr
MB193318	1966-67	light blue.....	109.99 pr
MB193320	1966-67	navy.....	109.99 pr
MB193430	1966-67	dark green.....	109.99 pr
MB193520	1966-67	red.....	109.99 pr
MB193630	1966-67	gold.....	109.99 pr

Universal Snap On Windlace by the Foot

Reproduction-style snap on flexible trim, double lip style windlace. Often used to seal interior rear door jamb edges to sill plates and much more. Featuring authentic vinyl grain texture, positive gripping power and rapid application, this flexible vinyl trim is ideal for classic car applications. Available in a variety of colors. Sold by the foot.



Installation detail



WL208 detail



WL200	black.....	2.99 ft	WL207	moss green.....	2.99 ft
WL201	bright red.....	2.99 ft	WL208	tan.....	2.99 ft
WL202	dark red.....	2.99 ft	WL209	silver.....	2.99 ft
WL203	bright blue.....	2.99 ft	WL210	dark saddle.....	2.99 ft
WL204	gold/fawn.....	2.99 ft	WL211	dark brown.....	2.99 ft
WL205	aqua/turquoise.....	2.99 ft	WL212	parch/off white.....	2.99 ft
WL206	dark blue.....	2.99 ft	WL213	bright white.....	2.99 ft

New!



1966-76 Firewall Insulation Fasteners

Reproduction firewall insulation fasteners for all 1966-76 A, B, & E-Body models. Manufactured to original factory specifications, and materials. Officially licensed Mopar Authentic Restoration Product.

Note: *Installed on cars built after September 1972.

Plastic - 11/16" Head x 1-1/2" Long	
MD2148 1962-65 each.....	1.99 ea
MD2149 1962-65 10 pieces.....	17.99 set
Plastic - 11/16" Head x 1-13/16" Long	
MD2125 1966-76 each.....	1.99 ea
MD2731 1966-76 10 pieces.....	17.99 set
Rubber - 3/4" Head x 1-1/4" Long	
MD2103* 1973-74 each.....	2.49 ea
MD2147* 1973-74 10 pieces.....	21.99 set



Quiet Ride Firewall & Seat Shelf Insulators

Your firewall insulation is the first line of defense against engine noise and heat; don't rely on lightweight OE insulation to keep your car comfortable and quiet. Quiet Ride Firewall & Seat Shelf Insulators are molded from thick, premium quality rubber, then fitted with additional sound and thermal insulation for unequalled noise and heat neutralizing. Insulators are year, make and model-specific so each insulator is sure to fit like a glove.

Firewall Insulation

A-Body	
MF701 1962 Valiant.....	149.99 ea
MF702 1963-66 all.....	149.99 ea
MF704 1967-70 all.....	149.99 ea
MF705 1971-76 all.....	149.99 ea
B-Body	
MF706 1965-67 Fury.....	149.99 ea
MF707 1968-70 all.....	132.99 ea
E-Body	
MF708 1970-74 all.....	149.99 ea

Seat Shelf Insulation

A-Body	
MF709 1967-70 all.....	132.99 ea



1962-74 Firewall Insulation Pads

High quality replacement firewall insulation pad that includes clips for installation.

A-Body	
MA1590 1962 Valiant.....	56.99 set
MA1591 1963-66 Dart/Valiant w/o air.....	34.99 set
MA1592 1963-66 Dart/Valiant w/air.....	44.99 set
MA1595 1967-76 all w/o air.....	34.99 set
MA1596 1967-76 all w/air.....	34.99 set
B-Body	
MB1460 1963-65 Fury/Belvedere.....	34.99 set
MB1462 1966-67 all w/o air.....	34.99 set
MB1464 1968-70 all w/air.....	34.99 set
MB1465 1968-70 all w/o air.....	34.99 set
MB1466 1971-74 all w/o air.....	34.99 set
MB1467 1971-74 all w/air.....	34.99 set
E-Body	
ME1330 1970-74 all w/o air.....	34.99 set
ME1331 1970-74 all w/air.....	34.99 set

Insulation

Turn Your Car into a "Quiet Ride Comfort Zone"

This two-stage automotive insulation and sound damping system gives older cars the "quiet ride comfort" found in today's new cars. AcoustiShield sets are designed with current "state-of-the-art" automotive acoustic technology to control noise, vibration and heat in the passenger cabin. Sets include pre-sized Dynamat® damper pads, pre-trimmed heat shield/barrier panels, spray adhesive, sealing tape and fully illustrated instructions for a painless two-hour installation.

Note: Shipped ground only.

AcoustiSHIELD®

Roof to Road Solutions to Control Automotive Noise, Vibration and Heat

Stage 1 Dynamat® Damper Pads



Stage 2 Heat Shield/Barrier Panels



Complete AcoustiShield Sets

A-Body	
MS160 1967-70 coupe.....	761.99 set
MS161 1967-70 convertible.....	627.99 set
MS102 1967-70 sedan.....	807.99 set
MS103 1971-76 coupe.....	802.99 set
MS104 1971-76 sedan.....	849.99 set
B-Body	
MS105 1968-70 coupe.....	761.99 set
MS106 1968-70 convertible.....	627.99 set
MS107 1968-70 sedan.....	807.99 set
E-Body	
MS108 1970-74 coupe.....	761.99 set
MS109 1970-74 convertible.....	627.99 set

MS128 1967-70 convertible.....	142.99 set
MS130 1967-70 sedan.....	142.99 set
MS131 1971-76 coupe.....	142.99 set
MS132 1971-76 sedan.....	142.99 set
B-Body	
MS133 1968-70 coupe.....	142.99 set
MS134 1968-70 convertible.....	142.99 set
MS135 1968-70 sedan.....	142.99 set
E-Body	
MS137 1970-74 coupe.....	142.99 set
MS138 1970-74 convertible.....	142.99 set

Cowl Set

A-Body	
MS140 1967-70 coupe.....	56.99 set
MS141 1967-70 convertible.....	56.99 set
MS142 1967-70 sedan.....	56.99 set
MS143 1971-76 coupe.....	99.99 set
MS144 1971-76 sedan.....	99.99 set
B-Body	
MS145 1968-70 coupe.....	56.99 set
MS146 1968-70 convertible.....	56.99 set
MS147 1968-70 sedan.....	56.99 set
E-Body	
MS148 1970-74 coupe.....	56.99 set
MS149 1970-74 convertible.....	56.99 set

Body Panel Set

A-Body	
MS150 1967-70 coupe.....	142.99 set
MS151 1967-70 convertible.....	142.99 set
MS152 1967-70 sedan.....	127.99 set
MS153 1971-76 coupe.....	142.99 set
MS154 1971-76 sedan.....	127.99 set
B-Body	
MS155 1968-70 coupe.....	142.99 set
MS156 1968-70 convertible.....	142.99 set
MS157 1968-70 sedan.....	127.99 set
E-Body	
MS158 1970-74 coupe.....	142.99 set
MS159 1970-74 convertible.....	142.99 set

Door Damper Set

AS130 1967-76 all - coupe, conv.....	51.99 set
--------------------------------------	-----------

Individual AcoustiShield Sets

Floor Insulation Set

A-Body	
MS112 1967-70 coupe.....	255.99 set
MS111 1967-70 convertible.....	255.99 set
MS112 1967-70 sedan.....	255.99 set
MS113 1971-76 coupe.....	255.99 set
MS114 1971-76 sedan.....	255.99 set
B-Body	
MS115 1968-70 coupe.....	255.99 set
MS116 1968-70 convertible.....	255.99 set
MS117 1968-70 sedan.....	255.99 set
E-Body	
MS118 1970-74 coupe.....	255.99 set
MS119 1970-74 convertible.....	255.99 set

Roof Insulation Set

A-Body	
MS120 1967-70 coupe.....	142.99 set
MS121 1967-70 sedan.....	142.99 set
MS122 1971-76 coupe.....	142.99 set
MS123 1971-76 sedan.....	142.99 set
B-Body	
MS124 1968-70 coupe.....	142.99 set
MS125 1968-70 sedan.....	142.99 set
E-Body	
MS126 1970-74 coupe.....	142.99 set

Trunk Insulation Set

A-Body	
MS127 1967-70 coupe.....	142.99 set

Interior Insulation



HushMat



- #1 Rated Automotive Thermal & Sound Insulator
- Reduces Firewall/Tunnel Heat by Over 40%
- Blocks Exhaust Drone From Entering Interior
- Hushmat Ultra Bonds To Every Surface

- Creates A 10 Db Barrier To Road & Engine Noise
- Performs In Temperatures Up To 550° F
- One Step Peel and Stick Application
- Flexible In All Climates — Molds &Contours Easily

HushMat Ultra Insulation

Starter Set

Four 12" x 12" sheets available in either black or silver. 4.1 square feet (1.25 square meters). A starter set is perfect for single panel treatment or small jobs.

HM250 silver..... 34.99 set
HM251 black..... 34.99 set

Door Set

Ten 12" x 12" sheets available in either black or silver. 10.1 square feet (3.1 square meters). A door set is designed to effectively treat two doors. Treat the inside of the outer door skin, door frame and back of the door trim panel. Replace that cheap metal, rattling noise with a solid sound when you close your doors.

HM200 silver..... 99.99 set
HM201 black..... 99.99 set

Trunk Set

Ten 12" x 23" sheets available in either black or silver. 19.1 square feet (5.8 square meters). A trunk set is designed to effectively treat the trunk floor, spare tire well, quarter panels and rear deck of a vehicle. Helps reduce interior noise typically caused by performance exhaust systems.

HM300 silver..... 144.99 set
HM301 black..... 144.99 set

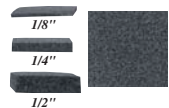

HushMat Sound Absorbing Foam

1/8" Foam

Includes two 23" x 36" sheets of 1/8" Hushmat Silencer Megabond foam. Great for glove boxes, kick panels, or pillar trim to eliminate squeaks and rattles.

HMF01 1/8"..... 119.99 set

1/4" Foam

Includes two 23" x 36" sheets of 1/4" Hushmat Silencer Megabond foam. Apply directly on backs of door panels, headliners or under package trays.

HMF02 1/4"..... 171.99 set

1/2" Foam

Includes four 12" x 23" sheets of 1/2" Hushmat Silencer Megabond foam. Great for firewall, transmission tunnel, floor, and trunk applications. Makes an excellent replacement for traditional jute.

HMF03 1/2"..... 154.99 set

- Absorbs High Frequency Airborne Noise
- Lightweight Synthetic Rubber Foam
- Soft, Flexible, and Highly Compressible
- Moisture Repellent
- Thermal Insulation Up To 300° F
- Aggressive Adhesion
- One Step Peel And Stick Application

Under Carpet Heat Shield & Sound Deadener

Made from fire resistant and sound absorbent fibers, then covered with heat reflective foil, these add a great deal of comfort to your car's interior. Each sound deadener sheet is 4' x 6' and can easily be cut to fit with household scissors.

CMD1003 4' x 6'..... 29.99 ea

Cool It Mat

The Cool-It Mat™ is composed of resin-bonded silica blanketing insulation sandwiched between a mylar facing on one side and a foil facing on the other. The highly-reflective mylar deflects heat away from surfaces, while the foil side faces away from the heat source to conduct any penetrating heat across its surface, thus providing the ultimate in heat protection. The silica blanketing is a dual-density composite and is the main sound insulator. It is easy to trim and can be applied with the provided push-in fasteners or with Thermo-Tec's Heavy-Duty Spray Adhesive.

Insulating Mat
TT1005 24" x 48"..... 31.99 ea
TT1006 48" x 48"..... 64.99 ea
Spray Adhesive
TT12005..... 16.99 ea

Thermo-Guard FR

This lightweight, durable shield does everything. It reduces sound, absorbs vibration, protects from radiant TT1005 heat and provides an extra layer of insulated padding. The product features 100% polyester fiber felt that provides sound and comfort control and a high-tech foil heat barrier that blocks more than 90% of radiant heat. Designed to be applied with Thermo-Tec's Heavy-Duty Spray Adhesive.

One-Side Foil
TT1055 24" x 48"..... 19.99 ea
TT1056 48" x 72"..... 49.99 ea
Two-Side Foil
TT1057 48" x 72"..... 61.99 ea
Spray Adhesive
TT12005..... 16.99 ea



- Soft, Plyable Foam Tape
- For Securing Wires & Cables
- Plus Hundreds of Other Uses
- One Step Peel & Stick Application

Multi-Purpose Quiet Tape

HushMat Quiet Tape is designed to prevent nuisance rattles by securing loose wires and cables. Strong adhesive adheres to virtually any surface!

QT01 1" x 20' roll..... 29.99 set

Custom Cut Insulation Kits

Each kit has been designed specifically for the vehicle application and contains CNC



precision cut sections of self-adhesive Dynamat material in the proper shapes, dimensions, and amounts to fit your vehicle exactly. Custom cut kits feature Dynamat Xtreme material with patented elastomeric VECTOR Chemistry from great sound deadening. With a .060" butyl layer and a .004" thick aluminum face.

- 1967-69 Barracuda, Dart & Valiant
DM232 door..... 199.99 set
DM233 floor..... 399.99 set
DM234 package tray..... 59.99 set
DM235 roof..... 109.99 set
DM236 trunk floor..... 159.99 set
DM237 under rr seat flr..... 199.99 set
- 1970-72 Dart & Valiant
DM232 door..... 199.99 set
DM233 floor..... 399.99 set
DM234 package tray..... 59.99 set
DM237 under rr seat flr..... 199.99 set
- 1970-74 Dart & Valiant
DM236 trunk floor..... 159.99 set
- 1970-76 Dart & Valiant
DM233 floor..... 399.99 set
DM235 roof..... 109.99 set
- 1966-70 Charger & Road Runner
DM239 floor..... 399.99 set
DM241 roof..... 199.99 set
DM242 trunk floor..... 159.99 set
- 1968-70 Charger & Road Runner
DM238 door..... 199.99 set
DM240 package tray..... 69.99 set
DM243 under rr seat flr..... 199.99 set
- 1970-74 Challenger, Barracuda & 'Cuda
DM244 door..... 199.99 set
DM245 floor..... 349.99 set
DM246 package tray..... 59.99 set
DM247 roof..... 109.99 set
DM248 trunk floor..... 109.99 set
DM249 under rr seat flr..... 199.99 set

New!



Dynamat Xtreme Bulk Pack

Our new unique chemistry uses a space age self-adhesive synthetic rubber with a heavy 4 mil aluminum constraining layer to absorb noise energy. At only 1/16" thick, the super sticky rubber and foil stretches and contours to fit your vehicle like a glove. Xtreme Bulk Pack can be also used for trunk lids, roof, quarter panels and under the hood. Xtreme Pack contains 9 sheets (18" x 32") or 36 square feet of 1/16" insulation. DynaTape is 1-1/2" x 30'. Made in USA.

DM261 bulk pack..... 199.99 ea
Installation Accessories
DM262 Dynaroller..... 8.99 ea
DM260 Dynatape..... 8.99 ea

Embroidered Logo Mats



Dodge Logos for Loop Mats



Dart logo

Demon logo

GTS logo



Swinger logo

Charger logo

Charger RT logo



Coronet logo

Super Bee logo

Coronet RT logo



Challenger script

Challenger TA logo

Challenger RT logo

Loop Floor Mat Colors

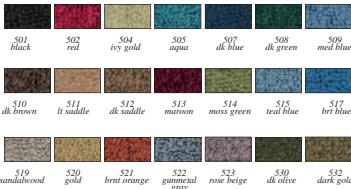

501 black 502 red 504 ivy gold 505 aqua 507 dk blue 508 dk green 509 med blue
510 dk brown 511 lt saddle 512 dk saddle 513 maroon 514 moss green 515 teal blue 517 bri blue
519 sandalwood 520 gold 521 bri orange 522 gummatal gray 523 rose beige 530 dk olive 532 dark gold

Embroidery Colors

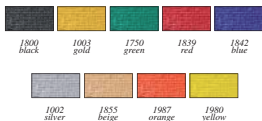

1800 black 1003 gold 1750 green 1839 red 1842 blue
1002 silver 1855 beige 1987 orange 1980 yellow



OFFICIAL LICENSED PRODUCT

1963-73 Dodge Logo Loop Floor Mats

Add the finishing touch to your interior with a set of officially licensed embroidered loop floor mats. Features an embroidered logo on the same carpet material used for our molded carpet sets for a perfect match, color-keyed bound edges and a heavyweight gripper backing for firm traction. Each set includes 2 front and 2 rear mats. Please specify carpet color and embroidery color when ordering.

Made in USA!

Note: Special order, must be pre-paid.

Dodge A-Body

Dart Logo	1963-73	Dart	all transmissions	119.99 set
MA2110	1963-73	Dart	all transmissions	119.99 set
Demon Logo				
MA2114	1971-72	Demon	all transmissions	139.99 set
GTS Logo				
MA2112	1967-69	Dart	all transmissions	119.99 set
Swinger Logo				
MA2113	1969-73	Dart	all transmissions	119.99 set

Dodge B-Body

Charger Logo		Charger	automatic	119.99 set
MB1644	1966-70	Charger	automatic	119.99 set
MB1645	1966-70	Charger	4-speed	119.99 set
MB1646	1971-73	Charger	all transmissions	119.99 set
Charger RT Logo				
MB1647	1968-70	Charger	automatic	119.99 set
MB1648	1968-70	Charger	4-speed	119.99 set
MB1649	1971	Charger	all transmissions	119.99 set
Coronet Logo				
MB1650	1965	Coronet	automatic	119.99 set
MB1651	1965	Coronet	4-speed	119.99 set
MB1652	1966-70	Coronet	automatic	119.99 set
MB1653	1966-70	Coronet	4-speed	119.99 set
MB1654	1971-73	Coronet	all transmissions	119.99 set
RT Logo				
MB1655	1968-70	Coronet	automatic	119.99 set
MB1656	1968-70	Coronet	4-speed	119.99 set
Super Bee Logo				
MB1664	1968-71	Super Bee	automatic	119.99 set
MB1665	1968-71	Super Bee	4-speed	119.99 set

Dodge E-Body

Challenger Script Logo		Challenger	all transmissions	119.99 set
ME684	1970-73	Challenger	all transmissions	119.99 set
Challenger TA Logo				
ME685	1970	Challenger	all transmissions	119.99 set
Challenger RT Logo				
ME686	1970-72	Challenger	all transmissions	119.99 set

A INTERIOR COMPONENTS

Embroidered Logo Mats

Dodge Logos for Cut Pile Floor Mats



Dart logo Swinger logo Challenger script Charger logo

Plymouth Logos for Cut Pile Floor Mats



Satellite logo Valiant script Duster logo



Barracuda script 'Cuda logo 'Cuda on Wheels

Plymouth Logos for Loop Mats



OFFICIAL LICENSED PRODUCT

'Cuda on Wheels

1962-73 Plymouth Loop Floor Mats

Add the finishing touch to your interior with a set of officially licensed embroidered logo floor mats. Features an embroidered logo on the same carpet material used for our molded carpet sets for a perfect match, color-keyed bound edges and a heavyweight gripper backing for firm traction. Each set includes 2 front and 2 rear mats. Please specify carpet color and embroidery color when ordering. Made in USA! **Note:** Special order; must be pre-paid.

Plymouth A-Body

Barracuda Script Logo			
MA2109 1964-69	Barracuda	all transmissions	119.99 set
Valiant Script Logo			
MA2116 1962	Valiant	all transmissions	119.99 set
MA2117 1963-73	Valiant	all transmissions	119.99 set
Duster Logo			
MA2115 1970-73	Duster	all transmissions	131.99 set

Plymouth B-Body

Belvedere Script Logo			
MB1640 1962-65	Belvedere	automatic	119.99 set
MB1641 1962-65	Belvedere	4-speed	119.99 set
MB1642 1966-70	Belvedere	automatic	119.99 set
MB1643 1966-70	Belvedere	4-speed	119.99 set
Fury Script Logo			
MB1657 1962-64	Fury	automatic	119.99 set
MB1658 1962-64	Fury	4-speed	119.99 set
Sport Fury Script Logo			
MB1659 1963	Sport Fury	automatic	119.99 set
MB1659 1963	Sport Fury	4-speed	119.99 set
Satellite Script Logo			
MB1667 1965	Satellite	automatic	119.99 set
MB1668 1965	Satellite	4-speed	119.99 set
MB1669 1966-70	Satellite	automatic	119.99 set
MB1670 1966-70	Satellite	4-speed	119.99 set
MB1676 1971-73	Satellite	all transmissions	119.99 set
GTX Logo			
MB1661 1967-70	GTX	automatic	119.99 set
MB1662 1967-70	GTX	4-speed	119.99 set
MB1663 1971	GTX	4-speed	119.99 set

Plymouth E-Body

Barracuda Script Logo			
ME682 1970-73	Barracuda	all transmissions	119.99 set
'Cuda Script Logo			
ME683 1970-73	'Cuda	all transmissions	119.99 set
'Cuda On Wheels Logo			
ME693 1970-73	'Cuda	all transmissions	139.99 set

Cut Pile Mat Colors



801 black 818 ocean blue 825 maroon 859 lt jade 757 gold

Embroidery Colors

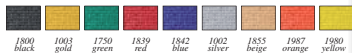

1974-76 Cut Pile Floor Mats



OFFICIAL LICENSED PRODUCT

Add the finishing touch to your interior with a set of officially licensed embroidered logo floor mats. Features an embroidered logo on the same carpet material used for our molded carpet sets for a perfect match, color-keyed bound edges and a heavyweight gripper backing for firm traction. Each set includes 2 front and 2 rear mats. Please specify carpet color and embroidery color when ordering. Made in USA! **Note:** Special order; must be pre-paid.

Dodge A-Body

Dart Logo			
MA2120 1974-76	Dart	all transmissions	119.99 set
Swinger Logo			
MA2121 1974-76	Dart	all transmissions	119.99 set

Dodge B-Body

Charger Logo			
MB1672 1974	Charger	all transmissions	119.99 set

Dodge E-Body

Challenger Script Logo			
ME692 1974	Challenger	all transmissions	119.99 set

Plymouth A-Body

Valiant Script Logo			
MA2125 1974-76	Valiant	all transmissions	119.99 set

Duster Logo			
MA2123 1974	Duster	all transmissions	119.99 set

Plymouth B-Body

Satellite Logo			
MB1675 1974	Satellite	all transmissions	119.99 set

Plymouth E-Body

Barracuda Script Logo			
ME688 1974	Barracuda	all transmissions	119.99 set
'Cuda Script Logo			
ME690 1974	'Cuda	all transmissions	119.99 set
'Cuda On Wheels Logo			
ME694 1974	'Cuda	all transmissions	119.99 set

Plymouth & Dodge Logo Floor Mats

1963-73 Logo Embroidered Loop Floor Mats

Show your Plymouth Pride or add a touch of distinction to your Dodge with a set of embroidered floor mats with a set of embroidered floor mats from Classic Industries®. Each set is embroidered with the Plymouth or Dodge logo on the front mats in your choice of nine embroidery thread colors. Made in USA!

Note: Special order, must be pre-paid.



MB1634501

Loop Floor Mat Colors

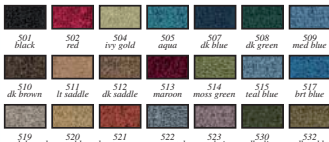

Embroidery Colors

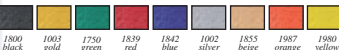

Dodge Script

Dodge A-Body			
MA2105 1963-66	Dart	all transmissions.....	119.99 set
MA2105 1967-73	Dart	all transmissions.....	119.99 set
MA2107 1971-72	Demon	all transmissions.....	119.99 set
Dodge B-Body			
MB1627 1966-70	Charger	automatic.....	119.99 set
MB1628 1966-70	Charger	4-speed.....	119.99 set
MB1629 1971-73	Charger	all transmissions.....	119.99 set
MB1632 1965	Coronet	automatic.....	119.99 set
MB1633 1965	Coronet	4-speed.....	119.99 set
MB1634 1966-70	Coronet	automatic.....	119.99 set
MB1635 1966-70	Coronet	4-speed.....	119.99 set
MB1636 1971-73	Coronet	all transmissions.....	119.99 set
MB1630 1969	Daytona	automatic.....	119.99 set
MB1631 1969	Daytona	4-speed.....	119.99 set
MB1637 1968-71	Super Bee	automatic.....	119.99 set
MB1638 1968-71	Super Bee	4-speed.....	119.99 set
Dodge E-Body			
ME1700 1970-73	Challenger	all transmissions.....	119.99 set

Plymouth Script

Plymouth A-Body			
MA2101 1964-69	Barracuda	all transmissions.....	119.99 set
MA2102 1962	Valiant	all transmissions.....	119.99 set
MA2103 1963-66	Valiant	all transmissions.....	119.99 set
MA2103 1967-73	Valiant	all transmissions.....	119.99 set
Plymouth B-Body			
MB1612 1962-65	Belvedere	automatic.....	119.99 set
MB1613 1962-65	Belvedere	4-speed.....	119.99 set
MB1614 1966-70	Belvedere	automatic.....	119.99 set
MB1615 1966-70	Belvedere	4-speed.....	119.99 set
MB1616 1962-64	Fury	automatic.....	119.99 set
MB1617 1962-64	Fury	4-speed.....	119.99 set
MB1618 1963	Sport Fury	4-speed & automatic.....	119.99 set
MB1620 1968-73	Road Runner	automatic.....	119.99 set
MB1621 1968-73	Road Runner	4-speed.....	119.99 set
MB1622 1965	Satellite	automatic.....	119.99 set
MB1623 1965	Satellite	4-speed.....	119.99 set
MB1624 1966-70	Satellite	automatic.....	119.99 set
MB1625 1966-70	Satellite	4-speed.....	119.99 set
MB1626 1971-73	Satellite	all transmissions.....	119.99 set
Plymouth E-Body			
ME1701 1970-73	Barracuda	all transmissions.....	119.99 set
ME1701 1970-73	Cuda	all transmissions.....	119.99 set

1974-76 Logo Embroidered Cut Pile Floor Mats

Add the perfect touch to finish off your interior restoration with a set of officially licensed embroidered logo floor mats. Features an embroidered logo on the same carpet material used for our molded carpet sets for a perfect match, color-keyed bound edges and a heavyweight gripper backing for firm traction.

Each set includes 2 front and 2 rear mats. Please specify carpet color and embroidery color when ordering.

Made in USA!

Note: Special order, must be pre-paid.



OFFICIAL LICENSED PRODUCT



Dodge script

Plymouth script

Cut Pile Mat Colors

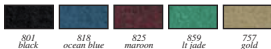

Embroidery Colors

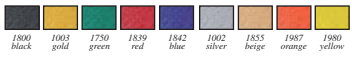

Dodge Script

Dodge A-Body			
MA2119 1974-76	Dart	all transmissions.....	119.99 set
Dodge B-Body			
MB1671 1974	Charger	all transmissions.....	119.99 set
Dodge E-Body			
ME691 1974	Challenger	all transmissions.....	119.99 set
Plymouth Script			
Plymouth A-Body			
MA2122 1974	Duster	all transmissions.....	119.99 set
MA2124 1974-76	Valiant	all transmissions.....	119.99 set
Plymouth B-Body			
MB1674 1974	Satellite	all transmissions.....	119.99 set
MB1673 1974-75	Road Runner	all transmissions.....	119.99 set
Plymouth E-Body			
ME687 1974	Barracuda	all transmissions.....	119.99 set
ME689 1974	Cuda	all transmissions.....	119.99 set

1970-76 A-Body Original Equipment Style Vinyl Floor Mats

Shield your carpet in authentic 1970's fashion with an OE-style 2 piece front floor mat set. If you want a completely original look for your interior while giving your carpet the ultimate in protection, these vinyl floor mats are exactly what you need. Available in

your choice of originally-offered colors to match or accent your interior. Please specify color when ordering. For all 1970-76 Dart, Duster, Demon, Scamp or Valiant models with automatic or manual transmission.



MA2100018

MA2100023

MA2100011



MA21000 1970-76 vinyl floor mat 102.99 set

A INTERIOR COMPONENTS

Mopar 4-Piece Logo Mats

Matched To Your Factory Style Interior Colors!

Choose from 11 Different Emblem Logos!



Protect your Delicate Carpet with Our 4-Piece Mopar Logo Floor Mats!

A Classic Industries® exclusive product! These tri-color carpeted rubber logo mats for 1960-76 Mopar models are manufactured to match factory style interior colors to perfectly complement your original interior. Sets include both front and rear mats and are made in the USA!



OFFICIAL LICENSED PRODUCT Made in USA

Barracuda Logo Floor Mats

Features the Barracuda emblem logo and color-matched carpeted panels on the mat to make your vehicle stand out.

MD690101	black	99.99 set
MD690102	red	99.99 set
MD690107	blue	99.99 set
MD690157	green	99.99 set

Dart Logo Floor Mats

Features the Dart emblem logo and color-matched carpeted panels on the mat to make your vehicle stand out.

MD690201	black	99.99 set
MD690202	red	99.99 set
MD690207	blue	99.99 set
MD690257	green	99.99 set

Duster Logo Floor Mats

Features the Duster emblem logo and color-matched carpeted panels on the mat to make your vehicle stand out.

MD690301	black	99.99 set
MD690307	blue	99.99 set
MD690357	green	99.99 set

Dodge Logo Floor Mats

Features the Dodge logo and color-matched carpeted panels on the mat to make your vehicle stand out.

MD690901	black	99.99 set
MD690902	red	99.99 set
MD690907	blue	99.99 set
MD690957	green	99.99 set

GTX Logo Floor Mats

Features the GTX emblem logo and color-matched carpeted panels on the mat to make your vehicle stand out.

MD690401	black	99.99 set
MD690402	red	99.99 set
MD690407	blue	99.99 set
MD690457	green	99.99 set

HEMI Logo Floor Mats

Features the HEMI emblem logo and color-matched carpeted panels on the mat to make your vehicle stand out.

MD690501	black	99.99 set
MD690502	red	99.99 set
MD690507	blue	99.99 set
MD690557	green	99.99 set

Plymouth Logo Floor Mats

Features the Plymouth emblem logo and color-matched carpeted panels on the mat to make your vehicle stand out.

MD690601	black	99.99 set
MD690602	red	99.99 set
MD690607	blue	99.99 set
MD690657	green	99.99 set

'Cuda Logo Floor Mats

Features the 'Cuda emblem logo and color-matched carpeted panels on the mat to make your vehicle stand out.

MD690701	black	99.99 set
MD690702	red	99.99 set
MD690707	blue	99.99 set
MD690757	green	99.99 set

Super Bee Logo Floor Mats

Features a multi-colored Super Bee emblem logo and color-matched carpeted panels on the mat to make your vehicle stand out.

MD690801	black	99.99 set
MD690807	blue	99.99 set
MD690857	green	99.99 set

Challenger Logo Floor Mats

Features a Challenger emblem logo and color-matched carpeted panels on the mat to make your vehicle stand out.

MD691001	black	99.99 set
MD691007	blue	99.99 set
MD691057	green	99.99 set

Charger Logo Floor Mats

Features a Charger emblem logo and color-matched carpeted panels on the mat to make your vehicle stand out.

MD691101	black	99.99 set
MD691102	red	99.99 set
MD691107	blue	99.99 set
MD691157	green	99.99 set

Custom Vinyl Floor Mats

Eliminate wear and tear on carpet while enhancing the vintage look of your classic Mopar's interior with these attractive "Custom Vintage" vinyl floor mats from Classic Industries®. Each 4-piece set features officially licensed molded-in logos on front and rear as well as custom cut profiles for a precise fit and

Sure-Grip anti-skid backing to keep them in place while driving. Cleans up easily with soap and water to provide years of carefree use. Available in your choice of 16 vintage colors to match or accent your interior. Specify color when ordering.

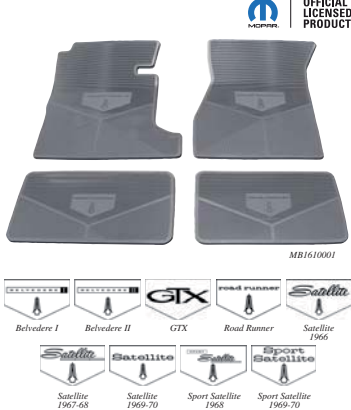
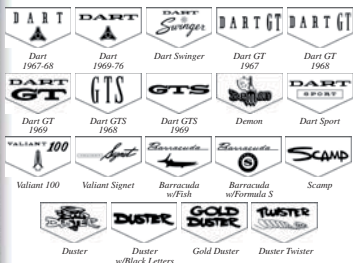
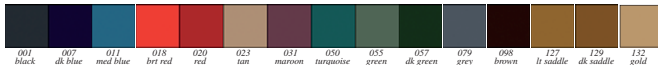

OFFICIAL
LICENSED
PRODUCT

1967-76 A-Body

Dart Logo	
MA435 1967-68 AT.....	127.99 set
MA436 1967-68 MT.....	127.99 set
MA447 1969-76 AT.....	127.99 set
MA448 1969-76 MT.....	127.99 set
Dart Swinger Logo	
MA401 1970-72 AT.....	127.99 set
MA402 1970-72 MT.....	127.99 set
MA403 1973-76 AT.....	127.99 set
MA404 1973-76 MT.....	127.99 set
Dart GT Logo	
MA437 1967 AT.....	127.99 set
MA438 1967 MT.....	127.99 set
MA439 1968 AT.....	127.99 set
MA440 1968 MT.....	127.99 set
MA445 1969 AT.....	127.99 set
MA444 1969 MT.....	127.99 set
Dart GT 1969 Logo	
MA411 1968 AT.....	127.99 set
MA442 1968 MT.....	127.99 set
MA445 1969 AT.....	127.99 set
MA446 1969 MT.....	127.99 set
Demon Logo	
MA413 1971-72 AT.....	127.99 set
MA414 1971-72 MT.....	127.99 set
Dart Sport Logo	
MA415 1973-76 AT.....	127.99 set
MA416 1973-76 MT.....	127.99 set
Valiant 100 Logo	
MA421 1967-69 AT.....	127.99 set
MA422 1967-69 MT.....	127.99 set

Valiant Signet Logo	
MA423 1967-69 AT.....	127.99 set
MA424 1967-69 MT.....	127.99 set
Barracuda with Fish Logo	
MA417 1967-69 AT.....	127.99 set
MA419 1967-69 MT.....	127.99 set
Barracuda with Formula S Logo	
MA418 1967-69 AT.....	127.99 set
MA420 1967-69 MT.....	127.99 set
Scamp Logo	
MA405 1970-72 AT.....	127.99 set
MA406 1970-72 MT.....	127.99 set
MA407 1973-76 AT.....	127.99 set
MA408 1973-76 MT.....	127.99 set
Duster Logo	
MA409 1970-72 AT.....	157.99 set
MA410 1970-72 MT.....	157.99 set
MA411 1973-76 AT.....	157.99 set
MA412 1973-76 MT.....	157.99 set
Duster Logo with Block Letters	
MA429 1973-76 AT.....	157.99 set
MA430 1973-76 MT.....	157.99 set
Gold Duster Logo	
MA431 1973-75 AT.....	157.99 set
MA432 1973-75 MT.....	157.99 set
Duster Twister with Logo	
MA433 1973-76 AT.....	157.99 set
MA434 1973-76 MT.....	157.99 set

1966-74 Plymouth B-Body

Belvedere I Logo	
MB2875 1966-67 AT.....	127.99 set
MB2876 1966-67 MT.....	127.99 set
Belvedere II Logo	
MB2877 1966-67 AT.....	127.99 set
MB2878 1966-67 MT.....	127.99 set
GTX Logo	
MB1608 1968-70 AT.....	127.99 set
MB1609 1968-70 MT.....	127.99 set
MB2873 1971 AT.....	127.99 set
MB2874 1971 MT.....	127.99 set
Road Runner Logo	
MB1610 1968-70 AT.....	127.99 set
MB1611 1968-70 MT.....	127.99 set
MB2869 1971-74 AT.....	127.99 set
MB2870 1971-74 MT.....	127.99 set
Satellite Logo	
MB2879 1966 AT.....	127.99 set
MB2880 1966 MT.....	127.99 set
MB2881 1967-68 AT.....	127.99 set
MB2882 1967-68 MT.....	127.99 set
MB2883 1969-70 AT.....	127.99 set
MB2884 1969-70 MT.....	127.99 set
Sport Satellite Logo	
MB2885 1968 AT.....	127.99 set
MB2886 1968 MT.....	127.99 set
MB2887 1969-70 AT.....	127.99 set
MB2888 1969-70 MT.....	127.99 set

Custom Vinyl Floor Mats

Eliminate wear and tear on carpet while enhancing the vintage look of your classic Mopar's interior with these attractive "Custom Vintage" vinyl floor mats from Classic Industries. Each 4-piece set features officially licensed molded-in logos on front and rear as well as custom cut profiles for a precise fit and

Sure-Grip anti-skid backing to keep them in place while driving. Cleans up easily with soap and water to provide years of carefree use. Available in your choice of 16 vintage colors to match or accent your interior. Specify color when ordering.



OFFICIAL LICENSED PRODUCT



MB1602001

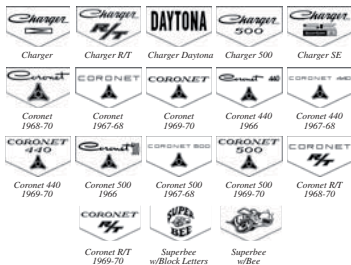

1966-74 Dodge B-Body

- Charger Logo**
 MB1600 1968-70 AT..... 127.99 set
 MB1601 1968-70 MT..... 127.99 set
 MB2863 1971-74 AT..... 127.99 set
 MB2864 1971-74 MT..... 127.99 set
- Charger RT Logo**
 MB1602 1968-70 AT..... 127.99 set
 MB1603 1968-70 MT..... 127.99 set
 MB2895 1971-74 AT..... 127.99 set
 MB2896 1971-74 MT..... 127.99 set
- Charger Daytona Logo**
 MB2857 1969 AT..... 127.99 set
 MB2858 1969 MT..... 127.99 set
- Charger 500 Logo**
 MB2859 1969-70 AT..... 127.99 set
 MB2860 1969-70 MT..... 127.99 set
- Charger SE Logo**
 MB2861 1969-70 AT..... 127.99 set
 MB2862 1969-70 MT..... 127.99 set
- Corone Logo**
 MB1604 1968-70 AT..... 127.99 set
 MB1605 1968-70 MT..... 127.99 set
 MB2827 1967-68 AT..... 127.99 set
 MB2828 1967-68 MT..... 127.99 set
 MB2835 1969-70 AT..... 127.99 set
 MB2836 1969-70 MT..... 127.99 set

- Coronet Logo**
 MB2823 1966 AT..... 127.99 set
 MB2824 1966 MT..... 127.99 set
 MB2829 1967-68 AT..... 127.99 set
 MB2830 1967-68 MT..... 127.99 set
 MB2837 1969-70 AT..... 127.99 set
 MB2838 1969-70 MT..... 127.99 set
- Coronet 440 Logo**
 MB2825 1966 AT..... 127.99 set
 MB2826 1966 MT..... 127.99 set
 MB2831 1967-68 AT..... 127.99 set
 MB2832 1967-68 MT..... 127.99 set
 MB2839 1969-70 AT..... 127.99 set
 MB2840 1969-70 MT..... 127.99 set
- Coronet RT Logo**
 MB1606 1968-70 AT..... 127.99 set
 MB1607 1968-70 MT..... 127.99 set
 MB2841 1969-70 AT..... 127.99 set
 MB2842 1969-70 MT..... 127.99 set
- Superbee w/Block Letters & Bee Logo**
 MB2843 1968-70 AT..... 157.99 set
 MB2844 1968-70 MT..... 157.99 set
- Superbee with Bee Logo Only**
 MB2845 1968-70 AT..... 157.99 set
 MB2846 1968-70 MT..... 157.99 set



MB2847055



426 Hemi

Hemi

Pentastar

Dodge/Plymouth B-Body

426 Hemi Logo

- MB2847 1966-67 AT..... 127.99 set
 MB2848 1966-67 MT..... 127.99 set

Hemi Logo

- MB2849 1968-70 AT..... 127.99 set
 MB2850 1968-70 MT..... 127.99 set

Pentastar Logo

- MB2889 1966-70 AT..... 127.99 set
 MB2890 1966-70 MT..... 127.99 set



ME675001



Barracuda

Cuda

Challenger

Challenger RT

1970-74 E-Body

Barracuda Logo

- ME650 1970 AT..... 127.99 set
 ME651 1970 MT..... 127.99 set
 ME652 1971 AT..... 127.99 set
 ME653 1971 MT..... 127.99 set
 ME654 1972 AT..... 127.99 set
 ME655 1972 MT..... 127.99 set
 ME656 1973-74 AT..... 127.99 set
 ME657 1973-74 MT..... 127.99 set

Cuda Logo

- ME658 1970 AT..... 127.99 set
 ME659 1970 MT..... 127.99 set
 ME660 1971 AT..... 127.99 set
 ME661 1971 MT..... 127.99 set
 ME662 1972 AT..... 127.99 set
 ME663 1972 MT..... 127.99 set
 ME664 1973-74 AT..... 127.99 set
 ME665 1973-74 MT..... 127.99 set

Challenger Logo

- ME667 1970 AT..... 127.99 set
 ME668 1970 MT..... 127.99 set
 ME669 1971 AT..... 127.99 set
 ME670 1971 MT..... 127.99 set
 ME671 1972 AT..... 127.99 set
 ME672 1972 MT..... 127.99 set
 ME673 1973-74 AT..... 127.99 set
 ME674 1973-74 MT..... 127.99 set

Challenger RT Logo

- ME675 1970 AT..... 127.99 set
 ME676 1970 MT..... 127.99 set
 ME677 1971 AT..... 127.99 set
 ME678 1971 MT..... 127.99 set
 ME679 1972 AT..... 127.99 set
 ME680 1972 MT..... 127.99 set

Bucket Seat Upholstery

— DODGE A-BODY • 1963-67 Dart GT —



Made in USA

Vinyl Color Chart

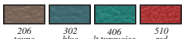

Carpet Color Chart

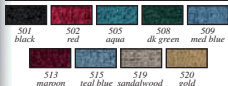

1963 Dart GT Upholstery

Bison grain inserts and outers for a factory look and feel. Features carpeted stretch panel located at the rear of the seat bottom. Made in USA.

Note: Special order, must be pre-paid. Please add three digit vinyl color code to part number and specify carpet color when ordering.

- MA601 1963 front buckets 435.99 pr
- MA602 1963 hardtop rear seat 264.99 ea
- MA603 1963 convertible rear seat 264.99 ea



Made in USA

Vinyl Color Chart



Carpet Color Chart

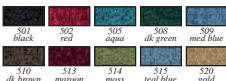

1964 Dart GT Upholstery

Heat sealed Bison grain inserts and outers with heat sealed chrome emblem for a factory look and feel. Available with silver tinsel or color of vinyl cordwelt around seat and back panel inserts. The stretch panel is the carpeted portion of the seat cover located at the rear of the seat bottom. Specify carpeted stretch panel color by number and name when ordering. Made in USA.

*Note: Special order, must be pre-paid. Please specify carpet color when ordering. *No further discounts apply.*

Front Buckets

- With Color Matching Cordwelt**
- MA606100 1964 black 509.99 pr
 - MA606309 1964 blue 509.99 pr
 - MA606510 1964 red 509.99 pr
- With Silver Tinsel Cordwelt**
- MA606101 1964 black 509.99 pr
 - MA606300 1964 blue 509.99 pr
 - MA606509 1964 red 509.99 pr
 - MA606409* 1964 olive - NOS 954.99 pr

Hardtop Rear Seat

- With Color Matching Cordwelt**
- MA607100 1964 black 474.99 ea
 - MA607309 1964 blue 474.99 ea
 - MA607510 1964 crimson red 474.99 ea
- With Silver Tinsel Cordwelt**
- MA607101 1964 black 474.99 ea
 - MA607300 1964 blue 474.99 ea
 - MA607509 1964 red 474.99 ea
 - MA607409* 1964 olive - NOS 899.99 ea

Convertible Rear Seat

- With Color Matching Cordwelt**
- MA608100 1964 black 474.99 ea
 - MA608309 1964 blue 474.99 ea
 - MA608510 1964 red 474.99 ea
- With Silver Tinsel Cordwelt**
- MA608101 1964 black 474.99 ea
 - MA608300 1964 blue 474.99 ea
 - MA608509 1964 red 474.99 ea
 - MA608409* 1964 olive - NOS 899.99 ea



MA620100

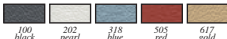

Made in USA

1966 Dart GT Upholstery

Cologne grain inserts and outers for a factory look and feel. New molded foam is available for this model in the "Seat Foam" listings. Made in USA.

- Note: Please add three digit color code when ordering.*
- MA620 1966 front buckets 399.99 pr
 - MA621 1966 hardtop rear seat 276.99 ea
 - MA622 1966 convertible rear seat 276.99 ea



Made in USA

Vinyl Color Chart

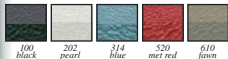

Carpet Color Chart

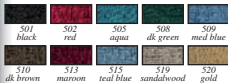

1965 Dart GT Upholstery

Cologne grain inserts and Bison grain outers for a factory look and feel. Features carpeted stretch panel located at the rear of the seat bottom. Made in USA.

Note: Special order, must be pre-paid. Please add three digit vinyl color code to part number and specify carpet color when ordering.

- MA611 1965 front buckets 435.99 pr
- MA612 1965 hardtop rear seat 292.99 ea
- MA613 1965 convertible rear seat 292.99 ea



Made in USA

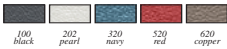

1967 Dart GT Seat Upholstery

Heat sealed Cologne grain inserts and outers for a factory look and feel. Features factory style stitching pattern and correct high density foam backing stitched into place as original. Made in USA.

- Important: Metal emblems are not included.*
- Note: Please add three digit color code when ordering.*
- MA630 1967 front buckets 399.99 pr
 - MA631 1967 hardtop rear seat 276.99 ea
 - MA632 1967 convertible rear seat 276.99 ea

A INTERIOR COMPONENTS

Bucket Seat Upholstery

— PLYMOUTH A-BODY • 1964-67 Barracuda, Valiant —



Made in USA

Vinyl Color Chart

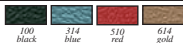

Carpet Color Chart



1964-65 Barracuda Upholstery

Heat sealed Bison grain inserts and outers for a factory look and feel. The stretch panel is the carpeted portion of the seat cover located at the rear of the seat bottom.

Important: Brass vent grommets not included. Reupholster from original seats.
Note: Special order, must be pre-paid. Please add three digit vinyl color code to part number and specify carpet color when ordering.
MA604 1964-65 front buckets..... 435.99 pr
MA605 1964-65 rear seat..... 399.99 ea

Vinyl Color Chart

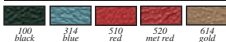

Carpet Color Chart

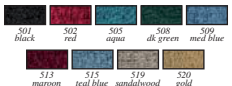

1965 Valiant Signet Upholstery

Heat sealed Bison grain inserts and outers for a factory look and feel. The stretch panel is the carpeted portion of the seat cover located at the rear of the seat bottom.

Note: Special order, must be pre-paid. Please add three digit vinyl color code to part number and specify carpet color when ordering.
MA604 1965 front buckets..... 435.99 pr
MA614 1965 hardtop rear seat..... 399.99 pr
MA615 1965 convertible rear seat..... 399.99 ea



Made in USA

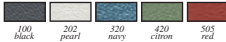

1966 Barracuda Upholstery

Heat sealed Cologne grain inserts and outers for a factory look and feel. New molded foam is available for this model in the "Seat Foam" listings. Made in USA.
Important: Brass vent grommets not included. Reupholster from original seats.
Note: Please add three digit color code when ordering.
MA616 1966 front buckets..... 399.99 pr
MA617 1966 rear seat..... 384.99 ea

Made in USA



Made in USA



1967 Barracuda Upholstery

Cologne grain inserts and outers for a factory look and feel. Made in USA.
Note: Please add three digit color code when ordering. *No further discounts apply.

Front Buckets
MA625* 1967 gold - NOS..... 836.99 pr
MA625 1967 all other colors..... 399.99 pr
Hardtop Rear Seat
MA627* 1967 gold - NOS..... 711.99 ea
MA627 1967 all other colors..... 276.99 ea
Convertible Rear Seat
MA628* 1967 gold - NOS..... 711.99 ea
MA628 1967 all other colors..... 276.99 ea
Fastback Rear Seat
MA629* 1967 gold - NOS..... 711.99 ea
MA629 1967 all other colors..... 276.99 ea



Vinyl Color Chart

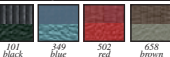

Carpet Color Chart

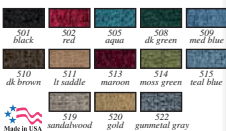

Made in USA

1964 Valiant Signet Upholstery

1/16 Rib grain inserts with heat sealed chrome accent band and Bison grain outers for a factory look and feel. Each seat features silver accent web sewn in. The stretch panel is the carpeted portion of the seat cover located at the rear of the seat bottom. Made in USA.
Note: Special order, must be pre-paid. Please add three digit vinyl color code to part number and specify carpet color when ordering. *No further discounts apply.

Front Buckets
MA609* 1964 brown - NOS..... 741.99 pr
MA609 1964 all other colors..... 464.99 pr
Hardtop Rear Seat
MA610* 1964 brown - NOS..... 692.99 ea
MA610 1964 all other colors..... 369.99 ea

Made in USA



Made in USA

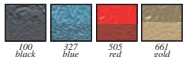

1966 Valiant Signet Upholstery

Cologne grain inserts with Ostrich grain upper insert and Cologne grain outers for a factory look and feel. Made in USA.
Note: Please add three digit color code when ordering. *No further discounts apply.

Front Buckets
MA623* 1966 gold - NOS..... 574.99 pr
MA623 1966 all other colors..... 399.99 pr
Convertible Rear Seat
MA624* 1966 gold - NOS..... 444.99 ea
MA624 1966 all other colors..... 276.99 ea

Bucket Seat Upholstery

— DODGE & PLYMOUTH A-BODY • 1968-69 —



Made in USA



1968 Barracuda Standard Seat Upholstery

Bucket and bench seat upholstery for standard models. Cologne grain inserts and outers for a factory look and feel. Made in USA.

Note: Please add three digit color code when ordering.

MA639	1968	front buckets	404.99	pr
MA640	1968	hardtop rear seat	284.99	ea
MA641	1968	convertible rear seat	284.99	ea
MA642	1968	fastback rear seat	284.99	ea



Made in USA

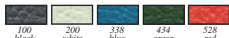

1969 Barracuda Standard Upholstery

Coachman grain inserts and outers for a factory look and feel. Made in USA.

Note: Please add three digit color code when ordering.

MA655	1969	front buckets	404.99	pr
MA657	1969	hardtop rear seat	284.99	ea
MA658	1969	convertible rear seat	284.99	ea
MA659	1969	fastback rear seat	284.99	ea



Made in USA



1968 Dart GT & Dart GTS Upholstery

Ascot grain inserts with KV grain pleat and Cologne grain outers for a factory look and feel. Made in USA.

Important: Metal emblems are not included.

Note: Please add three digit color code when ordering.

Front Buckets

MA648	1968	gold	478.99	pr
MA648	1968	all other colors	478.99	pr

Hardtop Rear Seat

MA649	1968	gold	425.99	ea
MA649	1968	all other colors	331.99	ea

Convertible Rear Seat

MA650	1968	gold	425.99	ea
MA650	1968	all other colors	331.99	ea



Made in USA



1968 Barracuda Deluxe Seat Upholstery

Specifically produced to match the original in weight and grain. Features dielectrically heat sealed seams and the original factory stitching pattern. Cologne and Rosette grain inserts and Cologne grain outers for a factory look and feel. Made in USA.

Note: Please add three digit color code when ordering.

MA644	1968	front buckets	404.99	pr
MA645	1968	hardtop rear seat	284.99	ea
MA646	1968	convertible rear seat	284.99	ea
MA647	1968	fastback rear seat	284.99	ea



Made in USA

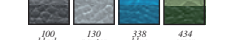

1969 Barracuda Deluxe Upholstery

El Paso grain inserts and Coachman grain outers for a factory look and feel. Made in USA.

Important: Metal emblems are not included.

MA660	1969	front buckets	404.99	pr
MA662	1969	hardtop rear seat	284.99	ea
MA663	1969	convertible rear seat	284.99	ea
MA664	1969	fastback rear seat	284.99	ea



Made in USA



1969 Dart GT & Dart GTS Upholstery

Dakota grain inserts and outers for a factory look and feel. Made in USA.

Note: Please add three digit color code when ordering.

MA665	1969	front buckets	404.99	pr
MA667	1969	hardtop rear seat	284.99	pr
MA668	1969	convertible rear seat	284.99	ea

A INTERIOR COMPONENTS

Bucket Seat Upholstery

— DODGE & PLYMOUTH A-BODY • 1970-76 —



Legendary
AUTO INTERIORS, LTD.

MA701100

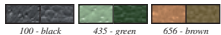

1970 Dart Swinger 340 & Dart GT Upholstery

Derma grain inserts and Coachman grain outers for a factory look and feel. Made in USA.

Notes: Please add three digit color code when ordering.
MA701 1970 front buckets..... 421.99 pr
MA702 1970 hardtop rear seat..... 284.99 ea



Legendary
AUTO INTERIORS, LTD.

MA708100



1970 Duster & Duster 340 Upholstery

El Paso grain inserts and Coachman grain outers for a factory look and feel. Made in USA.

Important: Metal emblems are not included.
Notes: Please add three digit color code when ordering.
MA708 1970 front buckets..... 404.99 pr
MA713 1970 rear seat..... 284.99 ea



Legendary
AUTO INTERIORS, LTD.

MA717152



1971 Demon, Duster Upholstery

El Paso grain inserts and Coachman grain outers for a factory look and feel. Fits 1971 Demon, Demon 340, Duster, Duster 340. Made in USA.

Notes: Please add three digit color code when ordering.
MA717 1971 front buckets..... 404.99 pr
MA718 1971 rear seat..... 284.99 ea



Legendary
AUTO INTERIORS, LTD.

MA728100



1972 Demon, Duster Upholstery

Coachman grain inserts and Cologne grain outers for a factory look and feel. Fits 1972 Demon, Demon 340, Duster, Duster 340.

Important: Metal emblems are not included.
Notes: Please add three digit color code when ordering.
MA728 1972 front buckets..... 421.99 pr
MA723 1972 rear seat..... 284.99 ea



Legendary
AUTO INTERIORS, LTD.

MA732253



1973 Dart Sport, Duster Upholstery

Shallow Elk grain inserts and Coachman grain outers for a factory look and feel. Fits 1973 Dart Sport, Dart Sport 340, Duster, Duster 340. Made in USA.

*Notes: *No further discounts apply.*
DISCOUNTED
PRICES
Front Buckets
MA732100 1973 black..... 404.99 pr
MA732200 1973 white..... 404.99 pr
MA732253* 1973 parchment - NOS..... 669.99 pr

Fixed Rear Seat
MA733100 1973 black..... 276.99 ea
MA733200 1973 white..... 276.99 ea
MA733253* 1973 parchment - NOS..... 539.99 ea



Legendary
AUTO INTERIORS, LTD.

"Hang-10"

1974-75 Dart Sport "Hang-10" Upholstery

Hang-10 multi-color striped inserts and Oxford grain outers for a factory look and feel. Fits 1974-75 Dart Sport and Dart Sport 360. Made in USA.

Note: No further discounts apply.
Front Buckets
MA755800 1974-75 - NOS..... 819.99 pr
Fold-Down Rear Seat
MA756800 1974-75 - NOS..... 709.99 ea

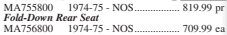

Legendary
AUTO INTERIORS, LTD.



Legendary
AUTO INTERIORS, LTD.

MA735200



1974 Dart Sport, Duster Upholstery

Shallow Elk grain inserts and Oxford grain outers for a factory look and feel. Fits 1974 Dart Sport, Dart Sport 360, Duster, Duster 360. Made in USA.

*Note: Please add three digit color code when ordering. *No further discounts apply.*
Front Buckets
MA735 1974 black or white..... 404.99 pr
MA735* 1974 parchment..... 945.99 pr

Fixed Rear Seat
MA737 1974 black or white..... 276.99 ea
MA737* 1974 parchment..... 814.99 ea
MA738 1974 black or white..... 276.99 ea
MA738* 1974 parchment..... 814.99 ea

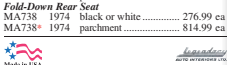

Legendary
AUTO INTERIORS, LTD.



1975-76 Dart, Duster, Scamp Upholstery

Shallow Elk grain inserts and Oxford grain outers for a factory look and feel. Fits Dart Swinger, Dart Sport, Dart Sport 360, Duster, Duster 360 or Scamp. Made in USA.

Note: Please add three digit color code when ordering.
MA757 1975-76 front buckets..... 404.99 pr
MA758 1975-76 center cushion/armrest 81.99 ea
MA737 1975-76 fixed rear seat..... 276.99 ea
MA738 1975-76 fold-down rear seat..... 276.99 ea

Bucket Seat Upholstery

— DODGE B-BODY • 1963-64 —

Carpeted Stretch Panel

Our 1963 upholstery features a carpeted stretch panel just like the originals. Don't forget to choose the stretch panel color when ordering.



Legendary
by RESTORATION USA

MB601207

Correct Manufacturing Techniques

Professionally produced using exact factory specifications. Correct manufacturing techniques allow you to achieve a factory appearance with easier installation.

Correct Grains and Colors

Each style and color is specifically produced to match the original in weight and grain. You'll get the factory-fresh appearance you want while maintaining the authenticity of your interior.

1963 Polara 500 Upholstery Colors

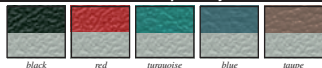

1963 Polara 500 Carpeted Stretch Panel Colors



1963 Polara 500 Upholstery

Bison grain inserts with Bison grain accent and Bison grain outers for a factory look and feel. Specify carpet color of stretch panel when ordering. The stretch panel is the carpeted portion of the seat cover located at the rear of the seat bottom. Made in USA. Note: Special order; must be pre-paid. Please specify three digit carpeted stretch panel color code and name when ordering. No further discounts apply.

Front Buckets

MB601113	1963	black	464.99	pr
MB601514	1963	red	464.99	pr
MB601407	1963	turquoise	464.99	pr
MB601303	1963	blue	464.99	pr
MB601207	1963	taupe	464.99	pr

Hardtop Rear Seat

MB602113	1963	black	427.99	ea
MB602514	1963	red	427.99	ea
MB602407	1963	turquoise	427.99	ea
MB602303	1963	blue	427.99	ea
MB602207	1963	taupe	427.99	ea

Convertible Rear Seat

MB603113	1963	black	427.99	ea
MB603514	1963	red	427.99	ea
MB603407	1963	turquoise	427.99	ea
MB603303	1963	blue	427.99	ea
MB603207	1963	taupe	427.99	ea

Carpeted Stretch Panel

Our 1964 upholstery features a carpeted stretch panel just like the originals. Don't forget to choose the color of the stretch panel when ordering.



Made in USA



The Details Matter

When it comes to details, the word is *Legendary!* From the seams which feature the original factory stitching pattern to the accent welting that is available in original factory colors.

MB604100

1964 Polara 500 Upholstery Colors

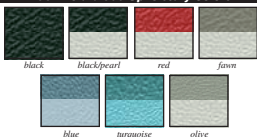

1964 Polara 500 Carpeted Stretch Panel Colors

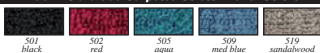

1964 Polara 500 Upholstery

Bison grain inserts with Bison grain accent and Bison grain outers for a factory look and feel. Specify carpet color of stretch panel when ordering. The stretch panel is the carpeted portion of the seat cover located at the rear of the seat bottom. Made in USA. Note: Special order; must be pre-paid. Please specify three digit carpeted stretch panel color code and name when ordering. No further discounts apply.

Front Buckets

MB604100	1964	black/black accent	464.99	pr
MB604101	1964	black/black accent & silver insert welt	464.99	pr
MB604114	1964	black/black accent & silver accent welt	464.99	pr
MB604124	1964	black/pearl white accent	464.99	pr
MB604511	1964	red/pearl white accent	464.99	pr
MB604611	1964	fawn/pearl white accent	464.99	pr
MB604311*	1964	blue/net powder blue accent - NOS	616.99	pr
MB604417*	1964	turquoise/lt med turq accent - NOS	616.99	pr
MB604413*	1964	olive/pearl white accent - NOS	961.99	pr

Hardtop Rear Seat

MB605100	1964	black/black accent	427.99	ea
MB605101	1964	black/black accent & silver insert welt	427.99	ea
MB605114	1964	black/black accent & silver accent welt	427.99	ea
MB605124	1964	black/pearl white accent	427.99	ea
MB605511	1964	red/pearl white accent	427.99	ea
MB605611	1964	fawn/pearl white accent	427.99	ea
MB605311*	1964	blue/net powder blue accent - NOS	574.99	ea
MB605417*	1964	turquoise/lt med turq accent - NOS	574.99	ea
MB605413*	1964	olive/pearl white accent - NOS	851.99	ea

Convertible Rear Seat

MB606100	1964	black/black accent	427.99	ea
MB606101	1964	black/black accent & silver insert welt	427.99	ea
MB606124	1964	black/pearl white accent	427.99	ea
MB606511	1964	red/pearl white accent	427.99	ea
MB606611	1964	fawn/pearl white accent	427.99	ea
MB606311*	1964	blue/net powder blue accent - NOS	574.99	ea
MB606417*	1964	turquoise/lt med turq accent - NOS	574.99	ea
MB606413*	1964	olive/pearl white accent - NOS	851.99	ea

Bucket Seat Upholstery

— PLYMOUTH B-BODY • 1963-64 —

Carpeted Stretch Panel

Our 1963 upholstery features a carpeted stretch panel just like the originals. Don't forget to choose the color of the stretch panel when ordering.



Legendary
AUTO RESTORATION CO.

The Details Matter

From factory stitch pattern seams to the heat sealed chrome emblem and accent welting, these sets have it all.

MB607117

Correct Manufacturing Techniques

Professionally produced using exact factory specifications. Correct manufacturing techniques allow you to get a quality factory appearance with easier installation.



Correct Grains and Colors

Each style and color is specifically produced to match the original in weight and grain. You can be assured of achieving the desired results and a quality interior authenticity and a quality factory fresh appearance.

1963 Sport Fury Upholstery Colors

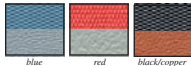

blue red black/copper

1963 Sport Fury Carpeted Stretch Panel Colors

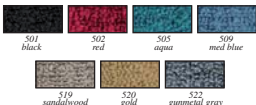

1963 Sport Fury Upholstery



Pinpoint grain inserts and heat sealed center accent strip with chrome emblem and Bison grain outlets for a factory look and feel. The stretch panel is the carpeted portion of the seat cover located at the rear of the seat bottom. Made in USA.

Note: Special order, must be pre-paid. Please specify three digit carpeted stretch panel color code and name when ordering.

Front Buckets

MB607305	1963	blue/light blue accent	524.99	pr
MB607513	1963	red/dark white accent	524.99	pr
MB607117	1963	black/copper accent	664.99	pr

Hardtop Rear Seat

MB608305	1963	blue/light blue accent	487.99	ea
MB608513	1963	red/dark white accent	487.99	ea
MB608117	1963	black/copper accent	619.99	ea

Convertible Rear Seat

MB609305	1963	blue/light blue accent	487.99	ea
MB609513	1963	red/dark white accent	487.99	ea
MB609117	1963	black/copper accent	619.99	ea

Carpeted Stretch Panel

Our 1964 upholstery features a carpeted stretch panel just like the originals. Don't forget to choose the color of the stretch panel when ordering.



Legendary
AUTO RESTORATION CO.

The Details Matter

From the dielectrically heat sealed seams and the original factory stitching pattern to the accent welting, careful attention is paid to every detail. Available in original factory colors.

MB610319



1964 Sport Fury Upholstery Colors

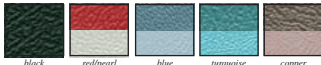

black red/pearl blue turquoise copper

1964 Sport Fury Carpeted Stretch Panel Colors

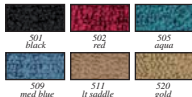

501 black 502 red 505 aqua 509 med blue 511 lt saddle 520 gold

1964 Sport Fury Upholstery

Bison grain inserts with heat sealed upper insert and Bison grain outlets for a factory look and feel. Specify carpet color of stretch panel when ordering. The stretch panel is the carpeted portion of the seat cover located at the rear of the seat bottom. Made in USA.

Note: Special order, must be pre-paid. Please specify three digit carpeted stretch panel color code and name when ordering.

Front Buckets

MB610100	1964	black/black accent	435.99	pr
MB610503	1964	red/pearl white accent w/silver welt	435.99	pr
MB610511	1964	red/pearl white accent	435.99	pr
MB610319	1964	blue/lt med blue accent	606.99	pr
MB610417	1964	turquoise/lt met turquoise accent	606.99	pr
MB610609	1964	copper/metallic rosewood accent	606.99	pr

Hardtop Rear Seat

MB611100	1964	black/black accent	412.99	ea
MB611503	1964	red/pearl white accent w/silver welt	412.99	ea
MB611511	1964	red/pearl white accent	412.99	ea
MB611319	1964	blue/lt med blue accent	562.99	ea
MB611417	1964	turquoise/lt met turquoise accent	562.99	ea
MB611609	1964	copper/metallic rosewood accent	562.99	ea

Convertible Rear Seat

MB612100	1964	black/black accent	412.99	ea
MB612503	1964	red/pearl white accent w/silver welt	412.99	ea
MB612511	1964	red/pearl white accent	412.99	ea
MB612319	1964	blue/lt med blue accent	562.99	ea
MB612417	1964	turquoise/lt met turquoise accent	562.99	ea
MB612609	1964	copper/metallic rosewood accent	562.99	ea

Bucket Seat Upholstery

— DODGE B-BODY • 1965-67 —

Heavy Foam Backing As Original

Using quality materials is essential when restoring an interior. Although many manufacturers neglect this area, we insist on offering OEM-quality upholstery which features correct high density foam backing stitched into place as original. Once installed, you'll feel the difference!



The Details Matter

Featuring dielectrically heat sealed seams with the correct factory stitching pattern, careful attention is paid to every detail of the original upholstery.

MB630317

Carpeted Stretch Panel

Our 1965 upholstery features a carpeted stretch panel just like the originals. Don't forget to choose the color of the stretch panel when ordering.

1965 Coronet Upholstery Colors

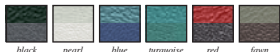

1965 Coronet Carpeted Stretch Panel Colors

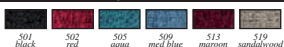

1965 Coronet 500 Upholstery

Heat sealed Bison grain inserts with Cologne or Pembroke grain accent and Bison grain outers for a factory look and feel. Specify carpet color of stretch panel when ordering. The stretch panel is the carpeted portion of the seat cover located at the rear of the seat bottom. Made in USA.

Note: Special order, must be pre-paid. Please specify three digit carpeted stretch panel color code and name when ordering.

Front Buckets

MB630100	1965	black	464.99	pr
MB630202	1965	pearl	464.99	pr
MB630317	1965	blue	464.99	pr
MB630419	1965	turquoise	464.99	pr
MB630525	1965	red	464.99	pr
MB630613	1965	fawn	535.99	pr

Hardtop Rear Seat

MB631100	1965	black	424.99	ea
MB631202	1965	pearl	424.99	ea
MB631317	1965	blue	424.99	ea
MB631419	1965	turquoise	424.99	ea
MB631525	1965	red	424.99	ea
MB631613	1965	fawn	499.99	ea

Convertible Rear Seat

MB632100	1965	black	427.99	ea
MB632202	1965	pearl	427.99	ea
MB632317	1965	blue	427.99	ea
MB632419	1965	turquoise	427.99	ea
MB632525	1965	red	427.99	ea
MB632613	1965	fawn	499.99	ea



MB645100

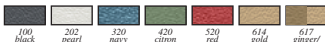

Made in USA

1966 Charger Upholstery



Cologne grain inserts and outers for a factory look and feel. Made in USA.

Note: Please add three digit color code when ordering.

MB645	1966	front buckets	399.99	pr
MB646	1966	rear buckets	276.99	pr

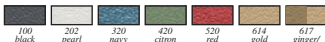

Made in USA

1966 Coronet 500 Upholstery



Cologne grain inserts and outers for a factory look and feel. Made in USA.

Note: Please add three digit color code when ordering.

MB652	1966	front buckets	399.99	pr
MB653	1966	center cushion/armrest	81.99	ea
MB654	1966	hardtop rear seat	276.99	ea
MB654	1966	convertible rear seat	276.99	ea



Made in USA



MB674202

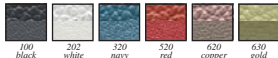

1967 Charger Upholstery

Bambino grain inserts and Cologne grain outers for a factory look and feel. Made in USA.

Important: Metal emblems not included.

Note: Please add three digit color code when ordering.

MB674	front buckets	399.99	pr
MB675	rear buckets	276.99	pr

1967 Coronet Upholstery

Bambino grain inserts and Cologne grain outers for a factory look and feel. Fits Coronet 500 & R/T. Made in USA.

Important: Metal emblems not included.

Note: Please add three digit color code when ordering.

MB674	front buckets	399.99	pr
MB652	center armrest	81.99	ea
MB676	hardtop rear seat	276.99	ea
MB677	convert rear seat	276.99	ea

A INTERIOR COMPONENTS

Bucket Seat Upholstery

— PLYMOUTH B-BODY • 1965-67 —

Heavy Foam Backing As Original

Using quality materials is essential when replacing your interior. Although many manufacturers neglect this area, we insist on offering OEM-quality upholstery which features correct high density foam backing stitched into place as original. Once installed, you'll feel the difference!



The Details Matter

From the dielectrically heat sealed seams with the correct factory stitching pattern and correct officially licensed Plymouth logo, careful attention is paid to every detail of the original upholstery.

MB633415



Carpeted Stretch Panel

Our 1965 upholstery features a carpeted stretch panel just like the originals. Don't forget to choose the color of the stretch panel when ordering.

1965 Satellite Upholstery Colors

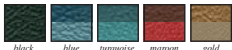

black blue turquoise maroon gold

1965 Satellite Carpeted Stretch Panel Colors

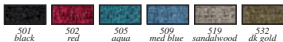

501 black 502 red 505 aqua 509 med blue 519 sandalwood 522 dk gold

1965 Satellite Vinyl Upholstery

Heat sealed Bison grain inserts and outers for a factory look and feel. Available with silver tinsel or color of vinyl cordweli around seat and back panel inserts. The stretch panel is the carpeted portion of the seat cover located at the rear of the seat bottom. Made in USA.

*Note: Special order, must be pre-paid. Please specify three digit carpeted stretch panel color code and name when ordering. *No further discounts apply.*

Front Buckets

MB633101	1965	black with silver welt.....	479.99	pr
MB633315	1965	blue.....	479.99	pr
MB633301	1965	blue with silver welt.....	479.99	pr
MB633415	1965	turquoise.....	479.99	pr
MB633521	1965	maroon.....	479.99	pr
MB633531	1965	maroon with silver welt.....	479.99	pr
MB633625*	1965	gold - NOS.....	709.99	pr
MB633681*	1965	gold with silver welt - NOS.....	709.99	pr

Hardtop Rear Seat

MB634101	1965	black with silver welt.....	435.99	ea
MB634315	1965	blue.....	435.99	ea
MB634301	1965	blue with silver welt.....	435.99	ea
MB634415	1965	turquoise.....	435.99	ea
MB634521	1965	maroon.....	435.99	ea
MB634531	1965	maroon with silver welt.....	435.99	ea
MB634625*	1965	gold - NOS.....	622.99	ea
MB634681*	1965	gold with silver welt - NOS.....	622.99	ea

Convertible Rear Seat

MB635101	1965	black with silver welt.....	435.99	ea
MB635315	1965	blue.....	435.99	ea
MB635301	1965	blue with silver welt.....	435.99	ea
MB635415	1965	turquoise.....	435.99	ea
MB635521	1965	maroon.....	435.99	ea
MB635531	1965	maroon with silver welt.....	435.99	ea
MB635625*	1965	gold - NOS.....	622.99	ea



MB655100

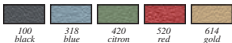

100 black 318 blue 420 citron 520 red 614 gold



1966 Satellite Vinyl Upholstery

Heat sealed Cologne grain inserts with Western Scroll strips and Cologne grain outers for a factory look and feel. Made in USA.

Note: Please add three digit color code when ordering.

MB655	1966	front buckets.....	474.99	pr
MB652	1966	center cushion/armrest.....	81.99	ea
MB656	1966	hardtop rear seat.....	452.99	ea
MB657	1966	convertible rear seat.....	452.99	ea



MB678100

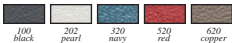

100 black 202 pearl 320 navy 520 red 620 copper



1967 Satellite & GTX Vinyl Upholstery

Heat sealed Cologne grain inserts with Western Scroll strips and Cologne grain outers for a factory look and feel. Made in USA.

Note: Please add three digit color code when ordering.

MB678	1967	front buckets.....	427.99	pr
MB652	1967	center cushion/armrest.....	81.99	ea
MB679	1967	hardtop rear seat.....	412.99	ea
MB680	1967	convertible rear seat.....	412.99	ea

Bucket Seat Upholstery

— DODGE B-BODY • 1968-69 —



MB695202

Legendary
AUTO RESTORATION LTD.

Made in USA

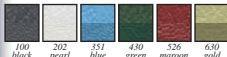

1968 Coronet 500 & Coronet R/T Upholstery

Ascot grain inserts and Cologne grain outers for a factory look and feel. Made in USA.

Note: Please add three digit color code when ordering.

Front Buckets		
MB695 1968	404.99 pr
Center Armrest		
MB696 1968	w/o map pocket	81.99 ea
MB697 1968	w/map pocket	81.99 ea
Rear Seat		
MB698 1968	hardtop	284.99 ea
MB699 1968	convertible	284.99 ea



MB689100

Legendary
AUTO RESTORATION LTD.

Made in USA

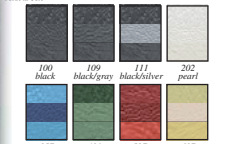

1968 Charger & Charger R/T Upholstery

Ascot grain inserts and Cologne grain pleats with Dorchester grain outers for a factory look and feel. Made in USA.

Note: Please add three digit color code when ordering. *No further discounts apply.

Front Buckets		
MB689 1968	gold w/parch - NOS	654.99 pr
MB689 1968	all other colors	479.99 pr
Center Cushion/Armrest without Map Pocket		
MB690 1968	gold	81.99 ea
MB690 1968	all other colors	81.99 ea
Center Cushion/Armrest with Map Pocket		
MB691 1968	gold	81.99 ea
MB691 1968	all other colors	81.99 ea
Rear Seat		
MB692 1968	gold w/parch - NOS	494.99 ea
MB692 1968	all other colors	331.99 ea



MB716100

Legendary
AUTO RESTORATION LTD.

Made in USA

1968 Charger Cloth/Vinyl Upholstery

Cloth inserts and Coachman grain vinyl outers for a factory look and feel. Fits Charger SE, Charger R/T SE with the CSX option. Made in USA.

Note: *No further discounts apply.

Front Buckets		
MB716100*	1969 black - NOS	704.99 pr
Center Cushion/Armrest without Map Pocket		
MB713100	1969 black	81.99 ea
Center Cushion/Armrest with Map Pocket		
MB714100	1969 black	81.99 ea
Rear Seat		
MB717100*	1969 black - NOS	562.99 ea

Legendary
AUTO RESTORATION LTD.

Made in USA



MB712650

Made in USA

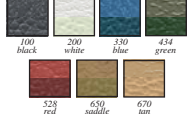

1968 Charger Vinyl Upholstery

Ascot grain inserts and Coachman grain outers for a factory look and feel. Fits Charger, Charger 500, Charger R/T and Daytona. Made in USA.

Note: *Dukes of Hazzard tan is a pre-paid, non-returnable special order only.

Front Buckets		
MB712*	1969 Dukes of Hazzard tan	435.99 pr
MB712	1969 all other colors	404.99 pr
Center Cushion/Armrest without Map Pocket		
MB713*	1969 Dukes of Hazzard tan	81.99 ea
MB713	1969 all other colors	81.99 ea
Center Cushion/Armrest with Map Pocket		
MB714*	1969 Dukes of Hazzard tan	81.99 ea
MB714	1969 all other colors	81.99 ea
Rear Seat		
MB715*	1969 Dukes of Hazzard tan	284.99 ea
MB715	1969 all other colors	284.99 ea



Legendary
AUTO RESTORATION LTD.

Made in USA

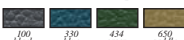

1968 Charger Leather Upholstery

Leather inserts and Coachman grain vinyl outers for a factory look and feel. Fits Charger SE, Charger R/T SE. Please add the three digit color code suffix to the part number when ordering. Made in USA.

Important: Rear seat is available in Coachman grain vinyl only. Note: Please add three digit color code when ordering. *No further discounts apply.

Front Buckets		
MB718*	1969 black - NOS	774.99 pr
MB718*	1969 all other colors - NOS	1135.99 pr
Center Cushion/Armrest without Map Pocket		
MB713	1969 all colors	81.99 ea
Center Cushion/Armrest with Map Pocket		
MB714	1969 all colors	81.99 ea
Rear Seat Vinyl Only		
MB719	1969 all colors	284.99 ea

Legendary
AUTO RESTORATION LTD.

Made in USA



MB722100

Made in USA

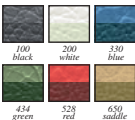

1968 Coronet & Super Bee Upholstery

El Paso grain inserts and Coachman grain outers for a factory look and feel. Fits 1969 Coronet 500, Coronet R/T & Super Bee. Made in USA.

Important: Metal emblems are not included.

Note: Please add three digit color code when ordering.

Front Buckets		
MB722	1969	404.99 pr
Center Armrest		
MB713	1969 w/o map pocket	81.99 ea
MB714	1969 w/map pocket	81.99 ea
Rear Seat		
MB723	1969 hardtop	284.99 ea
MB724	1969 convertible	284.99 ea

INTERIOR COMPONENTS

Bucket Seat Upholstery

— PLYMOUTH B-BODY • 1968-69 —



MB707683



Made in USA



1968 Sport Satellite & GTX Vinyl Upholstery

Crush grain inserts and Cologne grain outers for a factory look and feel. Made in USA. *Note: Metal emblems are not included.*

Front Buckets	
MB707100	1968 black..... 479.99 pr
MB707120	1968 gold/black w/black accent & black welt..... 479.99 pr
MB707121	1968 gold/black w/black accent & gold welt..... 479.99 pr
MB707122	1968 gold/gold w/black accent & gold welt..... 479.99 pr
MB707202	1968 pearl white..... 479.99 pr
MB707332	1968 blue..... 479.99 pr
MB707433	1968 green..... 479.99 pr
MB707526	1968 maroon..... 479.99 pr
MB707683	1968 black/gold w/gold accent & black welt..... 479.99 pr
MB707684	1968 black/gold w/gold accent & gold welt..... 479.99 pr
Center Cushion/Armrest without Map Pocket	
MB708100	1968 black..... 81.99 ea
MB708120	1968 gold/black w/black accent & black welt..... 81.99 ea
MB708121	1968 gold/black w/black accent & gold welt..... 81.99 ea
MB708122	1968 gold/gold w/black accent & gold welt..... 81.99 ea
MB708202	1968 pearl white..... 81.99 ea
MB708332	1968 blue..... 81.99 ea
MB708433	1968 green..... 81.99 ea
MB708526	1968 maroon..... 81.99 ea
MB708683	1968 black/gold w/gold accent & black welt..... 81.99 ea
MB708684	1968 black/gold w/gold accent & gold welt..... 81.99 ea
Center Cushion/Armrest with Map Pocket	
MB709100	1968 black..... 81.99 ea
MB709120	1968 gold/black w/black accent & black welt..... 81.99 ea
MB709121	1968 gold/black w/black accent & gold welt..... 81.99 ea
MB709122	1968 gold/gold w/black accent & gold welt..... 81.99 ea
MB709202	1968 pearl white..... 81.99 ea
MB709332	1968 blue..... 81.99 ea
MB709433	1968 green..... 81.99 ea
MB709526	1968 maroon..... 81.99 ea
MB709683	1968 black/gold w/gold accent & black welt..... 81.99 ea
MB709684	1968 black/gold w/gold accent & gold welt..... 81.99 ea

Hardtop Rear Seat	
MB710100	1968 black..... 331.99 ea
MB710120	1968 gold/black w/black accent & black welt..... 331.99 ea
MB710121	1968 gold/black w/black accent & gold welt..... 331.99 ea
MB710122	1968 gold/gold w/black accent & gold welt..... 331.99 ea
MB712022	1968 pearl white..... 331.99 ea
MB710332	1968 blue..... 331.99 ea
MB710433	1968 green..... 331.99 ea
MB710526	1968 maroon..... 331.99 ea
MB710683	1968 black/gold w/gold accent & black welt..... 331.99 ea
MB710684	1968 black/gold w/gold accent & gold welt..... 331.99 ea

Convertible Rear Seat	
MB711100	1968 black..... 331.99 ea
MB711120	1968 gold/black w/black accent & black welt..... 331.99 ea
MB711121	1968 gold/black w/black accent & gold welt..... 331.99 ea
MB711122	1968 gold/gold w/black accent & gold welt..... 331.99 ea
MB711202	1968 pearl white..... 331.99 ea
MB711332	1968 blue..... 331.99 ea
MB711433	1968 green..... 331.99 ea
MB711526	1968 maroon..... 331.99 ea
MB711683	1968 black/gold w/gold accent & black welt..... 331.99 ea
MB711684	1968 black/gold w/gold accent & gold welt..... 331.99 ea



MOORE INTERIORS CO.

Heavy Foam Backing As Original

Using quality materials is essential when replacing your interior. Although many manufacturers neglect this area, we insist on offering OEM-quality upholstery which features correct high density foam backing stitched into place as original. Once installed, you'll feel the difference!

The Details Matter

From the welting to the correct factory stitching pattern, careful attention is paid to every detail of the original upholstery.



MB732330



Made in USA

Correct Grains and Colors

Each style and color is specifically produced to match the original in weight and grain. You'll get the factory-fresh appearance you want while maintaining the authenticity of your interior.

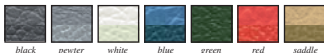

1968 Sport Satellite, Road Runner & GTX Vinyl Upholstery

El Paso grain inserts and Coachman grain outers for a factory look and feel. Made in USA. *Note: Metal emblems are not included.*

Front Buckets	
MB732100	1969 black..... 404.99 pr
MB732130	1969 pewter..... 404.99 pr
MB732200	1969 white..... 404.99 pr
MB732300	1969 blue..... 404.99 pr
MB732434	1969 green..... 404.99 pr
MB732528	1969 red..... 404.99 pr
MB732650	1969 saddle..... 404.99 pr
Center Cushion/Armrest without Map Pocket	
MB713100	1969 black..... 81.99 ea
MB713130	1969 pewter..... 81.99 ea
MB713200	1969 white..... 81.99 ea
MB713300	1969 blue..... 81.99 ea
MB713430	1969 green..... 81.99 ea
MB713528	1969 red..... 81.99 ea
MB713650	1969 saddle..... 81.99 ea
Center Cushion/Armrest with Map Pocket	
MB714100	1969 black..... 81.99 ea
MB714130	1969 pewter..... 81.99 ea
MB714200	1969 white..... 81.99 ea
MB714330	1969 blue..... 81.99 ea
MB714434	1969 green..... 81.99 ea
MB714528	1969 red..... 81.99 ea
MB714650	1969 saddle..... 81.99 ea
Hardtop Rear Seat	
MB733100	1969 black..... 276.99 ea
MB733130	1969 pewter..... 276.99 ea
MB733200	1969 white..... 276.99 ea
MB733300	1969 blue..... 276.99 ea
MB733434	1969 green..... 276.99 ea
MB733528	1969 red..... 276.99 ea
MB733650	1969 saddle..... 276.99 ea
Convertible Rear Seat	
MB734100	1969 black..... 276.99 ea
MB734130	1969 pewter..... 276.99 ea
MB734200	1969 white..... 276.99 ea
MB734330	1969 blue..... 276.99 ea
MB734434	1969 green..... 276.99 ea
MB734528	1969 red..... 276.99 ea
MB734650	1969 saddle..... 276.99 ea

Bucket Seat Upholstery

— DODGE B-BODY · 1970 —



handmade
MADE IN CANADA U.S.A.

MB737540



Made in USA

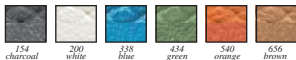

1970 Charger Bucketweave Vinyl Upholstery

Diamond Basketweave grain inserts and Krinkle grain outers for a factory look and feel. Fits 1970 Charger, Charger 500, Charger R/T. Made in USA.
Note: Please add three digit color code when ordering.

MB737	1970	front buckets	479.99	pr
MB738	1970	center armrest without map pocket	81.99	ea
MB739	1970	center armrest with map pocket	81.99	ea
MB740	1970	rear seat	316.99	ea

handmade
MADE IN CANADA U.S.A.



MB741813



Made in USA



charcoal

1970 Charger Cloth/Vinyl Upholstery

Cloth inserts and Krinkle grain vinyl outers for a factory look and feel. Fits 1970 Charger, Charger 500, Charger R/T. Made in USA.
Note: No further discounts apply.

MB741813*	1970	black & white cloth/charcoal	766.99	pr
Center Cushion/Armrest without Map Pocket				
MB738154	1970	charcoal	81.99	ea
Center Cushion/Armrest with Map Pocket				
MB739154	1970	charcoal	81.99	ea
Rear Seat				
MB742813*	1970	black & white/charcoal	574.99	ea

New!



handmade
MADE IN CANADA U.S.A.

MB743154



Made in USA

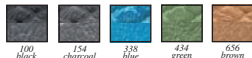

100 black, 154 charcoal, 338 blue, 434 green, 656 brown

1970 Charger Bucketweave Leather Upholstery

Diamond Basketweave leather inserts with leather collars and Krinkle grain vinyl outers for a factory look and feel. Fits 1970 Charger 500, Charger R/T. Made in USA.
Important: Rear seat is available in Krinkle grain vinyl only.

Note: Please add three digit color code when ordering.				
<i>*No further discounts apply.</i>				
MB743*	1970	front buckets - black leather	1082.99	pr
MB743*	1970	front buckets - all other colors in leather	1489.99	pr
MB738	1970	center armrest without map pocket	81.99	ea
MB739	1970	center armrest with map pocket	81.99	ea
MB740	1970	rear seat all vinyl construction	316.99	ea



Made in USA



handmade
MADE IN CANADA U.S.A.

MB747540

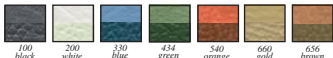

100 black, 200 white, 330 blue, 434 green, 540 orange, 660 gold, 656 brown

1970 Coronet, Super Bee Vinyl Upholstery

Shallow Elk grain inserts and Coachman grain outers for a factory look and feel. Fits 1970 Coronet 500, Coronet R/T & Super Bee. Made in USA.

Note: Please add three digit color code when ordering.				
<i>*No further discounts apply.</i>				

Front Buckets				
MB747*	1970	gold - NOS	945.99	pr
MB747	1970	all other colors	404.99	pr
Center Cushion/Arm Rest without Map Pocket				
MB713*	1970	gold - NOS	184.99	ea
MB713	1970	all other colors	81.99	ea
Center Cushion/Arm Rest with Map Pocket				
MB714*	1970	gold - NOS	184.99	ea
MB714	1970	all other colors	81.99	ea
Hardtop Rear Seat				
MB748*	1970	gold - NOS	814.99	ea
MB748	1970	all other colors	276.99	ea
Convertible Rear Seat				
MB749*	1970	gold - NOS	814.99	ea
MB749	1970	all other colors	276.99	ea



Bucket Seat Upholstery

— PLYMOUTH B-BODY • 1970 —

Heavy Foam Backing As Original

Using quality materials is essential when replacing your interior. Although many manufacturers neglect this area, we insist on offering OEM-quality upholstery which features correct high density foam backing stitched into place as original. Once installed, you'll feel the difference!

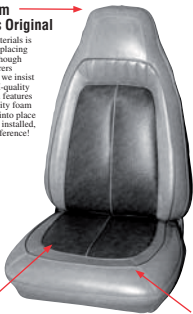

Legendary
AUTO UPHOLSTERY

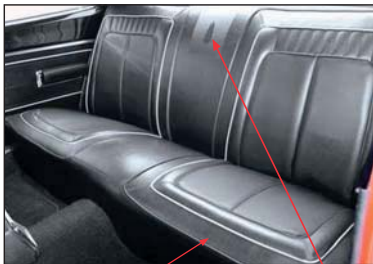

Correct Manufacturing Techniques

Each upholstery set is professionally reproduced using exact factory specifications. Correct manufacturing techniques allow the restorer to get a factory appearance with easier installation.

Correct Grains and Colors

Each style and color is specifically produced to match the original upholstery in weight and grain. You'll get the factory-fresh appearance you want while maintaining the authenticity of your interior.

The Details Matter

When it comes to details, the word is *Legendary!* Right down to the heat-sealed Plymouth emblem which features the correct original factory grain and texture.

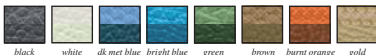

1970 Sport Satellite, Road Runner, GTX & Superbird Upholstery

Ranger grain inserts and Coachman grain outers for a factory look and feel. Features Plymouth emblem heat sealed onto the center of rear seat. Made in USA.

*Note: *No further discounts apply.*

Front Buckets

MB755100	1970	black	421.99	pr
MB755115	1970	black with silver welt	421.99	pr
MB755157	1970	black/charcoal with black welt	421.99	pr
MB755159	1970	black/charcoal with silver welt	421.99	pr
MB755200	1970	white	421.99	pr
MB755300	1970	dark metallic blue	421.99	pr
MB755363	1970	bright blue with white welt	421.99	pr
MB755434	1970	dark metallic green with dk met green welt	421.99	pr
MB755439	1970	dark metallic green with light met green welt	421.99	pr
MB755659	1970	brown with brown welt	421.99	pr
MB755543	1970	burnt orange with bright orange welt	421.99	pr
MB755669*	1970	gold w/black welt - NOS	961.99	pr

Center Cushion/Arm Rest without Map Pocket

MB713100	1970	black	81.99	ea
MB713154	1970	charcoal	81.99	ea
MB713200	1970	white	81.99	ea
MB713330	1970	dark metallic blue	81.99	ea
MB713338	1970	bright blue	81.99	ea
MB713434	1970	dark metallic green	81.99	ea
MB713540	1970	burnt orange	81.99	ea
MB713656	1970	brown	81.99	ea
MB713660*	1970	gold - NOS	184.99	ea

Center Cushion/Arm Rest with Map Pocket

MB714100	1970	black	81.99	ea
MB714154	1970	charcoal	81.99	ea
MB714200	1970	white	81.99	ea
MB714330	1970	dark metallic blue	81.99	ea
MB714338	1970	bright blue	81.99	ea
MB714434	1970	dark metallic green	81.99	ea
MB714540	1970	burnt orange	81.99	ea

Center Cushion/Armrest with Map Pocket - Continued

MB714656	1970	brown	81.99	ea
MB714660*	1970	gold - NOS	184.99	ea

Hardtop Rear Seat

MB756100	1970	black	354.99	ea
MB756115	1970	black with silver welt	354.99	ea
MB756157	1970	black/charcoal with black welt	354.99	ea
MB756159	1970	black/charcoal with silver welt	354.99	ea
MB756200	1970	white	354.99	ea
MB756330	1970	dark metallic blue	354.99	ea
MB756363	1970	bright blue with white welt	354.99	ea
MB756434	1970	dark met green with dark met green welt	354.99	ea
MB756439	1970	dark met green with light met green welt	354.99	ea
MB756659	1970	brown with brown welt	354.99	ea
MB756543	1970	burnt orange with bright orange welt	354.99	ea
MB756669*	1970	gold w/black welt - NOS	811.99	ea

Convertible Rear Seat

MB757100	1970	black	354.99	ea
MB757115	1970	black with silver welt	354.99	ea
MB757157	1970	black/charcoal with black welt	354.99	ea
MB757159	1970	black/charcoal with silver welt	354.99	ea
MB757200	1970	white	354.99	ea
MB757330	1970	dark metallic blue	354.99	ea
MB757363	1970	bright blue with white welt	354.99	ea
MB757434	1970	dark met green with dark met green welt	354.99	ea
MB757439	1970	dark met green with light met green welt	354.99	ea
MB757659	1970	brown with brown welt	354.99	ea
MB757543	1970	burnt orange with bright orange welt	354.99	ea

Bucket Seat Upholstery

— DODGE & PLYMOUTH B-BODY • 1971 —



Heavy Foam Backing As Original

Using quality materials is essential when restoring an interior. Although many manufacturers neglect this area, we insist on offering OEM-quality upholstery which features correct high density foam backing stitched into place as original. Once installed, you'll feel the difference!

USA
MADE IN AMERICA



Made in USA

Correct Grains and Colors

Each style and color is specifically produced to match the original upholstery in weight and grain. You'll get the factory-fresh appearance you want while maintaining the authenticity of your interior.

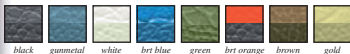

1971 Charger, GTX, Road Runner, Satellite, Super Bee Upholstery

El Paso grain inserts and Coachman grain outers for a factory look and feel. Fits 1971 Charger 500, Charger R/T, Super Bee, Satellite Sebring Plus, Road Runner & GTX. Made in USA.

Front Buckets

MB774100	1971	black	404.99	pr
MB774140	1971	gunmetal	404.99	pr
MB774200	1971	white	404.99	pr
MB774340	1971	bright blue	404.99	pr
MB774452	1971	dark metallic green	404.99	pr
MB774561	1971	bright orange	404.99	pr
MB774664	1971	brown	404.99	pr
MB774666	1971	ember gold	404.99	pr

Center Cushion/Armrest

MB766100	1971	black	81.99	ea
MB766140	1971	gunmetal	81.99	ea
MB766200	1971	white	81.99	ea
MB766340	1971	bright blue	81.99	ea
MB766452	1971	dark metallic green	81.99	ea
MB766561	1971	bright orange	81.99	ea
MB766664	1971	brown	81.99	ea
MB766666	1971	ember gold	81.99	ea

Rear Seat

MB775100	1971	black	332.99	ea
MB775140	1971	gunmetal	332.99	ea
MB775200	1971	white	332.99	ea
MB775340	1971	bright blue	332.99	ea
MB775452	1971	dark metallic green	332.99	ea
MB775561	1971	bright orange	332.99	ea
MB775664	1971	brown	332.99	ea
MB775666	1971	ember gold	332.99	ea



USA
MADE IN AMERICA

MB768845

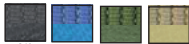

Made in USA

1971 Charger SE Cloth/Vinyl Upholstery

Ribbed cloth inserts and Belmont grain vinyl outers for a factory look and feel. Made in USA.

Note: Please add three digit color code when ordering. No further discounts apply.

MB768	1971	front buckets - NOS	744.99	pr
MB563	1971	rear seat - NOS	597.99	ea

USA
MADE IN AMERICA

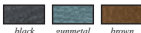

Made in USA

1971 Charger SE Leather Upholstery

Leather inserts with buttons and Belmont grain vinyl outers for a factory look and feel. Made in USA.

Note: Please add three digit color code when ordering. No further discounts apply.

MB770100*	1971	black	851.99	pr
MB770140*	1971	gunmetal	1135.99	pr
MB770664*	1971	brown	1135.99	pr

Rear Seat Vinyl Only

MB771100	1971	black	276.99	ea
MB771140	1971	gunmetal	276.99	ea
MB771664	1971	brown	276.99	ea

USA
MADE IN AMERICA



USA
MADE IN AMERICA

MB765811



Made in USA

1971 Dodge & Plymouth B-Body Cloth Upholstery

Salt & Pepper cloth inserts and Coachman grain vinyl outers for a factory look and feel. Fits 1971 Charger 500, Charger R/T, GTX, Road Runner, Satellite and Super Bee. Made in USA.

Note: Please add three digit color code when ordering. No further discounts apply.

Front Buckets

MB765*	1971	black	1014.99	pr
MB765*	1971	all other colors	985.99	pr

Center Cushion/Arm Rest

MB766	1971	center cushion/arm rest	81.99	ea
-------	------	-------------------------	-------	----

Rear Seat

MB767*	1971	black	894.99	ea
MB767*	1971	all other colors	867.99	ea

USA
MADE IN AMERICA

A INTERIOR COMPONENTS

Bucket Seat Upholstery

— DODGE & PLYMOUTH B-BODY • 1972-74 —



MB776100



100 black 200 white 340 hot blue 444 green 666 gold

1972 Satellite, Road Runner & GTX Upholstery

Shallow Elk grain inserts and Coachman grain outers for a factory look and feel. Fits 1972 Satellite Sebring Plus, Road Runner & GTX. Please add the three digit color code suffix to the part number when ordering. Made in USA.

Note: Please add three digit color code when ordering.
MB776 1972 front buckets..... 404.99 pr
MB766 1972 ctr cushion/armrest 81.99 ea
MB777 1972 rear seat..... 332.99 ea



MB798811



black

1973 Charger & Charger SE Cloth Upholstery

Salt & Pepper cloth seat inserts with buttons and your choice of black Coachman or Cologne grain vinyl outers for a factory look and feel. Made in USA.

Note: *No further discounts apply.

Coachman Grain Outers

MB798811* 1973 front buckets..... 731.99 pr
MB766100 1973 ctr cushion/arm rest. 81.99 ea
MB740811* 1973 rear seat..... 615.99 pr

Cologne Grain Outers

MB798811* 1973 front buckets..... 731.99 pr
MB789100 1973 ctr cushion/arm rest 81.99 ea
MB741811* 1973 rear seat..... 615.99 pr



MB788449

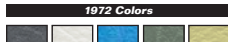

100 black 200 white 340 bright blue 444 green 666 gold

1972 Colors



100 black 200 white 253 parchment

1973 Colors



352 blue 449 met green 673 bronze/gold

1972-73 Charger, Satellite, Road Runner

Hand-crafted upholstery made with Shallow Elk grain inserts and your choice of Coachman or Cologne grain outers for a factory look and feel. Includes buttons on the seat inserts as original. Fits 1972-73 Charger, Charger SE, Satellite Sebring Plus and Road Runner. Made in USA.

Note: Special order, must be pre-paid. Please add three digit color code when ordering. *No further discounts apply.

Coachman Grain Outer

Front Buckets
MB786* 1973 parchment - NOS..... 669.99 pr
MB786* 1973 met green - NOS..... 669.99 pr
MB786* 1973 met bronze/gld - NOS 669.99 pr
MB786 1972-73 all other colors..... 404.99 pr

Center Cushion/Armrest

MB766 1972-73 all colors..... 81.99 ea

Rear Seat

MB787* 1973 parchment - NOS..... 546.99 ea
MB787* 1973 met green - NOS..... 546.99 ea
MB787* 1973 met bronze/gld - NOS 546.99 ea
MB787 1972-73 all other colors..... 276.99 ea

Cologne Grain Outer

Front Buckets
MB788* 1973 parchment - NOS..... 669.99 pr
MB788* 1973 met green - NOS..... 669.99 pr
MB788* 1973 met bronze/gld - NOS 669.99 pr
MB788 1972-73 all other colors..... 404.99 pr

Center Cushion/Armrest

MB789 1972-73 all colors..... 81.99 ea

Rear Seat

MB790* 1973 parchment - NOS..... 546.99 ea
MB790* 1973 met green - NOS..... 546.99 ea
MB790* 1973 met bronze/gld - NOS 546.99 ea
MB790 1972-73 all other colors..... 276.99 pr



MB812360



100 black 200 white 360 blue 450 green 680 gold

1974 Charger, Charger SE Upholstery

Shallow Elk grain inserts with buttons and Oxford grain outers for a factory look and feel. Fits 1974 Charger, Charger SE. Made in USA.

Note: Please add three digit color code when ordering. *No further discounts apply.

Front Buckets

MB812* 1974 gold - NOS..... 945.99 pr

MB812 1974 all other colors..... 404.99 pr

Center Cushion/Armrest

MB813 1974 gold..... 184.99 ea

MB813 1974 all other colors..... 81.99 ea

Rear Seat

MB814* 1974 gold - NOS..... 814.99 ea

MB814 1974 all other colors..... 276.99 ea



MB806951



1974 Charger & Charger SE Cloth Upholstery

Aztec cloth inserts with buttons and Oxford grain vinyl outers for a factory look and feel. Made in USA.

Note: *No further discounts apply.

Front Buckets

MB806951* 1974 Aztec cloth - NOS.. 741.99 pr

Center Cushion/Armrest

MB807200 1974 white vinyl..... 81.99 ea

Rear Seat

MB808951* 1974 Aztec cloth - NOS.. 597.99 ea



1974 Satellite & Road Runner Cloth Upholstery

Wimbledon cloth inserts with buttons and Oxford grain vinyl outers for a factory look and feel. Fits 1974 Satellite Sebring Plus & Road Runner. Made in USA.

Note: *No further discounts apply on NOS material.

Front Buckets

MB90941* 1974 Wimbledon cloth..... 741.99 pr

Center Cushion/Armrest

MB807200 1974 white vinyl..... 81.99 ea

Rear Seat

MB901941* 1974 Wimbledon cloth..... 597.99 ea

Bucket Seat Upholstery

— DODGE & PLYMOUTH E-BODY • 1970-71 —



Made in USA **ME70100** *Sealed*
MADE IN AMERICA USA

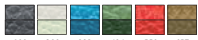

1970 Barracuda & 'Cuda Upholstery

Ranger grain inserts and Coachman grain outers for a factory look and feel. Made in USA.

Note: Please add three digit color code when ordering.
ME701 1970 front buckets..... 421.99 pr
ME702 1970 hardtop rear seat..... 284.99 ea
ME703 1970 convertible rear seat... 284.99 ea



Made in USA **ME714100** *Sealed*
MADE IN AMERICA USA

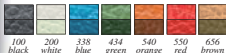

1970 Challenger, R/T & SE Regal Grain

Regal grain inserts and Coachman grain outers for a factory look and feel. Made in USA.

Note: Please add three digit color code when ordering.
ME714 1970 front buckets..... 421.99 pr
ME715 1970 hardtop rear seat..... 284.99 ea
ME716 1970 convertible rear seat... 284.99 ea

Made in USA *Sealed*
MADE IN AMERICA USA

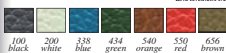

1970 Challenger, R/T & SE Coachman Grain

Coachman grain inserts and Coachman grain outers for a factory look and feel. Fits 1970 Challenger R/T and SE models. Made in USA.

Note: Please add three digit color code when ordering.
ME717 1970 front buckets..... 421.99 pr
ME718 1970 hardtop rear seat..... 284.99 ea
ME719 1970 convertible rear seat... 284.99 ea



Made in USA **ME705154** *Sealed*
MADE IN AMERICA USA

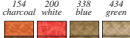
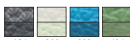

1970 Barracuda Gran Coupe Upholstery

Heat sealed Shallow Elk grain inserts and accent belts with Ranger grain inset panel and Coachman grain outers for a factory look and feel. Made in USA.

Important: Metal emblems not included.
Note: Please add three digit color code when ordering.
**No further discounts apply.*

Front Buckets
ME705* 1970 gold - NOS..... 836.99 pr
ME705 1970 all other colors..... 435.99 pr
Hardtop Rear Seat
ME706* 1970 gold - NOS..... 771.99 ea
ME706 1970 all other colors..... 299.99 ea
Convertible Rear Seat
ME707* 1970 gold - NOS..... 771.99 ea
ME707 1970 all other colors..... 299.99 ea



Made in USA **ME728560** *Sealed*
MADE IN AMERICA USA



1971 Barracuda, Challenger Std Upholstery

El Paso grain inserts and Coachman grain outers for a factory look and feel. Fits 1971 Barracuda, 'Cuda, Challenger. Made in USA.

Important: Front bucket seat upholstery is available with or without cord welting surrounding the seat insert.
Note: Please add three digit color code when ordering.

Front Buckets
ME728 1971 w/o insert welting..... 391.99 pr
ME729 1971 w/insert welting..... 391.99 pr
Rear Seats
ME730 1971 hardtop..... 284.99 ea
ME731 1971 convertible..... 284.99 ea



Made in USA **ME708791** *Sealed*
MADE IN AMERICA USA
black orange

1970 Barracuda Gran Coupe Cloth Upholstery

Houndstooth cloth inserts with Coachman grain vinyl outers for a factory look and feel. Features the correctly colored insert welting. Made in USA.

Note: No further discounts apply.

Front Buckets
ME708791 1970 black - NOS..... 727.99 pr
ME708793 1970 orange - NOS..... 727.99 pr
Hardtop Rear Seat
ME709791 1970 black - NOS..... 477.99 ea
ME709793 1970 orange - NOS..... 477.99 ea



Made in USA **ME726817** *Sealed*
MADE IN AMERICA USA
black orange

1971 Barracuda, 'Cuda & Gran Coupe Cloth

Salt & Pepper cloth inserts and Coachman grain vinyl outers for a factory look and feel. Made in USA.

Note: Rear seat upholstery not available for convertible. No further discounts apply.

Front Buckets with Cloth Headrest Insert
ME725816 1971 black - NOS..... 762.99 pr
ME725817 1971 orange - NOS..... 762.99 pr
Front Buckets with Vinyl Headrest Insert
ME726816 1971 black - NOS..... 762.99 pr
ME726817 1971 orange - NOS..... 762.99 pr
Hardtop Rear Seat
ME727816 1971 black - NOS..... 607.99 ea
ME727817 1971 orange - NOS..... 607.99 ea

A INTERIOR COMPONENTS

Bucket Seat Upholstery

— DODGE & PLYMOUTH E-BODY • 1970-74 —



Made in USA

ME711200

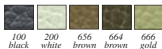

100 black 200 white 656 brown 664 brown 666 gold

1970-71 'Cuda & Gran Coupe Leather

Leather inserts and collars with Coachman grain outers for a factory look and feel. NOS material. Made in USA.

Note: Please add three digit color code when ordering. No further discounts apply.

Front Buckets

ME711 1970-71 black 887.99 pr
ME711 1970-71 all other colors..... 1151.99 pr

Hardtop Rear Seat Vinyl Only

ME712 1970-71 all colors 284.99 ea

Convertible Rear Seat Vinyl Only

ME713 1970-71 all colors 284.99 ea

Leather
AUTO INTERIOR LTD.

ASSURANTE
SYSTEM



Made in USA

ME722811

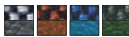

811 black 815 orange 819 blue 823 green

1970 Challenger Cloth Upholstery

Salt & Pepper cloth inserts with Coachman grain vinyl outers. Fits 1970 Challenger, R/T and SE. Made in USA.

Note: Please add three digit color code when ordering. No further discounts apply.

Front Bucket Seats

ME725 1970 black 666.99 pr
ME722 1970 all other colors - NOS 647.99 pr

Hardtop Rear Seat

ME725 1970 black 492.99 ea
ME723 1970 all other colors - NOS 477.99 ea

ASSURANTE
SYSTEM

Made in USA



100 black 200 white 340 blue 452 green 664 brown 666 gold

1971 Challenger R/T Deluxe Upholstery

Belmont grain inserts and Coachman grain outers. Add the three digit color code to the part number when ordering. Made in USA.

Note: Please add three digit color code when ordering.

ME750 1971 front buckets 421.99 pr
ME751 1971 hardtop rear seat 284.99 ea
ME752 1971 convertible rear seat..... 284.99 ea

Made in USA



black burnt orange brown

1970-71 Challenger Leather Upholstery

Leather inserts and collars with Coachman grain vinyl outers. Fits 1970-71 Challenger, R/T and SE. Made in USA.

Important: Rear seat upholstery has the leather style cut and pattern to match the front, but is manufactured in vinyl. Note: *No further discounts apply.

Front Buckets Leather

ME740100* 1970 black 1101.99 pr
ME740540* 1970 burnt orange 1426.99 pr
ME740656* 1970 brown 1426.99 pr
ME740100* 1971 black 1101.99 pr

Hardtop Rear Seat Vinyl

ME741100 1970 black 284.99 ea
ME741540 1970 burnt orange 284.99 ea
ME741656 1970 brown 284.99 ea
ME742100 1971 black 284.99 ea

Convertible Rear Seat Vinyl

ME743100 1970 black 284.99 ea
ME743540 1970 burnt orange 284.99 ea
ME743656 1970 brown 284.99 ea
ME744100 1971 black 284.99 ea

ASSURANTE
SYSTEM

Made in USA



831 black 833 green 835 orange/red

1971 Challenger Cloth Upholstery

Plaid cloth inserts and Coachman grain vinyl outers for a factory look and feel. Fits 1971 Challenger and Challenger R/T. NOS material. Made in USA.

Note: No further discounts apply.

Front Buckets

ME745831 black w/white cloth 711.99 pr
ME745833 dark green w/green cloth 711.99 pr
ME745835 black w/orange/red cloth 711.99 pr

Hardtop Rear Seat

ME746831 black w/white cloth 477.99 ea
ME746833 dark green w/green cloth 477.99 ea
ME746835 black w/orange/red cloth 477.99 ea

Leather
AUTO INTERIOR LTD.

ASSURANTE
SYSTEM



Made in USA

ME734100



100 black 200 white 340 blue 444 green 666 gold

1972 Barracuda, 'Cuda, Challenger Upholstery

Ranger grain inserts and Coachman grain outers for a factory look and feel. Made in USA.

Note: Please add three digit color code when ordering.

ME734 1972 front buckets 421.99 pr
ME735 1972 hardtop rear seat 284.99 ea

Leather
AUTO INTERIOR LTD.



Made in USA

ME736355



100 black 200 white 355 dk blue 447 green

1973 Barracuda, 'Cuda, Challenger Upholstery

Empire grain inserts and Coachman grain outers for a factory look and feel. Made in USA.

Note: Please add three digit color code when ordering.

ME736 1973 front buckets 421.99 pr
ME737 1973 hardtop rear seat 284.99 ea

Made in USA



100 black 200 white 360 blue 450 green

1974 Barracuda, 'Cuda, Challenger Upholstery

Empire grain inserts with Oxford grain outers for a factory look and feel. Made in USA.

Note: Please add three digit color code when ordering.

ME738 1974 front buckets 421.99 pr
ME739 1974 rear seat 284.99 ea

Leather
AUTO INTERIOR LTD.

Bench Seat Upholstery

— DODGE A-BODY • 1966-68 DART —



MA618532



MA618151

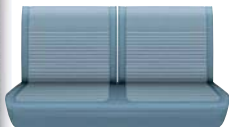

MA618327

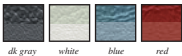

1966 Dart 270 Upholstery

Cirrus grain inserts and Cologne grain outers for a factory look and feel. Made in USA.

MA618151	1966	dark gray	404.99 ea
MA618211	1966	white	404.99 ea
MA618327	1966	blue	404.99 ea
MA618532	1966	red	404.99 ea

Hardtop Rear Seat			
MA656151	1966	dark gray	284.99 ea
MA656211	1966	white	284.99 ea
MA656327	1966	blue	284.99 ea
MA656532	1966	red	284.99 ea

Convertible Rear Seat			
MA619151	1966	dark gray	284.99 ea
MA619211	1966	white	284.99 ea
MA619327	1966	blue	284.99 ea
MA619532	1966	red	284.99 ea



MA655327

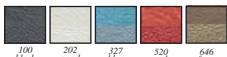

1967 Dart 270 Upholstery

Dorchester grain inserts and Cologne grain outers for a factory look and feel. Made in USA.

Note: Please add three digit color code when ordering.

**No further discounts apply.*

Front Split Bench

MA635*	1967	fawn - NOS	867.99 ea
MA635	1967	all other colors	404.99 ea

Hardtop Rear Seat

MA636*	1967	fawn - NOS	737.99 ea
MA636	1967	all other colors	284.99 ea



MA633520

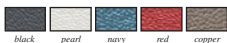

1967 Dart GT Seat Upholstery

Heat sealed Cologne grain inserts and outers for a factory look and feel. Features factory style stitching pattern and correct high density foam backing stitched into place as original. Emblems not included. Made in USA.

Convertible Front Split Bench

MA633100	1967	black	404.99 ea
MA633202	1967	pearl	404.99 ea
MA633320	1967	navy	404.99 ea
MA633520	1967	red	404.99 ea
MA633620	1967	copper	404.99 ea

Convertible Rear Seat

MA632100	1967	black	276.99 ea
MA632202	1967	pearl	276.99 ea
MA632320	1967	navy	276.99 ea
MA632520	1967	red	276.99 ea
MA632620	1967	copper	276.99 ea



MB651357

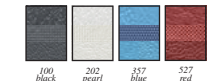

1968 Dart GT & Dart GTS Upholstery

Ascot grain inserts with KV grain pleat and Cologne grain outers for a factory look and feel. Made in USA.

Important: Metal emblems are not included.

Note: Please add three digit color code when ordering.

MA651	1968	conv. front split bench	478.99 ea
MB500	1968	headrest covers	81.99 pr
MA650	1968	convertible rear seat	331.99 ea



MA652359

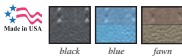

1968 Dart Split Bench Upholstery

Double Stitch Rib grain inserts and Cologne grain outers for a factory look and feel. Optional headrest covers with zipper, as original, available separately. Made in USA.

Note: No further discounts apply.

Front Split Bench

MA652100	1968	black	404.99 ea
MA652359	1968	blue	404.99 ea
MA652652*	1968	fawn - NOS	631.99 ea

Headrest Covers

MB500100	1968	black	81.99 pr
MB500332	1968	blue	81.99 pr
MB500634	1968	fawn	81.99 pr

Hardtop Rear Seat

MA653100	1968	black	284.99 ea
----------	------	-------	-----------

2 & 4 Door Sedan Rear Seat

MA654100	1968	black	284.99 ea
MA654359	1968	blue	284.99 ea
MA654652*	1968	fawn - NOS	464.99 ea

Bench Seat Upholstery

— DODGE A-BODY • 1969-70 DART —



MA676650

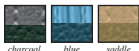

charcoal blue saddle

1969 Dart Swinger, Swinger 340 Upholstery

Double Stitch Rib grain inserts and Coachman grain outers for a factory look and feel. Made in USA.

Front Split Bench

MA676152	1969	charcoal	404.99 ea
MA676351	1969	blue	404.99 ea
MA676650	1969	saddle	404.99 ea

Headrest Covers

MB501152	1969	charcoal	81.99 pr
MB501351	1969	blue	81.99 pr
MB501650	1969	saddle	81.99 pr

Hardtop Rear Seat

MA677152	1969	charcoal	284.99 ea
MA677351	1969	blue	284.99 ea
MA677650	1969	saddle	284.99 ea

2 Door & 4 Door Sedan Rear Seat

MA678152	1969	charcoal	284.99 ea
MA678351	1969	blue	284.99 ea
MA678650	1969	saddle	284.99 ea



MA6669332

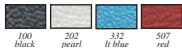

100 black 202 pearl 332 lt blue 507 red

1969 Dart GT & GTs Convertible Split Bench Upholstery

Dakota grain inserts and outers for a factory look and feel. Made in USA.

Note: Please add three digit color code when ordering.

MA669	1969	conv. front split bench	404.99 ea
MB501	1969	headrest covers	81.99 pr
MA668	1969	convertible rear seat	284.99 ea



MA670100

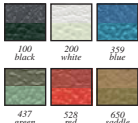

100 black 200 white 359 blue 437 green 528 red 650 saddle

1969 Dart Custom Split Bench Upholstery

Ascot grain inserts and Coachman grain outers for a factory look and feel. Made in USA.

Note: Please add three digit color code when ordering.

MA670	1969	hardtop frt split bench	404.99 ea
MB501	1969	headrest covers	81.99 pr
MA671	1969	hardtop rear seat	284.99 ea



MA672100

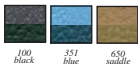

100 black 351 blue 650 saddle

1969 Dart Swinger, Swinger 340 Hardtop Upholstery

Ascot grain inserts and Coachman grain outers for a factory look and feel. Made in USA.

Note: Please add three digit color code when ordering.

MA672	1969	hardtop frt split bench	404.99 ea
MB501	1969	headrest covers	81.99 pr
MA673	1969	hardtop rear seat	284.99 ea



MA705100

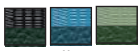

black blue green

1970 Dart, Dart Swinger Upholstery

3/5 Rib grain inserts and Coachman grain outers for a factory look and feel. Fits 1970 Dart, Dart Swinger, Swinger 340. Made in USA.

Front Split Bench

MA705100	1970	black	404.99 ea
MA705351	1970	blue	404.99 ea
MA705435	1970	green	404.99 ea

Hardtop Rear Seat

MA706100	1970	black	284.99 ea
MA706351	1970	blue	284.99 ea
MA706435	1970	green	284.99 ea

4 Door Sedan Rear Seat

MA707100	1970	black	284.99 ea
MA707351	1970	blue	284.99 ea
MA707435	1970	green	284.99 ea



MA703351

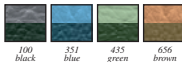

100 black 351 blue 435 green 656 brown

1970 Dart Swinger & Swinger 340 Upholstery

Laredo grain inserts and Coachman grain outers for a factory look and feel. Made in USA.

Note: Please add three digit color code when ordering.

MA703	1970	front split bench	404.99 ea
MA704	1970	hardtop rear seat	284.99 ea

Bench Seat Upholstery

— PLYMOUTH A-BODY • 1967-68 —



MA626100

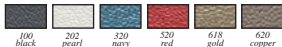

1967 Barracuda Upholstery

Cologne grain inserts and outers for a factory look and feel. Made in USA.

Note: Please add three digit color code when ordering.

**No further discounts apply.*

Front Split Bench with Center Armrest

MA626* 1967 gold - NOS 857.99 ea

MA626 1967 all other colors 399.99 ea

Hardtop Rear Seat

MA627* 1967 gold - NOS 711.99 ea

MA627 1967 all other colors 276.99 ea

Convertible Rear Seat

MA628* 1967 gold - NOS 711.99 ea

MA628 1967 all other colors 276.99 ea

Fastback Rear Seat

MA629* 1967 gold - NOS 711.99 ea

MA629 1967 all other colors 276.99 ea



MA637980



1967 Valiant 200 & Signet Upholstery

Closest lower insert and Cologne grain vinyl top insert with Bambino grain vinyl accent and Cologne grain vinyl outers for a factory look and feel. Made in USA.

Note: Please add three digit color code when ordering.

No further discounts apply.

Sedan Front Split Bench

MA637 1967 brown - NOS 1056.99 ea

MA637 1967 all other colors 741.99 ea

Sedan Rear Seat

MA638 1967 brown - NOS 942.99 ea

MA638 1967 all other colors 597.99 ea



MA643100

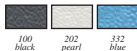

1968 Barracuda Standard Seat Upholstery

Bench seat upholstery for standard models. Cologne grain inserts and outers for a factory look and feel. Made in USA.

Note: Please add three digit color code when ordering.

MA643 1968 front split bench w/armrest 421.99 ea

MA640 1968 hardtop rear seat 284.99 ea

MA641 1968 convertible rear seat 284.99 ea

MA642 1968 fastback rear seat 284.99 ea



MA652359

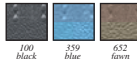

1968 Valiant 100 Upholstery

Double Stitch Rib grain inserts and Cologne grain outers for a factory look and feel. Optional headrest covers with zipper, as original, are available separately. Made in USA.

Note: Please add three digit color code when ordering.

**No further discounts apply.*

Front Split Bench

MA652* 1968 fawn - NOS 631.99 ea

MA652 1968 all other colors 404.99 ea

Headrest Covers

MB500 1968 all colors 81.99 pr

Hardtop Rear Seat

MA653 1968 black 284.99 ea

MA654* 1968 fawn - NOS 464.99 ea

MA654 1968 all other colors 284.99 ea

Bench Seat Upholstery

— PLYMOUTH A-BODY • 1969-70 —



MA676650



charcoal blue saddle

1969 Valiant 100 Upholstery

Bench Seat upholstery for Valiant models, featuring double Stitch Rib grain inserts and Coachman grain outers for a factory look and feel. Made in USA.

Front Split Bench

MA676152	1969	charcoal.....	404.99 ea
MA676351	1969	blue.....	404.99 ea
MA676650	1969	saddle.....	404.99 ea

Headrest Covers

MB501152	1969	charcoal.....	81.99 pr
MB501351	1969	blue.....	81.99 pr
MB501650	1969	saddle.....	81.99 pr

Hardtop Rear Seat

MA677152	1969	charcoal.....	284.99 ea
MA677351	1969	blue.....	284.99 ea
MA677650	1969	saddle.....	284.99 ea

2 Door & 4 Door Sedan Rear Seat

MA678152	1969	charcoal.....	284.99 ea
MA678351	1969	blue.....	284.99 ea
MA678650	1969	saddle.....	284.99 ea



MA674338



100 black 200 white 338 blue

1969 Barracuda Upholstery

Coachman grain inserts and outers for a factory look and feel. Made in USA.

Note: Please add three digit color code when ordering.

MA674	1969	fit split bench w/armrest	421.99 ea
MA657	1969	hardtop rear seat.....	284.99 ea
MA659	1969	fastback rear seat.....	284.99 ea



MA675528



100 black 338 blue 528 red

1969 Barracuda, 'Cuda 340 & 383 Upholstery

Coachman grain inserts and outers for a factory look and feel. Made in USA.

Note: Please add three digit color code when ordering.

MA675	1969	front split bench.....	404.99 ea
MA657	1969	hardtop rear seat.....	284.99 ea
MA659	1969	fastback rear seat.....	284.99 ea



MA705100



black blue green

1970 Duster, Valiant Upholstery

3/5 Rib grain inserts and Coachman grain outers for a factory look and feel. Fits 1970 Valiant and Duster. Made in USA.

Note: Please add three digit color code when ordering.

MA705100	1970	black.....	404.99 ea
MA705351	1970	blue.....	404.99 ea
MA705435	1970	green.....	404.99 ea
MA706100	1970	black.....	284.99 ea
MA706351	1970	blue.....	284.99 ea
MA706435	1970	green.....	284.99 ea
MA707100	1970	black.....	284.99 ea
MA707351	1970	blue.....	284.99 ea
MA707435	1970	green.....	284.99 ea



MA710434



100 black 330 blue 434 green

1970 Duster & Duster 340 Upholstery

Laredo grain inserts and Coachman grain outers for a factory look and feel. Made in USA.

Note: Please add three digit color code when ordering.

MA710	1970	front split bench.....	404.99 ea
MA711	1970	rear seat.....	284.99 ea



MA712550



100 black 152 charcoal 330 blue



434 green 530 red 656 brown

1970 Duster & Duster 340 Upholstery

El Paso grain inserts and Coachman grain outers for a factory look and feel. Made in USA.

Important: Metal emblems are not included.

Note: Please add three digit color code when ordering.

MA712	1970	fit split bench w/armrest	421.99 ea
MA713	1970	rear seat.....	284.99 ea

Bench Seat Upholstery

— DODGE A-BODY • 1971-72 —

Superior
AUTO RESTORATION CO.



MA716666



100 black 200 white 359 blue 442 green 666 gold

1971 Dart Swinger, Dart Custom

Shallow Elk grain inserts and Coachman grain outers for a factory look and feel. Metal emblems are not included. Made in USA.

Note: Please add three digit color code when ordering.

MA716 1971 front split bench 404.99 ea
MA715 1971 hardtop rear seat 284.99 ea

Superior
AUTO RESTORATION CO.



MA705664



100 black 351 blue 451 green 664 brown

1971 Dart 4 Door Sedan Upholstery

3/5 Rib grain inserts and Coachman grain outers for a factory look and feel. Made in USA.

Note: Please add three digit color code when ordering.

MA705 1971 front split bench 404.99 ea
MA707 1971 4 door sedan rear seat... 284.99 ea



100 black 351 blue 664 brown



1971 Demon & Demon 340 Vinyl Upholstery

3/5 Rib grain inserts and Coachman grain outers for a factory look and feel. Made in USA.

Note: Please add three digit color code when ordering.

MA705 1971 front split bench 404.99 ea
MA706 1971 rear seat 284.99 ea

Superior
AUTO RESTORATION CO.



MA720835

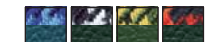

829 blue 831 black 833 green 835 orange

1971 Demon & Demon 340 Cloth Upholstery

Plaid cloth inserts and Coachman grain outers for a factory look and feel. NOS material. Made in USA.

Note: Please add three digit color code when ordering.

No further discounts apply.

MA720 1971 front split bench 725.99 ea
MA721 1971 rear seat 597.99 ea



MA722100



100 black 200 white 340 brt blue 444 green 666 gold

1972 Dart Custom 4 Door Sedan Upholstery

Coachman grain inserts and Cologne grain outers for a factory look and feel. Fits Dart Custom 4 door sedan. Made in USA.

Important: Metal emblems are not included.

Note: Please add three digit color code when ordering.

MA722 1972 split bench w/armrest... 421.99 ea

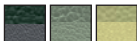

100 black 444 green 666 gold

Superior
AUTO RESTORATION CO.



1972 Demon & Demon 340 Upholstery

Coachman grain inserts and Cologne grain outers for a factory look and feel. Made in USA.

Important: Metal emblems are not included.

Note: Please add three digit color code when ordering.

MA722 1972 split bench w/armrest... 421.99 ea
MA723 1972 rear seat 284.99 ea

Superior
AUTO RESTORATION CO.



MA726878

Superior
AUTO RESTORATION CO.



black blue green

1972 Dart Swinger Upholstery

Diamond cloth inserts and Cologne grain vinyl outers for a factory look and feel. NOS material. Made in USA.

Important: Metal emblems are not included.

Note: No further discounts apply.

Front Split Bench w/Center Armrest

MA726878 1972 black 725.99 ea
MA726880 1972 blue 725.99 ea
MA726882 1972 green 725.99 ea

Hardtop Rear Seat

MA727878 1972 black 562.99 ea
MA727880 1972 blue 562.99 ea
MA727882 1972 green 562.99 ea

Superior
AUTO RESTORATION CO.



MA729100

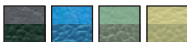

100 black 340 brt blue 445 green 666 gold

1972 Dart Swinger, Demon Upholstery

Shallow Elk grain inserts and Coachman grain outers for a factory look and feel. Fits 1972 Dart Swinger, Swinger Special, Demon, Demon 340, Duster, Duster 340 and Scamp. Made in USA.

Important: Measure the integral headrest from the top center of the insert to the top center of the headrest.

Note: Please add three digit color code when ordering.

Front Split Bench Seat

MA729 1972 with 7" headrest 404.99 ea
MA730 1972 with 9" headrest 404.99 ea

Rear Seat

MA731 1972 hardtop rear seat 284.99 ea

A INTERIOR COMPONENTS

Bench Seat Upholstery

— PLYMOUTH A-BODY • 1971-72 —



1971 Duster & Duster 340 Upholstery

El Paso grain inserts and Coachman grain outers for a factory look and feel. Made in USA.

Note: Please add three digit color code when ordering.
MA719 1971 split bench w/armrest... 421.99 ea
MA718 1971 rear seat 284.99 ea

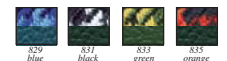

1971 Duster, Duster 340 Cloth Upholstery

Plaid cloth inserts and Coachman grain outers for a factory look and feel. NOS material. Made in USA.

Note: Please add three digit color code when ordering. No further discounts apply.
MA720 1971 front split bench 725.99 ea
MA721 1971 rear seat 597.99 ea

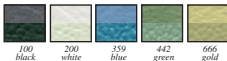

1971 Scamp Vinyl Upholstery

Shallow Elk grain inserts and Coachman grain outers for a factory look and feel. Made in USA.

Important: Metal emblems are not included.
Note: Please add three digit color code when ordering.
MA716 1971 front split bench 404.99 ea
MA715 1971 hardtop rear seat 284.99 ea

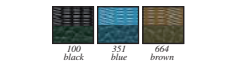

1971 Duster Vinyl Upholstery

3/5 Rib grain inserts and Coachman grain outers for a factory look and feel. Made in USA.

Note: Please add three digit color code when ordering.
MA705 1971 front split bench 404.99 ea
MA706 1971 rear seat 284.99 ea

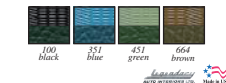

1971 Valiant 4 Door Sedan Vinyl Upholstery

3/5 Rib grain inserts and Coachman grain outers for a factory look and feel. Made in USA.

Note: Please add three digit color code when ordering.
MA705 1971 front split bench 404.99 ea
MA707 1971 4 door sedan rear seat 284.99 ea

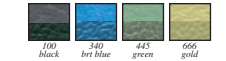

1972 Duster & Scamp Upholstery

Shallow Elk grain inserts and Coachman grain outers for a factory look and feel. Fits 1972 Duster, Duster 340 and Scamp. Made in USA.

Important: Measure the integral headrest from the top center of the insert to the top center of the headrest.
Note: Please add three digit color code when ordering.
MA729 1972 split bench w/H headrest 404.99 ea
MA730 1972 split bench w/H headrest 404.99 ea
MA731 1972 hardtop rear seat 284.99 ea

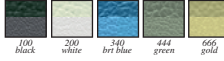

1972 Valiant & Duster Upholstery

Coachman grain inserts and Cologne grain outers for a factory look and feel. Made in USA.

Important: Metal emblems are not included.
Note: Please add three digit color code when ordering.
MA722 1972 split bench w/armrest..... 421.99 ea
MA723 1972 rear seat 284.99 ea

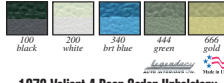

1972 Valiant 4 Door Sedan Upholstery

Coachman grain inserts and Cologne grain outers for a factory look and feel. Fits Dart Custom and Valiant 4 door sedan. Made in USA.

Important: Metal emblems are not included.
Note: Please add three digit color code when ordering.
MA722 1972 split bench w/armrest..... 421.99 ea

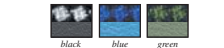

1972 Scamp Upholstery

Diamond cloth inserts and Cologne grain vinyl outers for a factory look and feel. NOS material. Made in USA.

Important: Metal emblems are not included.
Note: No further discounts apply.

Front Split Bench with Center Armrest
MA726878 1972 black 725.99 ea
MA726880 1972 blue 725.99 ea
MA726882 1972 green 725.99 ea
Hardtop Rear Seat
MA727878 1972 black 562.99 ea
MA727880 1972 blue 562.99 ea
MA727882 1972 green 562.99 ea

Bench Seat Upholstery

— DODGE & PLYMOUTH A-BODY • 1972-76 —

Classic
KRM INTERIORS
INC. • EST. 1988



MA724839

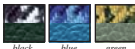

black blue green

1972-73 Dart, Demon & Duster Upholstery

Plaid cloth inserts and Coachman grain vinyl outers for a factory look and feel. Fit 1972-73 Dart Swinger Special, Demon/Dart Sport & Duster. NOS material. Made in USA.

Note: No further discounts apply.

Front Split Bench w/Integral Headrest

MA724831	1972-73	black	747.99 ea
MA724838	1972-73	blue	725.99 ea
MA724830	1972-73	green	725.99 ea

Hardtop Rear Seat

MA725831	1972-73	black	615.99 ea
MA725838	1972-73	blue	597.99 ea
MA725839	1972-73	green	597.99 ea

Classic
KRM INTERIORS
INC. • EST. 1988



MA739352



black parchment bright blue green

1974 Dart, Duster, Scamp Vinyl Upholstery

Shallow Elk grain inserts and Coachman grain outers for a factory look and feel. Fits Dart Swinger, Dart Sport, Duster or Scamp. Rear seat not available for 4 door sedan. Made in USA.

Note: Please add three digit color code when ordering. *No further discounts apply.

Split Bench with Center Armrest

MA739*	1973	parchment - NOS	685.99 ea
MA739*	1973	green - NOS	685.99 ea
MA739	1973	all other colors	421.99 ea

Hardtop Rear Seat

MA740*	1973	parchment - NOS	539.99 ea
MA740*	1973	green - NOS	539.99 ea
MA740	1973	all other colors	276.99 ea

Fold-Down Rear Seat

MA741*	1973	parchment - NOS	539.99 ea
MA741*	1973	green - NOS	539.99 ea
MA741	1973	all other colors	276.99 ea

Classic
KRM INTERIORS
INC. • EST. 1988



MA739253

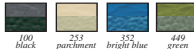

100 black 253 parch 352 bright blue 449 green

1973 Dart, Valiant 4 Door Sedan Upholstery

Shallow Elk grain inserts and Coachman grain outers for a factory look and feel. Fits 1973 Dart Custom and Valiant 4 door sedan. Made in USA.

Note: Please add three digit color code when ordering. *No further discounts apply.

Split Bench with Center Armrest

MA739*	1973	parchment - NOS	685.99 ea
MA739*	1973	green - NOS	685.99 ea
MA739	1973	all other colors	421.99 ea

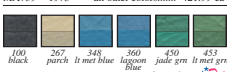

100 black 267 parch lt met blue 348 lt met blue 360 lt met blue 450 jade gr 453 lt met grn

1974-76 Dart Sport, Duster Upholstery

Shallow Elk grain inserts and Oxford grain outers for a factory look and feel. Made in USA.

Note: Please add three digit color code when ordering. *No further discounts apply.

Front Split Bench w/Center Armrest

MA742*	1974-76	parchment - NOS	961.99 ea
MA742*	1974-76	lt. met. green - NOS	961.99 ea
MA742*	1974-76	lt. met. blue - NOS	961.99 ea
MA742	1974-76	all other colors	421.99 ea

Fixed Rear Seat

MA737*	1974-76	parchment - NOS	814.99 ea
MA737*	1974-76	lt. met. green - NOS	814.99 ea
MA737*	1974-76	lt. met. blue - NOS	814.99 ea
MA737	1974-76	all other colors	276.99 ea

Fold-Down Rear Seat

MA738*	1974-76	parchment - NOS	814.99 ea
MA738*	1974-76	lt. met. green - NOS	814.99 ea
MA738*	1974-76	lt. met. blue - NOS	814.99 ea
MA738	1974-76	all other colors	276.99 ea

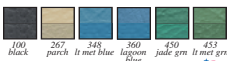

100 black 267 parch lt met blue 348 lt met blue 360 lt met blue 450 jade gr 453 lt met grn

1974-76 Dart, Valiant 4 Door Sedan Upholstery

Shallow Elk grain inserts and Oxford grain outers for a factory look and feel. Fits 1974-76 Dart Custom and Valiant 4 door sedan. Made in USA.

Note: Please add three digit color code when ordering. *No further discounts apply.

Front Split Bench with Center Armrest

MA742*	1974-76	parchment - NOS	961.99 ea
MA742*	1974-76	lt. met. green - NOS	961.99 ea
MA742*	1974-76	lt. met. blue - NOS	961.99 ea
MA742	1974-76	all other colors	421.99 ea

Classic
KRM INTERIORS
INC. • EST. 1988



MA750942



1973 Dart Swinger Cloth Upholstery

Geometric cloth inserts and Coachman grain vinyl outers for a factory look and feel. NOS material. Made in USA.

Note: No further discounts apply.

Front Split Bench w/Center Armrest

MA750942	1973	parchment	725.99 ea
----------	------	-----------	-----------

Hardtop Rear Seat

MA751942	1973	parchment	579.99 ea
----------	------	-----------	-----------

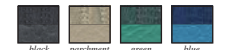

black parchment green blue

1974 Dart & Scamp Cloth Upholstery

Cloth inserts and Oxford grain vinyl outers for a factory look and feel. Fits 1974 Dart Swinger and Scamp. NOS material. Made in USA.

Note: No further discounts apply.

Front Split Bench with Center Armrest

MA752943	1974	black	756.99 ea
MA752944	1974	parchment	1039.99 ea
MA752946	1974	green	756.99 ea
MA752947	1974	blue	756.99 ea

2 Door Hardtop Rear Seat

MA753943	1974	black	597.99 ea
MA753944	1974	parchment	866.99 ea
MA753946	1974	green	597.99 ea
MA753947	1974	blue	597.00 ea

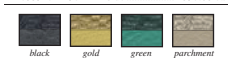

black gold green parchment

1975 Dart, Duster & Scamp Cloth Upholstery

Cloth inserts and Oxford grain vinyl outers for a factory look and feel. Fits 1975 Dart Swinger, Dart Sport, Dart Sport360, Duster & Scamp. NOS material. Made in USA.

Note: No further discounts apply.

Front Split Bench w/Center Armrest

MA752948	1975	black	756.99 ea
MA752949	1975	gold	1039.99 ea
MA752953	1975	green	756.99 ea
MA752954	1975	parchment	1039.99 ea

Fixed Rear Seat

MA753948	1975	black	597.99 ea
MA753949	1975	gold	866.99 ea
MA753953	1975	green	597.99 ea
MA753954	1975	parchment	867.99 ea

Fold-Down Rear Seat

MA754948	1975	black	597.99 ea
MA754949	1975	gold	867.99 ea
MA754953	1975	green	597.99 ea
MA754954	1975	parchment	866.99 ea

A INTERIOR COMPONENTS

Bench Seat Upholstery

— DODGE & PLYMOUTH A-BODY • 1973-76 —

Heavy Foam Backing As Original

Quality is essential when replacing an interior. Although neglected by many manufacturers, our OEM quality upholstery features correct high density foam backing stitched into place exactly as original. Once it's installed, you'll feel the difference!



The Details Matter

Manufactured for correctness in every detail, right down to the stitching!

Correct Manufacturing Techniques

Our upholstery is professionally produced using exact factory specifications. Correct manufacturing techniques allow for a factory-quality appearance and easier installation.

MA74349

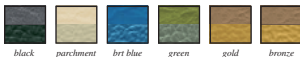

1973 Duster, Scamp Upholstery

Shallow Elk grain inserts and Coachman grain outers for a factory look and feel. Fits Duster or Scamp. Made in USA.

Note: *No further discounts apply.

Part Number	Year	Color	Price
MA743100	1973	black	404.99 ea
MA743253*	1973	parchment - NOS	669.99 ea
MA743352*	1973	bright blue - NOS	404.99 ea
MA743449	1973	green - NOS	669.99 ea
MA743673*	1973	gold - NOS	669.99 ea
MA743675*	1973	bronze - NOS	945.99 ea
Hardtop Rear Seat			
MA744100	1973	black	284.99 ea
MA744253*	1973	parchment - NOS	539.99 ea
MA744352*	1973	bright blue - NOS	284.99 ea
MA744449	1973	green - NOS	539.99 ea
MA744673*	1973	gold - NOS	539.99 ea
MA744675*	1973	bronze - NOS	824.99 ea
Fold-Down Rear Seat			
MA745100	1973	black	284.99 ea
MA745253*	1973	parchment - NOS	539.99 ea
MA745352*	1973	bright blue - NOS	292.99 ea
MA745449	1973	dark green - NOS	539.99 ea
MA745673*	1973	gold - NOS	539.99 ea
MA745675*	1973	bronze - NOS	824.99 ea

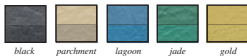

1974 Duster, Scamp Upholstery

Shallow Elk grain inserts and Oxford grain outers for a factory look and feel. Fits Duster or Scamp. Made in USA.

Note: *No further discounts apply.

Part Number	Year	Color	Price
MA746100	1974	black	404.99 ea
MA746267*	1974	parchment - NOS	945.99 ea
MA746360	1974	lagoon blue	404.99 ea
MA746450	1974	jade green	404.99 ea
MA746680*	1974	gold - NOS	945.99 ea
Hardtop Rear Seat			
MA747100	1974	black	284.99 ea
MA747267*	1974	parchment - NOS	824.99 ea
MA747360	1974	lagoon blue	284.99 ea
MA747450	1974	jade green	284.99 ea
MA747680*	1974	gold - NOS	824.99 ea
Fold-Down Rear Seat			
MA748100	1974	black	284.99 ea
MA748267*	1974	parchment - NOS	824.99 ea
MA748360	1974	lagoon blue	284.99 ea
MA748450	1974	jade green	284.99 ea
MA748680*	1974	gold - NOS	824.99 ea

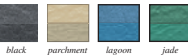

1975 Duster, Scamp Upholstery

Shallow Elk grain inserts and Oxford grain outers for a factory look and feel. Fits Duster or Scamp. Made in USA.

Note: *No further discounts apply.

Part Number	Year	Color	Price
MA749100	1975	black	404.99 ea
MA749267*	1975	parchment - NOS	945.99 ea
MA749360	1975	lagoon blue	404.99 ea
MA749450	1975	jade green	404.99 ea
Fixed Rear Seat			
MA747100	1975	black	284.99 ea
MA747267*	1975	parchment - NOS	824.99 ea
MA747360	1975	lagoon blue	284.99 ea
MA747450	1975	jade green	284.99 ea
Fold-Down Rear Seat			
MA748100	1975	black	284.99 ea
MA748267*	1975	parchment - NOS	824.99 ea
MA748360	1975	lagoon blue	284.99 ea
MA748450	1975	jade green	284.99 ea

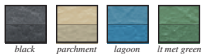

1976 Duster, Scamp Upholstery

Shallow Elk grain inserts and Oxford grain outers for a factory look and feel. Fits Duster or Scamp. Made in USA.

Note: *No further discounts apply.

Part Number	Year	Color	Price
MA749100	1976	black	404.99 ea
MA749267*	1976	parchment - NOS	945.99 ea
MA749348*	1976	lagoon blue/light metallic blue - NOS	709.99 ea
MA749453*	1976	light metallic green - NOS	945.99 ea
Fixed Rear Seat			
MA747100	1976	black	284.99 ea
MA747267*	1976	parchment - NOS	824.99 ea
MA747348*	1976	lagoon blue/light metallic blue - NOS	562.99 ea
MA747453*	1976	light metallic green - NOS	824.99 ea
Fold-Down Rear Seat			
MA748100	1976	black	284.99 ea
MA748267*	1976	parchment - NOS	824.99 ea
MA748348*	1976	lagoon blue/light metallic blue - NOS	562.99 ea
MA748453*	1976	light metallic green - NOS	824.99 ea

Bench Seat Upholstery

— PLYMOUTH B-BODY • 1964-65 —

New!



MB6004510

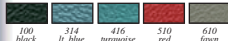

1964 Polara Bench Upholstery
Reproduction upholstery 1964 Polara models. Features heat sealed chrome emblems and Bison grain vinyl for a factory look and feel. Designed with correct split bench design and center arm rest.
Note: Please add three digit color code when ordering.
MB6004 1964 front w/ armrest 594.99 ea
MB6005 1964 hardtop rear 431.99 pr
MB6006 1964 convertible rear ... 431.99 pr

Leisure
AUTO RESTORATION CO.



MB618100

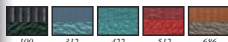

1964 Fury Upholstery
1/16 Rib grain inserts with heat sealed chrome accent band, silver accent welt and Bison grain outers for a factory look and feel. Made in USA.
Note: Please add three digit color code when ordering.
Front Split Bench
MB615 1964 435.99 ea
Hardtop Rear Seat
MB616 1964 337.99 ea
Convertible Rear Seat
MB617 1964 337.99 ea

Leisure
AUTO RESTORATION CO.



MB613905

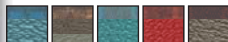

1964 Fury Cloth Upholstery
Cloth inserts with heat sealed chrome accent band, silver accent welt and Bison grain vinyl outers for a factory look and feel. NOS material. Made in USA.
Note: Please add three digit color code when ordering. No further discounts apply.

MB613	1964	front split bench	814.99 ea
MB614	1964	rear seat	689.99 ea

Leisure
AUTO RESTORATION CO.



MB618512



1964 Fury 4 Door Hardtop & Wagon Upholstery
1/16 Rib grain inserts with heat sealed chrome accent band, silver accent welt and Bison grain outers for a factory look and feel. Made in USA.
Note: Rear seat for 4 door hardtop is not available.
**No further discounts apply.*

Front Straight Bench			
MB618100	1964	black	479.99 ea
MB618312	1964	blue	479.99 ea
MB618422	1964	turquoise	479.99 ea
MB618512	1964	red	479.99 ea
MB618686	1964	chestnut	479.99 ea
MB618697*	1964	fawn - NOS	771.99 ea
Wagon Rear Seat			
MB619100	1964	black	282.99 ea
MB619312	1964	blue	282.99 ea
MB619422	1964	turquoise	282.99 ea
MB619512	1964	red	282.99 ea
MB619686	1964	chestnut	282.99 ea
MB619697*	1964	fawn - NOS	644.99 ea

Leisure
AUTO RESTORATION CO.



MB620381

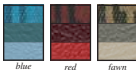

1964 Savoy Cloth Upholstery
Cloth inserts and Bison grain vinyl outers for a factory look and feel. NOS material. Made in USA.
Note: No further discounts apply.

Front Split Bench			
MB620381	1964	blue	779.99 ea
MB620581	1964	red	779.99 ea
MB620696	1964	fawn	779.99 ea
2 Door Sedan Rear Seat			
MB621381	1964	blue	597.99 ea
MB621581	1964	red	597.99 ea
MB621696	1964	fawn	597.99 ea

Leisure
AUTO RESTORATION CO.



MB622894

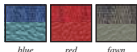

1965 Belvedere I Cloth Upholstery
Cloth inserts and Bison grain vinyl outers for a factory look and feel. NOS material. Made in USA.
Note: No further discounts apply.

Front Split Bench			
MB622893	1965	blue	765.99 ea
MB622894	1965	red	765.99 ea
MB622895	1965	fawn	765.99 ea
2 Door Sedan Rear Seat			
MB623893	1965	blue	586.99 ea
MB623894	1965	red	586.99 ea
MB623895	1965	fawn	586.99 ea



MB624100



1965 Belvedere II Vinyl Upholstery
Cologne grain inserts with Bison grain outers and Cologne grain accents for a factory look and feel. Made in USA.
*Note: Please add three digit color code when ordering. *No further discounts apply.*

Front Split Bench			
MB624	1965	gold - NOS	757.99 ea
MB624	1965	all other colors	471.99 ea
Hardtop Rear Seat			
MB625	1965	gold - NOS	639.99 ea
MB625	1965	all other colors	334.99 ea
Convertible Rear Seat			
MB626*	1965	gold - NOS	639.99 ea
MB626	1965	all other colors	334.99 ea

INTERIOR COMPONENTS

Bench Seat Upholstery

— DODGE & PLYMOUTH B-BODY • 1965-66 —



MB627705

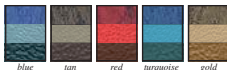

blue tan red turquoise gold



1965 Belvedere II Cloth Upholstery

Cloth inserts with Cologne grain vinyl accents and Bison grain vinyl outers for a factory look and feel. NOS material. Made in USA.

Note: No further discounts apply.

Front Split Bench

MB627701	1965	blue cloth	821.99 ea
MB627703	1965	tan cloth	899.99 ea
MB627705	1965	red cloth	821.99 ea
MB627707	1965	turquoise cloth	821.99 ea
MB627719	1965	gold cloth	899.99 ea

Hardtop Rear Seat

MB628701	1965	blue cloth	677.99 ea
MB628703	1965	tan cloth	719.99 ea
MB628705	1965	red cloth	677.99 ea
MB628707	1965	turquoise cloth	677.99 ea
MB628719	1965	gold cloth	762.99 ea



MB636723

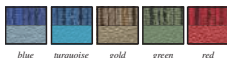

blue turquoise gold green red



1966 Belvedere II Cloth Upholstery

Cloth inserts and Cologne grain vinyl outers for a factory look and feel. NOS material. Made in USA.

Note: No further discounts apply.

Front Split Bench

MB636721	1966	blue	765.99 ea
MB636723	1966	turquoise	765.99 ea
MB636725	1966	gold	985.99 ea
MB636727	1966	red	765.99 ea
MB636729	1966	red	765.99 ea

Hardtop Rear Seat

MB637721	1966	blue	807.99 ea
MB637723	1966	turquoise	807.99 ea
MB637725	1966	gold	866.00 ea
MB637727	1966	green	607.99 ea
MB637729	1966	green	607.99 ea



MB638415

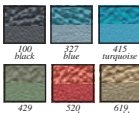

100 black 327 blue 415 turquoise
429 green 520 red 619 gold



1966 Belvedere II Vinyl Upholstery

Crater grain inserts and Cologne grain outers for a factory look and feel. Made in USA.

Note: Please add three digit color code when ordering. *No further discounts apply.

2 Door Hardtop Front Split Bench

MB638*	1966	gold - NOS	756.99 ea
MB638	1966	all other colors	404.99 ea

4 Door Sedan Front Bench

MB639*	1966	gold - NOS	756.99 ea
MB639	1966	all other colors	404.99 ea

Hardtop Rear Seat

MB640*	1966	gold - NOS	615.99 ea
MB640	1966	all other colors	284.99 ea

Convertible Rear Seat

MB641*	1966	gold - NOS	615.99 ea
MB641	1966	all other colors	284.99 ea
MB642*	1966	gold - NOS	284.99 ea
MB642	1966	all other colors	284.99 ea



MB643715



gold red dark blue



1966 Belvedere I Cloth Upholstery

Cloth inserts with 1/4 Rib grain vinyl upper inserts and Cologne grain vinyl outers for a factory look and feel. NOS material. Made in USA.

Note: No further discounts apply.

Front Split Bench

MB643715	1966	gold	985.99 ea
MB643717	1966	red	765.99 ea
MB643718	1966	dark blue	765.99 ea

2 Door Sedan Rear Seat

MB644715	1966	gold	866.99 ea
MB644717	1966	red	607.99 ea
MB644718	1966	dark blue	607.99 ea



MB647323

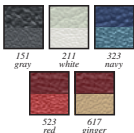

151 gray 211 white 323 navy
523 red 617 ginger



1966 Coronet 440 Upholstery

Cirrus grain inserts and Cologne grain outers for a factory look and feel.

Note: Please add three digit color code when ordering. *No further discounts apply.

2 Door Hardtop Front Split Bench

MB647*	1966	gold - NOS	709.99 ea
MB647	1966	all other colors	404.99 ea

Hardtop Rear Seat

MB648*	1966	red - NOS	607.99 ea
MB648	1966	all other colors	284.99 ea

Convertible Rear Seat

MB649*	1966	red - NOS	607.99 ea
MB649	1966	all other colors	284.99 ea



MB650868

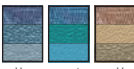

blue turquoise gold



1966 Coronet Deluxe Cloth Upholstery

Cloth inserts and Cologne grain vinyl outers for a factory look and feel. NOS material. Made in USA.

Note: No further discounts apply.

Front Split Bench

MB650867	1966	blue	765.99 ea
MB650868	1966	turquoise	765.99 ea
MB650869	1966	gold	985.99 ea

2 Door Sedan Rear Seat

MB651867	1966	blue	607.99 ea
MB651868	1966	turquoise	607.99 ea
MB651869	1966	gold	866.99 ea

Bench Seat Upholstery

— DODGE & PLYMOUTH B-BODY • 1967 —



MB658107



black/silver



Made in USA

1967 Belvedere II Silver Special Upholstery

Boar grain heat sealed center panel and inserts with Cologne grain outers for a factory look and feel. Made in USA.

Note: Metal emblems not included.

2 Door Hardtop Front Split Bench

MB658107 1967 black/silver..... 535.99 ea

4 Door Sedan Front Bench

MB659107 1967 black/silver..... 535.99 ea

Hardtop Rear Seat

MB660107 1967 black/silver..... 535.99 ea

Convertible Rear Seat

MB661107 1967 black/silver..... 535.99 ea

4 Door Sedan Rear Seat

MB662107 1967 black/silver..... 535.99 ea



Made in USA



black pearl blue red brown copper

1967 Belvedere II Vinyl Upholstery

Bambino grain inserts and Cologne grain outers for a factory look and feel. Metal emblems not included. Made in USA.

*Note: *No further discounts apply.*

2 Door Hardtop Front Split Bench

MB663100 1967 black..... 535.99 ea

MB663202 1967 pearl white..... 421.99 ea

MB663327 1967 blue..... 421.99 ea

MB663520 1967 red..... 421.99 ea

MB663627* 1967 copper - NOS..... 685.99 ea

4 Door Sedan Front Bench

MB664100 1967 black..... 421.99 ea

MB664327 1967 blue..... 421.99 ea

MB664520 1967 red..... 421.99 ea

MB664623* 1967 brown/gold - NOS..... 961.99 ea

Hardtop Rear Seat

MB665100 1967 black..... 299.99 ea

MB665202 1967 pearl white..... 299.99 ea

MB665327 1967 blue..... 299.99 ea

MB665520 1967 red..... 299.99 ea

MB665627* 1967 copper - NOS..... 574.99 ea

Convertible Rear Seat

MB667100 1967 black..... 299.99 ea

MB667202 1967 pearl white..... 299.99 ea

MB667327 1967 blue..... 299.99 ea

MB667520 1967 red..... 299.99 ea

MB667627* 1967 copper - NOS..... 574.99 ea

4 Door Sedan Rear Seat

MB668100 1967 black..... 299.99 ea

MB668327 1967 blue..... 299.99 ea

MB668520 1967 red..... 299.99 ea

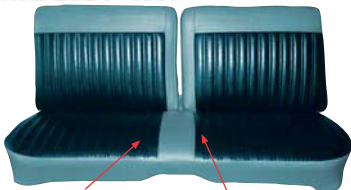

MB671327

Correct Manufacturing Techniques

Professionally produced using exact factory specifications. Correct manufacturing techniques allow for a factory appearance and easier installation.

Correct Grains and Colors

Each style and color is specifically produced to match the original in weight and grain. You can be assured that this upholstery will give your interior authenticity and a factory fresh appearance.

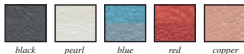

black pearl blue red copper

1967 Coronet 440 Upholstery

Dorchester grain inserts and Cologne grain outers with heat sealed top panels for a factory look and feel. Made in USA.

Note: Metal emblems not included.

Front Split Bench

MB671100 1967 black..... 421.99 ea

MB671202 1967 pearl white..... 421.99 ea

MB671327 1967 blue..... 421.99 ea

MB671520 1967 red..... 421.99 ea

MB671620 1967 copper..... 421.99 ea

Hardtop Rear Seat

MB672100 1967 black..... 299.99 ea

MB672202 1967 pearl white..... 299.99 ea

MB672327 1967 blue..... 299.99 ea

MB672520 1967 red..... 299.99 ea

MB672620 1967 copper..... 282.99 ea

Convertible Rear Seat

MB673100 1967 black..... 299.99 ea

MB673202 1967 pearl white..... 299.99 ea

MB673327 1967 blue..... 299.99 ea

MB673520 1967 red..... 299.99 ea

MB673620 1967 copper..... 299.99 ea

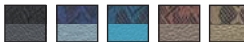

black blue turquoise brown gold

1967 Belvedere II Cloth Upholstery

Cloth inserts and Cologne grain vinyl outers for a factory look and feel. NOS Metal. Made in USA.

Note: No further discounts apply.

Hardtop Front Split Bench

MB669741 1967 black..... 765.99 ea

MB669743 1967 blue..... 765.99 ea

MB669745 1967 turquoise..... 765.99 ea

MB669747 1967 brown..... 765.99 ea

MB669749 1967 gold..... 985.99 ea

Rear Seat

MB670741 1967 black..... 607.99 ea

MB670743 1967 blue..... 607.99 ea

MB670745 1967 turquoise..... 607.99 ea

MB670747 1967 brown..... 607.99 ea

MB670749 1967 gold..... 866.99 ea



Made in USA



INTERIOR COMPONENTS

Bench Seat Upholstery

— DODGE & PLYMOUTH B-BODY • 1968 —



MB681100

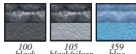

1968 Belvedere & Road Runner Standard

Rosette grain inserts and Cologne grain outers for a factory look and feel. Made in USA.

Note: Please add three digit color code when ordering.
 MB681 1968 coupe front split bench... 404.99 ea
 MB500 1968 headrest cover 81.99 pr
 MB682 1968 rear seat 284.99 ea

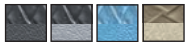

1968 Belvedere, Coronet & Road Runner Deluxe Upholstery

Reed grain inserts and Cologne grain outers for a factory look and feel. Made in USA.

Note: Please add three digit color code when ordering. *No further discounts apply.
SHOULDER SEWER
 Coupe Split Bench
 MB685* 1968 fawn - NOS 701.99 ea
 MB685 1968 all other colors 404.99 ea

Headrest Covers
 MB500 1968 81.99 pr
Rear Seat
 MB686* 1968 fawn - NOS 589.99 ea
 MB686 1968 all other colors 284.99 ea



MB693529

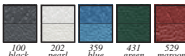

1968 Coronet 440 & Super Bee Upholstery

Ascot grain inserts and Cologne grain outers for a factory look and feel. Made in USA.

Important: Metal emblems not included.
 Note: Please add three digit color code when ordering.
 MB693 1968 hardtop fit split bench 404.99 ea
 MB500 1968 headrest covers 81.99 pr
 MB694 1968 rear seat 284.99 ea



MB700430

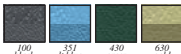

1968 Coronet 500 Convertible Upholstery

Ascot grain inserts and Cologne grain outers for a factory look and feel. Please add the three digit color code suffix to the part number when ordering. Made in USA.

MB700 1968 conv. front split bench... 404.99 ea
 MB500 1968 headrest covers 81.99 pr
 MB699 1968 rear seat 284.99 ea



MB701100

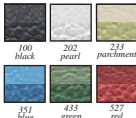

1968 Satellite & Road Runner Decor Upholstery

Ascot grain inserts and Bambino grain outers for a factory look and feel. Pearl white is for hardtop models only. NOS material. Made in USA.

Important: Metal emblems not included.
 Note: Please add three digit color code when ordering.
 *No further discounts apply on NOS material.

Front Split Bench
 MB703* 1968 patch w/gold insert 701.99 ea
 MB703 1968 all other colors 435.99 ea
Headrest Covers
 MB704 1968 all colors 81.99 pr
Hardtop Rear Seat
 MB705* 1968 patch w/gold insert 589.99 ea
 MB705 1968 all other colors 316.99 ea
Convertible Rear Seat
 MB706 1968 all other colors 316.99 ea



MB701865

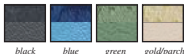

1968 Satellite Cloth Upholstery

Cloth inserts and Cologne grain vinyl outers for a factory look and feel. NOS material. Made in USA.

Note: No further discounts apply.
SHOULDER SEWER

Hardtop Front Split Bench
 MB701865 1968 black 709.99 ea
 MB701859 1968 blue 709.99 ea
 MB701857 1968 green 709.99 ea
 MB701861 1968 gold/parchment 1064.99 ea
Headrest Covers
 MB500100 1968 black 81.99 pr
 MB500332 1968 blue 81.99 pr
 MB500432 1968 green 81.99 pr
 MB500230 1968 parchment 171.99 pr
Rear Seat
 MB597865 1968 black 607.99 ea
 MB597859 1968 blue 607.99 ea
 MB597857 1968 green 607.99 ea
 MB597861 1968 gold/parchment 955.99 ea



Basic Upholstery Installation Kit

Classic Industries® offers a basic upholstery installation kit including high quality hog ring pliers. Kits includes hog ring pliers and enough hog rings to install one complete upholstery set.
 K10000 basic installation kit 8.99 kit
 K10010A 60 pc. hog ring set 6.99 kit



Deluxe Upholstery Installation Kit

Classic Industries® offers a professional kit including high quality hog ring pliers. This kit includes hog ring pliers and enough hog rings to install one complete upholstery set. The pliers provided with this kit are considered heavy duty and easier to work with when installing upholstery.
 K10010 professional installation kit 24.99 kit
 K10010A 60 pc. hog ring set 6.99 kit

Bench Seat Upholstery

— DODGE & PLYMOUTH B-BODY • 1969-70 —



MB720100

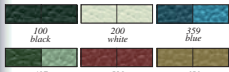

1969 Coronet 440 & Super Bee Upholstery

Coachman grain inserts and outers for a factory look and feel. Made in USA.

- Note: Please add three digit color code when ordering.*
 MB720 1969 hardtop fir split bench 421.99 ea
 MB501 1969 headrest covers..... 81.99 pr
 MB721 1969 rear seat..... 299.99 ea



MB683651

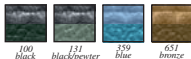

1969 Belvedere, Coronet & Road Runner Upholstery

Rosette grain inserts and Coachman grain outers for a factory look and feel. Standard upholstery for 1969 Belvedere and Road Runner. Deluxe for 1969 Coronet. Made in USA.

- Note: Please add three digit color code when ordering.*
 MB683 1969 coupe fir split bench. 404.99 ea
 MB501 1969 headrest covers..... 81.99 pr
 MB684 1969 rear seat..... 284.99 ea



1969 Belvedere & Road Runner Deluxe

Reed grain inserts and Coachman grain outers for a factory look and feel. Made in USA.

- Note: Please add three digit color code when ordering.*
 MB687 1969 coupe fir split bench. 404.99 ea
 MB501 1969 headrest cover..... 81.99 pr
 MB684 1969 rear seat..... 259.99 ea



MB726870

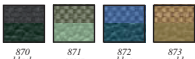

1969 Satellite Cloth Upholstery

Cloth inserts and Coachman grain vinyl outers for a factory look and feel. NOS material.

- Note: Please add three digit color code when ordering. No further discounts apply.*
- | | |
|--------------------------------------|-----------|
| MB726 1969 2 dr hdp fir split bench | 709.99 ea |
| MB727 1969 4 dr sedan front bench. | 709.99 ea |
| MB501 1969 headrest covers..... | 81.99 pr |
| MB702 1969 hardtop rear seat..... | 607.99 ea |
| MB728 1969 4 door sedan rear seat... | 607.99 ea |



MB729100

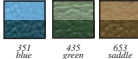
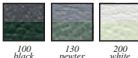

1969 Satellite & Road Runner Decor Upholstery

Ascot grain inserts and Coachman grain outers for a factory look and feel. Please add the three digit color code suffix to the part number when ordering. Made in USA.

- Note: Metal emblems not included.*
 MB729 1969 front split bench..... 404.99 ea
 MB501 1969 headrest covers..... 81.99 pr
 MB730 1969 hardtop rear seat..... 284.99 ea
 MB731 1969 convertible rear seat..... 284.99 ea



MB744434

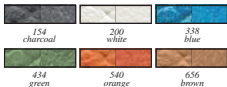

1970 Charger Split Bench Upholstery

Diamond Basketweave grain inserts and Krinkle grain outers for a factory look and feel. Made in USA.

- Note: Please add three digit color code when ordering.*
 MB744 1970 front split bench..... 404.99 ea
 MB740 1970 rear seat..... 316.99 ea

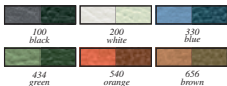

1970 Coronet 440 & Super Bee Upholstery

Vexon grain inserts and Coachman grain outers for a factory look and feel. Made in USA.

- Note: Please add three digit color code when ordering.*
 MB745 1970 front split bench..... 404.99 ea
 MB746 1970 rear seat..... 284.99 ea



MB750100



1970 Coronet 500 Convertible Upholstery

Shallow Elk grain inserts and Coachman grain outers for a factory look and feel. Made in USA.

- Note: Please add three digit color code when ordering.*
 MB750 1970 split bench w/tr armrest 421.99 ea
 MB749 1970 rear seat..... 276.99 ea

A INTERIOR COMPONENTS

Bench Seat Upholstery

— PLYMOUTH B-BODY • 1970 —



MB735367



165 charcoal 367 blue 663 brown

1970 Belvedere, Road Runner Std Upholstery

Laredo grain inserts and Coachman grain outers for a factory look and feel. NOS material. Made in USA.

Note: Please add three digit color code when ordering.

MB735	1970	coupe front split bench	404.99 ea
MB736	1970	rear seat	259.99 ea



MB751773



black bright blue green

1970 Satellite Cloth Upholstery

Cloth inserts and Coachman grain vinyl outers for a factory look and feel. NOS material. Made in USA.

Note: No further discounts apply.

Front Split Bench

MB751771	1970	black	744.99 ea
MB751773	1970	bright blue	744.99 ea
MB751777	1970	green	744.99 ea

Rear Seat

MB752771	1970	black	607.99 ea
MB752773	1970	bright blue	607.99 ea
MB752777	1970	green	607.99 ea



MB753965

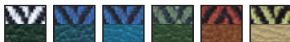

black blue bright blue green orange gold



1970 Sport Satellite, GTX Cloth Upholstery

Geometric cloth inserts and Coachman grain vinyl outers for a factory look and feel. NOS material. Made in USA.

Important: Rear bench not available for 4 door sedan models.

Note: No further discounts apply.

2 Door - Front Split Bench with Center Armrest

MB753961	1970	black	761.99 ea
MB753965	1970	bright blue	761.99 ea
MB753969	1970	orange	761.99 ea

4 Door Sedan - Front Split Bench with Center Armrest

MB753963	1970	blue	761.99 ea
MB753967	1970	green	761.99 ea
MB753971	1970	gold	1135.99 ea

2 Door - Rear Seat

MB754961	1970	black	607.99 ea
MB754965	1970	bright blue	607.99 ea
MB754969	1970	orange	607.99 ea



MB758443

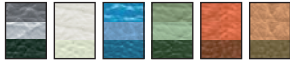

103 black/silver 200 white 367 blue 443 540 burnt orange 663 brown



1970 Satellite, Road Runner Deluxe

Laredo grain inserts with 2" accent collar and Coachman grain outers for a factory look and feel. Fits Satellite, Road Runner and Superbird. Please add the three digit color code suffix to the part number when ordering. Made in USA.

Note: Metal emblems not included.

MB758	1970	front split bench	435.99 ea
MB759	1970	hardtop rear seat	311.99 ea
MB760	1970	convertible rear seat	311.99 ea

Bench Seat Upholstery

— DODGE & PLYMOUTH B-BODY • 1971-72 —

Classic
RESTORATION
PRODUCTS
INC.



MB761200

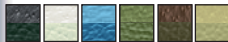

100 black 200 white 340 blue 452 green 664 brown 666 gold

1971 Charger & Super Bee Deluxe Upholstery

Derma grain inserts and Coachman grain outers for a factory look and feel. Made in USA.

Important: Metal emblems not included.

Note: Please add three digit color code when ordering.

MB761 1971 front split bench..... 404.99 ea

MB762 1971 rear seat..... 284.99 ea

Classic
RESTORATION
PRODUCTS
INC.



MB763823

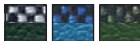

811 black 821 blue 823 green

1971 Charger 500 Cloth/Vinyl Upholstery

Salt & Pepper cloth inserts and Coachman grain vinyl outers for a factory look. NOS material. Made in USA.

Note: Please add three digit color code when ordering.

No further discounts apply.

Split Bench with Armrest

MB763 1971 black..... 1095.99 ea

MB763 1971 all other colors..... 1064.99 ea

Rear Seat

MB764 1971 black..... 894.99 ea

MB764 1971 all other colors..... 867.99 ea



MB769841



841 black 843 blue 845 green 847 tan

1971 Charger SE Cloth Upholstery

Ribbed cloth inserts and Belmont grain vinyl outers for a factory look and feel. NOS material. Made in USA.

Note: Please add three digit color code when ordering.

MB769 1971 split bench w/armrest 761.99 ea

MB763 1971 rear seat..... 597.99 ea

Classic
RESTORATION
PRODUCTS
INC.



MB778340



charcoal/black bright blue tan/brown

1971 Satellite, Road Runner Std Upholstery

El Paso grain inserts and Coachman grain outers for a factory look and feel. Made in USA.

Front Split Bench

MB778168 1971 char/black w/black..... 404.99 ea

MB778340 1971 bright blue..... 404.99 ea

MB778665 1971 tan/brown..... 404.99 ea

Rear Seat

MB779168 1971 charcoal/black..... 284.99 ea

MB779340 1971 bright blue..... 284.99 ea

MB779665 1971 tan/brown..... 284.99 ea

Classic
RESTORATION
PRODUCTS
INC.



MB778168



charcoal/black bright blue tan/brown

1971 Charger Standard Upholstery

El Paso grain inserts and Coachman grain outers for a factory look and feel. Made in USA.

Front Split Bench

MB778168 1971 char/black w/black..... 404.99 ea

MB778340 1971 bright blue..... 404.99 ea

MB778665 1971 tan/brown..... 404.99 ea

Rear Seat

MB779168 1971 charcoal/black..... 284.99 ea

MB779340 1971 bright blue..... 284.99 ea

MB779665 1971 tan/brown..... 284.99 ea

Classic
RESTORATION
PRODUCTS
INC.



MB780445

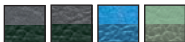

100 black 152 charcoal/black 340 bri blue 445 lt green/dk green

1972 Charger Standard Upholstery

Shallow Elk grain inserts and Coachman grain outers for a factory look and feel. Made in USA.

Note: Please add three digit color code when ordering.

MB780 1972 front split bench..... 404.99 ea

MB781 1972 rear seat..... 276.99 ea

Classic
RESTORATION
PRODUCTS
INC.



MB772200



100 black 140 gunmetal 152 charcoal



200 white 340 bright blue 451 green



666 gold 668 tan

1971 Satellite, Road Runner Deluxe Upholstery

Shallow Elk grain inserts and Coachman grain outers for a factory look and feel. Fits Satellite Sebring and Road Runner. Made in USA.

Important: Metal emblems not included.

Note: Please add three digit color code when ordering.

MB772 1971 front split bench..... 404.99 ea

MB773 1971 rear seat..... 284.99 ea

INTERIOR COMPONENTS

Bench Seat Upholstery

— DODGE & PLYMOUTH B-BODY • 1972-73 —

Seamless
AUTO INTERIORS LTD.



MB782662

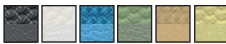

100 black 200 white 340 blue 444 green 662 brown 666 gold

1972 Charger & Charger SE Deluxe Upholstery

Ranger grain inserts and Cologne grain outers for a factory look and feel. Made in USA.

Note: Please add three digit color code when ordering.

MB782 1972 front split bench..... 404.99 ea
MB783 1972 rear seat..... 284.99 ea

Seamless
AUTO INTERIORS LTD.



MB780152

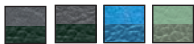

100 black 152 charcoal/black 340 bright blue 445 green

1972 Satellite, Road Runner Std Upholstery

Shallow Elk grain inserts and Coachman grain outers for a factory look and feel. Made in USA.

Note: Please add three digit color code when ordering.

MB780 1972 front split bench..... 404.99 ea
MB781 1972 rear seat..... 276.99 ea



K10010

K10000



Seat Upholstery Installation Kits

Classic Industries® offers your choice of a basic upholstery installation kit (for one-time or occasional use) or a deluxe kit that includes professional grade hog ring pliers. Either kit includes hog ring pliers and enough hog rings to install one complete upholstery set. Additional hog rings are also sold separately in our 60 pc hog ring kit.

K10000 basic installation kit..... 8.99 kit
K10010 deluxe installation kit..... 24.99 kit
K10010A 60 pc. hog ring kit..... 6.99 kit

Seamless
AUTO INTERIORS LTD.



MB784444

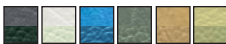

100 black 200 white 340 blue 444 green 662 brown 666 gold

1972 Satellite, Road Runner Deluxe Upholstery

Shallow Elk grain inserts and Coachman grain outers for a factory look and feel. Fits 1972 Satellite Sebring and Road Runner. Made in USA.

Important: Metal emblems not included.

Note: Please add three digit color code when ordering.

MB784 1972 front split bench..... 404.99 ea
MB785 1972 rear seat..... 284.99 ea

Seamless
AUTO INTERIORS LTD.



MB791253



100 black 253 parchment 352 blue 449 green 673 bronze

1973 Charger, Road Runner, Satellite Upholstery

Shallow Elk grain inserts and Coachman grain outers for a factory look and feel. Fits 1973 Charger, Road Runner & Satellite. Made in USA.

Important: Metal emblems not included.

Note: Please add three digit color code when ordering. *No further discounts apply.

Front Split Bench

MB791 1973 black..... 404.99 ea
MB791* 1973 blue - Limited..... 404.99 ea
MB791* 1973 all other colors - NOS..... 669.99 ea

Rear Seat

MB792 1973 black..... 284.99 ea
MB792* 1973 blue - Limited..... 284.99 ea
MB792* 1973 all other colors - NOS..... 554.99 ea

Seamless
AUTO INTERIORS LTD.



MB796673

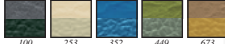

100 black 253 parchment 352 blue 449 green 673 bronze

1973 Charger SE Upholstery

Shallow Elk grain inserts and Coachman grain outers for a factory look and feel. Made in USA.

Note: Please add three digit color code when ordering. *No further discounts apply.

Front Split Bench with Center Armrest

MB799 1973 black..... 421.99 ea
MB799* 1973 blue - NOS..... 421.99 ea
MB799* 1973 other colors - NOS..... 719.99 ea

Rear Seat

MB800 1973 black..... 284.99 ea
MB800 1973 blue..... 284.99 ea
MB800* 1973 other colors - NOS..... 554.99 ea



MB801931

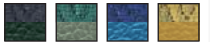

927 black 928 green 931 blue 934 gold

1973 Charger SE Cloth Upholstery

Cloth inserts with buttons and Coachman grain vinyl outers for a factory look and feel. NOS material. Made in USA.

Note: Please add three digit color code when ordering. *No further discounts apply.

Front Split Bench

MB801 1973 w/all cloth armrest..... 725.99 ea
MB802 1973 w/cloth/vinyl armrest 725.99 ea

Rear Seat

MB803 1973 all..... 607.99 ea

Bench Seat Upholstery

— DODGE & PLYMOUTH B-BODY • 1974 —



MB810935

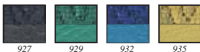

927 black 929 green 932 blue 935 gold



1974 Charger SE & Satellite Sebring Plus Cloth Upholstery

Cloth inserts with buttons and Oxford grain outers for a factory look and feel. NOS material. Made in USA.

Note: Please add three digit color code when ordering. No further discounts apply.

Front Split Bench with All-Cloth Center Armrest

MB809 1974 gold1004.99 ea

MB809 1974 all other colors 725.99 ea

Front Split Bench with Cloth/Vinyl Center Armrest

MB810 1974 honey gold1004.99 ea

MB810 1974 all other colors 725.99 ea

Rear Seat

MB811 1974 gold 866.99 ea

MB811 1974 all other colors 607.99 ea



MB804100

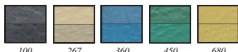

100 black 267 parchment 360 blue 450 green 680 gold

1974 Charger SE Vinyl Upholstery

Shallow Elk grain inserts and Oxford grain outers for a factory look and feel. Made in USA.

Note: Please add three digit color code when ordering.

Front Split Bench with Center Armrest

MB804* 1974 parchment - NOS1039.99 ea

MB804* 1974 gold - NOS1039.99 ea

MB804 1974 all other colors 421.99 ea

Hardtop Rear Seat

MB805* 1974 parchment - NOS 909.99 ea

MB805* 1974 gold - NOS 909.99 ea

MB805 1974 all other colors 284.99 ea



MB793267



100 black 267 parchment 360 blue 450 green 680 gold

1974 Charger Vinyl Upholstery

Richmond grain inserts and Oxford grain outers for a factory look and feel. Made in USA.

Important: Metal emblems not included.

Note: Please add three digit color code when ordering.

**No further discounts apply.*

Front Split Bench

MB793* 1974 parchment - NOS 985.99 ea

MB793* 1974 gold - NOS 985.99 ea

MB793 1974 all other colors 404.99 ea

Rear Seat

MB794* 1974 parchment - NOS 866.99 ea

MB794* 1974 gold - NOS 866.99 ea

MB794 1974 all other colors 284.99 ea



MB795100

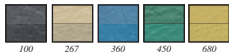

100 black 267 parchment 360 blue 450 green 680 gold

1974 Satellite, Road Runner Deluxe Vinyl Upholstery

Shallow Elk grain inserts and Oxford grain outers for a factory look and feel. Fits 1974 Satellite Sebring and Road Runner. Made in USA.

Note: Please add three digit color code when ordering.

**No further discounts apply.*

Front Split Bench

MB795* 1974 parchment - NOS 985.99 ea

MB795* 1974 gold - NOS 985.99 ea

MB795 1974 all other colors 404.99 ea

Rear Seat

MB796* 1974 parchment - NOS 866.99 ea

MB796* 1974 gold - NOS 866.99 ea

MB796 1974 all other colors 284.99 ea

Bench Seat Upholstery

— DODGE & PLYMOUTH E-BODY • 1970-71 —



ME704338

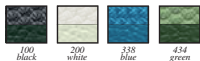

1970 Barracuda & 'Cuda Upholstery

Ranger grain inserts and Coachman grain outers for a factory look and feel. Made in USA.
Note: Please add three digit color code when ordering.

Front Split Bench Seat

ME704 1970 with center armrest 461.99 ea

Hardtop Rear Seat

ME702 1970 hardtop rear seat 284.99 ea



MB720338



1970 Challenger, R/T, & SE Vinyl Upholstery

Your choice of Regal grain inserts and Coachman grain outers or Coachman grain inserts and Coachman grain outers for a factory look and feel. Made in USA.

Regal Grain Inserts and Coachman Grain Outers

Front Split Bench with Center Armrest

ME720100 1970 black 461.99 ea

ME720338 1970 blue 461.99 ea

Hardtop Rear Seat

ME715100 1970 black 284.99 ea

ME715338 1970 blue 284.99 ea

Coachman Grain Inserts and Coachman Grain Outers

Front Split Bench with Center Armrest

ME721100 1970 black 461.99 ea

ME721338 1970 blue 461.99 ea

Hardtop Rear Seat

ME718100 1970 black 284.99 ea

ME718338 1970 blue 284.99 ea

Kustom
INTERIORS, INC.



ME732200

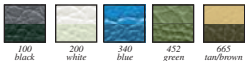

1971 Barracuda & 'Cuda Standard Upholstery

El Paso grain inserts and Coachman grain outers for a factory look and feel. Made in USA.

Important: Front bucket seat upholstery is available with or without cord welting surrounding the seat insert.

Note: Please add three digit color code when ordering.

Front Split Bench with Center Armrest

ME732 1971 without insert welting 431.99 ea

ME733 1971 with insert welting 431.99 ea

Rear Seat

ME730 1971 hardtop rear seat 284.99 ea

ME731 1971 convertible rear seat 284.99 ea

Kustom
INTERIORS, INC.



ME748452

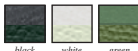

1971 Challenger Deluxe Upholstery

Belmont grain inserts and Coachman grain outers for a factory look and feel. Made in USA.

Front Split Bench with Center Armrest

ME748100 1971 black 461.99 ea

ME748200 1971 white 461.99 ea

ME748452 1971 green 461.99 ea

Hardtop Rear Seat

ME75100 1971 black 284.99 ea

ME751200 1971 white 284.99 ea

ME751452 1971 green 284.99 ea

PROCAR Bucket Seats



817004BK

817001BE

817004GR



817004RD

817004BL

817004YL



black vinyl beige vinyl blk velour gray velour red velour blue velour yellow velour

Procar Rave Reclining Bucket Seats

ProCar RAVE seats provide high-tech styling with generous lateral support and the convenience of a recliner; perfect for the street enthusiast and occasional weekend warrior who is concerned with performance but still wants to drive comfortably when not on the track. These Performance Seats have openings to accommodate 5-point racing harnesses, an integrated recliner mechanism, large bolsters, and a fixed headrest. With ProCar seat mounting adaptors (sold separately), these seats are ready for direct bolt-in installation. The TIG-welded, all-steel frame is electrostatically coated for maximum strength and durability. Features include Procar's exclusive one-touch backrest recline/release. Seat sliders are included.

Note: Shipped double oversize.

Part No.	Material	Price
817001BK	LH black vinyl	389.99 ea
817002BK	RH black vinyl	389.99 ea
817001BE	LH beige vinyl	389.99 ea
817002BE	RH beige vinyl	389.99 ea
817003BK	LH black velour	389.99 ea
817004BK	RH black velour	389.99 ea
817003GR	LH grey velour	389.99 ea
817004GR	RH grey velour	389.99 ea
817003RD	LH red velour	389.99 ea
817004RD	RH red velour	389.99 ea
817003BL	LH blue velour	389.99 ea
817004BL	RH blue velour	389.99 ea



816001BK

816001WH

816001RD



816009GRBK

816009RDBK

816009BLEK

Sportsman Pro Seats Fit Either Driver or Passenger Side!



black vinyl ivory vinyl red vinyl blk vinyl w/ blk velour black vinyl w/ red velour black vinyl w/ blue velour

Procar Sportsman Pro Reclining Bucket Seats

Complete and ready to install, the Sportsman Pro Sport Recliner offers high tech styling and comfort perfect for any vehicle. These seats have a large bolster to hold you in the seat under hard cornering conditions, fixed head rest and pass-throughs for 5-point harnesses. All-steel frame is TIG-welded for strength with injection molded foam for maximum comfort and durability. Micro recliner mechanism allows you to adjust the seat back to ensure your maximum comfort. Lever to allow the seat to move forward for easy access to rear seat. The seat back is a beautiful black fiber composite material. No assembly required, comes standard with sliders. Mounting adaptors sold separately.

Note: Shipped double oversize.

Part No.	Material	Price
816001BK	black vinyl	219.99 ea
816001WH	ivory vinyl	219.99 ea
816001RD	red vinyl	219.99 ea
816009GRBK	black velour/black vinyl	219.99 ea
816009RDBK	red velour/black vinyl	219.99 ea
816009BLEK	blue velour/black vinyl	219.99 ea

PROCAR Bucket Seats



812001BK



814001BK



815001WH

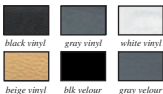

PROCAR Rally Reclining Bucket Seats

Complete and ready to install, the Rally series reclining seat features vertical stitching for a vintage look with pronounced side bolsters for added support under hard cornering! The TIG-welded, all-steel frame is electrostatically coated for maximum strength and durability. Features include a map pocket on seat back, and Procar's exclusive one-touch backrest recline/release. Available with adjustable headrest or as a lowback seat. Seat sliders are included. Mounting adapters sold separately.

Rally Recliner with Headrest

811001 LH vinyl	389.99 ea
811002 RH vinyl	389.99 ea
811007 LH vinyl/velour	449.99 ea
811008 RH vinyl/velour	449.99 ea
811003 LH velour	449.99 ea
811004 RH velour	449.99 ea
811005 LH black leather	809.99 ea
811006 RH black leather	809.99 ea
811011 LH bare uncovered seat	329.99 ea
811012 RH bare uncovered seat	329.99 ea

Rally Recliner Lowback

812001 LH vinyl	379.99 ea
812002 RH vinyl	379.99 ea
812007 LH vinyl/velour	439.99 ea
812008 RH vinyl/velour	439.99 ea
812003 LH velour	439.99 ea
812004 RH velour	439.99 ea
812005 LH black leather	784.99 ea
812006 RH black leather	784.99 ea
812011 LH bare uncovered seat	319.99 ea
812012 RH bare uncovered seat	319.99 ea

Procar Pro-90 Reclining Bucket Seats

Complete and ready to install, the Pro-90 series reclining seat is a perfect replacement for the enthusiast seeking modern seating comfort at an affordable price. Available with adjustable headrest or as a lowback seat. Seat sliders are included. Mounting adapters sold separately.

Pro-90 Recliner w/Headrest

814001 LH vinyl	299.99 ea
814002 RH vinyl	299.99 ea
814003 LH velour	359.99 ea
814004 RH velour	359.99 ea
814011 LH bare seat	239.99 ea
814012 RH bare seat	239.99 ea

Pro-90 Recliner Lowback

815001 LH vinyl	259.99 ea
815002 RH vinyl	259.99 ea
815003 LH velour	329.99 ea
815004 RH velour	329.99 ea
815011 LH bare seat	224.99 ea
815012 RH bare seat	224.99 ea

Elite Series 1100 Complete Bucket Seats

The Elite 1100 series is a contemporary style seat that adds a sporty look to any vehicle.

A perfect upgrade for the enthusiast that's seeking a modern appearance.

Seats sport easy one-touch backrest adjustment, map pocket, and TIG-welded all-steel frame. Seat sliders are included. Mounting adapters sold separately.

801161 LH black velour	409.99 ea
801162 LH gray velour	409.99 ea
801164 RH gray velour	409.99 ea
801165 LH beige velour	409.99 ea
801166 RH beige velour	409.99 ea



PROCAR

Sliders are included with seats

Adapters are listed here



PROCAR Mopar Seat Mounting Adapters

Seat adapters are designed to make the transition from original seats to Procar seats easy. Each adapter is designed to allow the seat to be installed for each year listed.

A-Body

81340 1965-69 LH - Barracuda	94.99 ea
81341 1965-69 RH - Barracuda	94.99 ea
81432 1967-76 LH - Dart	84.99 ea
81433 1977-76 RH - Dart	84.99 ea

B-Body

81342 1966-74 LH - Charger	99.99 ea
81343 1966-74 RH - Charger	99.99 ea
81342 1966-71 LH - Coronet	99.99 ea
81343 1966-71 RH - Coronet	99.99 ea
81342 1967-74 LH - Satellite	99.99 ea
81343 1967-74 RH - Satellite	99.99 ea

E-Body

81760 1970-74 LH - Barracuda	114.99 ea
81761 1970-74 RH - Barracuda	114.99 ea
81760 1970-74 LH - Challenger	114.99 ea
81761 1970-74 RH - Challenger	114.99 ea

Bucket Seat Foam

OER AUTHORIZED

New!

OER AUTHORIZED



SF150

SF151

SF152



SF153

SF154

SF156



1960-74 A & B-Body Bucket Seat Foam

Reproduction seat foam for various 1960-74 Dodge and Plymouth models. Get an OE fit and original appearance by offering quality OER® Authorized seat foam.

Note: Single seat foam is shipped oversize. Pair of seat foam is shipped double oversize.

#083 #082

1960-71 A-Body Bucket Seat Foam

SF150	1960-65	Barracuda, Dart, Lancer, Valiant - per seat.....	129.99 ea
MD2007	1960-65	Barracuda, Dart, Lancer, Valiant - pair.....	233.99 pr
SF151	1966-67	Barracuda, Dart, Valiant - per seat.....	129.99 ea
MD2008	1966-67	Barracuda, Dart, Valiant - pair.....	233.99 pr
SF152	1968-69	Barracuda, Dart, Valiant - per seat.....	129.99 ea
MD2009	1968-69	Barracuda, Dart, Valiant - pair.....	233.99 pr
SF153	1970-71	Demon, Duster (vinyl style) - per seat.....	129.99 ea
MD2010	1970-71	Demon, Duster (vinyl style) - pair.....	233.99 pr
SF154	1971	Dart Swinger, Scamp (vinyl style) - per seat.....	129.99 ea
MD2011	1971	Dart Swinger, Scamp (vinyl style) - pair.....	233.99 pr

1962-65 B-Body Bucket Seat Foam

Fits 1962-64 Fury, 1962-65 Belvedere, 1965 Coronet and 1965 Satellite.			
SF150	1962-65	all with bucket seats - per seat.....	129.99 ea
MD2007	1962-65	all with bucket seats - pair.....	233.99 pr

1966-67 B-Body Bucket Seat Foam

Fits front bucket seats on 1966-67 Belvedere, Charger, Coronet, Satellite and 1967 GTX. Note: Not for use on 1966-67 Charger rear bucket seats.			
SF151	1966-67	all with bucket seats - per seat.....	129.99 ea
MD2008	1966-67	all with bucket seats - pair.....	233.99 pr

1968-69 B-Body Bucket Seat Foam

Fits front bucket seats on 1968-69 Belvedere, Charger, Coronet, GTX, Road Runner, Satellite and Super Bee.			
SF152	1968-69	all with bucket seats - per seat.....	129.99 ea
MD2009	1968-69	all with bucket seats - pair.....	233.99 pr

1970 B-Body Bucket Seat Foam

Fits front bucket seats on 1970 Road Runner, GTX, and Sport Satellite.			
SF153	1970	all with bucket seats - per seat.....	129.99 ea
MD2010	1970	all with bucket seats - pair.....	233.99 pr

1971-74 B-Body Bucket Seat Foam

Fits front bucket seats on 1971-74 Charger, GTX, Road Runner, Satellite, and Super Bee.			
SF156	1971-74	all with bucket seats - per seat.....	129.99 ea
MD2050	1971-74	all with bucket seats - pair.....	233.99 pr

Style 1



Style 1 - has a shallow standard bolster

SF154

Style 2



Style 2 - has a vertical pleat

15123

Style 3



Style 3 - has a more pronounced bolster

SF153

Style 4



Style 4 - has a lumbar support bolster

SF155



1970-72 E-Body Bucket Seat Foam

1970-72 E-Body bucket seat foam came in four styles. Each bucket seat foam set includes one pair of seat bottoms, one pair of seat backs, and one pair of headrest cups. Choose the style of seat foam that matches your style of seat upholstery.

Important: During the years 1970-71 E-Body seat foam varied in shape according to the seat style and type of seat cover material being used. It is important that you order the seat foam that is correct for your specific seat style as the foam will not interchange.

Note: Single seat foam is shipped oversize. Pair of seat foam is shipped double oversize.

1970-71 E-Body Bucket Seat Foam, Style 1

Style 1 can be identified by the seat material, its shallow bolster and the vertical or horizontal pleats on the seat cover. Fits 1970-71 'Cuda (leather style), 1970-71 Barracuda Gran Coupe (leather style) and 1970 Challenger (vinyl style).

SF154	1970-71	per seat.....	129.99 ea
MD2011	1970-71	pair.....	233.99 pr

1971 E-Body Bucket Seat Foam, Style 2

Style 2 can be identified by the single vertical pleat that runs the entire length of the seat cover from top to bottom and a single horizontal pleat that forms a cross shape on the seat top. Fits 1971 Barracuda (standard style vinyl), 1971 'Cuda (standard style vinyl) and 1971 Challenger (standard style vinyl).

15123	1971	per seat.....	129.99 ea
MD2012	1971	pair.....	233.99 pr

1970-71 E-Body Bucket Seat Foam, Style 3

Style 3 can be identified by the seat material and by the pronounced bolster and inserts. This style fits 1970 'Cuda (vinyl), 1970 Barracuda Gran Coupe (vinyl or cloth) and 1971 Challenger (cloth).

SF153	1970-71	per seat.....	129.99 ea
MD2010	1970-71	pair.....	233.99 pr

1970-71 E-Body Bucket Seat Foam, Style 4

Style 4 can be identified by the seat material and by the horizontal lumbar bolster that runs across lower portion of seat back. This style fits 1971 'Cuda (deluxe vinyl style), 1970 Challenger (cloth style), 1970-71 Challenger (leather style), 1971 Challenger (deluxe vinyl style).

SF155	1970-71	per seat.....	129.99 ea
MD2013	1970-71	pair.....	233.99 pr

1972 Dodge Challenger Bucket Seat Foam

Bucket seat foam for 1972 Dodge Challenger models.			
15143	1972	per seat.....	129.99 ea
MD2061	1972	pair.....	233.99 pr

Seat Components



ME861010

1970-74 Challenger Seat Frames

Reproduction seat frame assemblies for 1970-74 Dodge Challenger models. Each assembly features a stamped steel frame and includes hinges and spring assemblies for a complete replacement.

ME861010 1970-74 left..... 399.99 ea
ME861011 1970-74 right..... 399.99 ea



1970-71 E-Body Upper Rear Seat Frame

Replace your rusted or missing upper rear seat frame with this all new reproduction. Manufactured to factory specifications and designed as a precise replacement for the original. Includes new seat foam. Fits 1970-71 convertible Barracuda and Challenger models.

ME861006 1970-71 convertible..... 694.99 ea



AK50102

Upholstery Installation Kits

These padding kits for 1960-76 A, B, and E-Body seats come with material to insulate and pad seat frames prior to installing new upholstery.

Note: *Shipped oversize.

Front Bucket Seats

Includes burlap, listing wire, and 2" felt.
AK50101 1960-76 A, B, E-Body..... 22.99 kit

Front Bench Seats

Includes 1-1/2" foam, cotton roll, burlap, listing wire, muslin, and 2" felt.
AK50104* 1962-74 A, B, E-Body..... 211.99 kit

Rear Bench Seats

Includes 1-1/2" foam, cotton roll, burlap, listing wire & muslin
AK50102* 1962-74 A, B, E-Body..... 211.99 kit

Universal Foam Sheet

This universal foam sheet is 1-1/2" thick and measures 36" x 68".
SF119* 1962-74 A, B, E-Body..... 69.99 ea



MA118520

1967-76 Bucket Seat Reinforcements

These reinforcements are designed to reinforce the floor panel when converting from bench to bucket seats. Welds to the inside of the floor near the transmission tunnel to prevent the bucket seat mounts from tearing the floor pan. One set required per vehicle.

MA118520 1967-76 A-Body..... 19.99 set
MB192021 1971-74 B-Body..... 19.99 set

New!



MB184622

1967-74 Bucket Seat Track Assemblies

Reproduction bucket seat track assemblies for 1968-74 A, B, and E-Body cars. Manufactured to original specifications, these stamped steel seat tracks will replace the originals precisely. Comes with tension springs pre-installed.

A-Body
MA688006 1970-72 LH..... 184.99 ea
MA688007 1970-72 RH..... 184.99 ea

B-Body
MB184621 1968-69 LH..... 184.99 ea
MB184622 1968-69 RH..... 184.99 ea
MB184625 1968-69 LH, 6-way..... 514.99 ea
MB184623 1970 LH..... 184.99 ea
MB184624 1970 RH..... 184.99 ea

E-Body
ME16283 1970-74 LH bucket..... 109.99 pr
ME16282 1970-74 RH bucket..... 109.99 pr
ME861009 1970-71 LH bucket, 6-way..... 514.99 ea
ME16284 1970-74 bench..... 109.99 pr

New!



MD475004

MD475012

1968-72 Seat Track Components

Get your seat track back in working order with these quality restoration components. Each piece is manufactured to replicate the original in appearance and in function.

Bucket Seat Knobs

MN3250 1960-65 A/B-Body..... 13.99 ea
MD475015 1966-70 A/B/E-Body..... 47.99 pr
MD475004 1971-72 B/E-Body..... 94.99 pr
MD475005 1970-71 6 way adjustable... 41.99 pr

Bench Seat Knobs

MN3250 1960-65 A/B-Body..... 13.99 ea

Hardware

MD475007 1968-69 spacers (4)..... 21.99 set
MD475008 1968-69 nuts (8)..... 21.99 set
MD475009 1968-69 B-Body sm spring..... 14.99 ea
MD475010 1968-69 B-Body lg spring..... 19.99 ea
MD475011 1970-72 A-Body lg spring..... 19.99 ea

Release Cables - OEM

MD475013 1966-69 release cable..... 19.99 set
MD475012 1969-71 release cable..... 19.99 set



1964-76 Center Armrest Hinge Washer

Protect the vinyl on your seat upholstery from wear caused by the center armrest and eliminate what could be a very expensive problem with a very inexpensive solution. This pair of hinge washers will fit all 1964-76 vehicles equipped with center armrest

MD2031 1964-76..... 4.99 pr

AUTHENTIC RESTORATION



1966-70 A & B-Body Seat Mounting Pad Set

Replace the deteriorated fiber spacers and rusty washers on the bottom of your bucket or bench seats with our excellent quality spacer and washer set. This set comes with four new injection molded ABS plastic spacers and four correct serrated locking washers. It is designed to fit most 1966-70 A-Body and B-Body vehicles equipped with bench or bucket seats including Dart, Valiant, Duster, Belvedere, Charger, Coronet, GTX, Road Runner, Satellite and Super Bee. One set will do a complete bench seat or one bucket seat.

Note: Two sets required for vehicles with bucket seats.
MD2029 1966-70..... 11.99 set

AUTHENTIC RESTORATION



1963-65 A & B-Body Bucket Seat Back Stops

Keep your front seat back in the correct upright position with a new set of bucket seat back stops from Classic Industries®. These nylon bumpers mount on the back side of the front seat bottoms and eliminate rattling and other problems associated with worn or missing seat backstops. Includes one pair of nylon seat back stops to fit 1963-65 A-Body and 1963-65 B-Body vehicles
MD2032 1963-65..... 15.99 pr

AUTHENTIC RESTORATION



MD2033

MD2034

1970-72 B & E-Body Bucket Seat Back Stops

Keep your front seat back in the correct upright position with a new set of bucket seat back stops from Classic Industries®. These nylon bumpers mount on the back side of the front seat bottoms and eliminate rattling and other problems associated with worn or missing seat backstops. For 1970-72 B-Body and E-Body vehicles with bucket seats.

MD2033 1970-72 stops..... 11.99 pr
MD2034 1970-72 stops with studs..... 18.99 set

Seat Components



MD2014100



black white

1964-67 B-Body Bench Seat Hinge Covers

Details make the difference when it comes to a quality interior. If your B-Body Belvedere, Coronet, Fury, or Satellite has cracked or missing seat hinge covers, these replacement covers will add the finishing touch to your upholstery. Manufactured in ABS plastic, these seat hinge covers hide the unsightly hinges on each side of your bench seat. Available in black or white and are sold as a pair.

Belvedere, Coronet, Fury, Satellite

MD2014100 1964-67 black..... 39.99 pr
 MD2014200 1964-67 white..... 59.99 pr



MD2016100

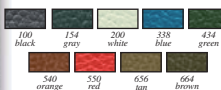

1968-70 A & B-Body Bench Seat Hinge Covers

If your A-Body Dart, Valiant, Duster or B-Body, Belvedere, Charger, Coronet, Road Runner, Satellite, or GTX has cracked or missing seat hinge covers, these replacement covers will add the finishing touch to your upholstery. Manufactured in ABS plastic, these seat hinge covers hide the unsightly hinges on each side of your bench seat. Sold as a pair.

Note: Please add three digit color code when ordering.
 MD2016 1968-70 black or white..... 39.99 pr
 MD2017 1968-70 factory colors..... 59.99 pr

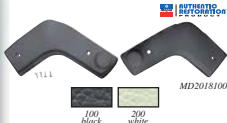

MD2018100



1970-76 A & B-Body Bench Seat Hinge Covers

If your 1970-76 A-Body Dart, Demon, Valiant, Duster or Scamp or 1973-74 E-Body Barracuda, Cuda or Challenger has cracked or missing seat hinge covers, these replacement covers will add the finishing touch to your upholstery. Manufactured in ABS plastic, these seat hinge covers hide the unsightly hinges on each side of your bench seat. Available in black or white and are sold as a pair.

Note: Please add three digit color code when ordering.
 MD2018 1970-76..... 39.99 pr



MD2020100



100 black 200 white

1971-74 B-Body Bench Seat Hinge Covers

If your B-Body Charger, GTX or Road Runner has cracked or missing seat hinge covers, these replacement covers will add the finishing touch to your upholstery. Manufactured in ABS plastic, these seat hinge covers hide the unsightly hinges on each side of your bench seat. Sold as a pair.

Note: Please add three digit color code when ordering.

Charger, GTX, Road Runner
 MD2020 1971-74..... 44.99 pr



MD2022100



100 black 200 white 340 blue 444 green

1973-76 A-Body Bench Seat Hinge Covers

Details make the difference when it comes to a quality interior. If your Dart, Valiant, Duster or Scamp has cracked or missing seat hinge covers, these replacement covers will add the finishing touch to your upholstery. Manufactured in fiberglass, these seat hinge covers hide the unsightly hinges on each side of your bench seat. Sold as a pair.

Note: Please add three digit color code when ordering.

1973-76 A-Body
 MD2022 1973-76 black or white..... 99.99 pr
 MD2023 1973-76 factory colors..... 99.99 pr



MD2049100



100 black 154 gray 200 white 338 blue 434 green

1968-69 A & B-Body Bucket Seat Hinge Covers

Details make the difference when it comes to a quality interior. If your vehicle has cracked or missing seat hinge covers, these replacement covers will add the finishing touch to your upholstery. Manufactured in ABS plastic, these seat hinge covers hide the unsightly hinges on each side of your bucket seats. For select A-Body vehicles including Barracuda, Dart, Valiant and B-Body vehicles including Belvedere, Charger, Coronet, GTX, Road Runner, Satellite or Super Bee. Sold as a pair, two pairs required per vehicle.

Note: Please add three digit color code when ordering.

MD2049 1968-69 black..... 39.99 pr
 MD2051 1968-69 factory colors..... 59.99 pr



MD2024100



100 black 200 white 340 blue 444 green

1972-74 Bucket Seat Hinge Covers

Manufactured in ABS plastic, these seat hinge covers hide the unsightly hinges on each side of your bucket seats. For select 1973-75 A-Body, 1972-74 B-Body and 1973-74 E-Body vehicles. Sold as a pair, two pairs required per vehicle.

Important: Two styles were used for A-Body, please verify your style before ordering.

Note: Please add three digit color code when ordering.

1973-75 A-Body
 MD2024 1973-75 black..... 39.99 pr
 MD2025 1973-75 factory colors..... 59.99 pr

1972-74 B-Body
 MD2024 1972-74 black..... 39.99 pr
 MD2025 1972-74 factory colors..... 59.99 pr

1973-74 E-Body
 MD2024 1972-74 black..... 39.99 pr
 MD2025 1972-74 factory colors..... 59.99 pr



MD2026

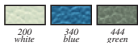

200 white 340 blue 444 green

1973-76 A-Body Bucket Seat Hinge Cover Set

Manufactured in ABS plastic, this seat hinge cover set hides the unsightly hinges on each side of your bucket seats. For select 1973-76 A-Body vehicles including Dart, Valiant, Duster or Scamp. One set required per vehicle.

Important: Two styles were used for A-Body, please verify your style before ordering.

Note: Please add the three digit color code when ordering.

1973-76 A-Body
 MD2026 1973-76 black..... 159.99 set
 MD2027 1973-76 factory colors..... 169.99 set



1966-74 Bucket Seat Hinge Washer Set

Protect the skirts on your upholstery from wear by replacing the broken or missing hinge washers with a set of replacement washers from Classic Industries®. These black panel board washers come in a set of 4 and will fit all 1966-74 A-Body models.

MD2030 1966-74 4 piece..... 3.99 set

A INTERIOR COMPONENTS

Seat Components



1968-69 A & B-Body Seat Release Knob Set

Seat release knobs for 1968-69 A-Body and B-Body models. Replace those broken, corroded or missing original knobs with a new set to add the finishing touch to your interior. Fits all 2 door models with bench or bucket seats. Each set includes 2 knobs and hardware. MD2035 1968-69..... 49.99 set



1970-74 Bucket Seat Latch & Spacer Sets

Replace the inoperative or missing seat latches on your bucket seats to keep the seat back securely locked in the upright position. This set is designed to fit most 1970-74 A-Body, B-Body and E-Body vehicles equipped with bucket seats. Each set includes one LH latch, one RH latch and four spacers. MD2028 1970-74..... 29.99 set

New!



1970-74 E-Body Bucket Seat Latch Kit

Reproduction bucket seat latch kit for 1970-74 E-Body models. Includes latch, catch, and spacer. Must re-use original hardware. MP17101 1970-74 LH..... 69.99 kit
MP17102 1970-74 RH..... 69.99 kit



1968-70 A & B-Body Headrest Gaskets

If you are dyeing or refurbishing your original headrests, complete the job with a new set of gaskets for an authentic original appearance. The gaskets install on the bottom side of the headrest where the post inserts into the headrest pad. They are designed to cover the unsightly hole in between the two posts for a pleasant factory fresh appearance. For 1968-70 A-Body models as well as 1968-70 B-Body models. MD2046 1968-70..... 19.99 pr



1968-70 A & B-Body Headrest Chrome Bands

Repair your 1968-70 molded headrests with a new set of chrome bands. If your headrests are in good shape other than the chrome band, this is an economical alternative to replacing the entire headrest. Each kit comes with enough material to do two headrests. For 1968-70 A-Body models as well as 1968-70 B-Body cars. MD2021 1968-70..... 49.99 pr

New!



Cosmetically correct from the mounting posts to the material grain.

Features correct chrome molding that wraps around the headrest.

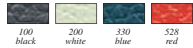

1968-70 Molded Headrests

Missing or deteriorated headrests no longer have to be a headache. Replace your damaged or missing originals with a quality set from Classic Industries™. These correct replacement headrests will fit 1968-70 A-Body models including Barrauda, Dart and Valiant as well as 1968-70 B-Body models including Belvedere, Coronet, GTX, Road Runner, Satellite and Super Bee. Each set of headrests features the posts and correct molding. Available for bench or bucket seats. MD2015 1968-70 bench seats..... 294.99 set
MD2019 1968-70 bucket seats..... 324.99 set



1968-70 Headrest Rebuild Kit with Bezels

This comprehensive kit will repair inoperable headrests in 1968-70 A-Body models as well as 1968-70 B-Body models. Each kit includes everything required to get both of your headrests operating smoothly. Can also be used to install headrests in a car not originally equipped with headrests. Whether your car was equipped with bucket seats or bench seats, we have a kit for your seat configuration. MD2047 1968-70 bucket seats..... 134.99 set
MD2048 1968-70 bench seats..... 134.99 set



1969-70 B-Body Headrest Bezels

Reproduction of the bench seat headrest post bezels for 1969-70 Charger and Road Runner models. Manufactured as original with a bright chrome finish. Includes attaching screws. 2 required per headrest. Sold individually. 2942847 1969-70 bench seat..... 9.99 ea



New!



1968-70 Bench Seat Release Knob & Bezel

OER® reproduction bench seat back release knob and bezel for 1968-70 Dodge and Plymouth A.B. & E-Body models. Manufactured from die-cast zinc with a chrome finish as original. Sold individually, two required per seat. Knob includes installation screw. MD475013 1968-70 knob..... 19.99 ea
MD475006 1968-70 bezel..... 31.99 ea



1969 Coronet/Super Bee Seat Medallions

Die cast reproduction seat medallions for 1969 Coronet and Super Bee models with bucket seats. Features correct glossy black fill as original. Product of Canada. MD15102 1969..... 54.99 pr



1967 GTX Rear Seat Emblem & Plate

Reproduction rear seat plate and emblem for 1967 GTX hardtop models. Features correct polished chrome and flat black finish as original. Available as an individual emblem or as a complete assembly with plate. GTX Rear Seat Emblem with Plate MB280898 1967..... 204.99 ea
GTX Rear Seat Emblem Only 2840214 1967 Made in USA..... 42.99 ea

Seat Components

AUTHORIZED



MD473100



MD474100



MD474200



100 black 200 white 338 blue 550 red



1970-74 Injection Molded Bucket Seat Backs

Reproduction seat back panels for 1970-72 A-Body, 1970-71 B-Body, and 1970-74 E-Body models. Manufactured in injection molded ABS plastic with the correct Coachman grain to duplicate the originals precisely. Two styles are offered to fit the high back bucket seats in A-Body, B-Body and E-Body vehicles. There was a mid-year change in seat backs during the 1971 model year which resulted in there being an "early style" and "late style" seat back. The "early style" seat backs have a square look and shorter hinge extensions and are for 1970-71 models built through 12/01/70. The "late style" seat backs are more pointed at the top, have longer hinge extensions and are for vehicles built from 12/02/70. Sold as a pair.

Important: A design change during the 1971 model year resulted in different seat designs. Please order according to date of manufacture.
Note: Please add three digit color code when ordering.

1970-71 A, B, & E-Body

Note: Early "square-look" design for 1970-71 vehicles built up to 12/01/1970.
MD473 1970-71 269.99 pr

1971-72 A-Body & E-Body

Note: "Pointed-look" design for vehicles built 12/02/1970 and later.
MD474 1971-72 269.99 pr

1971-74 B-Body

Note: "Pointed-look" design for vehicles built 12/02/1970 and later.
MD474 1971-74 269.99 pr



MD2036100

Early style square look design for 1970-71 vehicles built up to 12/01/1970.

Late style pointed look design for vehicles built 12/02/1970 and later.



MD2038100

1970-74 Bucket Seat Back Color Chart

	100 - Black	154 - Charcoal	200 - White	338 - Bri Blue	340 - Bri Blue	360 - Laguna	434 - Green
1970	X	X	X	X	X	X	X
1971	X	X	X	X	X	X	X
1972	X	X	X	X	X		X
1973	X	X	X	X	X		X
1974	X	X		X	X		

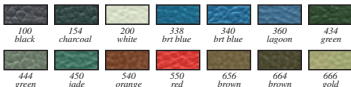

1970-74 Vacuum Formed Bucket Seat Backs

These seat backs are vacuum formed in ABS plastic with a Coachman grain just like the originals and are offered in twelve original colors. Two styles are offered to fit the high back bucket seats in A-Body, B-Body and E-Body vehicles. There was a mid-year change in seat backs during the 1971 model year which resulted in there being an "early style" and "late style" seat back. The "early style" seat backs have a square look and shorter hinge extensions and are for 1970-71 models built through 12/01/70. The "late style" seat backs are more pointed at the top, have longer hinge extensions and are for vehicles built from 12/02/70. Sold as a pair.

Important: A design change during the 1971 model year resulted in different seat designs. Please order according to date of manufacture.
Note: Please add three digit color code when ordering.

1970-71 A, B, & E-Body

Note: early "square-look" design for 1970-71 vehicles built up to 12/01/1970.
MD2036 1970-71 black or white 149.99 pr
MD2037 1970-71 factory colors 198.99 pr

1971-72 A-Body & E-Body

Note: "pointed-look" design for vehicles built 12/02/1970 and later.
MD2038 1971-72 black or white 149.99 pr
MD2039 1971-72 factory colors 198.99 pr

1971-74 B-Body

Note: "pointed-look" design for vehicles built 12/02/1970 and later.
MD2038 1971-74 black or white 149.99 pr
MD2039 1971-74 factory colors 198.99 pr

A INTERIOR COMPONENTS

Seat Finishing Components

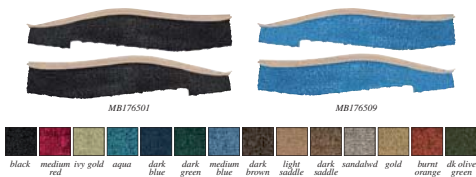

1966-67 B-Body Conversion Rear Seat Lower Trim Panels

Reproduction rear seat lower trim panel for 1966-67 convertible Satellite, GTX, and Coronet models. This trim carpet covers the panel below the rear seat bottom and above the floor carpeting. Designed to fit the contours of the original panel to provide an authentic, color-keyed replacement. Available in all original colors for each respective model and year.

1966 Coronet Convertible			
MB176501	1966	black	65.99 pr
MB176502	1966	medium red	65.99 pr
MB176504	1966	ivy gold	65.99 pr
MB176505	1966	aqua	65.99 pr
MB176507	1966	dark blue	65.99 pr
MB176509	1966	medium blue	65.99 pr
MB176511	1966	light saddle	65.99 pr
MB176521	1966	burnt orange	65.99 pr
MB176530	1966	dark olive green	65.99 pr

1966 Satellite Convertible			
MB176501	1966	black	65.99 pr
MB176502	1966	medium red	65.99 pr
MB176504	1966	ivy gold	65.99 pr
MB176505	1966	aqua	65.99 pr
MB176507	1966	dark blue	65.99 pr
MB176509	1966	medium blue	65.99 pr
MB176511	1966	light saddle	65.99 pr
MB176521	1966	burnt orange	65.99 pr
MB176530	1966	dark olive green	65.99 pr

1967 Coronet Convertible			
MB176501	1967	black	65.99 pr
MB176502	1967	medium red	65.99 pr
MB176504	1967	ivy gold	65.99 pr
MB176505	1967	aqua	65.99 pr
MB176507	1967	dark blue	65.99 pr
MB176509	1967	medium blue	65.99 pr
MB176511	1967	light saddle	65.99 pr
MB176512	1967	dark saddle	65.99 pr
MB176519	1967	sandalwood	65.99 pr
MB176520	1967	gold	65.99 pr
MB176521	1967	burnt orange	65.99 pr
MB176530	1967	dark olive green	65.99 pr

1967 Satellite Convertible			
MB176501	1967	black	65.99 pr
MB176502	1967	medium red	65.99 pr
MB176504	1967	ivy gold	65.99 pr
MB176505	1967	aqua	65.99 pr
MB176507	1967	dark blue	65.99 pr
MB176508	1967	dark green	65.99 pr
MB176509	1967	medium blue	65.99 pr
MB176510	1967	dark brown	65.99 pr
MB176511	1967	light saddle	65.99 pr
MB176519	1967	sandalwood	65.99 pr
MB176521	1967	burnt orange	65.99 pr
MB176530	1967	dark olive green	65.99 pr

1967 GTX Convertible			
MB176501	1967	black	65.99 pr
MB176502	1967	medium red	65.99 pr
MB176504	1967	ivy gold	65.99 pr
MB176505	1967	aqua	65.99 pr
MB176507	1967	dark blue	65.99 pr
MB176508	1967	dark green	65.99 pr
MB176509	1967	medium blue	65.99 pr
MB176510	1967	dark brown	65.99 pr
MB176519	1967	sandalwood	65.99 pr
MB176521	1967	burnt orange	65.99 pr
MB176530	1967	dark olive green	65.99 pr



MD2042



MD2043



MP14055

1968-69 Bucket Seat Back Boards

Reproduction seat back boards for 1968-69 A and B-body models equipped with bucket seats. Each pair is die-cut from durable fiberboard. The upper board installs beneath the foam cap on the upper portion of the seat back and then the seat cover fits over it. The lower board is ready to be covered in your choice of vinyl and then it installs with clips to conceal and cover the open portion of the seat back. For 1968-69 A-Body and 1968-69 B-Body vehicles. Sold as a pair. One pair required per vehicle.

Note: Must raise bottom edge rails to install lower panel.
 MD2042 1968-69 upper board..... 29.99 pr
 MD2043 1968-69 lower board..... 35.99 pr
 MP14055 1968-69 clip set - 2 req..... 29.99 set



MD2045

1968-70 Bench Seat Back Boards

Replace warped, missing or deteriorated original seat back boards with these die-cut boards to give the back of your split bench seats a new appearance once again. Each pair is made of durable black fiberboard and ready to be covered in your choice of vinyl. Sold as a pair for split-bench seat applications only. One pair required per vehicle. Patterns are available for 1968-69 A-Body vehicles including Barracuda, Dart and Valiant as well as 1966-70 B-Body models including Belvedere, Coronet, GTX, Road Runner, Satellite and Super Bee.

Note: Must reuse original clips and bottom edge rails.
A-Body
 MD2044 1968-70 bench seat..... 35.99 pr
B-Body
 MD2045 1966-67 bench seat..... 35.99 pr
 MD2044 1968-70 bench seat..... 35.99 pr

A-Body Seat Back Panels



MA9220101



MA9220349

Vinyl Color Chart

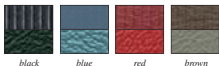

1964 Valiant Signet Front Bucket Seat Back Panels

New pre-cut, pre-sewn vinyl front bucket seat back panels with new boards. These will help finish off your new upholstery. Made in USA.

MA9220101	1964	black	161.99	pr
MA9220349	1964	blue	161.99	pr
MA9220502	1964	red	161.99	pr
MA9220658	1964	brown	161.99	pr



MA9121510



MA9121614

Vinyl Color Chart

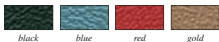

1965 Valiant Signet Front Bucket Seat Back Panels

New pre-cut, pre-sewn vinyl front bucket seat back panels with new boards. These will help finish off your new upholstery.

MA9121100	1965	black	161.99	pr
MA9121314	1965	blue	161.99	pr
MA9121510	1965	red	161.99	pr
MA9121614	1965	gold	161.99	pr



MA9022100

Vinyl Color Chart

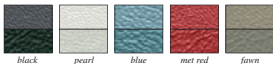

Carpet Color Chart

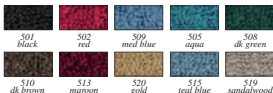

1965 Dart GT Bucket Seat Back Panels

New pre-cut, pre-sewn vinyl and carpet front bucket seat back panels with new boards. These will help finish off your new upholstery.

Note: Special order; must be pre-paid. Please specify three digit carpet color code when ordering.

MA9022100	1965	black	171.99	pr
MA9022202	1965	pearl	171.99	pr
MA9022314	1965	blue	171.99	pr
MA9022520	1965	metallic red	171.99	pr
MA9022610	1965	fawn	171.99	pr



MA9122100S01

Vinyl Color Chart

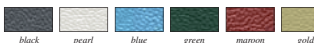

Carpet Color Chart

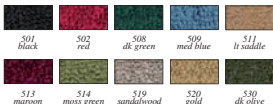

1968 Barracuda Deluxe Front Bucket Seat Back Panels

New fully carpeted front bucket seat back panels with vinyl bindings and new boards. These will help finish off your new upholstery.

Note: Special order; must be pre-paid. Please specify three digit carpet color code when ordering.

MA9122100	1968	black	115.99	pr
MA9122202	1968	pearl	115.99	pr
MA9122332	1968	blue	115.99	pr
MA9122430	1968	green	115.99	pr
MA9122526	1968	maroon	115.99	pr
MA9122636	1968	gold	115.99	pr



B-Body Seat Back Panels



MB9124100501

Vinyl Color Chart

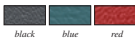

black blue red

Carpet Color Chart

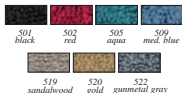

501 black 502 red 505 aqua 509 med. blue
519 sandalwood 520 gold 522 gunmetal gray

1963 Sport Fury Bucket Seat Back Panels

New pre-cut, pre-sewn vinyl and carpet front bucket seat back panels with new boards. Replacing these will help finish off your new upholstery.

Note: Special order, must be pre-paid. Please specify three digit carpet color code when ordering.

MB9124100	1963	black	171.99	pr
MB9124302	1963	blue	171.99	pr
MB9124510	1963	red	171.99	pr



MB9123204501



MB9123204502

Vinyl Color Chart



dark white

Carpet Color Chart

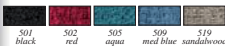

501 black 502 red 505 aqua 509 med blue 519 sandalwood

1963 Polara 500 Bucket Seat Back Panels

New pre-cut, pre-sewn vinyl and carpet front bucket seat back panels with new boards. Replacing these will help finish off your new upholstery.

Note: Special order, must be pre-paid. Please specify three digit carpet color code when ordering.

MB9123204	1963	dark white	171.99	pr
-----------	------	------------	-------	--------	----



Made in USA



MB46416

Carpet Color Chart

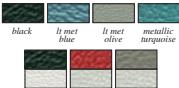

black lt met blue lt met olive metallic turquoise
black w/silver accent crimson red w/pearl accent fawn w/pearl accent

1964 Polara 500 Bucket Seat Back Panels

Install these new pre-cut, pre-sewn vinyl front bucket seat back trim panels with new boards to finish off your new upholstery. Made in USA.

*Note: *No further discounts apply on special run material.*

MB46100	1964	black	161.99	pr
MB46101	1964	black w/silver accent	161.99	pr
MB46314	1964	light metallic blue	161.99	pr
MB46410*	1964	light metallic olive	259.99	pr
MB46416	1964	metallic turquoise	161.99	pr
MB46511	1964	red w/pearl accent	161.99	pr
MB46610	1964	fawn w/pearl accent	161.99	pr



MB9221100501

Vinyl Color Chart



black lt met blue met turq red copper

Carpet Color Chart

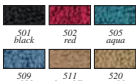

501 black 502 red 505 aqua
509 med blue 511 lt saddle 520 gold

1964 Sport Fury Bucket Seat Back Panels

New pre-cut, pre-sewn vinyl and carpet front bucket seat back panels with new boards. Replacing these will help finish off your new upholstery.

Note: Special order, must be pre-paid. Please specify three digit carpet color code when ordering.

MB9221100	1964	black	171.99	pr
MB9221318	1964	lt met blue	171.99	pr
MB9221416	1964	met turquoise	171.99	pr
MB9221510	1964	red	171.99	pr
MB9221606	1964	copper	171.99	pr



MB9122100501



MB9122100505



MB9122520513



MB9122610519

Vinyl Color Chart



black pearl met blue



met turq met red met fawn

Carpet Color Chart

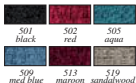

501 black 502 red 505 aqua
509 med blue 513 maroon 519 sandalwood

1965 Coronet 500 Bucket Seat Back Panels

New pre-cut, pre-sewn vinyl and carpet front bucket seat back panels with new boards. Replacing these will help finish off your new upholstery.

Note: Special order, must be pre-paid. Please specify three digit carpet color code when ordering.

MB9122100	1965	black	171.99	pr
MB9122202	1965	pearl	171.99	pr
MB9122314	1965	met blue	171.99	pr
MB9122416	1965	met turquoise	171.99	pr
MB9122520	1965	met red	171.99	pr
MB9122610	1965	met fawn	171.99	pr

A INTERIOR COMPONENTS

B-Body Seat Back Panels



MB9020100

Vinyl Color Chart



black blue turquoise maroon gold

1965 Satellite Front Bucket Seat Back Panels

New pre-cut, pre-sewn vinyl front bucket seat back panels with new boards. These will help finish off your new upholstery.

Note: No farther discounts apply on NOS material.

MB9020100	1965	black	161.99
MB9020298	1965	black/med blue	161.99
MB9020314	1965	met blue	161.99
MB9020315	1965	med blue/met blue	161.99
MB9020405	1965	turquoise/dk turquoise	161.99
MB9020415	1965	dk met turquoise	161.99
MB9020416	1965	met turquoise	161.99
MB9020510	1965	crimson red	161.99
MB9020521	1965	maroon/crimson red	161.99
MB9020522	1965	crimson red/maroon	161.99
MB9020614	1965	gold	161.99
MB9020698*	1965	gold/drk met gold	252.99



MB9021100501

Vinyl Color Chart



black white navy
citron red gold

Carpet Color Chart



501 black 502 red 504 ivy gold 505 aqua 507 dk blue

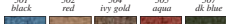

509 med blue 511 saddle 512 dk saddle 521 brnt orange 530 dk olive

1966 Coronet 500 Bucket Seat Back Panels

New pre-cut, pre-sewn vinyl and carpet front bucket seat back panels. Replacing these will help finish off your new upholstery. Specify color when ordering.

Note: Special orders must be pre-paid. Please specify three digit carpet color code when ordering.

MB9021100	1966	black	81.99
MB9021202	1966	pearl white	81.99
MB9021320	1966	metallic navy	81.99
MB9021420	1966	citron	81.99
MB9021520	1966	metallic red	81.99
MB9021614	1966	gold	81.99



Made in USA



MOPAR PARTS AND ACCESSORIES



MB902320505

Vinyl Color Chart

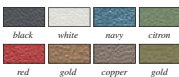

Carpet Color Chart

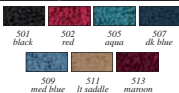

1966-67 Charger Bucket Seat Back Panels

New pre-cut, pre-sewn vinyl and carpet front bucket seat back panels. These will help finish off your new upholstery. Made in USA.

Note: Special orders must be pre-paid. Please specify three digit carpet color code when ordering.

Front Bucket Seats

MB9021100	1966-67	black	81.99
MB9021202	1966-67	pearl white	81.99
MB9021320	1966-67	metallic navy	81.99
MB9021420	1966	citron	81.99
MB9021520	1966-67	metallic red	81.99
MB9021614	1966	gold	81.99
MB9022620	1967	copper	81.99
MB9022630	1967	gold	81.99



Made in USA



MOPAR PARTS AND ACCESSORIES



MB9121100501

Carpet Color Chart

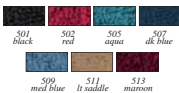

1966-67 Charger Bucket Seat Back Panels

New pre-cut, pre-sewn carpet rear bucket seat back panels. These will help finish off your new upholstery. Made in USA.

Note: Special order, must be pre-paid.

Rear Bucket Seats

MB9121501	1966-67	red	45.99
MB9121502	1966-67	black	45.99
MB9121505	1966-67	aqua	45.99
MB9121507	1966-67	dark blue	45.99
MB9121509	1966-67	medium blue	45.99
MB9121511	1967-67	light saddle	45.99
MB9121513	1967-67	maroon	45.99



MB9021100501



MB9021100502



MB9021320505



MB9021320507



MB9021630120

Vinyl Color Chart

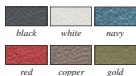

Carpet Color Chart



1967 Coronet R/T & 500 Bucket Seat Back Panels

New pre-cut, pre-sewn vinyl and carpet front bucket seat back panels. These will help finish off your new upholstery. Specify color when ordering.

Note: Special orders must be pre-paid. Please specify three digit carpet color code when ordering.

MB9021100	1967	black	81.99
MB9021202	1967	pearl white	81.99
MB9021320	1967	metallic navy	81.99
MB9021520	1967	metallic red	81.99
MB9021620	1967	copper	81.99
MB9021630	1967	gold	81.99

Seat Belt Components



Universal Fit Bucket Seat Belts

The closest thing to a factory installed seat belt yet! These aftermarket seat belts are designed for an OE appearance without the high cost of OE. Unlike other seat belts which require assembly, these units are ready to bolt in and are available in 4 popular colors.

Note: Non-retractable type. Sold per seat (order 2 for both bucket seats). Not to be used in conjunction with factory shoulder harnesses. Not for use with bench seats or rear seats. Hardware and bolts for installation not included. DOT requires 3-point harness for 1973 and later models.

SB150	black	per seat	19.99	ea
SB152	maroon	per seat	19.99	ea
SB157	tan	per seat	19.99	ea
SB158	blue	per seat	19.99	ea



MB204101



1968-74 3 Point Retractable Seat Belts

Add a new level of safety to your Mopar with these high quality 3 point retractable seat belts. Complete with front lap and shoulder belts, retractors, all necessary stainless steel brackets, stainless steel hardware and installation instructions. Easily installs using factory seat belt mount holes and all brackets are designed to fit your floor pan's contours perfectly for a beautiful installation. Each seat belt is safety tested at the factory for safety and quality assurance. Fits 1968-74 A, B and E-Body vehicles.

Important: Seat belt extenders are available to allow these seat belts to be used with bench seat applications using the seat belts listed below only. The 15" extenders will add approximately 5" length to the belt. The 16" extenders will add approximately 6" in length. **Note:** Please add two digit color when ordering.

A-Body	MA2140	1968-74	all	334.99	pr
B-Body	MB2041	1968-74	all	334.99	pr
E-Body	ME2042	1970-74	all	334.99	pr
Seat Belt Extenders For Bench Seats	MD2040	15"		31.99	pr
	MD2041	16"		31.99	pr



MA687601



Made in USA

1964-70 A-Body & B-Body 3 Point Retractable Seat Belt Conversions

Want the added safety of a 3 point retractable seat belt in your 1964-70 A- or B-Body model. These 3 point retractable seat belts which feature the correct OE style lift latch buckles in your choice of either chrome or textured finish and are available in configurations for bucket seats or bench seats and come complete with all hardware and instructions. Bench seat belt sets include the center seat belt. These belts are tested by the manufacturer to ensure each seat belt meets government safety standards and maintain the highest quality. Each belt features the correct safety label pre-sewn into it. Made in the USA.

A-Body

Front Bench Seat with Center Belt - Chrome					
MA687601	1964-67	black	329.99	set	
MA687602	1964-67	flame red	329.99	set	
MA687612	1964-67	dark blue	329.99	set	
MA687635	1964-67	tan	329.99	set	
MA687613	1964-67	green	329.99	set	
Front Bucket Seat - Chrome					
MA687701	1964-67	black	319.99	pr	
MA687702	1964-67	flame red	319.99	pr	
MA687712	1964-67	dark blue	319.99	pr	
MA687735	1964-67	tan	319.99	pr	
MA687713	1964-67	green	319.99	pr	
Front Bench Seat with Center Belt - Black Textured					
MA687301	1968-70	black	334.99	set	
MA687302	1968-70	flame red	334.99	set	
MA687312	1968-70	dark blue	334.99	set	
MA687335	1968-70	tan	334.99	set	
MA687313	1968-70	green	334.99	set	
Front Bucket Seat - Black Textured					
MA687401	1968-70	black	324.99	pr	
MA687402	1968-70	flame red	324.99	pr	
MA687412	1968-70	dark blue	324.99	pr	
MA687435	1968-70	tan	324.99	pr	
MA687413	1968-70	green	324.99	pr	

B-Body

Front Bench Seat with Center Belt - Chrome					
MB173501	1964-67	black	329.99	set	
MB173502	1964-67	flame red	329.99	set	
MB173512	1964-67	dark blue	329.99	set	
MB173535	1964-67	tan	329.99	set	
MB173513	1964-67	green	329.99	set	
Front Bucket Seat - Chrome					
MB173601	1964-67	black	319.99	pr	
MB173602	1964-67	flame red	319.99	pr	
MB173612	1964-67	dark blue	319.99	pr	
MB173635	1964-67	tan	319.99	pr	
MB173613	1964-67	green	319.99	pr	
Front Bench Seat with Center Belt - Black Textured					
MB173701	1968-70	black	334.99	set	
MB173702	1968-70	flame red	334.99	set	
MB173712	1968-70	dark blue	334.99	set	
MB173735	1968-70	tan	334.99	set	
MB173713	1968-70	green	334.99	set	
Front Bucket Seat - Black Textured					
MB173801	1968-70	black	324.99	pr	
MB173802	1968-70	flame red	324.99	pr	
MB173812	1968-70	dark blue	324.99	pr	
MB173835	1968-70	tan	324.99	pr	
MB173813	1968-70	green	324.99	pr	

Seat Belt Components

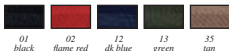

1964-70 Lift Latch Seat Belts

These aftermarket seat belts are designed for an OE front and fit without the high cost of OE. Unlike other seat belts that require assembly, these are ready to bolt in. Available in 5 factory colors and in configurations for bench and bucket seats. The front bench seat belts include the center passenger seat belt. Front seat belts are sold in pairs, rear belts are sold each. These belts are tested by the manufacturer to ensure each seat belt meets government safety standards and maintain the highest quality. Each belt features the correct safety label pre-sewn into it. Made in the USA.

*Note: *Includes center belt. Please add two digit color code when ordering.*

		A-Body	
Front Bench Seat			
MA6870*	1964-67	chrome.....	199.99 set
MA6871*	1968-70	black.....	244.99 set
Front Bucket Seat			
MA6875	1964-67	chrome.....	179.99 pr
MA6872	1968-70	black.....	229.99 pr
Rear Seat - 60" Long			
MD6467	1964-67	chrome.....	19.99 ea
MD6870	1968-70	black.....	24.99 ea
		B-Body	
Front Bench Seat			
MB1731*	1964-67	chrome.....	199.99 set
MB1733*	1968-70	black.....	244.99 set
Front Bucket Seat			
MB1732	1964-67	chrome.....	179.99 pr
MB1734	1968-70	black.....	229.99 pr
Rear Seat			
MD6467	1964-67	chrome.....	19.99 ea
MD6870	1968-70	black.....	24.99 ea



1960-76 Accessory Seat Belt Retractor

These seat belt retractors were a dealer option designed to be easily installed in applications not originally equipped with retractors, or as a replacement for worn or broken originals.

986068 1960-76..... 37.99 pr



1968-70 Seat Belt Retractor Covers

Factory-style replacement seat belt retractor covers for 1968-70 A and B-Body models. Manufactured from quality vinyl, these covers offer good looks and the flexibility to stand up to use. These are an excellent way to enhance the appearance of good condition seat belts even further. Available exclusively in black. Sold individually. Made in USA.

Note: Covers may be painted/dyed to your desired color.

		A-Body	
MA688000	1968-70	LH.....	24.99 ea
MA688001	1968-70	RH.....	24.99 ea
		B-Body	
MB173900	1968-70	LH.....	24.99 ea
MB173901	1968-70	RH.....	24.99 ea



1968-69 B-Body Seat Belt Clips

Reproduction seat belt retainer clips for 1968-69 B-Body models. Used to secure the shoulder belt to the roof near the sun visors when the belt is not in use. Manufactured from steel with the correct shape, contours and hole placement as original.

MB1501 1968-69..... 49.99 pr



1967-74 Shoulder Harness Mounting Covers

These front shoulder harness mounting covers will give your car the finishing touch, concealing the shoulder harness mounting bolts the way the factory intended. For 1967-70 A-Body models, 1967-70 B-Body models and 1970-74 E-Body Barracuda, Cuda and Challenger.

		A & B-Body	
MD159	1967-70	29.99 pr
		E-Body	
MD159	1970-74	29.99 pr



1970 E-Body Seat Belt Guide

Located in a very vulnerable position on the outside of the front seats, on top of the carpet, the original seat belt guides are prone to cracking from being stepped on. If yours are missing or cracked, these replacement guides are the answer. For 1970 E-Body vehicles. Includes mounting screws.

MS1572 1970..... 14.99 set



1967-70 Seat Belt Mounting Covers

Located on the tunnel where the seat belts attach to the floor, these black rubber mounting covers will give your car the finishing touch, concealing the seat belt mounting bolts to the way the factory intended. For 1967-70 A-Body and B-Body models.

MD160 1967-70 A & B-Body..... 31.99 pr



1970-74 E-Body Seat Belt Bolts

Reproduction seat belt mounting bolts for 1970-74 E-Body models. Specially designed and heat treated for seat belt attachment to the floor pan anchor plate.

ME1875 1970-74 hardtop..... 74.99 set
ME1876 1970-74 convertible..... 64.99 set



1968-69 Seat Belt Retaining Clip

Keep your seat belts in good condition and out of the way when not in use. Applications to fit 1968-69 A-Body models including Barracuda, Dart and Valiant and B-Body models including Belvedere, Charger, Coronet, GTX, Road Runner, Satellite and Super Bee. Available for bench or bucket seat models. Mounting screws are included.

Note: Please specify black or white when ordering.

		Front Seat Retainers	
MD116	1968-69	bucket seat models....	29.99 pr
MD117	1968-69	bench seat models....	29.99 pr
		Rear Seat Retainers	
MD117	1968-69	rear seat.....	29.99 pr
		Complete Set of Front and Rear Retainers	
MD118	1968-69	bucket seat models....	49.99 set
MD119	1968-69	bench seat models....	49.99 set

Legend
AUTO INTERIORS LTD.

Interior Door Panels

— DODGE & PLYMOUTH A-BODY • 1964-68 —

Made in USA



MA1025332

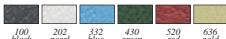

1968 Dart GT & Dart GTS Door Panels

Dielectrically heat-sealed Ascot grain door panels for a factory look and feel. Applications for front and rear of bucket seat equipped 1968 Dart GT and 1968 Dart GTS hardtop models and front of convertible models equipped with bucket seats. Made in USA.

Note: Please add 3 digit color code when ordering.

Front Panels

MA1025 1968 all colors 324.99 pr

Hardtop Rear Panels

MA1026 1968 all colors 186.99 pr



MA1027100

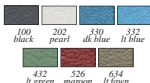

1968 Dart 270 & Super Stock Door Panels

Dielectrically heat-sealed Cologne grain door panels for a factory look and feel. Applications for front and rear of bench seat equipped 1968 Dart 270 2 door hardtop and bucket seat equipped 1968 Dart Super Stock models. Made in USA.

Note: Please add 3 digit color code when ordering.

Front Panels

MA1027 1968 all colors 324.99 pr

2 Door Hardtop Rear Panels

MA1028 1968 all colors 186.99 pr



MA1012614

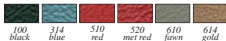

1964-65 Barracuda Fastback 1965 Valiant Signet Door Panels

Dielectrically heat-sealed Bison grain door panels with chrome accents for a factory look and feel. Applications for 1964-65 Barracuda fastback and 1965 Valiant Signet with bucket seats. Made in USA.

Note: Please add 3 digit color code when ordering.

1964-65 Barracuda fastback

MA1012 1964-65 front panels 354.99 pr

MA1013 1964-65 rear panels 201.99 pr

1965 Valiant Signet

MA1012 1965 front panels 354.99 pr

MA1014 1965 rear panels 161.99 pr



MA1015505

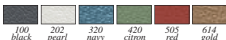

1966 Barracuda Fastback 1966 Valiant Signet Door Panels

Dielectrically heat-sealed Cologne grain door panels for a factory look and feel. Applications for front and rear of 1966 Barracuda fastback models and front of 1966 Valiant Signet equipped with bucket seats. Made in USA.

Note: Please add 3 digit color code when ordering.

Barracuda fastback

MA1015 1966 front panels 324.99 pr

MA1016 1966 rear panels 186.99 pr

Valiant Signet

MA1015 1966 front panels 324.99 pr



MA1017350



1967 Barracuda Door Panels

Dielectrically heat-sealed Cologne grain door panels for a factory look and feel. Applications for 1967 Barracuda noteback or fastback models with bucket seats. Made in USA.

Note: Please add 3 digit color code when ordering. *No further discounts apply.

Front Panels

MA1073* 1967 gold - NOS 496.99 pr

MA1073 1967 all other colors 324.99 pr

Noteback Rear Panels

MA1074* 1967 gold - NOS 281.99 pr

MA1074 1967 all other colors 186.99 pr

Fastback Rear Panels

MA1075* 1967 gold - NOS 281.99 pr

MA1075 1967 all other colors 186.99 pr



MA1017520



1967 Valiant Signet Door Panels

Dielectrically heat-sealed Cologne grain door panels with Bambo grain uppers for a factory look and feel. Fits 1967 Valiant Signet 2 door sedan with bench or bucket seating. Made in USA.

Note: Please add 3 digit color code when ordering.

Front Panels

MA1017 1967 brown/gold 614.99 pr

MA1017 1967 all other colors 324.99 pr

Sedan Rear Panels

MA1018 1967 brown/gold 349.99 pr

MA1018 1967 all other colors 186.99 pr



MA1019318



1967 "Canadian" Valiant Door Panels

Dielectrically heat-sealed Cologne grain door panels for a factory look and feel. Applications for models with standard bench seat upholstery including 1967 "Canadian" Valiant 2 door sedan. Made in USA.

Note: Please add 3 digit color code when ordering. *No further discounts apply.

Front Panels

MA1019* 1967 gold - NOS 496.99 pr

MA1019 1967 all other colors 324.99 pr

"Canadian" Valiant Sedan Rear Panels

MA1021* 1967 gold - NOS 256.99 pr

MA1021 1967 all other colors 186.99 pr



MA1076100



1968 Barracuda Standard Door Panels

Dielectrically heat-sealed Cologne grain door panels for a factory look and feel. Applications for 1968 Barracuda fastback or noteback models with standard upholstery. Made in USA.

Note: Please add 3 digit color code when ordering.

Front Panels

MA1076 1968 all colors 324.99 pr

Fastback Rear Panels

MA1078 1968 all colors 186.99 pr

Noteback Rear Panels

MA1077 1968 all colors 186.99 pr



MA1079526

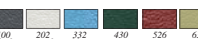

1968 Barracuda Deluxe Door Panels

Dielectrically heat-sealed Cologne grain door panels with woodgrain accents for a factory look and feel. Applications for 1968 Barracuda fastback or noteback models with deluxe upholstery. Made in USA.

Note: Please add 3 digit color code when ordering.

Front Panels

MA1079 1968 all colors 402.99 pr

Fastback Rear Panels

MA1081 1968 all colors 194.99 pr

Noteback Rear Panels

MA1080 1968 all colors 194.99 pr

Legendary
AUTO INTERIORS LTD.

Interior Door Panels

— DODGE & PLYMOUTH A-BODY • 1968-74 —



MA1022100

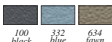

1968 Valiant Sedan Std Door Panels

Dielectrically heat-sealed Cologne grain door panels for a factory look and feel. Applications for models with standard bench seat upholstery including 1968 Valiant 100 2 door sedan. Made in USA.

Note: Please add 3 digit color code when ordering.

Front Panels

MA1022 1968 all colors.....	324.99 pr
Dart Sedan Rear Panels	
MA1023 1968 all colors.....	186.99 pr
Valiant Sedan Rear Panels	
MA1024 1968 all colors.....	186.99 pr



MA1082100



1969 Barracuda Standard Door Panels

Dielectrically heat-sealed Coachman grain door panels for a factory look and feel. Applications for 1969 Barracuda notchback or fastback models with standard upholstery. Made in USA.

Note: Please add 3 digit color code when ordering.

Front Panels

MA1082 1969 all colors.....	324.99 pr
Fastback Rear Panels	
MA1084 1969 all colors.....	186.99 pr
Notchback Rear Panels	
MA1083 1969 all colors.....	186.99 pr



MA1085434

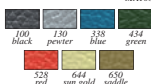

1969 Barracuda Deluxe Door Panels

Dielectrically heat-sealed Coachman grain door panels with woodgrain accents, chrome bands and a map pocket for a factory look and feel. Applications for 1969 Barracuda notchback or fastback models with deluxe bucket seat upholstery. Made in USA.

Note: Please add 3 digit color code when ordering.

Front Panels

MA1085 1969 all colors.....	357.99 pr
Fastback Rear Panels	
MA1087 1969 all colors.....	186.99 pr
Notchback Rear Panels	
MA1086 1969 all colors.....	186.99 pr



MA1031100

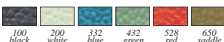

1969 Dart Custom Hardtop Door Panels

Dielectrically heat-sealed Coachman grain door panels for a factory look and feel. Applications for front and rear of 1969 Dart Custom 2 door hardtop with bench seat. Made in USA.

Note: Please add 3 digit color code when ordering.

Front Panels

MA1031 1969 all colors.....	324.99 pr
2 Door Hardtop Rear Panels	
MA1032 1969 all colors.....	186.99 pr



MA1033100

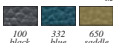

1969 Dart Swinger, Swinger 340

1969 Valiant 100 Door Panels

Dielectrically heat-sealed Coachman grain door panels for a factory look and feel. Applications for front and rear of bench seat equipped 1969 Dart Swinger, Swinger 340 and Valiant 100 2 door hardtop models. Made in USA.

Note: Please add 3 digit color code when ordering.

Front Panels

MA1033 1969 all colors.....	324.99 pr
Hardtop Rear Panels	
MA1034 1969 all colors.....	186.99 pr



MA1029332



MA1029507

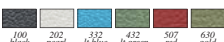

1969 Dart GT Door Panels

Dielectrically heat-sealed Dakota grain door panels for a factory look and feel. Applications for front and rear of bucket seat equipped 1969 Dart GT hardtop models and front of bucket seat equipped convertible models. Made in USA.

Note: Please add 3 digit color code when ordering.

Front Panels

MA1029 1969 all colors.....	324.99 pr
Hardtop Rear Panels	
MA1030 1969 all colors.....	186.99 pr



MA1033100



1970 Dart Swinger, Swinger 340

Dielectrically heat-sealed Coachman grain door panels for a factory look and feel. Applications for front and rear of bench seat equipped 1970 Dart Swinger and Swinger 340 hardtop. Made in USA.

Note: Please add 3 digit color code when ordering.

Front Panels

MA1033 1970 all colors.....	324.99 pr
Hardtop Rear Panels	
MA1034 1970 all colors.....	186.99 pr



MA1053100 - standard panel



MA1055

MA1056

w/chrome accent

w/woodgrain accent

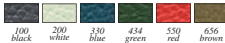

1970 Duster & Duster 340 Door Panels

Dielectrically heat-sealed Coachman grain door panels for a factory look and feel. Applications for front and rear of 1970 Duster and Duster 340. Made in USA.

Note: Please add 3 digit color code when ordering.

Front Panels

MA1053 1970 standard.....	324.39 pr
MA1055 1970 w/chrome accent.....	339.99 pr
MA1056 1970 w/woodgrain accent.....	339.99 pr
Rear Panels	
MA1054 1970 all colors.....	186.99 pr



MA1053332

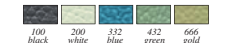

1971 Dart Swinger, Valiant Scamp Door Panels

Dielectrically heat-sealed Coachman grain door panels for a factory look and feel. Applications for front and rear of 1971 Dart Swinger and 1971 Valiant Scamp 2 door hardtop models with bucket seats or bench seat. Made in USA.

Note: Please add 3 digit color code when ordering.

Front Panels

MA1035 1971 all colors.....	324.99 pr
Hardtop Rear Panels	
MA1036 1971 all colors.....	186.99 pr

Legendary
AUTO INTERIORS LTD.

Interior Door Panels

— DODGE & PLYMOUTH A-BODY • 1971-75 —



standard panel

MA1057100



deluxe panel

MA1059100



1971 Demon & Duster Door Panels

Dielectrically heat-sealed Coachman grain door panels for a factory look and feel. Applications for front and rear of 1971 Demon, Demon 340, Duster and Duster 340 models. Made in USA.

Note: Please add 3 digit color code when ordering.

Front Panels

MA1057 1971 standard..... 307.99 pr
MA1059 1971 deluxe..... 339.99 pr

Rear Panels

MA1058 1971 standard..... 169.99 pr
MA1060 1971 deluxe..... 186.99 pr



MA1043700



MA1037340

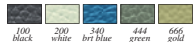

1972 A-Body Standard Door Panels

Dielectrically heat-sealed Coachman grain door panels for a factory look and feel. Made in USA.

Note: Please add 3 digit color code when ordering.

1972 Dart Swinger, Valiant Scamp

Applications for front and rear of 1972 Dart Swinger and 1972 Valiant Scamp 2 door hardtop models equipped with bench seat.

Front Panels
MA1037 1972 all colors..... 324.99 pr

Hardtop Rear Panels

MA1038 1972 all colors..... 186.99 pr

1972 Demon, Duster

Applications for front and rear of 1972 Demon, Demon 340, Duster and Duster 340 models.

Front Panels
MA1037 1972 all colors..... 324.99 pr

Rear Panels

MA1061 1972 all colors..... 186.99 pr

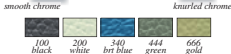

1972 A-Body Deluxe Door Panels

Dielectrically heat-sealed Coachman grain door panels with woodgrain accents and your choice of smooth or knurled chrome bands for a factory look and feel. Made in USA.

Note: Please add 3 digit color code when ordering.

1972 Dart Swinger, Valiant Scamp

Fits front and rear of 1972 Dart Swinger and 1972 Valiant Scamp 2 door hardtop models equipped with bench seat.

Front Panels

MA1039 1972 smooth chrome bands 339.99 pr
MA1041 1972 knurled chrome bands 339.99 pr

Hardtop Rear Panels

MA1040 1972 smooth chrome bands 194.99 pr
MA1042 1972 knurled chrome bands 194.99 pr

1972 Demon, Duster

Fits front and rear of 1972 Demon, Demon 340, Duster, Duster 340 models.

Front Panels

MA1039 1972 smooth chrome bands 339.99 pr
MA1041 1972 knurled chrome bands 339.99 pr

Rear Panels

MA1062 1972 smooth chrome bands 194.99 pr
MA1063 1972 knurled chrome bands 194.99 pr



MA1045100

1973 A-Body Deluxe Door Panels

Dielectrically heat-sealed Coachman grain door panels with woodgrain accents and chrome bands for a factory look and feel. Made in USA.

*Note: Please add 3 digit color code when ordering. *No further discounts apply.*

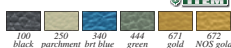

1973 Dart Swinger, Valiant Scamp

Fits front and rear of 1973 Dart Swinger and 1973 Valiant Scamp 2 door hardtop models equipped with bench seat.

Front Panels

MA1045* 1973 gold - NOS..... 599.99 pr
MA1045 1973 all other colors..... 354.99 pr

Hardtop Rear Panels

MA1046* 1973 gold - NOS..... 372.99 pr
MA1046 1973 all other colors..... 201.99 pr

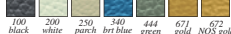

1973 Dart Sport, Duster

Fits front and rear of 1973 Dart Sport and Duster.

Front Panels

MA1045* 1973 gold - NOS..... 599.99 pr
MA1045 1973 all other colors..... 354.99 pr

Rear Panels

MA1065* 1973 gold - NOS..... 372.99 pr
MA1065 1973 all other colors..... 201.99 pr



MA1043671

1973 A-Body Standard Door Panels

Dielectrically heat-sealed Coachman grain door panels for a factory look and feel. Made in USA.

Note: Please add 3 digit color code when ordering.



1973 Dart Swinger, Valiant Scamp

Applications for front and rear of 1973 Dart Swinger and 1973 Valiant Scamp 2 door hardtop models equipped with bench seat.

*Note: *No further discounts apply.*

Front Panels

MA1043* 1973 gold - NOS..... 622.99 pr
MA1043 1973 all other colors..... 324.99 pr

Hardtop Rear Panels

MA1044* 1973 gold - NOS..... 391.99 pr
MA1044 1973 all other colors..... 186.99 pr

1973 Dart Sport, Duster

Applications for front and rear of 1973 Dart Sport and 1973 Duster equipped with bench seat.

*Note: *No further discounts apply.*

Front Panels

MA1043* 1973 gold - NOS..... 622.99 pr
MA1043 1973 all other colors..... 324.99 pr

Rear Panels

MA1064* 1973 gold - NOS..... 391.99 pr
MA1064 1973 all other colors..... 186.99 pr

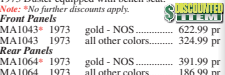

MA1070800

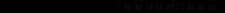
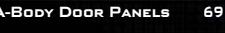
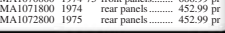
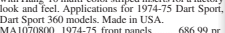
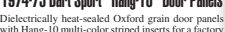
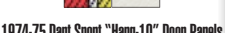
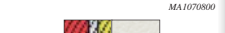

Classic
AUTO INTERIORS LTD.

Interior Door Panels

— DODGE & PLYMOUTH A-BODY • 1974-76 —



MA1050/100

1974-76 A-Body Deluxe Door Panels

Dielectrically heat-sealed Oxford grain door panels for a factory look and feel. Made in USA.

Note: Please add 3 digit color code when ordering.



MA1510/100

1974-76 A-Body Deluxe Bucket & Bench Door Panels

Dielectrically heat-sealed Oxford grain door panels for a factory look and feel. Made in USA.

Note: Please add 3 digit color code when ordering.

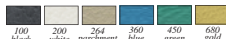

1974-76 A-Body Standard Door Panels

Dielectrically heat-sealed Oxford grain door panels for a factory look and feel. Made in USA.

Note: Please add 3 digit color code when ordering.

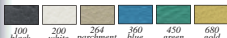

1974 Dart Swinger, Valiant Scamp

Applications for front and rear of 1974 Dart Swinger and 1974 Valiant Scamp 2-door hardtop models equipped with bench seat.

Note: No further discounts apply.

Front Panels	
MA1047 1974	parchment - NOS... 622.99 pr
MA1047* 1974	gold - NOS... 551.99 pr
MA1047 1974	all other colors... 324.99 pr

Hardtop Rear Panels

MA1048* 1974	parchment - NOS... 391.99 pr
MA1048* 1974	gold - NOS... 381.99 pr
MA1048 1974	all other colors... 186.99 pr

1974 Dart Sport, Duster, Duster 360

Applications for front and rear of 1974 Dart Sport, Duster and Duster 360 models.

Note: No further discounts apply.

Front Panels	
MA1047 1974	parchment - NOS... 622.99 pr
MA1047* 1974	gold - NOS... 551.99 pr
MA1047 1974	all other colors... 324.99 pr

Hardtop Rear Panels

MA1066* 1974	parchment - NOS... 391.99 pr
MA1066* 1974	gold - NOS... 381.99 pr
MA1066 1974	all other colors... 186.99 pr

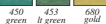

1975-76 Dart Swinger, Valiant Scamp

Applications for front and rear of 1975-76 Dart Swinger and Valiant Scamp 2-door hardtop models equipped with bench seat.

Note: No further discounts apply.

Front Panels	
MA1047* 1975-76	parchment - NOS... 622.99 pr
MA1047* 1975-76	gold - NOS... 551.99 pr
MA1047* 1975-76	light green - NOS... 551.99 pr
MA1047 1975-76	all other colors... 324.99 pr

Hardtop Rear Panels

MA1049* 1975-76	parchment - NOS... 391.99 pr
MA1049* 1975-76	gold - NOS... 381.99 pr
MA1049* 1975-76	light green - NOS... 381.99 pr
MA1049 1975-76	all other colors... 186.99 pr

1975-76 Dart Sport, Duster

Applications for front and rear of 1975-76 Dart Sport, Duster, Duster 360 models.

Note: No further discounts apply.

Front Panels	
MA1047* 1975-76	parchment - NOS... 622.99 pr
MA1047* 1975-76	gold - NOS... 551.99 pr
MA1047* 1975-76	light green - NOS... 551.99 pr
MA1047 1975-76	all other colors... 324.99 pr

Hardtop Rear Panels

MA1067* 1975-76	parchment - NOS... 391.99 pr
MA1067* 1975-76	gold - NOS... 381.99 pr
MA1067* 1975-76	light green - NOS... 381.99 pr
MA1067 1975-76	all other colors... 186.99 pr

1974 Dart Swinger, Valiant Scamp

Applications for front and rear of 1974 Dart Swinger and 1974 Valiant Scamp 2-door hardtop models equipped with bench seat.

Note: No further discounts apply.

Front Panels	
MA1050* 1974	parchment - NOS... 616.99 pr
MA1050* 1974	gold - NOS... 599.99 pr
MA1050 1974	all other colors... 354.99 pr

Hardtop Rear Panels

MA1051* 1974	parchment - NOS... 374.99 pr
MA1051* 1974	gold - NOS... 364.99 pr
MA1051 1974	all other colors... 201.99 pr

1974 Dart Sport, Duster, Duster 360

Applications for front and rear of 1974 Dart Sport, Duster, Duster 360 models.

Note: No further discounts apply.

Front Panels	
MA1050* 1974	parchment - NOS... 616.99 pr
MA1050* 1974	gold - NOS... 599.99 pr
MA1050 1974	all other colors... 354.99 pr

Hardtop Rear Panels

MA1068* 1974	parchment - NOS... 374.99 pr
MA1068* 1974	gold - NOS... 364.99 pr
MA1068 1974	all other colors... 201.99 pr

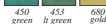

1975-76 Dart Swinger, Valiant Scamp

Applications for front and rear of 1975-76 Dart Swinger and Valiant Scamp 2-door hardtop models equipped with bench seat.

Note: No further discounts apply.

Front Panels	
MA1050* 1975-76	parchment - NOS... 616.99 pr
MA1050* 1975-76	gold - NOS... 599.99 pr
MA1050* 1975-76	light green - NOS... 551.99 pr
MA1050 1975-76	all other colors... 354.99 pr

Hardtop Rear Panels

MA1052* 1975-76	parchment - NOS... 374.99 pr
MA1052* 1975-76	gold - NOS... 364.99 pr
MA1052* 1975-76	light green - NOS... 381.99 pr
MA1052 1975-76	all other colors... 201.99 pr

1975-76 Dart Sport, Duster

Applications for front and rear of 1975-76 Dart Sport, Duster, Duster 360 models.

Note: No further discounts apply.

Front Panels	
MA1050* 1975-76	parchment - NOS... 616.99 pr
MA1050* 1975-76	gold - NOS... 599.99 pr
MA1050* 1975-76	light green - NOS... 551.99 pr
MA1050 1975-76	all other colors... 354.99 pr

Hardtop Rear Panels

MA1069* 1975-76	parchment - NOS... 374.99 pr
MA1069* 1975-76	gold - NOS... 364.99 pr
MA1069 1975-76	all other colors... 201.99 pr

1974 Dart Sport, Duster, Duster 360

Applications for front and rear of 1974 Dart Sport and 1974 Duster, Duster 360 2-door hardtop models equipped with bench seat.

Note: No further discounts apply.

Front Panels	
MA1150* 1974	parchment - NOS... 657.99 pr
MA1150* 1974	gold - NOS... 639.99 pr
MA1150 1974	all other colors... 354.99 pr

Hardtop Rear Panels

MA1151* 1974	parchment - NOS... 391.99 pr
MA1151* 1974	gold - NOS... 381.99 pr
MA1151 1974	all other colors... 186.99 pr



1975-76 Dart Sport, Duster, Duster 360

Applications for front and rear of 1975-76 Dart Sport, Duster, Duster 360 2-door hardtop models equipped with bench or bucket seat.

Note: No further discounts apply.

Front Panels	
MA1150* 1975-76	parchment - NOS... 657.99 pr
MA1150* 1975-76	gold - NOS... 639.99 pr
MA1150* 1975-76	light green - NOS... 639.99 pr
MA1150 1975-76	all other colors... 354.99 pr

Hardtop Rear Panels

MA1152* 1975-76	parchment - NOS... 391.99 pr
MA1152* 1975-76	gold - NOS... 381.99 pr
MA1152* 1975-76	light green - NOS... 381.99 pr
MA1152 1975-76	all other colors... 186.99 pr



Interior Door Panels

— DODGE & PLYMOUTH B-BODY • 1963-64 —



MB1005117501

Vinyl Color Chart

black/NOS copper blue/lt blue red/dk white

Carpet Color Chart

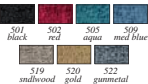

1963 Sport Fury Door Panels

Dielectrically heat-sealed Pinpoint grain upper with Bison grain center and carpeted lower section for a factory look and feel. Applications for front and rear of 1963 Sport Fury hardtop or convertible. Made in the lower portion of the panel is carpeted. Made in USA.

Important: Must reuse original metal trim.
Note: Special order, must be pre-paid. Please add 3 digit color code when ordering.

*No further discounts apply.

Front Panels

MB1005305 1963 blue/light blue..... 509.99 pr
MB1005513 1963 red/dark white..... 509.99 pr
MB1005117* 1963 blk/copper - NOS... 622.99 pr

Hardtop Rear Panels

MB1006305 1963 blue/light blue..... 226.99 pr
MB1006513 1963 red/dark white..... 226.99 pr
MB1006117* 1963 blk/copper - NOS... 302.99 pr

Convertible Rear Panels (without Rear Armrest)

MB1007305 1963 blue/light blue..... 194.99 pr
MB1007513 1963 red/dark white..... 194.99 pr
MB1007117* 1963 blk/copper - NOS... 251.99 pr

Convertible Rear Panels (with Rear Armrest)

MB1008305 1963 blue/light blue..... 194.99 pr
MB1008513 1963 red/dark white..... 194.99 pr
MB1008117* 1963 blk/copper - NOS... 251.99 pr



MB1012422



1964 Fury Door Panels

Dielectrically heat-sealed Bison grain panels for a factory look and feel. Fits front and rear of bench seat equipped 1964 Fury hardtop or convertible. Available in a variety of factory colors to match your upholstery. Metal accent trim not included. Made in USA.

Important: Must reuse original metal trim.
Note: Please add 3 digit color code when ordering

Front Panels

MB1012 1964 all colors..... 495.99 pr
Hardtop Rear Panels
MB1013 1964 all colors..... 217.99 pr

Convertible Rear Panels

MB1014 1964 all colors..... 186.99 pr



MB1009100



MB1009511



MB1009609

Vinyl Color Chart

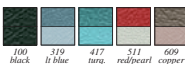

1964 Sport Fury Door Panels

Dielectrically heat-sealed Bison grain panels with chrome accents for a factory look and feel. Applications for front and rear of 1964 Sport Fury hardtop or convertible. Available in a variety of factory colors to match your upholstery. Made in USA.

Important: Must reuse original metal trim.
Note: *No further discounts apply.

Front Panels

MB1009100 1964 black..... 495.99 pr
MB1009319* 1964 light blue - NOS... 599.99 pr
MB1009417* 1964 turquoise - NOS... 599.99 pr
MB1009511 1964 red..... 495.99 pr
MB1009609* 1964 copper - NOS..... 599.99 pr

Hardtop Rear Panels

MB1010100 1964 black..... 217.99 pr
MB1010319* 1964 light blue - NOS... 285.99 pr
MB1010417* 1964 turquoise - NOS... 285.99 pr
MB1010511 1964 red..... 217.99 pr
MB1010609* 1964 copper - NOS..... 285.99 pr

Convertible Rear Panels

MB1011100 1964 black..... 186.99 pr
MB1011319* 1964 light blue - NOS... 244.99 pr
MB1011417* 1964 turquoise - NOS... 244.99 pr
MB1011511 1964 red..... 186.99 pr
MB1011609* 1964 copper - NOS..... 244.99 pr



MB1002511502

Vinyl Color Chart

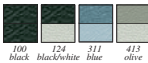

Carpet Color Chart



1964 Polara 500 Door Panels

Dielectrically heat-sealed Bison grain door panels with carpeted lower section for a factory look and feel. Applications for front and rear of 1964 Polara 500 hardtop or convertible. The lower portion of the panel is carpeted. Please add color code suffix to the part number and specify desired carpet color when ordering. Made in USA.

Important: Must reuse original metal trim.

Note: Special order, must be pre-paid. Please add 3 digit color code when ordering.
*No further discounts apply.

Front Panels

MB1002* 1964 blue - NOS..... 661.99 pr
MB1002* 1964 olive - NOS..... 716.99 pr
MB1002* 1964 turquoise - NOS..... 661.99 pr
MB1002 1964 all other colors..... 509.99 pr

Hardtop Rear Panels

MB1003* 1964 blue - NOS..... 331.99 pr
MB1003* 1964 olive - NOS..... 364.99 pr
MB1003* 1964 turquoise - NOS..... 331.99 pr
MB1003 1964 all other colors..... 226.99 pr

Convertible Rear Panels

MB1004* 1964 blue - NOS..... 267.99 pr
MB1004* 1964 olive - NOS..... 295.99 pr
MB1004* 1964 turquoise - NOS..... 267.99 pr
MB1004 1964 all other colors..... 226.99 pr



Door Panel Removal Tools

Unique tools designed to remove door panels and moldings from interior panels. Safe and easily remove the door panels in your classic Mopar with these specially designed tools!

Door Panel Removal Tool
Y35350 door panel remover..... 14.99 ea

Door Panel Trim Removal Tool
A7999 trim removal tool..... 9.99 ea

Legacy
AUTO INTERIORS LTD.

Interior Door Panels



— DODGE B-BODY • 1965-67 —



MB1092416

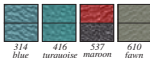

314 blue 416 turquoise 537 maroon 610 fawn

1965 Coronet 440 Door Panels

Dielectrically heat-sealed Bison grain panels with Ribbed center strip and chrome accents for a factory look and feel. Applications for front and rear of bench seat equipped 1965 Coronet 440 2 door hardtop or convertible. Made in USA.

Note: Please add 3 digit color code when ordering.

Front Panels	MB1092	1965	all colors	479.99	pr
Hardtop Rear Panels	MB1093	1965	all colors	211.99	pr
Convertible Rear Panels	MB1094	1965	all colors	179.99	pr



MB1095534

Vinyl Color Chart

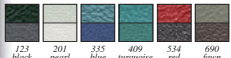

123 black 201 pearl 335 blue 409 turquoise 534 red 690 fawn

Carpet Color Chart

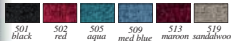

501 black 502 red 505 aqua 509 med blue 513 maroon 519 sandalwood

1965 Coronet 500 Panels

Dielectrically heat-sealed Bison grain with Record grain insert, chrome accents and carpeted lower section for a factory look and feel. Applications for front and rear of bucket seat equipped 1965 Coronet 500 hardtop or convertible. The lower portion of the panel is carpeted. Made in USA.

Important: Must reuse original metal trim.

Note: Special order; must be pre-paid. Please add 3 digit color code when ordering.

No further discounts apply.



Front Panels	MB1095*	1965	fawn - NOS	747.99	pr
	MB1095	1965	all other colors	671.99	pr
Hardtop Rear Panels	MB1096*	1965	fawn - NOS	275.99	pr
	MB1096	1965	all other colors	226.99	pr
Convertible Rear Panel	MB1097*	1965	fawn - NOS	244.99	pr
	MB1097	1965	all other colors	194.99	pr



MB1101100



MB1101629

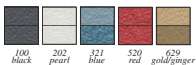

100 black 202 pearl 321 blue 520 red 629 gold/ginger

1966 Coronet 440 Door Panels

Dielectrically heat-sealed Bedford grain upper with Cologne grain lower section and chrome accents for a factory look and feel. Applications for front and rear of bench seat equipped 1966 Coronet 440 2 door hardtop or convertible. Available in a variety of factory colors to match your upholstery. Made in USA.

Note: Please add 3 digit color code when ordering.

Front Panels	MB1101	1966	gold	571.99	pr
	MB1101	1966	all other colors	354.99	pr
Hardtop Rear Panels	MB1102	1966	gold	344.99	pr
	MB1102	1966	all other colors	201.99	pr
Convertible Rear Panel	MB1103	1966	blue	191.99	pr
	MB1103	1966	all other colors	124.99	pr



MB109820501

Vinyl Color Chart

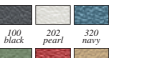

100 black 202 pearl 320 navy



420 citron 520 red 614 gold

Carpet Color Chart



501 black 502 red 504 ivy gold 505 aqua 507 dk blue 509 med blue 511 saddle brnt org 521 dk olive 530

1966 Coronet 500 Door Panels

Dielectrically heat-sealed Cologne grain panels with carpeted lower section for a factory look and feel. Applications for front and rear of bucket seat equipped 1966 Coronet 500 2 door hardtop or convertible. Includes pre-installed carpet on the lower portion of the door panels. Made in USA.

Note: Special order; must be pre-paid. Please add 3 digit color code when ordering.

Front Panels	MB1098	1966	front panels	339.99	pr
	MB1099	1966	hardtop rear panels	194.99	pr
	MB1100	1966	convertible rear panel	124.99	pr



MB1104100501



MB1104202501



MB1104320509



MB1104520502

Vinyl Color Chart - Front Panels



100 black 202 pearl 320 navy 520 red 602 copper 630 gold

Carpet Color Chart - Front Panels

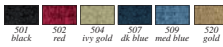

501 black 502 red 504 ivy gold 507 dk blue 509 med blue 520 gold

Vinyl Color Chart - Rear Panels

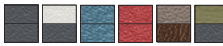

100 black 203 pearl/blk 320 navy 520 red 641 copper 647 gold

1967 Coronet 500 & Coronet R/T

Dielectrically heat-sealed Cologne grain front panels with carpeted lower section and rear panels with vinyl lower section for a factory look and feel. Applications for front and rear of bucket seat equipped 1967 Coronet 500 & Coronet R/T 2 door hardtop or convertible. Available in a variety of factory colors to match your upholstery. Metal trim not included. Made in USA.

Important: Must reuse original metal trim.

Note: Special order; must be pre-paid. Please add 3 digit color code when ordering.

Front Panels	MB1104	1967	all colors	339.99	pr
Hardtop Rear Panels	MB1105	1967	copper	194.99	pr
	MB1105	1967	all other colors	194.99	pr
Convertible Rear Panel	MB1106	1967	copper	161.99	pr
	MB1106	1967	all other colors	124.99	pr

A INTERIOR COMPONENTS

Legendary
AUTO INTERIORS LTD.

Interior Door Panels

— PLYMOUTH B-BODY • 1965-67 —



MB1015415

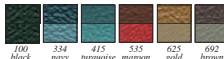

100 black 334 navy 415 turquoise 535 maroon 625 gold 692 brown

1965 Belvedere II Door Panels

Dielectrically heat-sealed Bison grain panels for a factory look and feel. Applications for bench seat equipped 1965 Belvedere II 2 door hardtop or convertible. Made in USA.

Important: Must reuse original metal trim.

Note: Please add 3 digit color code when ordering.

*No further discounts apply.

Front Panels	1965	gold - NOS	604.99 pr
MB1015*	1965	brown - NOS	604.99 pr
MB1015	1965	all other colors	495.99 pr

Hardtop Rear Panels	1965	gold - NOS	305.99 pr
MB1016*	1965	brown - NOS	305.99 pr
MB1016	1965	all other colors	217.99 pr

Convertible Rear Panels	1965	all other colors	186.99 pr
MB1017	1965	all other colors	186.99 pr



MB1021415

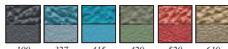

100 black 327 blue 415 turquoise 429 green 520 red 619 gold

1966 Belvedere II Door Panels

Dielectrically heat-sealed Cologne grain panels with Crator grain inserts for a factory look and feel. Applications for front and rear of bench seat equipped 1966 Belvedere II 2 door hardtop or convertible. Available in a variety of factory colors to match your upholstery. Made in USA.

Note: Please add 3 digit color code when ordering.

*No further discounts apply.

Front Panels	1966	gold - NOS	459.99 pr
MB1021	1966	all other colors	339.99 pr

Hardtop Rear Panels	1966	gold - NOS	272.99 pr
MB1022	1966	all other colors	194.99 pr

Convertible Rear Panel	1966	gold - NOS	181.99 pr
MB1023	1966	all other colors	124.99 pr



MB1032100

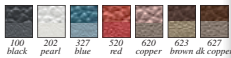

100 black 202 pearl 327 blue 520 red 620 copper 623 brown dk copper 627

1967 Belvedere II Door Panels

Dielectrically heat-sealed Cologne grain panels with Bambino grain inserts for a factory look and feel. Applications for front and rear of bench seat equipped 1967 Belvedere II 2 door hardtop or convertible. Available in a variety of factory colors to match your upholstery. Made in USA.

Note: Please add 3 digit color code when ordering.

*No further discounts apply.

Front Panels	1967	brown - NOS	511.99 pr
MB1032*	1967	dark copper - NOS	447.99 pr
MB1032	1967	all other colors	324.99 pr

Hardtop Rear Panels	1967	brown - NOS	315.99 pr
MB1033*	1967	dark copper - NOS	264.99 pr
MB1033	1967	all other colors	186.99 pr

Convertible Rear Panel	1967	dark copper - NOS	174.99 pr
MB1034*	1967	all other colors	116.99 pr



MB1018100



MB1018625

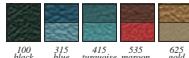

100 black 315 blue 415 turquoise 535 maroon 625 gold

1965 Satellite Door Panels

Dielectrically heat-sealed Bison grain panels for a factory look and feel. Applications for front and rear of bucket seat equipped 1965 Satellite 2 door hardtop or convertible. Available in a variety of factory colors to match your upholstery. Metal accent trim not included. Made in USA.

Important: Must reuse original metal trim.

Note: Please add 3 digit color code when ordering.

Front Panels	1965	gold - NOS	692.99 pr
MB1018*	1965	all other colors	495.99 pr

Hardtop Rear Panels	1965	gold - NOS	356.99 pr
MB1019*	1965	all other colors	217.99 pr

Convertible Rear Panels	1965	all other colors	217.99 pr
MB1020	1965	all other colors <td>217.99 pr</td>	217.99 pr



MB1024100



MB1024420

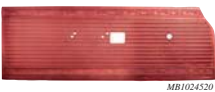

MB1024520

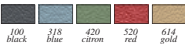

100 black 318 blue 420 citron 520 red 614 gold

1966 Satellite Vinyl Door Panels

Dielectrically heat-sealed Cologne grain panels with detailed horizontal Western Scroll inserts for a factory look and feel. Applications for front and rear of bucket seat equipped 1966 Satellite 2 door hardtop or convertible. Available in a variety of factory colors to match your upholstery. Made in USA.

Note: Please add 3 digit color code when ordering.

MB1024	1966	front panels	324.99 pr
MB1025	1966	hardtop rear panels	324.99 pr
MB1026	1966	convertible rear panel	116.99 pr



MB1027620

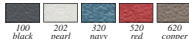

100 black 202 pearl 320 navy 520 red 620 copper

1967 Satellite & GTX Door Panels

Dielectrically heat-sealed Cologne grain panels with detailed vertical Western Scroll inserts for a factory look and feel. Fits front and rear of bucket seat equipped 1967 Satellite or GTX 2 door hardtop or convertible. Made in USA.

Note: Please add 3 digit color code when ordering.

MB1027	1967	all colors	324.99 pr
--------	------	------------	-----------

Hardtop Rear Panels	1967	all colors	186.99 pr
---------------------	------	------------	-----------

Convertible Rear Panel	1967	all colors	116.99 pr
------------------------	------	------------	-----------



MB1030107

1967 Belvedere II Silver Special

Dielectrically heat-sealed Cologne grain panels with Boar grain inserts for a factory look and feel. Applications for front and rear of bench seat equipped 1967 Belvedere II "Silver Special" 2 door hardtop. Made in USA.

Front Panels

MB1030107	1967	Silver Special	461.99 pr
-----------	------	----------------	-----------

Hardtop Rear Panels

MB1031107	1967	Silver Special	244.99 pr
-----------	------	----------------	-----------

Classic
CROWNLINE
AUTO INTERIORS LTD.

Interior Door Panels



— DODGE B-BODY • 1968-69 —



MB1107332

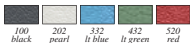

1968 Coronet 440 & Super Bee

Dielectrically heat-sealed Cologne grain panels for a factory look and feel. Fits front and rear of bench seat equipped 1968 Coronet 440 or Super Bee 2 door hardtop. Made in USA.

Note: Please add 3 digit color code when ordering.

Front Panels

MB1107 1968 all colors..... 324.99 pr

Rear Panels

MB1108 1968 all colors..... 186.99 pr



MB1109526

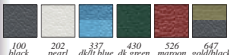

1968 Coronet R/T & Coronet 500

Dielectrically heat-sealed Cologne grain panels for a factory look and feel. Fits front and rear of bucket seat equipped 1968 Coronet R/T or Coronet 500 2 door hardtop or convertible. Made in USA.

Note: Please add 3 digit color code when ordering.

MB1109 1968 front panels..... 324.99 pr

MB1110 1968 hardtop rear panels..... 186.99 pr

MB1112 1968 convertible rear panel..... 116.99 pr



MB1041105

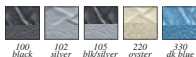

1968 Coronet Deluxe Door Panels

Dielectrically heat-sealed Cologne grain panels with Reed grain inserts for a factory look and feel. Fits front and rear of bench seat equipped 1968 Coronet 2 door hardtop with Deluxe upholstery. Made in USA.

Note: Please add 3 digit color code when ordering.

Front Panels

MB1041 1968 oyster..... 511.99 pr

MB1041 1968 all other colors..... 339.99 pr

Hardtop Rear Panels

MB1042 1968 oyster..... 194.99 pr

MB1042 1968 all other colors..... 194.99 pr



MB1116100



MB1116528



MB1116650

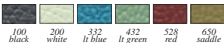

1969 Coronet 440 & Super Bee Door Panels

Dielectrically heat-sealed Coachman grain panels with heat-sealed Dodge Emblem for a factory look and feel. Applications for front and rear of bench seat equipped 1969 Coronet 440 or Super Bee. Available in a variety of factory colors to match your upholstery. Made in USA.

Note: Please add 3 digit color code when ordering.

MB1116 1969 front panels..... 354.99 pr

MB1117 1969 hardtop rear panels..... 186.99 pr



MB1113100



MB1113330

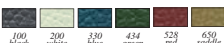

1969 Coronet 500, Coronet R/T & Super Bee

Dielectrically heat-sealed Coachman grain panels for a factory look and feel. Applications for front and rear of 1969 Coronet 500, Coronet R/T or Super Bee 2 door hardtops with bucket seats and convertibles with bench seat. Available in a variety of factory colors to match your upholstery. Made in USA.

Note: Please add 3 digit color code when ordering.

MB1113 1969 front panels..... 324.99 pr

MB1114 1969 hardtop rear panels..... 186.99 pr

MB1115 1969 convertible rear panels..... 116.99 pr



MB1069202



MB1069332

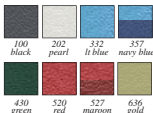

1969 Charger, Charger R/T Door Panels

Dielectrically heat-sealed Cologne grain panels with map pocket for a factory look and feel. Applications for front and rear of bucket seat equipped 1968 Charger or Charger R/T. Available in a variety of factory colors to match your upholstery. Made in USA.

Note: Please add 3 digit color code when ordering.

Front Panels

MB1069 1968 all colors..... 364.99 pr

Rear Panels

MB1070 1968 all colors..... 186.99 pr



MB1071200



MB1071670

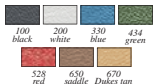

1969 Charger, Charger 500, R/T, SE & Daytona

Dielectrically heat-sealed Cologne grain panels with map pocket for a factory look and feel. Applications for front and rear of 1969 Charger, Charger 500, Charger R/T, Charger SE or Daytona. Made in USA.

*Important: *Dukes of Hazzard tan is a pre-paid, non-returnable special order only.*

Note: Please add 3 digit color code when ordering.

Front Panels

MB1071 * 1969 Dukes of Hazzard tan... 387.99 pr

MB1071 1969 all other colors..... 364.99 pr

Rear Panels

MB1072 * 1969 Dukes of Hazzard tan... 186.99 pr

MB1072 1969 all other colors..... 186.99 pr

A INTERIOR COMPONENTS

Legend
AUTO INTERIORS LTD.

Interior Door Panels

— PLYMOUTH B-BODY • 1968-69 —



MB1041105



MB1041330

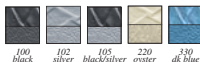

1968 Belvedere & Road Runner

Dielectrically heat-sealed Cologne grain panels with Reed grain inserts for a factory look and feel. Applications for front and rear of bench seat equipped 1968 Belvedere or Road Runner 2 door hardtop. Available in a variety of factory colors to match your upholstery. Made in USA.

Note: Please add 3 digit color code when ordering.

Front Panels

MB1041 1968 oyster 511.99 pr
MB1041 1968 all colors 339.99 pr

Hardtop Rear Panels

MB1042 1968 oyster 194.99 pr
MB1042 1968 all colors 194.99 pr



MB1043100



MB1043332



MB1043650

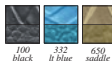

1969 Belvedere & Road Runner

Dielectrically heat-sealed Coachman grain panels with Reed grain inserts for a factory look and feel. Applications for front and rear of bench seat equipped 1969 Belvedere or Road Runner 2 door hardtop with Deluxe or Standard upholstery. Available in a variety of factory colors to match your upholstery. Made in USA.

Note: Please add 3 digit color code when ordering.

Front Panels

MB1043 1969 all colors 337.99 pr

Hardtop Rear Panels

MB1044 1969 all colors 185.99 pr



MB1038100



MB1038529

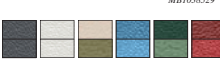

1968 Satellite & Road Runner w/Decor

Dielectrically heat-sealed Cologne grain panels for a factory look and feel. Applications for front and rear of "Decor" bench seat equipped 1968 Satellite or Road Runner 2 door hardtop or convertible. Pearl white, parchment/gold and gold/parchment rear panels are not offered for convertible models. Made in USA.

Note: Please add 3 digit color code when ordering.

**No further discounts apply on NOS material.*

Front Panels

MB1038* 1968 parch insert w/gold 461.99 pr
MB1038 1968 all other colors 339.99 pr

Hardtop Rear Panels

MB1039* 1968 parch insert w/gold 264.99 pr
MB1039 1968 all other colors 194.99 pr

Convertible Rear Panels

MB1040 1968 all colors 124.99 pr



MB1048651

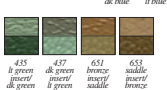
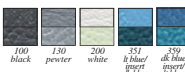

1969 Satellite & Road Runner Door Panels

Dielectrically heat-sealed Ascot grain inserts with Coachman grain panels for a factory look and feel. Applications for front and rear of bucket seat or "Decor" bench seat equipped 1969 Satellite or Road Runner 2 door hardtop or convertible. Available in a variety of factory colors to match your upholstery. Made in USA.

Note: Please add 3 digit color code when ordering.

MB1048 1969 front panels 339.99 pr

MB1049 1969 hardtop rear panels 194.99 pr

MB1050 1969 convertible panels 124.99 pr



MB1035526



MB1035630

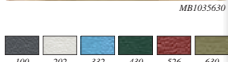

1968 Sport Satellite & GTX Door Panels

Dielectrically heat-sealed Cologne grain panels with woodgrain inserts for a factory look and feel. Applications for front and rear of bucket seat equipped 1968 Satellite or GTX 2 door hardtop or convertible. Available in a variety of factory colors to match your upholstery. Metal trim not included. Made in USA.

Important: Must reuse original metal trim.

Note: Please add 3 digit color code when ordering.

MB1035 1968 front panels 339.99 pr

MB1036 1968 hardtop rear panels 194.99 pr

MB1037 1968 convertible rear panels 124.99 pr



MB1045100



MB1045434

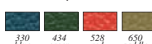
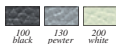

1969 Sport Satellite & GTX Door Panels

Dielectrically heat-sealed Coachman grain panels with woodgrain and chrome accent strips for a factory look and feel. Applications for front and rear of bucket seat equipped 1969 Sport Satellite or GTX 2 door hardtop or convertible. Available in a variety of factory colors to match your upholstery. Made in USA.

Note: Please add 3 digit color code when ordering.

MB1045 1969 front panels 339.99 pr

MB1046 1969 hardtop rear panels 194.99 pr

MB1047 1969 convertible rear panels 124.99 pr

Legendary
AUTO INTERIORS LTD.

Interior Door Panels

— DODGE & PLYMOUTH B-BODY • 1970-74 —



MB1121330

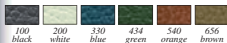

1970 Coronet 440 & Super Bee Door Panels

Dielectrically heat-sealed Coachman grain panels for a factory look and feel. Applications for front and rear of 1970 Coronet 440 or Super Bee 2 door hardtops with bench seat. Available in a variety of factory colors to match your upholstery. Made in USA.

Note: Please add 3 digit color code when ordering.
MB1121 1970 front panels..... 339.99 pr
MB1122 1970 rear panels..... 194.99 pr



MB118656

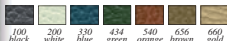

1970 Coronet 500, Coronet R/T & Super Bee

Dielectrically heat-sealed Coachman grain panels for a factory look and feel. Applications for front and rear of 1970 Coronet 500, Coronet R/T or Super Bee 2 door hardtops with bucket seats and convertibles with bench seat. Available in a variety of factory colors to match your upholstery. Made in USA.

Note: Please add 3 digit color code when ordering. *No further discounts apply.

Front Panels
MB1118* 1970 gold - NOS 544.99 pr
MB1118 1970 all other colors..... 324.99 pr

Hardtop Rear Panels
MB1119* 1970 gold - NOS 331.99 pr
MB1119 1970 all other colors..... 186.99 pr

Convertible Rear Panels
MB1120* 1970 gold - NOS 221.99 pr
MB1120 1970 all other colors..... 116.99 pr



MB1075154

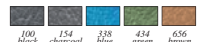

1970 Charger SE Deluxe Door Panels

Dielectrically heat-sealed Kinkle grain panels with map pocket and woodgrain accent for a factory look and feel. Applications for front and rear of 1970 Charger SE. Available in a variety of factory colors. Made in USA.

Note: Please add 3 digit color code when ordering.
MB1075 1970 front panels..... 379.99 pr
MB1076 1970 rear panels..... 194.99 pr

New!



MB1073154

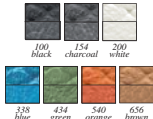

1970 Charger, Charger 500 & Charger R/T Standard Door Panels

Dielectrically heat-sealed Kinkle grain panels with Diamond Basketweave insert and chrome accent for a factory look and feel. Applications for front and rear of 1970 Charger, Charger 500 or Charger R/T equipped with standard upholstery. Available in a variety of factory colors. Made in USA.

Note: Please add 3 digit color code when ordering.
MB1073 1970 front panels..... 339.99 pr
MB1074 1970 rear panels..... 194.99 pr



MB1054103



MB1054663

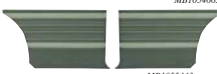

MB1055443

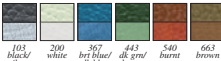

1970 Satellite, Road Runner & Superbird Deluxe Door Panels

Dielectrically heat-sealed Coachman grain panels with Belmont grain accent band for a factory look and feel. Applications for front and rear of Deluxe bench seat equipped 1970 Satellite, Road Runner or Super Bird including 2 door hardtop or convertible models. Available in a variety of factory colors to match your upholstery. Made in USA.

Note: Please add 3 digit color code when ordering.
MB1054 1970 front panels..... 339.99 pr
MB1055 1970 hardtop rear panels..... 194.99 pr
MB1056 1970 convertible rear panels..... 124.99 pr



MB1051115



MB1051363



MB1052439

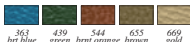
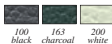

1970 Sport Satellite, Road Runner, GTX & Superbird Door Panels

Dielectrically heat-sealed Coachman grain panels with embossed extruded welt for a factory look and feel. Applications for front and rear of cloth bench or vinyl bucket seat equipped 1970 Sport Satellite, Road Runner, GTX or Superbird including 2 door hardtop or convertible models. Available in a variety of factory original colors to match your upholstery. Made in USA.

Note: No further discounts apply.

Front Panels

MB1051100 1970 black 339.99 pr
MB1051115 1970 black w/silver welt ... 339.99 pr
MB1051163 1970 charc w/silver welt ... 339.99 pr
MB1051200 1970 white 339.99 pr
MB1051363 1970 brt blue w/white welt 339.99 pr
MB1051439 1970 dk grn w/lt grn welt... 339.99 pr
MB1051544 1970 burnt orange 339.99 pr
MB1051655 1970 brown 339.99 pr
MB1051669* 1970 gold w/black welt ... 559.99 pr

Hardtop Rear Panels

MB1052100 1970 black 194.99 pr
MB1052115 1970 black w/silver welt ... 194.99 pr
MB1052163 1970 charc w/silver welt ... 194.99 pr
MB1052200 1970 white 194.99 pr
MB1052363 1970 brt blue w/white welt 194.99 pr
MB1052439 1970 dk grn w/lt grn welt... 194.99 pr
MB1052544 1970 burnt orange 194.99 pr
MB1052655 1970 brown 194.99 pr
MB1052669* 1970 gold w/black welt... 337.99 pr

Convertible Rear Panels

MB1053100 1970 black 124.99 pr
MB1053115 1970 black w/silver welt ... 124.99 pr
MB1053163 1970 charc w/silver welt ... 124.99 pr
MB1053200 1970 white 124.99 pr
MB1053363 1970 brt blue w/white welt 124.99 pr
MB1053439 1970 dk grn w/lt grn welt... 124.99 pr
MB1053544 1970 burnt orange 124.99 pr
MB1053655 1970 brown 124.99 pr

A INTERIOR COMPONENTS

Legendary
AUTO INTERIORS LTD.

Interior Door Panels

— DODGE & PLYMOUTH B-BODY • 1971-73 —



MB1059200



MB1059664

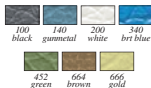

1971 Satellite, Road Runner & GTX Upper Panels

Dielectrically heat-sealed El Paso grain upper panels with woodgrain lower inserts and knurled chrome accent bands with black centers for a factory look and feel. Applications for front and rear of bucket seat equipped 1971 Satellite, Road Runner or GTX 2 door hardtop. Available in a variety of factory colors to match your upholstery. Made in USA.

Note: Please add 3 digit color code when ordering.
MB1059 1971 front panels..... 339.99 pr
MB1060 1971 rear panels..... 194.99 pr



MB1057100



MB1057116

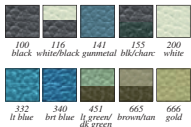

1971 Satellite & Road Runner Upper Panels

Dielectrically heat-sealed Coachman grain upper panels with woodgrain and chrome accent bands for a factory look and feel. Applications for front and rear of bucket seat or Deluxe bench seat equipped 1971 Satellite or Road Runner 2 door hardtop. Available in a variety of factory colors to match your upholstery. Made in USA.

Note: Please add 3 digit color code when ordering.
MB1057 1971 front panels..... 339.99 pr
MB1058 1971 rear panels..... 194.99 pr



MB1067100



MB1067340



MB1068100

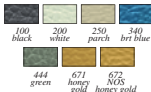

1973 Satellite & Road Runner Upper Door Panels

Dielectrically heat-sealed Coachman grain upper panels with knurled chrome accent for a factory look and feel. Applications for front and rear of bench seat equipped 1973 Satellite & Road Runner 2 door hardtop with Deluxe upholstery. Made in USA.

Note: Please add 3 digit color code when ordering. *No further discounts apply.

Front Panels
MB1067* 1973 honey gold - NOS ... 481.99 pr
MB1067 1973 all other colors..... 339.99 pr
Rear Panels
MB1068* 1973 honey gold - NOS ... 289.99 pr
MB1068 1973 all other colors..... 194.99 pr



MB1063100



MB1063340

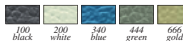

1972 Satellite & Road Runner Upper Panels

Dielectrically heat-sealed Coachman grain upper panels with woodgrain and chrome accent for a factory look and feel. Applications for front and rear of bucket seat equipped 1972 Satellite & Road Runner 2 door hardtop. Made in USA.

Note: Please add 3 digit color code when ordering.
MB1063 1972 front panels..... 339.99 pr
MB1064 1972 rear panels..... 194.99 pr



MB1065100



MB1065444



MB1066100

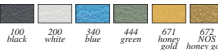

1973 Satellite & Road Runner Cologne Grain Upper Door Panels

Dielectrically heat-sealed Cologne grain upper panels with woodgrain and chrome accent for a factory look and feel. Applications for front and rear of bucket seat equipped 1973 Satellite & Road Runner 2 door hardtop. Made in USA.

Note: Please add 3 digit color code when ordering. *No further discounts apply.

Front Panels
MB1065* 1973 honey gold - NOS ... 459.99 pr
MB1065 1973 all other colors..... 339.99 pr
Rear Panels
MB1066* 1973 honey gold - NOS ... 272.99 pr
MB1066 1973 all other colors 194.99 pr



MB1123340

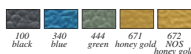

1973 Satellite & Road Runner Coachman Grain Upper Door Panels

Dielectrically heat-sealed Coachman grain upper panels with woodgrain and chrome accent for a factory look and feel. Applications for front and rear of cloth bench seat equipped 1973 Satellite & Road Runner 2 door hardtop. Made in USA.

Note: Please add 3 digit color code when ordering. *No further discounts apply.

Front Panels
MB1123* 1973 honey gold - NOS ... 459.99 pr
MB1123 1973 all other colors..... 339.99 pr
Rear Panels
MB1124* 1973 honey gold - NOS ... 272.99 pr
MB1124 1973 all other colors 194.99 pr



Interior Door Panels

— DODGE & PLYMOUTH B-BODY • 1971-74 —



MB1079340

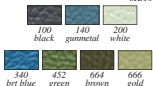

1971 Charger Super Bee Upper Door Panels

Dielectrically heat-sealed Coachman grain upper panels with woodgrain and chrome accent for a factory look and feel. Applications for front and rear of 1971 Charger Super Bee models. Made in USA.

Note: Please add 3 digit color code when ordering.

MB1079 1971 front panels..... 339.99 pr
MB1078 1971 rear panels..... 194.99 pr



MB1077100

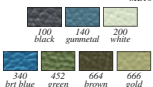

1971 Charger 500, Charger R/T Upper Door Panels

Dielectrically heat-sealed Coachman grain upper panels with woodgrain and chrome accent for a factory look and feel. Applications for front and rear of 1971 Charger 500 or Charger R/T models. Made in USA.

Note: Please add 3 digit color code when ordering.

MB1077 1971 front panels..... 339.99 pr
MB1078 1971 rear panels..... 194.99 pr



MB1080664

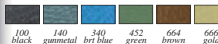

1971 Charger SE Upper Door Panels

Dielectrically heat-sealed Belmont grain upper panels with pillowed center and chromed double-hump woodgrain accent for a factory look and feel. Applications for front and rear of 1971 Charger SE. Available in a variety of factory colors. Made in USA.

Note: Please add 3 digit color code when ordering.

MB1080 1971 front panels..... 369.99 pr
MB1081 1971 rear panels..... 204.99 pr



MB1082100



MB1082340



MB1082444

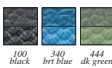

1972 Charger Standard Upper Door Panels

Dielectrically heat-sealed Coachman grain upper and Ranger grain lower with chrome accent for a factory look and feel. Applications for front and rear of 1972 Charger with Standard bench seat upholstery. Available in a variety of factory colors. Made in USA.

Note: Please add 3 digit color code when ordering.

MB1082 1972 front panels..... 339.99 pr
MB1083 1972 rear panels..... 194.99 pr



MB1084100



MB1084662

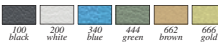

1972 Charger & Charger SE Deluxe Upper Panels

Dielectrically heat-sealed Cologne grain upper and woodgrain lower with chrome accent for a factory look and feel. Applications for front and rear of 1972 Charger with bucket seats or Deluxe bench seat. Available in a variety of factory colors. Made in USA.

Important: Front panels require 8 clips per panel. Rear panels require 3 clips per panel. Door panel clips sold separately.

Note: Please add 3 digit color code when ordering.

MB1084 1972 front panels..... 339.99 pr
MB1085 1972 rear panels..... 194.99 pr



MB1086250

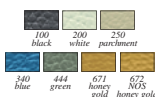

1973 Charger & Charger SE Upper Panels

Dielectrically heat-sealed Coachman grain upper and woodgrain lower with chrome accent for a factory look and feel. Made in USA.

*Note: Please add 3 digit color code when ordering. *No further discounts apply.*



MB1086* 1973 honey gold - NOS..... 459.99 pr
MB1086 1973 all other colors..... 339.99 pr

Rear Panels - Charger

MB1087* 1973 honey gold - NOS..... 272.99 pr
MB1087 1973 all other colors..... 194.99 pr

Rear Panels - Charger SE

MB1088* 1973 honey gold - NOS..... 272.99 pr
MB1088 1973 all other colors..... 194.99 pr



MB1089100



MB1089660

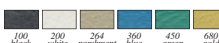

1974 Charger & Charger SE Upper Panels

Dielectrically heat-sealed Oxford grain upper and woodgrain lower with chrome accent for a factory look and feel. Made in USA.

*Note: Please add 3 digit color code when ordering. *No further discounts apply.*



Front Panels - Charger, Charger SE

MB1089* 1974 parchment - NOS..... 474.99 pr
MB1089* 1974 gold - NOS..... 459.99 pr
MB1089 1974 all other colors..... 339.99 pr

Rear Panels - Charger

MB1090* 1974 parchment - NOS..... 281.99 pr
MB1090* 1974 gold - NOS..... 272.99 pr
MB1090 1974 all other colors..... 194.99 pr

Rear Panels - Charger SE

MB1091* 1974 parchment - NOS..... 281.99 pr
MB1091* 1974 gold - NOS..... 272.99 pr
MB1091 1974 all other colors..... 194.99 pr

Interior Door Trim Panels

— DODGE & PLYMOUTH B-BODY • 1968-74 —



MD705100



MD705338



MD706100



MD707100



MD707668

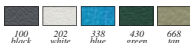

1968-70 Charger Upper Door Pads

In order to completely restore your Charger's interior, you're going to need a pair of front and rear door pads. Molded to factory specifications, these pads feature grains similar to the originals and include the Charger medallion with the correct stainless center.

Note: Please add 3 digit color code when ordering.

Part	Year	Color	Price
MD704	1968	black	374.99 pr
MD704	1968	all other colors	374.99 pr
MD705	1969	black	374.99 pr
MD705	1969	all other colors	374.99 pr
MD706	1970	black	374.99 pr
MD706	1970	all other colors	374.99 pr

Part	Year	Color	Price
MD707	1968-69	black	294.99 pr
MD707	1968-69	all other colors	294.99 pr
MD708	1970	black	294.99 pr
MD708	1970	all other colors	294.99 pr

Get the best for your 1968-70 Charger!



MB1982434



MB1983434

1968-70 Charger Upper Door Pads

Legendary® Upper Door Pads are made to fit and look just like the originals. Manufactured with vacuum formed PVC material on an original style foam and stamped steel core, these upper door pads are sure fit and align perfectly. Features include the year-specific grains, pre-installed door panel clip spacers and door lock knob holes in the factory location. Made in the USA.

Note: Please add 3 digit color code when ordering. No further discounts apply.

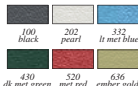

1968 Charger - Cologne Grain

MB1980	1968	front	541.99 pr
MB1981	1968	rear	484.99 pr

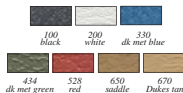

1969 Charger - Ascot Grain

MB1982	1969	front	541.99 pr
MB1983	1969	rear	484.99 pr

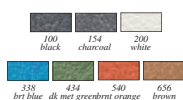

1970 Charger - Krinkle Grain

MB1984	1970	front	541.99 pr
MB1985	1970	rear	484.99 pr



MB1970100



MB1971100



MB1973100

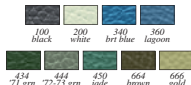

1971-74 B-Body Lower Door & Quarter Panels

Manufactured with vacuum-formed plastic, these panels are molded in your choice of black or white or can be ordered in a variety of factory dyed colors to match your upholstery. Front panels do not include armrest pads, which are sold separately. Rear quarter panels feature molded plastic armrest pad. For 1971-74 Charger, GTX, Road Runner, Satellite or Super Bee. Made in USA.

Important: The black and white panels feature molded-in color and can be installed as-is. However, additional preparation and painting may be required to eliminate tooling marks and any small scratches molded into the plastic. All other colors should require no additional preparation prior to installation. If you do not see your color listed, order the white panels and dye them to the desired color.

Note: Please add 3 digit color code when ordering.

Lower Door Panels

Manual Windows	MB1970	1971-74	black or white	179.99 pr
	MB2970	1971-74	factory colors	229.99 pr

Power Windows	MB3970	1971-74	black or white	179.99 pr
	MB4970	1971-74	factory colors	229.99 pr

Lower Quarter Panels

Manual Windows	MB1971	1971-72	black	199.99 pr
	MB1971	1971-72	white	249.99 pr
	MB2971	1971-72	factory colors	249.99 pr

Power Windows	MB3971	1971-72	white	249.99 pr
	MB4971	1971-72	factory colors	249.99 pr

Manual Windows	MB1973	1973-74	black	199.99 pr
	MB1973	1973-74	white	249.99 pr
	MB2973	1973-74	factory colors	249.99 pr

Power Windows	MB3973	1973-74	black	199.99 pr
	MB3973	1973-74	white	249.99 pr
	MB4973	1973-74	factory colors	249.99 pr

Interior Door Panels

— DODGE & PLYMOUTH E-BODY • 1970-74 —

AUTHENTIC
RESTORATION

OFFER AUTHORIZED



ME859100



ME860200

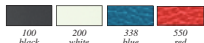

100 black 200 white 338 blue 550 red

1970-74 Barracuda Door & Rear Side Panels

Authentic reproduction door panels for 1970-74 Barracuda/Cuda models. These superior reproductions are injection molded in color, not painted or dyed. Manufactured to appear and fit just like the original with the correct grain, thickness, and bracing.

Note: Please add 3 digit color code when ordering. Shipped double oversize.

Front	ME859	1970-74	black	529.99	pr
Rear	ME860	1970-74	black	529.99	pr

AUTHENTIC
RESTORATION

OFFER AUTHORIZED



ME857100



ME858200



100 black 200 white 338 blue 550 red

1970-74 Challenger Door & Rear Side Panels

Authentic reproduction door panels for 1970-74 Challenger models. These superior reproductions are injection molded in color, not painted or dyed. Manufactured to appear and fit just like the originals with the correct grain, thickness, and bracing.

Note: Please add 3 digit color code when ordering. Shipped double oversize. Ships double oversize.

Front	ME857	1970-74	black	529.99	pr
Rear	ME858	1970-74	black	529.99	pr



ME1990100



ME1991100



ME1993100

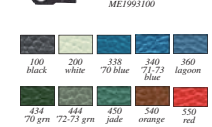

100 black 200 white 338 70 blue 340 71-73 blue 360 lagoon
434 70 grn 444 72-73 grn 450 jade 540 orange 550 red
656 70 brown 664 71 brown 666 gold

1970-74 Challenger Door & Rear Inner Side Panels

Manufactured in vacuum-formed plastic, these door panels are molded in your choice of black or white or can also be ordered in a variety of factory dyed colors to match your upholstery. Armrest pads for front panels are sold separately. For 1970-74 Challenger models with manual or power windows. Made in USA.

Important: The black and white panels feature molded-in color and can be installed as-is. However, additional preparation and painting may be required to eliminate tooling marks and any small scratches molded into the plastic. All other colors should require no additional preparation prior to installation. If you do not see your color listed, order the white panels and dye them to the desired color.

Note: Please add 3 digit color code when ordering.

Door Panels

Manual Windows	ME1990	1970-74	black or white	379.99	pr
	ME2990	1970-74	factory colors	454.99	pr
Power Windows	ME3990	1970-74	black or white	379.99	pr
	ME4990	1970-74	factory colors	454.99	pr

Rear Inner Side Panels

Hardtop with Manual Windows	ME1991	1970-74	black or white	329.99	pr
	ME2991	1970-74	factory colors	399.99	pr
Hardtop with Power Windows	ME3991	1970-74	black or white	329.99	pr
	ME4991	1970-74	factory colors	399.99	pr
Convertible with Manual Windows	ME1993	1970-71	black or white	329.99	pr
	ME2993	1970-71	factory colors	399.99	pr
Convertible with Power Windows	ME3993	1970-71	black or white	329.99	pr
	ME4993	1970-71	factory colors	399.99	pr



ME1980100



ME1981100



ME1983100

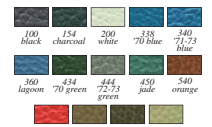

100 black 154 charcoal 200 white 338 blue 340 71-73 blue 360 lagoon 434 70 green 444 72-73 green 450 jade 540 orange 550 red 656 70 brown 664 71 brown 666 gold

1970-74 Barracuda/Cuda Door & Rear Inner Side Panels

Manufactured in vacuum-formed plastic, these door panels are molded in your choice of black or white or can also be ordered in a variety of factory dyed colors to match your upholstery. Armrest pads for front panels are sold separately. For 1970-74 Barracuda or Cuda with manual or power windows. Made in USA.

Important: The black and white panels feature molded-in color and can be installed as-is. However, additional preparation and painting may be required to eliminate tooling marks and any small scratches molded into the plastic. All other colors should require no additional preparation prior to installation. If you do not see your color listed, order the white panels and dye them to the desired color.

Note: Please add 3 digit color code when ordering.

Door Panels

Manual Windows	ME1980	1970-74	black or white	379.99	pr
	ME2980	1970-74	factory colors	454.99	pr
Power Windows	ME3980	1970-74	black or white	379.99	pr
	ME4980	1970-74	factory colors	454.99	pr

Rear Inner Side Panels

Hardtop with Manual Windows	ME1981	1970-74	black or white	329.99	pr
	ME2981	1970-74	factory colors	399.99	pr
Hardtop with Power Windows	ME3981	1970-74	black or white	329.99	pr
	ME4981	1970-74	factory colors	399.99	pr
Convertible with Manual Windows	ME1983	1970-74	black or white	329.99	pr
	ME2983	1970-74	factory colors	399.99	pr
Convertible with Power Windows	ME3983	1970-74	black or white	329.99	pr
	ME4983	1970-74	factory colors	399.99	pr

A INTERIOR COMPONENTS

Kick Panel Components



1967-73 A-Body Kick Panels

Reproduction interior kick panels for 1967-73 Dodge and Plymouth A-Body models. Manufactured from ABS plastic as original to provide a correct appearance and fit.

K3207 1967-73 LH/RH..... 139.99 pr



MB1968100

MB2968338

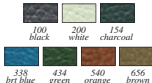

1968-70 B-Body Kick Panels

Replace damaged or missing kick panels and bring your interior back to life. Manufactured with vacuum formed plastic, these kick panels are molded in your choice of black or white. A variety of factory dyed colors are also available to match your upholstery. For colors not offered, we recommend that you order the white panels and dye them to match your interior using OER® vinyl dye sold separately. For 1966-70 B-Body vehicles including Belvedere, Charger, Coronet, GTX, Road Runner, Satellite and Super Bee. Made in USA.

Important: The black and white panels feature molded-in color and can be installed as-is. However for show quality vehicles, additional preparation and painting may be required to eliminate tooling marks and any small scratches molded into the plastic. Colors other than black or white have been prepped and dyed at the factory and should require no additional preparation prior to installation.

Note: Please add 3 digit color code when ordering.
 MB1968 1966-70 black..... 79.99 pr
 MB1968 1966-70 white..... 109.99 pr
 MB2968 1966-70 factory colors..... 109.99 pr



MB1975100

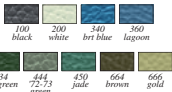

1971-74 B-Body Kick Panels

Manufactured with vacuum formed plastic, these replacement kick panels are molded in your choice of black or white or can also be ordered in a variety of factory dyed colors to match your upholstery. For 1971-74 Charger, Coronet, GTX, Road Runner, Satellite or Super Bee. Made in USA.

Important: The black and white panels feature molded-in color and can be installed as-is. However for show quality vehicles, additional preparation and painting may be required to eliminate tooling marks and any small scratches molded into the plastic. Colors other than black or white have been prepped and dyed at the factory and should require no additional preparation prior to installation.

Note: Please add 3 digit color code when ordering.
 MB1975 1971-74 black or white..... 79.99 pr
 MB2975 1971-74 factory colors..... 109.99 pr



ME1097100

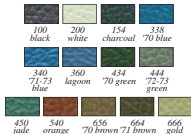

1970-74 E-Body Kick Panels

Manufactured with vacuum formed plastic, these replacement kick panels are molded in your choice of black or white or can also be ordered in a variety of factory dyed colors to match your upholstery. For 1970-74 Barracuda, 'Cuda or Challenger. Please add color code suffix to the part number when ordering. Made in USA.

Important: The black and white panels feature molded-in color and can be installed as-is. However for show quality vehicles, additional preparation and painting may be required to eliminate tooling marks and any small scratches molded into the plastic. Colors other than black or white have been prepped and dyed at the factory and should require no additional preparation prior to installation.

Note: Please add 3 digit color code when ordering.
 ME1097 1970-74 black..... 79.99 pr
 ME1097 1970-74 white..... 109.99 pr
 ME2097 1970-74 factory colors..... 99.99 pr



1963-76 Kick Panel Insulation Sets

Reduce unwanted road noise and vibration with a kick panel insulation kit designed specifically for your Mopar. Each set features the correct type of insulation to dampen noise and vibration like the factory intended. Located on each side of the front footwell area, each set is die-cut to fit perfectly between the plastic kick panel and sheet metal. Applications available for most A-Body, B-Body and E-Body models. Made in USA.

A-Body

MA1321 1963-66 all..... 25.99 set
 MA2320 1967-69 all..... 19.99 set
 MA1320 1970-76 all..... 19.99 set

Dodge B-Body

MB4321 1966-70 Dodge B-Body..... 15.99 set
 MB4322 1971-74 Dodge B-Body..... 24.99 set

Plymouth B-Body

MB5322 1963-64 Belvedere, Fury, Savoy..... 21.99 set
 MB5322 1965 Belvedere, Satellite..... 21.99 set
 MB4321 1966-70 Plymouth B-Body..... 15.99 set
 MB4322 1971-74 Plymouth B-Body..... 24.99 set

Dodge E-Body

ME8321 1970-74 Challenger..... 14.99 set

Plymouth E-Body

ME8321 1970-74 Barracuda, 'Cuda..... 14.99 set

Door Panel Components



1970-72 Duster Door Panel Emblems

Reproduction door panel emblems for 1970-72 Duster models. Molded in black ABS plastic as original. Features the correct silver and white detailing and mounting pins on the back. Two required per car.
3499375 1970-72 29.99 ea



1968-69 B-Body Door Panel Medallions

Replace your front door panel medallions with these quality reproduction pieces. Made from polished 440 stainless steel and painted with correct red, white and blue colors. Includes mounting hardware.
MF1717 1968-69 B-Body 201.99 pr



1968-70 Charger Door Panel Medallion

Door panel medallion for 1968-70 Charger models. This emblem installs on each upper door pad and features correct lettering style and stainless steel center.
MB184614 1968-70 41.99 set



1970-74 Cuda Door Panel Emblem

Reproduction die-cast door panel emblems for 1970-74 Cuda models. Features the correct black detailing and brushed finish face. Includes mounting nuts. Made in USA.
ME1758 1970-74 39.99 pr



1969 Coronet Door Woodgrain Trim

Reproduction upper door woodgrain trim set for 1969 Coronet and Super Bee models. These moldings mount to the door panel, and feature the correct pattern woodgrain and chrome accents.
MB1907 1969 Coronet/Super Bee 324.99 set



1970-74 Door Panel Woodgrain Inserts

Replace the scratched or missing door panel inserts in your 1970 B-body or 1970-74 Challenger. Manufactured in the correct grain on adhesive backed vinyl for easy installation. Must reuse original emblems as they are not included. Sold in pairs.

1970 B-Body
ME1940 1970 w/remote mirror... 49.99 pr
MD2940 1970 w/o remote mirror 49.99 pr
1970-74 Challenger
ME1041 1970-74 14.99 pr



Vinyl Color Chart

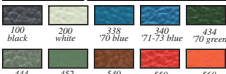

Carpet Color Chart



1970-73 Challenger Door Panel Carpet Trim

Replace the carpeted door panel trim in your 1970-73 Challenger with these accurate reproductions. Each set features new carpeted borders with color matched vinyl edge binding. To order, find your vinyl color below, then select your carpet color from the above carpet chart.

1970 Challenger
ME1270100 1970 black 104.99 pr
ME1270200 1970 white 104.99 pr
ME1270338 1970 bright blue 104.99 pr
ME1270434 1970 dk. metallic grn. 104.99 pr
ME1270540 1970 burnt orange 104.99 pr
ME1270550 1970 red 104.99 pr
ME1270656 1970 brown 104.99 pr
1971 Challenger
ME1271100 1971 black 104.99 pr
ME1271200 1971 white 104.99 pr
ME1271340 1971 bright blue 104.99 pr
ME1271452 1971 dk. metallic grn. 104.99 pr
ME1271560 1971 bright orange 104.99 pr
ME1271664 1971 brown 104.99 pr
ME1271666 1971 ember gold 104.99 pr
ME1271668 1971 tan 104.99 pr

1972-73 Challenger
ME1272100 1972-73 black 104.99 pr
ME1272200 1972-73 white 104.99 pr
ME1272340 1972-73 bright blue 104.99 pr
ME1272444 1972-73 dk. met green 104.99 pr



MD642100

1968-70 A & B-Body Door Panel Vent Plugs

Replacement door panel vent hole plug for 1968-70 A and B-Body applications. This color-keyed plug hides the access hole for the window retaining screw. Sold in pairs, one plug required per door.

MD642100 1968-70 black	12.99 pr
MD642550 1970 red	12.99 pr
MD642202 1968-69 pearl white	12.99 pr
MD642520 1968 metallic red	12.99 pr
MD642526 1968 metallic maroon	12.99 pr
MD642528 1968-69 red	12.99 pr
MD642430 1968 dark met green	12.99 pr
MD642320 1968 metallic navy	12.99 pr
MD642630 1968-69 gold	12.99 pr
MD642330 1968-70 dk metallic blue	12.99 pr
MD642332 1968-70 lt metallic blue	12.99 pr
MD642432 1968-70 lt metallic green	12.99 pr
MD642200 1969 white	12.99 pr
MD642650 1969 saddle	12.99 pr
MD642338 1969-70 bright blue	12.99 pr
MD642434 1969-70 dk metallic green	12.99 pr
MD642154 1969-70 charcoal	12.99 pr
MD642656 1970 brown	12.99 pr
MD642540 1970 burnt orange	12.99 pr



MM2367

Reproduction Door Panel Installation Clips

These restoration-correct clips are reproduced to original specifications to install door panels on your A, B, or E-Body. Made from spring steel as original.
Note: A & B-Body use 36 pieces. E-Body use 14 pieces.

MM2367 36 pieces 29.99 set
MM2367A 14 pieces 14.99 set



PC1011A

Replacement Door Panel Clip Kits

These door panel installation clips are designed to install door panels on your Mopar, A, B, E-Body. Made from spring steel with black oxide coating. Available in kits of 14 or 36.

Note: A & B-Body use 36 pieces. E-Body use 14 pieces.
PC1011A 14 pieces 9.99 kit
PC1011B 36 pieces 25.99 kit

Interior Door Components



MD700

1964-74 A & B Body Door Lock Knobs

Replace cracked or missing door lock knobs to complete your project with authentic detail. These door lock knobs feature the correct fluted design and are available in your choice of black or chrome. Black knobs can be painted to match your interior if desired. For 1964-74 A-Body and B-Body vehicles.

MD700 1964-74 black 5.99 pr
MD701 1964-74 chrome 5.99 pr



1964-74 A & B-Body Billet Lock Knobs

These billet door lock knobs for 1964-74 Mopar A and B-Body muscle cars are machined from solid aluminum and designed to replicate the look of the originals. These billet knobs are polished for a brilliant shine and will not chip or flake like the chromed plastic originals! Made in the USA. MD600342 1964-74 billet 19.99 pr



1970-74 E-Body Door Lock Levers

Replace pitted or missing door lock levers with a set of quality door lock levers from Classic Industries® and take your interior to the next level. These chrome plated levers feature the word "lock" and an arrow insignia to indicate which way to push the lever in order to lock the door. They fit 1970-74 Barracuda, 'Cuda and Challenger. Each pair includes bolts for mounting. One pair required per vehicle.

ME2100 1970-74 27.99 pr



MD103

MD101

MD102

1968-76 Door Lock Ferrules

These ferrules snap into place on your door panel to correctly center the door lock knob where it protrudes through the door panel. The 1964-76A-B-Body ferrules are manufactured with clear injection molded plastic while the others are of stainless steel construction. Available for A-Body and B-Body vehicles. Sold as a pair.

A-Body
MD103 1964-76 clear plastic 14.99 pr
B-Body (except Charger)
MD101 1968-70 stainless steel 17.99 pr
Charger
MD102 1968-70 stainless steel 17.99 pr

New!



CP50038A



CP50039I



CP50040I



CP50042



CP50041C



CP500420



CP50043B

Custom Door Lock Knobs

Want to draw attention to your interior? These custom lock knobs will add a truly personal touch! Choose the design that suits your style. Sold in pairs.

Deluxe Swarovski Diamond Style

CP50038A	blue	11.99 pr
CP50038B	clear	11.99 pr
CP50038C	green	11.99 pr
CP50038D	purple	11.99 pr
CP50038E	red	11.99 pr
CP50038F	amber	11.99 pr

"8" Ball Style

CP50039I	chrome	5.99 pr
CP50040I	chrome	6.99 pr
CP50040I	chrome	5.99 pr

Dice Style

CP50041A	red with white dots	5.99 pr
CP50041B	white with black dots	5.99 pr
CP50041C	black with white dots	5.99 pr
CP50041D	blue with white dots	5.99 pr
CP50041E	green with white dots	5.99 pr
CP50041F	purple with white dots	5.99 pr

Pitton Style

CP500420	chrome	6.99 pr
----------	--------	---------

Skull Head

CP50043B	chrome	6.99 pr
----------	--------	---------

OE AUTHORIZED



1963-66 A & B Body Inner Door Handle

Reproduction of the inner door handle for 1963-66 A and B-body models including Dart, Valiant, Belvedere and Coronet models. Features a chrome finish with the correct in-layed texture on the handle. Includes attaching screw. Sold individually. 2299973 1963-66 19.99 ea

OE AUTHORIZED



MD1701

1968-74 Mopar Inner Door Handles

Reproduction inner door handles for 1968-74 Mopar models. Features triple-chrome plating as original for an authentic appearance. Manufactured and designed to factory specifications, each inner door handle will replace the original exactly. Sold as a pair.

A-Body

MD2145 1968-72	2 door	39.99 pr
MD2145 1968-74	4 door	39.99 pr

B-Body

MD2145 1968-70	2 door	39.99 pr
MD9167 1971-74	2 door	39.99 pr
MD2145 1968-74	4 door wagon	39.99 pr

E-Body

MD8423 1970-74	Barracuda, 'Cuda...	39.99 pr
MD1701 1970-74	Challenger	39.99 pr

OE



MD2589

MB1474

1964-72 Rear Ash Trays

Rear arm rest side panel ashtrays for 1964-72 A, B, and E-Body models. All ash trays manufactured from steel and finished with bright chrome. Sold individually.

1964-72 A-Body

MD2589 1964-66	ash tray	39.99 ea
MA6997 1968-72	ash tray	41.99 ea
MA6998 1968-72	bezel	6.99 ea
MA6999 1968-72	ash tray & bezel	49.99 set

1964-70 B-Body

MD2589 1964-65	ash tray	39.99 ea
MB1474 1966-70	ash tray	25.99 ea
MB1475 1966-70	bezel	6.99 ea
MB1476 1966-70	ash tray & bezel	29.99 set

1970 E-Body

MB1474 1970	ash tray	25.99 ea
MB1475 1970	bezel	6.99 ea
MB1476 1970	ash tray & bezel	29.99 set

Interior Door Components

— DODGE & PLYMOUTH · 1962-74 —



1962-66 A & B-Body Window Crank Handles

Replacement window crank handles for 1962-66 A-Body and B-Body models. Features correct chrome finish and knob diameter for an authentic appearance. Fits front or rear. Will not fit Charger models. Sold as a pair.

MB1244 1962-66..... 34.99 pr



1967 A & B-Body Window Crank Handles

Replacement window crank handles for 1967 A-Body and B-Body models. Features correct chrome finish and correct knob diameter for an authentic appearance. Fits front or rear. Sold as a pair.

MD157 1967..... 38.99 pr



K27265



MD1627

1968-76 Window Crank Handles

These replacement window crank handles for 1968-76 A, B, and E-Body models are manufactured to original specifications with correct finish for authenticity. Fits front or rear. Sold individually or as a pair.

2862167 1968-74 12.99 ea
K27265 1968-74 23.99 pr
MD1627 1975-76 screw included... 10.99 ea
K27266 1975-76 19.99 pr



1966-67 Charger Window Handle Spacer

Reproduction of the spacer that installs behind the window handles on 1966-67 Dodge Charger models. Manufactured with a chrome finish as original. Sold individually.

MB1473 1966-67..... 7.99 ea



MD35232

MD35231

1968-74 Window Crank Shims

These authentic window crank handle spacers are designed with the correct thickness to replace cracked or missing original spacers precisely. Available for front or rear.

A-Body

Front Hardtop or Convertible
MB1473 1966-67 Charger, chrome..... 1.99 pr
Rear Hardtop
MD35232 1968-74 3.99 ea
Rear Convertible
MD35231 1968-69 1.99 pr

B-Body

Front 2 Door Hardtop or Convertible
MB1473 1966-67 Charger, chrome..... 7.99 ea
MD35231 1968-74 1.99 pr
Rear 2 Door Hardtop or Convertible
MD35231 1968-70 1.99 pr
MD35232 1971-74 3.99 ea
Rear 4 Door or Wagon
MD35231 1968-70 1.99 pr
MD35232 1971 3.99 ea
MD35231 1972-74 1.99 pr

E-Body

Front
MD35231 1970-74 'Cuda 1.99 pr
MD35232 1970-74 Challenger 3.99 ea
Rear
MD99870 1970-74 'Cuda 3.99 ea



1968-74 Window Crank Handle Screw

These window crank handle screws will replace stripped or missing original screws perfectly. Each window crank handle screw features correct chrome finish, thread and head design for an authentic appearance. Fits 1968-74 A-Body including Barracuda, Dart, Demon/Dart Sport, Scamp, Valiant, 1968-74 B-Body including Belvedere, Charger, Coronet, GTX, Road Runner, Satellite, Super Bee, 1970-74 E-Body including Barracuda, 'Cuda and Challenger. Fits front or rear. Use as required.

MD27221 1968-7499 ea



MB2002



2788046

1964-72 A-Body Arm Rest Bases

Reproduction front and rear arm rest bases for 1964-72 A-Body models. Manufactured unpainted or with a chrome bake for a high gloss mirror finish.

Front Arm Rest Bases

Barracuda, Dart, Valiant
MA2028 1964-66 chrome, 11" 79.99 pr
MB2002 1964-66 chrome, 15" 69.99 pr
MA1532 1967 chrome 114.99 pr
MA1533 1968-69 chrome 59.99 pr

1970-72 A-Body

MA1533 1970-72 chrome 59.99 pr
MA1098 1970-72 black 49.99 pr

Rear Arm Rest Bases

Barracuda, Dart, Valiant
MA1531 1964-66 chrome, 10" 59.99 pr
MD165510 1964-66 chrome, 11" 119.99 pr
2788046 1967 chrome 49.99 ea
MA1534 1967-72 chrome 29.99 ea

1970-72 A-Body

MA1535 1970-72 paintable 27.99 ea



MB2003

1964-70 B-Body Arm Rest Bases

Reproduction front and rear arm rest bases for 1964-70 B-Body models. Injection molded and chrome plated for a mirror-like finish.

Front Arm Rest Bases

Savoy, Belvedere, Fury, 330, 440, Polara
MB2028 1964 chrome, 11" 24.99 ea
MB2002 1964 chrome, 15" 69.99 pr

Plymouth B-Body

MB2028 1964 chrome, 11" 24.99 ea
MB2002 1965 chrome, 15" 69.99 pr
MB2003 1966-70 chrome, 16.25" 54.99 pr
MB2004 1966-70 chrome, 13" 54.99 pr

Coronet, Charger

MB2002 1965 chrome 69.99 pr
MB2003 1966-70 chrome, 16.25" 54.99 pr
MB2004 1966-70 chrome, 13" 54.99 pr

Rear Arm Rest Bases

B-Body (Except Charger)
MD165510 1964-65 chrome, 11" 119.99 pr
MB2005 1966-70 chrome, 8.00" 51.99 pr

A INTERIOR COMPONENTS

Interior Door Components

— DODGE & PLYMOUTH • 1964-74 —

New!



MF1753



MF1754

1964-66 A/B-Body Arm Rest Pads

Replace the cracked, deteriorated or missing arm rest pads on your 1964-66 A-Body and 1964-65 B-Body with a pair of these arm rest pads and bring new life to your interior. Manufactured in urethane and features the correct grain.

Front Pads - 10-1/2"

MF1753 1964-66	A-Body - black.....	54.99 pr
MF1753 1964-65	B-Body - black.....	54.99 pr
MP15002 1964-66	A-Body - red.....	54.99 pr
MP15002 1964-65	B-Body - red.....	54.99 pr

Rear Pads - 10-1/2"

MF1754 1964-66	A-Body - black.....	54.99 pr
MF1754 1964-65	B-Body - black.....	54.99 pr
MP16002 1964-66	A-Body - red.....	54.99 pr
MP16002 1964-65	B-Body - red.....	54.99 pr

AUTHORIZED



MD240

1968-69 A-Body Arm Rest Pads

7-1/2" replacement arm rest pads for 1968-69 model A-Body. These arm rest pads will fit the front or rear of most 1968-69 models including Barracuda, Dart and Valiant. Produced in urethane with the correct grain. Sold individually.

Note: Some early production 1968 models used the 1967 shorter arm rest pad.

Front or Rear, 7-1/2"

MD240 1968-69	black.....	44.99 ea
MD241 1968-69	white.....	44.99 ea

New!



1967 A-Body Arm Rest

Replace the original, deteriorated or missing arm rest pads on your 1967 A-Body with a pair of these arm rest pads and bring new life to your interior. Manufactured in urethane and features the correct grain.

MF1757 1967	64.99 pr
-------------	-------	----------

AUTHORIZED



MD240

1970-72 A-Body Front Arm Rest Pads

Replacement front arm rest pads for 1970-72 model A-Body. Produced in urethane with the correct grain. Sold individually.

Front Only - 7-1/2"

MD240 1970-72	black.....	44.99 ea
MD241 1970-72	white.....	44.99 ea



MD281

1966-70 B-Body 9" Arm Rest Pads

Replace the cracked, deteriorated or missing arm rest pads on your 1966-70 B-Body with a pair of these 9" arm rest pads and bring new life to your interior. These arm rest pads are found on various 1966-70 Belvedere, Coronet, GTX, Road Runner and Satellite models. Manufactured in urethane and feature the correct grain. May fit front or rear depending on the model, however, they do not have the provision for the rear astray like the originals.

MD280 1966-70	black.....	39.99 ea
MD281 1966-70	white.....	39.99 ea

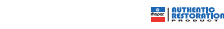

MD270

1966-70 B-Body Front 13" Arm Rest Pads

Replacement pads for certain 1966-67 Belvedere, Coronet, GTX and Satellite and 1966-70 Chargers. Manufactured urethane with the correct grain. Available in black or white. Sold as a pair.

Note: These longer 13" armrests are found on some 1966-67 B-Body cars and 1966-70 Chargers. Some models were equipped with a different style or shorter armrest.

MD270 1966-70	black.....	64.99 pr
MD271 1966-70	white.....	64.99 pr



MD2465

1971-74 B-Body Front Arm Rest Pads

Replace the cracked, deteriorated or missing arm rest pads on your 1971-74 B-Body vehicle with a set of urethane arm rest pads and dramatically improve the appearance of your interior. These replacement arm rest pads for 1971-74 B-Body models are manufactured in urethane in the correct original grain. Each pair is available in your choice of black or white.

MD2465 1971-74	black.....	84.99 pr
MD2466 1971-74	white.....	84.99 pr

AUTHORIZED



MD290

1971-72 B-Body Rear Arm Rest Pads

Replace the cracked, deteriorated or missing rear arm rest pads on your 1971-72 B-Body with a pair of these authentic looking replacement pads and bring new life to your interior. These arm rest pads fit 1971-72 Charger, Road Runner, Satellite and 1971 GTX, manufactured urethane and feature the correct grain. Available in both black and white.

MD290 1971-72	black.....	84.99 pr
MD291 1971-72	white.....	79.99 pr

AUTHORIZED



MD300

1970-74 Barracuda Front Arm Rest Pads

Replace the cracked, deteriorated or missing arm rest pads on your 1970-74 Barracuda with a pair of these original looking arm rest pads and bring new life to your interior. Produced in urethane with the correct grain. Available in both black and white.

MD300 1970-74	black.....	84.99 pr
MD301 1970-74	white.....	109.99 pr

AUTHORIZED



MD310

1970-74 Challenger Arm Rest Pads

Replace the cracked, deteriorated or missing arm rest pads on your 1970-74 Challenger with a pair of these authentic looking pads and bring new life to your interior. Available in black and white. Produced in urethane with the correct grain.

MD310 1970-74	black.....	84.99 pr
MD311 1970-74	white.....	109.99 pr



MA1536

1964-76 Arm Rest Base Screws

Replacement arm rest base screws for all 1964-76 A-Body and B-Body models. Replace your missing screws with correct style screws for a proper fit.

MA1536 1964-66	set of 4.....	6.99 set
MA1537 1967-76	set of 4.....	6.99 set

Dodge & Plymouth Headliners

Replace the torn, discolored or saggy headliner in your classic Mopar with a new headliner from Classic Industries*. Manufactured by hand using the finest craftsmanship and materials, these quality replacement headliners feature napped

cotton cloth, Premier perforated or Premier non-perforated vinyl material and are offered in a variety of colors to match or accent your interior. Made in USA.

Note: Please add two digit color code when ordering.

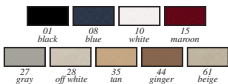

Leather Grain Vinyl Headliners

1960-61 Lancer & Valiant

1960 Valiant	MA2013 1960	2 door, 4 door	189.99 ea
	MA2014 1960	station wagon	219.99 ea
1961 Lancer, Valiant	MA2015 1961	2 door, 4 door	189.99 ea
	MA2014 1961	station wagon	219.99 ea
1962 Lancer, Valiant	MA2016 1962	except wagon	189.99 ea
	MA2018 1962	station wagon	219.99 ea

1962 Dart, Polara 500

Applications to fit 2 and 4 door sedan and hardtop models including 1962 Dodge Dart, Dart 330, Dart 440 and Polara 500. Please specify color when ordering.
*Note: *1962 Hardtop models were originally equipped with board style headliners. A conversion style, bow suspended headliner is offered for these models. Conversion of headliner to bow style requires measuring and drilling holes for bow installation. Instructions and bows are included.*

1962 Dart, Dart 330, Dart 440	MB3004 1962	2 & 4 door sedan	184.99 ea
1962 Dart 330, Dart 440, Polara 500	MB3005* 1962	2 & 4 door hardtop	241.99 ea

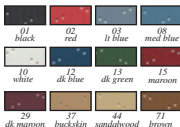

Premier Perforated Vinyl Headliners

*Note: *Some models were originally equipped with board style headliners. A bow suspended, conversion style headliner is offered for these models. Conversion of headliner to bow style requires measuring and drilling holes for bow installation. Instructions and bows are included.*

1963-75 Dodge A-Body

1963-66 Dart, Dart 170, Dart 270, Dart GT	MA2022 1963-66	2 door, 4 door	164.99 ea
	MA2023 1963-66	station wagon	198.99 ea
1967-68 Dart, Dart 270	MA2024 1967-69	2 dr sedan with post.	164.99 ea
1967-71 Dart, Dart Custom	MA2024 1967-71	4 door sedan (w/5 bow)	164.99 ea
Early 1972 Dart, Dart Custom	MA2024 1972	4 dr sedan (w/5 bow)	164.99 ea
Late 1972-75 Dart, Dart Custom	MA2040 1972-75	4 dr sedan (w/4 bow)	159.99 ea
1967 Dart 270, GT	MA2025 1967	2 door hardtop	79.99 ea
1968 Dart 270, GT, GTS	MA2025 1968	2 door hardtop	79.99 ea
1969 Dart 270, Dart Custom, GT, GTS	MA2025 1969	2 door hardtop	79.99 ea
1970 Dart Custom	MA2025 1970	2 door hardtop	79.99 ea
1971-72 Dart Swinger	MA2025 1971-72	2 door hardtop	79.99 ea
1973-75 Dart Swinger	MA2058 1973-75	2 dr ht (conversion)	148.99 ea

1963-71 Dodge B-Body

1963-64 Dodge 330, 440, Polara, Polara 500	MB3040 1963	except wagon	164.99 ea
	MB3039* 1963	2 1/4 dr ht (conversion)	239.99 ea
	MB3018 1964	except wagon	184.99 ea
	MB3013* 1964	2 dr ht (conversion)	239.99 ea
	MB3014 1964	2 dr ht w/bow style	94.99 ea
1965-67 Coronet	MB3015 1965	2 door ht	94.99 ea
	MB3022 1966-67	sedan w/4 bow	184.99 ea
	MB3023 1966-67	sedan w/5 bow	184.99 ea
	MB3024 1966-67	2 door ht	98.99 ea
1968-70 Coronet, Super Bee	MB3028 1968	2 door ht	98.99 ea
	MB3028 1969-70	2 door ht	78.99 ea
1968-71 Coronet	MB3030 1968-70	4 door sedan	184.99 ea
	MB3031 1971	4 dr sedan w/6 bow	184.99 ea
	MB3032 1971	4 dr sedan w/4 bow	184.99 ea
1966-70 Charger	MB3025* 1966-67	2 door fastback	149.99 ea
	MB3027 1968-70	2 door ht	98.99 ea
1969-70 Charger 500, Daytona	MB3029 1969-70	2 door ht	78.99 ea
1971 Charger, Super Bee	MB3033 1971	2 dr ht (w/6 bow)	78.99 ea
	MB3034 1971	2 dr ht (w/4 bow)	78.99 ea

1963-75 Plymouth A-Body

1964-69 Barracuda	MA2019 1964-66	2 door fastback	81.99 ea
	MA2020 1967-69	2 door fastback	81.99 ea
	MA2021 1967-69	2 door notchback	98.99 ea
1966-66 Valiant	MA2027 1963-66	2 door, 4 dr	164.99 ea
	MA2023 1963-66	station wagon	198.99 ea
1967-71 Valiant 100, 200, Signet	MA2024 1967-69	2 door with post.	164.99 ea
	MA2024 1967-71	4 door sedan	164.99 ea
Early 1972 Valiant	MA2024 1972	4 door w/ 5 bow	164.99 ea
Late 1972-75 Valiant	MA2040 1972-73	4 door w/ 4 bow	159.99 ea
1971-75 Valiant Scamp	MA2025 1971-72	2 door hardtop	79.99 ea
	MA2058 1973-75	2 dr ht (conversion)	148.99 ea
1970 Duster	MA2033 1970	2 door coupe	78.99 ea
1971 Demon, Duster	MA2035 1971	early 1971-6 bow	78.99 ea
	MA2035 1971	late 1971-4 bow	78.99 ea
1972 Demon, 1973-75 Dart Sport, 1972-75 Duster	MA2034 1972-75	conversion style	159.99 ea

1963-75 Plymouth B-Body

1963 Belvedere, Fury, Savoy, Sport Fury	MB3012 1963	except wagon	191.99 ea
	MB3011* 1963	2 dr ht (conversion)	241.99 ea
1964-65 Belvedere	MB3020 1964-65	2 1/4 door sedan	184.99 ea
1964 Fury, Savoy	MB3020 1964	2 1/4 door sedan	184.99 ea
1964 Fury	MB3021 1964	4 door hardtop	184.99 ea
1964 Belvedere, Fury, Sport Fury	MB3013* 1964	2 dr ht (conversion)	239.99 ea
	MB3014 1964	4 dr ht w/bow style	94.99 ea
1965 Belvedere II, Satellite	MB3015 1965	2 door hardtop	94.99 ea
1966-67 Belvedere	MB3022 1966-67	2 1/4 door w/4 bow	184.99 ea
	MB3023 1966-67	2 1/4 door w/5 bow	184.99 ea
1966-67 Belvedere, GTX, Satellite	MB3024 1966-67	4 door hardtop	98.99 ea
1968-70 Belvedere, GTX, Road Runner, Satellite	MB3026 1968	2 door hardtop	98.99 ea
	MB3028 1969-70	2 door hardtop	78.99 ea
1969-70 Superbird	MB3025 1969-70	2 door hardtop	78.99 ea
1971 GTX, Road Runner, Satellite	MB3033 1971	2 door hdp w/6 bow	78.99 ea
	MB3034 1971	2 door hdp w/4 bow	78.99 ea



Cloth Headliner

Applications to fit 1960-62 Lancer and Valiant.

1960 Valiant	MA2001 1960	2 door, 4 door	239.99 ea
	MA2002 1960	station wagon	254.99 ea
1961 Lancer, Valiant	MA2003 1961	2 door, 4 door	239.99 ea
	MA2002 1961	station wagon	254.99 ea
1962 Lancer, Valiant	MA2004 1962	except wagon	239.99 ea
	MA2006 1962	station wagon	254.99 ea

1962 Belvedere, Fury and Savoy

Applications to fit 2 and 4 door sedan and hardtop models including 1962 Belvedere, Fury, Savoy, Dodge Dart, Dart 330, Dart 440 and Polara 500. Please specify color when ordering.

*Note: *Some 1962 hardtop models were originally equipped with board style headliners. A conversion style, bow suspended headliner is offered for these models. Conversion of headliner to bow style requires measuring and drilling holes for bow installation. Instructions and bows are included.*

1962 Belvedere, Fury, Savoy	MB3001 1962	except wagon	239.99 ea
1960-61 Dart, Dart 330, Dart 440 sedan	MB3002 1962	2 & 4 door sedan	239.99 ea
1962 Dart 330, Dart 440, Polara 500 hardtop	MB3003* 1962	2 & 4 door hdp	254.99 ea

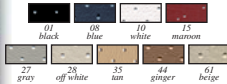

Perforated Vinyl Headliners

1960-61 Lancer & Valiant

1960 Valiant	MA2007 1960	2 door, 4 door	189.99 ea
	MA2008 1960	station wagon	219.99 ea
1961 Lancer, Valiant	MA2009 1961	2 door, 4 door	189.99 ea
	MA2008 1961	station wagon	219.99 ea
1962 Lancer, Valiant	MA2010 1962	except wagon	189.99 ea
	MA2012 1962	station wagon	219.99 ea

Dodge & Plymouth Headliners

1963-71 Plymouth B-Body Cont'd

1968-70 Belvedere, Satellite	
MB3030	1968-70 4 dr sedan 184.99 ea
1971 Satellite	
MB3031	1971 4 dr w/6 bow 184.99 ea
MB3032	1971 4 dr w/4 bow 184.99 ea

1970-71 Dodge & Plymouth E-Body

1970-71 Barracuda, 'Cuda	
ME4001	1970 2 dr hdtip 78.99 ea
ME4002	1971 2 dr hdtip w/5 bow 78.99 ea
ME4003	1971 2 dr hdtip w/4 bow 78.99 ea
1970-71 Challenger	
ME4004	1970 2 dr hdtip 78.99 ea
ME4005	1971 2 dr hdtip w/5 bow 78.99 ea
ME4006	1971 2 dr hdtip w/4 bow 78.99 ea



Premier Non-Perforated Vinyl Headliners

Headliners for 1974-76 A-Body

1974-76 Dart, Dart Custom, Valiant	
MA2042	1974-76 4 door sedan 159.99 ea

1972-74 Dodge & Plymouth B-Body

1972-74 Charger, Road Runner, Satellite	
MB3035	1972-74 2 door hardtop 78.99 ea
1972-74 Coronet, Satellite	
MB3036	1972-74 4 door sedan 184.99 ea

1972-74 Dodge & Plymouth E-Body

1972-74 Barracuda, 'Cuda	
ME4007	1972-74 2 door hardtop 78.99 ea
1972-74 Challenger	
ME4008	1972-74 2 door hardtop 78.99 ea

Tier Grain Vinyl

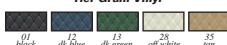

Foam Backed Cloth

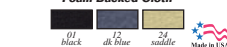

1972-76 A-Body ABS Plastic Headliner Board

Replace the droopy or deteriorated board-style headliner in your classic car with an ABS plastic headliner from Classic Industries®. These replacement headliners will fit all models originally equipped with the board style headliner. Your choice of foam backed Tier grain vinyl or foam backed Cloth in a variety of colors to match or accent your interior. Or select the uncovered board for a do-it-yourself template and recover it in your own fabric. Made in USA.

*Note: *Please add two digit color code when ordering.*

1972-76 Demon, Duster, Dart Sport	
MA2051	1972-76 uncovered board 204.99 ea
MA2049*	1972-76 tier grain vinyl 248.99 ea
MA2050*	1972-76 cloth 248.99 ea
1972-76 Demon, Duster, Dart Sport w/ Sunroof	
MA2054	1972-76 uncovered board 204.99 ea
MA2052*	1972-76 tier grain vinyl 248.99 ea
MA2053*	1972-76 cloth 248.99 ea
1973-76 Dart Swinger, Valiant, Scamp	
MA2057	1973-76 uncovered board 204.99 ea
MA2055*	1972-76 tier grain vinyl 248.99 ea
MA2056*	1972-76 cloth 248.99 ea

New!

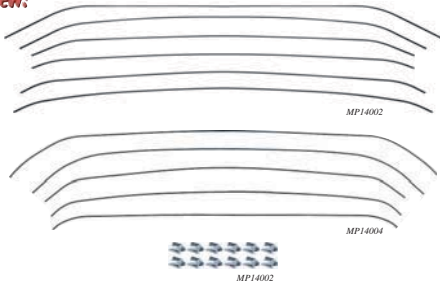

1967-74 Headliner Bows

Reproduction headliner bows for 1967-74 A, B, and E-body models. Headliner bows are numbered from front to back for a simplified installation. Original style bow clips are sold separately.

*Note: *For late 1971 B-bodies, discard the #3 and #5 bows. **For 1972-74 E-Bodies, discard the #3 bow.*

A-Body	MP19001	1967-72	5 bows, 10 clips required	74.99 set
B-Body	MP19002	1968-70	6 bows, 12 clips required	84.99 set
	MP19003*	1971-74	6 bows, clips not required	84.99 set
Challenger	MP19004	1970-71	5 bows, 10 clips required	74.99 set
	MP19005**	late 1971-74	5 bows, clips not required	74.99 set
Barracuda	MP19006	1970-71	5 bows, 10 clips required	74.99 set
	MP19007	1971-74	4 bows, clips not required	74.99 set
Installation Clips	MP19008	1967-74	set of 10 clips	21.99 set
	MP19009	1967-74	set of 12 clips	24.99 set

1962-76 Headliner Insulation

Headliner insulation is glued directly to the roof prior to headliner installation to reduce heat and improve sound deadening of the passenger compartment.



MB454



Headliner and Upholstery Tool

Great for tucking headliner or upholstery material into tedious channels without damaging the material. When replacing your upholstery or headliner be sure you have all the necessary tools. This tool helps you to evenly tuck the excess materials into the correct channels giving your finished job a clean, professional look. Easy to use around curves and near corners.

A7672 9.99 ea

Headliner Installation Glue

Replace your headliner easily with the correct glue application used to adhere the headliner to the roof panel. This is specially designed for use with early style headliners. This can contains 4 fluid ounces with a handy brush for easy application of glue. You will need this special glue if you are installing the headliner yourself. Be sure to have all the equipment you need to get professional results.



K17000 8.99 ea

Dome Lamp Components

USA AUTHORIZED

USA AUTHENTIC RESTORATION



1960-64 B-Body Dome Lamp Assembly

Replacement dome lamp lens and bezel for 1960-64 B-Body Mopar 2 door and 4 door sedan models. Repair the cracked, faded or broken dome lamp in your vehicle with a brand new lens set. Includes lens, bezel and 2 mounting screws.

Note: Lens is opaque with a slight tint like the originals.
MJ476 1960-64 B-Body sedans 44.99 set

USA AUTHORIZED

USA AUTHENTIC RESTORATION



MA9902



MA9903

1964-66 Barracuda Dome Lens and Bezel

Factory style reproduction dome lens and bezel for 1964-66 Plymouth Barracuda models. Each piece is manufactured to original specifications. Mounts to the interior rear pillar on both sides.

MA9902 1964-66 lens, pair 16.99 pr
MA9903 1964-66 bezel - 2 required ... 14.99 ea

USA AUTHENTIC RESTORATION



1967-69 Barracuda Dome Lamp Assembly

Replacement dome lamp assembly for 1967-69 Barracuda models. Repair the broken, pitted, yellowed or missing dome lamps in your vehicle with a fresh new set. Includes the bezel and lens only. Sold in pairs.

MJ477 1967-69 78.99 pr

USA AUTHORIZED

USA AUTHENTIC RESTORATION



MJ92995



MJ92996

1964-74 Dome Lamp Lenses

Replacement dome lamp lenses for 1964-74 A-Body, B-Body, and E-Body models. Located in the center of the headliner on most models.

Note: Lens is opaque with a slight tint like the originals.

A-Body
MJ92995 1964 Dart & Valiant 6.99 ea
MJ92995 1965-74 Dart & Valiant 6.99 ea
MJ92995 1967-69 Barracuda 6.99 ea

B-Body
MJ92995 1966-70 Belvedere 6.99 ea
MJ92995 1966-74 Coronet 6.99 ea
MJ92995 1966-74 Satellite 6.99 ea
MJ92996 1966-67 Charger 17.99 pr
MJ92995 1968-74 Charger hardtop 6.99 ea

E-Body
MJ92995 1971-74 Barracuda 6.99 ea
MJ92995 1971-74 Challenger 6.99 ea



SW101

SW90

1960-76 Door Jamb Switches

Replacement door jamb switches for various Mopar models. These service replacement switches may differ in appearance from originals but are correct in fit and function.

1 Terminal
SW 101 1960-74 Valiant 5.99 ea
SW 101 1962-73 Dart 5.99 ea
SW 101 1962-64 Savoy 5.99 ea
SW 101 1962-64 Polara 5.99 ea
SW 101 1962-70 Belvedere 5.99 ea
SW 101 1962-64 Fury 5.99 ea
SW 101 1961-62 Lancer 5.99 ea
SW 101 1963-64 330 5.99 ea
SW 101 1963-64 440 5.99 ea
SW 101 1964-73 Barracuda 5.99 ea
SW 101 1965-73 Coronet 5.99 ea
SW 101 1965-74 Satellite 5.99 ea
SW 101 1966-73 Charger 5.99 ea
SW 101 1967-71 GTX 5.99 ea
SW 101 1968-71 Road Runner 5.99 ea
SW 101 1970-73 Challenger 5.99 ea
SW 101 1970-74 Duster 5.99 ea
SW 101 1971 Scamp 5.99 ea

2 Terminal
SW90 1972-74 Satellite 6.99 ea
SW90 1972-76 Valiant 6.99 ea
SW90 1973-74 Challenger 6.99 ea
SW90 1973-74 Barracuda, Cuda 6.99 ea
SW90 1973-76 Duster 6.99 ea
SW90 1974 Charger 6.99 ea
SW90 1974 Coronet 6.99 ea
SW90 1974-76 Dart 6.99 ea
SW90 1975-76 Scamp 6.99 ea

USA AUTHENTIC RESTORATION



1960-68 Dome Lamp Dimmer

Softens the interior lighting of your muscle car with this dome lamp dimmer, which keeps the interior lamp on an extra three seconds then slowly fades off, instead of simply switching off. This dimmer is easily installed and can be mounted in any location where electrical connections are easily accessible.

RE13001 1960-68 49.99 ea

USA AUTHORIZED

USA AUTHENTIC RESTORATION



1964-66 Courtesy Lamp Lenses

Replacement courtesy lamp lenses for 1964-66 A-Body and B-Body vehicles. Located on sedan door posts or in rear of passenger compartment on both sail panels on vehicles with courtesy lamp feature. Sold in pairs only.

Note: Lenses are opaque with a slight tint like the originals.

A-Body
MA9902 1964 Valiant 16.99 pr
MA9902 1964-66 Barracuda 16.99 pr
B-Body 2 Door Hardtop
MA9902 1964-66 Dodge B-Body 16.99 pr
MA9902 1964-66 Plymouth B-Body 16.99 pr



Replacement Dome Lamp Bulbs

Replacement dome lamp bulbs for various applications. Please see the lamp bulb chart in the information section for a comprehensive list for specific applications.

57 replaces bulb #57 1.99 ea
1004 replaces bulb #1004 2.99 ea
B2112 replaces bulb #211-2 1.99 ea
562 replaces bulb #562 2.99 ea

Reference Our Comprehensive Light Bulb Guide

Refer to the information section (Section 04) for a complete and detailed list of light bulbs for applications covered in this catalog.

- A-Body Models
- B-Body Models
- E-Body Models

Located in the Back of the Catalog

A INTERIOR COMPONENTS

Interior Trim



MB1503



MB1504



MB1505



MB1506

4-DOOR AUTHORIZED

1964-70 B-Body Inner Rear Window Trim

Reproduction inner rear window trim for 1964-70 Dodge & Plymouth B-Body models. Manufactured with molded plastic as original. Available in black only, but can be painted to match your interior with OER® interior paint (sold separately).

1964-65 B-Body

Fits 1964-65 2 and 4-door B-Body models.
MB1503 1964-65 3 piece set..... 67.99 set

1968-70 Charger

6 piece set includes 3 piece upper set, 2 piece lower corner set and lower trim section. 4 piece set includes upper set and lower trim

MB1504 1968-70 6 piece set..... 99.99 set
MB2806 1968-70 4 piece set..... 74.99 set
MB2807 1968-70 lower corners..... 34.99 pr
MB2808 1968-70 lower trim section..... 19.99 ea

1968-69 Charger 500 & Daytona

6 piece set includes 3 piece upper set, 2 piece lower corner set and lower trim section.

MB1505 1969 6 piece set..... 99.99 set
MB2805 1969 upper set - 3 pc set..... 59.99 set
MB2807 1968-69 lower corners..... 34.99 pr
MB2808 1968-69 lower trim section..... 19.99 ea

1968-70 Coronet

6 piece set includes 3 piece upper set, 2 piece lower corner set and lower trim section.

MB1506 1968-70 6 pc. base models... 104.99 set

1968-70 Coronet R/T & 440

3 piece upper set includes LH and RH trim sections and center piece. 5 piece set includes upper set & lower corners

MB2802 1968-70 5 piece set..... 74.99 set
MB1507 1968-70 upper set - 3 pc set..... 79.99 set
MB1508 1968-70 lower corners..... 24.99 pr
MB1509 1968-70 lower trim section..... 38.99 ea

1968-70 Plymouth B-Body

3 piece upper set includes LH and RH trim sections and center piece. 4 piece set includes 3 piece upper set and lower trim section.

MB1510 1968-70 4 piece set..... 96.99 set
MB2803 1968-70 upper set - 3 pc set..... 59.99 set
MB2804 1968-70 lower trim only..... 39.99 ea

New!



MP14001

MP14002

1965-66 A-Body Pillar Post Moldings

Reproduction pillar post moldings for 1965-66 A-Body models. Manufactured in black molded plastic as a direct replacement for the originals. Fits 1965-66 Barracuda, 1965-66 Valiant 2-door hardtop, and 1965-66 Dart 2-door hardtop models.

MP14001 1965-66 driver side..... 99.99 ea
MP14002 1965-66 passenger side..... 99.99 ea

New!



1967-72 A-Body Pillar Post Molding

Reproduction inner pillar post moldings for 1967-72 Dodge Dart hardtop and 1967-69 Barracuda models. Manufactured from injection molded ABS plastic and feature the correct grain for exact replacements.
MA8181100 1967-72..... 164.99 pr



MB1521100



MB1521434

6 piece set

black white parchment brt blue laagoon blue

dk green dk green jade green brown ember gold

dk green dk green jade green brown ember gold

1971-74 B-Body Pillar Post Moldings

Reproduction pillar post molding for 1971-74 B-Body models. Manufactured in injection molded ABS plastic with correct grain for an exact replacement. Fits all 1971-74 two-door B-Body models.

MB1521100 1971-74 black..... 159.99 pr
MB1521200 1971-74 white..... 164.99 pr
MB1521250 1971-74 parchment..... 164.99 pr
MB1521340 1971-74 bright blue..... 164.99 pr
MB1521360 1971-74 laagoon blue..... 164.99 pr
MB1521434 1971-74 dk metallic green..... 164.99 pr
MB1521444 1971-74 dark green..... 164.99 pr
MB1521450 1971-74 jade green..... 164.99 pr
MB1521664 1971-74 brown..... 164.99 pr
MB1521666 1971-74 ember gold..... 164.99 pr

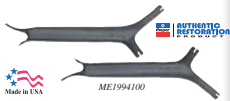

AUTHENTIC REPRODUCTION

Made in USA

ME1994100

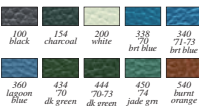

100 black 154 charcoal 200 white 338 70 brt blue 340 71-73 brt blue
360 laagoon blue 434 70 dk green 444 70-73 dk green 450 74 jade green 540 burnt orange
550 red 656 70 brn 664 71 brn ember gold 666 gold

1968-74 B & E-Body Pillar Post Molding

Replacement pillar post moldings for 1968-70 B-Body and 1970-74 E-Body models. Made with vacuum formed plastic, these pillar post moldings are molded in your choice of black or white or can also be ordered in a variety of factory dyed colors to match your upholstery. B-Body moldings available only in black. Made in USA. Important: The black and white moldings feature molded-in color and can be installed as-is. However, for show quality vehicles, additional preparation and painting may be required to eliminate tooling marks and any small scratches molded into the plastic. Colors other than black or white have been prepped and dyed at the factory and should require no additional preparation prior to installation.

Note: *Please add three digit color code when ordering.

1968-70 B-Body

MB1850 1968-70 2 door coupe, black ordering..... 164.99 pr

MB1851 1968-70 convertible, black... 229.99 pr

1970-74 E-Body

ME1994 1970-74 black or white..... 99.99 pr

ME2994 1970-74 factory colors..... 124.99 pr

Excellent for Securing Headliners and Vinyl Trim!

3M® Super Trim Adhesive

This is a fast acting, high strength aerosol contact adhesive designed for two surface application. This adhesive is resistant to heat and plasticizing oils, and is excellent for attaching vinyl tops, headliners, vinyl trim, insulation, foam padding and rubber parts to metal and other surfaces.

Note: Due to current FAA regulations all aerosol spray cans must be shipped ground delivery.
08D90 18 oz. aerosol..... 21.99 ea



Trim Removal Tools

Unique tools designed to remove door panels and moldings from interior panels. Safe and easily remove the door panels in your classic Mopar with these specially designed tools!

Trim Clip Removal Tool

Y35350 door panel remover..... 14.99 ea

Trim Molding Removal Tool

A7999 trim removal tool..... 9.99 ea

Dodge & Plymouth Sun Visors



ME1441300

1963-76 Sun Visors

Hand-sewn and padded replacement vinyl sun visors. Manufactured in a variety of original style upholstery grains and colors to perfectly match or accent your interior. Does not include support and metal rod as these are the padded vinyl portion of the sun visor only. Made in USA.

Note: Please add three-digit color code when ordering.

Bison Grain Vinyl

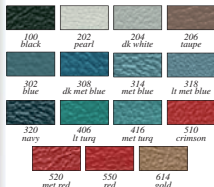

1964-65 A-Body - Bison Grain

Offered in black, dark white, metallic blue, red and gold.

MA3441 1964-65 Barracuda fastback 109.99 pr

1963-65 Dart & Valiant

Offered in black, pearl white, dark white, taupe, blue, dark metallic blue, metallic blue, turquoise, crimson, metallic red, red and gold.

MA1440 1963-65 sedans & hardtops 109.99 pr

MA1441 1963-65 convertible 109.99 pr

1963-65 B-Body - Bison Grain

1963 Polara 500

Offered in black, pearl, dark white, taupe, blue, light metallic blue, light turquoise, metallic turquoise and crimson.

MB1442 1963 hardtop or conv. 109.99 pr

1963-64 Polara

Offered in black, pearl, dark white, taupe, blue, light metallic blue, light turquoise, metallic turquoise and crimson.

MB1441 1963-64 Polara hardtop 109.99 pr

MB1445 1963-64 Polara convertible 109.99 pr

1963-64 Belvedere, Fury, Sport Fury

Offered in black (100) and dark white (204).

MB2441 1963-64 hardtops 109.99 pr

MB8442 1963 convertibles 109.99 pr

MB8444 1964 convertibles 109.99 pr

1965 Belvedere II, Satellite

Offered in black, dark white, blue, navy, metallic turquoise, crimson and gold.

MB2442 1965 hardtops 109.99 pr

MB3449 1965 convertibles 109.99 pr

1965 Coronet Convertible

Offered in black, pearl white, dark white, metallic blue and metallic red.

MB5445 1965 Coronet convertible 109.99 pr

Cologne Grain Vinyl

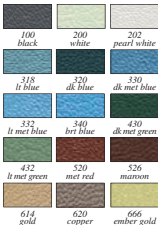

1966-68 A-Body - Cologne Grain

Offered in black, pearl, dark white and navy.

1966 Barracuda MA4447 1966 fastback 109.99 pr

1967-68 Barracuda

Offered in black, white, pearl, navy, dark metallic blue, blue, dark green, red, maroon and copper.

MA3442 notebucks and fastbacks 109.99 pr

MA3448 convertibles 109.99 pr

1966 Dart & Valiant

Offered in black, white, pearl, light blue, navy and gold.

MA1451 sedans and hardtops 109.99 pr

MA1450 convertibles 109.99 pr

1967-68 Dart

Offered in black, white, pearl, navy, dark metallic blue, blue, dark green, light metallic green, red, maroon and copper.

1967-68 Dart Sedan or Hardtop

MA1442 Cologne grain vinyl 109.99 pr

MA1447 Cologne grain vinyl 109.99 pr

1966-73 B-Body - Cologne Grain

1966 Belvedere II, Satellite

Offered in black, white, light blue, metallic red, and gold.

MB1443 1966 sedans 109.99 pr

MB2447 1966 2 door hardtops 109.99 pr

MB1451 1966 convertibles 109.99 pr

1966-67 Charger

Offered in black, white, pearl white, dark blue, metallic red, gold and copper.

MB4441 1966-67 Chargers 109.99 pr

1966-67 Coronet

Offered in black, white, pearl white, light blue, dark blue, metallic red, gold and copper.

MB3441 1966-67 sedans or hardtops 109.99 pr

MB1449 1966 convertibles 109.99 pr

MB1447 1967 convertibles 109.99 pr

1967 Belvedere, GTX, Satellite

Offered in black, white, pearl white, light blue, dark blue, metallic red and copper.

MB2447 1967 hardtops 109.99 pr

MB2451 1967 convertibles 109.99 pr

1968 Coronet & Super Bee

Offered in black, white, pearl white, dark blue, light blue, dark green, light green, red and maroon.

MB3441 1968 sedans or hardtops 109.99 pr

MB3448 1968 convertibles 109.99 pr

1972-73 Charger

Offered in black, white, pearl white, bright blue, dark green and gold.

MB4445 1972-73 Chargers 109.99 pr

1972-73 Road Runner, Satellite

Offered in black, white, bright blue and gold.

MB4444 1972-73 Rd Runner, Satellite 109.99 pr

Coachman Grain Vinyl

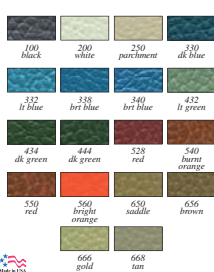

1969 A-Body - Coachman Grain

1969 Barracuda

Offered in black, white, dark metallic blue, light metallic blue, green, red and saddle.

MA1443 notebuck or fastback 109.99 pr

MA2450 convertible 109.99 pr

1969 Dart

Offered in black, white, dark metallic blue, light metallic blue, bright blue, green, red and saddle.

MA1443 sedan or hardtop 109.99 pr

MA1448 convertible 109.99 pr

1970-71 A-Body - Coachman Grain

Offered in black, white, dark metallic blue, light metallic blue, bright blue, green, red*, bright orange*, brown*, ember gold and tan*

MA2441 Coachman grain vinyl 109.99 pr

1971 Demon

MA2441 Coachman grain vinyl 109.99 pr

1971 Dart Swinger

MA1444 Coachman grain vinyl 109.99 pr

1972-76 A-Body - Coachman Grain

Offered in black, white, parchment, bright blue*, dark green* and ember gold*.

Note: *Color not offered for bucket seat models.

1972-73 Dart/Duster, 1972 Demon w/Bench

MA1445 Coachman grain vinyl 109.99 pr

1972-73 Dart/Duster, 1972 Demon w/Buckets

MA2442 Coachman grain vinyl 109.99 pr

1974-76 Dart or Duster w/Bucket Seats

MA2442 Coachman grain vinyl 109.99 pr

1969-73 B-Body - Coachman Grain

1969-70 Charger

Offered in black, white, dark blue bright blue, dark green, red, burnt orange, saddle and brown.

MB3443 1969-70 109.99 pr

1969-70 Coronet & Super Bee

Offered in black, white, dark blue, light blue, light green*, dark green*, red*, burnt orange, saddle and brown.

Note: *Colors with an asterisk are not offered for convertibles.

MB2443 1969-70 sedans or hardtops 109.99 pr

MB1446 1969-70 convertibles 109.99 pr

1969-70 GTX, Road Runner, Satellite

Offered in black, white, dark blue, light blue, light green, dark green, red, burnt orange, saddle and brown.

MB5442 1969-70 sedans or hardtops 109.99 pr

MB5449 1969-70 convertibles 109.99 pr

1971 Charger

Offered in black, white, bright blue, dark green and gold.

MB4448 1971 109.99 pr

A INTERIOR COMPONENTS



Dodge & Plymouth Sun Visors



MB344200

Coachman Grain Vinyl Cont'd

1971-73 GTX, Road Runner, Satellite
Offered in black, white, parchment*, light blue*, bright blue, dark green, bright orange*, gold and tan*.
Note: *Colors are not offered for 1972-73.

MB4443 1971..... 109.99 pr
MD4445 1972-73..... 109.99 pr

1972-73 Charger

Offered in black, white, parchment, bright blue, dark green and gold.

MB4446 1972-73..... 109.99 pr

1970-73 E-Body Coachman Grain

1970-71 Barracuda/Cuda
Offered in black, white, bright blue*, bright blue**, dark green*, red, burnt orange, bright orange, brown*, gold and tan.

Note: *Indicates a 1970-only color. **Indicates a 1971-only color.

ME1444 1970-71 coupe..... 109.99 pr
ME1446 1970-71 convertible..... 109.99 pr

1970-71 Challenger

Offered in black, white, bright blue*, bright blue**, dark green*, red, burnt orange, bright orange, brown*, gold and tan.

Note: *Indicates a 1970-only color. **Indicates a 1971-only color.

ME1444 1970-71 coupe..... 109.99 pr
ME2444 1970-71 convertible..... 109.99 pr

1972-73 Barracuda/Cuda

Offered in black, white, bright blue, dark green and gold.

ME1449 1972-73 coupe..... 109.99 pr

1972-73 Challenger

Offered in black, white, bright blue, dark green and gold.

ME1443 1972-73 coupe..... 109.99 pr

Tier Grain Vinyl

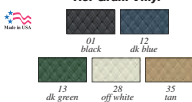

Foam Backed Cloth

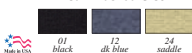

1972-76 A-Body Foam Backed Sun Visors

These foam-backed replacement sun visors are designed to match our replacement board-style headliners. Your choice of Tier grain vinyl or cloth in a variety of colors to match or accent your interior.

Note: Please add two digit color code when ordering.

1972-76 Demon, Duster, Dart Sport
MD37930 Tier grain vinyl..... 88.99 pr
MD37980 cloth..... 88.99 pr

1973-76 Dart Swinger, Valiant Scamp
MD37630 Tier grain vinyl..... 88.99 pr
MD37680 cloth..... 88.99 pr

Premier Perforated Vinyl

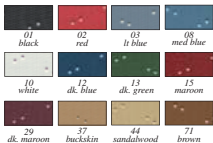

1963-65 A-Body - Perforated Grain

1963-65 Dart & Valiant

MD3461 1963-65 sedan or hardtop..... 88.99 pr

1963-65 B-Body - Perforated Grain

1963-64 Polara Hardtop

Offered in black, white, red, light blue, medium blue, dark blue, buckskin, sandalwood, brown, dark green, maroon and dark maroon.

MD3461 1963-64 Polara hardtop..... 88.99 pr

1965 Coronet

Offered in black, white, red, light blue, medium blue, dark blue, buckskin, sandalwood, dark green and maroon.

MB1448 1965 Coronet hardtop..... 94.99 pr

Premier Non-Perforated Vinyl



1965 Coronet - Non-Perforated Grain

Offered in black, white, red, lt. blue, medium blue, dark blue, buckskin, sandalwood, dark green and maroon.

MB3444 1965 Coronet hardtop..... 109.99 pr

Oxford grain

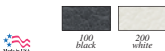

1974-76 A-Body - Non-Perforated Grain

Replacement style sun visors that will fit and function as original for 1974-76 model Darts and Dusters. May vary slightly from the original in appearance, but are perfect for the daily driver or mild custom when 100% originality is not a concern.

1974 Dart w/Bench Seat
MA1446 1974 Oxford grain vinyl..... 109.99 pr

1974 B-Body - Non-Perforated Grain

1974 Charger

Offered in black and white.

MB4447 1974 Chargers..... 109.99 pr

1974 Road Runner, Satellite

Offered in black and white.

MB4450 1974 Road Runner, Satellite..... 109.99 pr

1974 E-Body - Non-Perforated Grain

1974 Barracuda/Cuda, Challenger

ME1445 1974 coupe..... 109.99 pr



1962-65 B-Body Sun Visor Tips

Replacement Delrin plastic sun visor tips for 1962-65 B-Body vehicles.

MD313 1962-65..... 17.99 pr



1966-74 Sun Visor Tips

Replacement sun visor tips for 1966-74 A-Body, B-Body, and E-Body models. Fit on the end of the sun visor support rod and help keep sun visor in the sun visor retainer. Includes one pair of tips to fit any vehicle equipped with 2-pin sun visors and center-mounted sun visor retainers located above the rearview mirror.

MD314 1966-74..... 2.99 pr



1970-71 E-Body Convertible Sun Visor Plates

Replacement sun visor mounting plates for 1970-71 Barracuda, Cuda and Challenger convertibles. Features include correct satin finish and "cup-type" spring steel tensioners for the sun visor rod. Fits E-Body convertibles including Barracuda, Cuda and Challenger. Sold as a pair.

ME1273 1970-71..... 239.99 pr



1970-71 E-Body Sun Visor Bracket Cover

Replacement sun visor bracket covers for 1970-71 E-Body vehicles including Barracuda, Cuda and Challenger. Available exclusively in black, but can be painted to match your interior using OER* interior paint (sold separately). Made in USA.

ME1274 1970-71..... 36.99 pr



INTERIOR COMPONENTS

OE Style Replacement Sun Visors

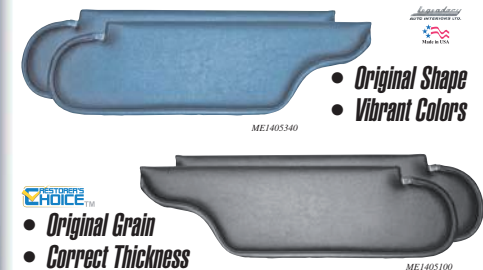

• **Original Shape**
• **Vibrant Colors**

ME1405340

ME1405100



- **Original Grain**
- **Correct Thickness**

Original Style Replacement Sun Visors

A first for the Mopar industry, Legendary Auto Interiors® has gone the extra mile to produce correct looking Mopar sun visors down to the smallest detail. These sun visors feature the year-correct Crosshatch, Cologne, Coachman or Oxford grain vinyl, original shape, correct thickness, and colors more vibrant than the other replacement sun visors on the market.

Note: Please specify color when ordering.

No further discounts apply.

A-Body

1965-66 A-Body exc. 1966 Dart Valiant - Crosshatch Grain	
MA1410101* 1965-66	black 191.99 pr
MA1410102* 1965-66	white 191.99 pr
MA1410111* 1965-66	blue 191.99 pr
MA1410121* 1965-66	red 191.99 pr
1966 Dart Valiant Hardtop - Cologne Grain	
MA1411100 1966	black 144.99 pr
MA1411200 1966	white 144.99 pr
MA1411318 1966	lt. met blue 144.99 pr
MA1411505 1966	red 144.99 pr
MA1411614 1966	gold 144.99 pr
1967-68 A-Body - Cologne Grain	
MD1412100 1967-68	black 144.99 pr
MD1412202 1967-68	pearl 144.99 pr
MD1412318 1967-68	lt. met blue 144.99 pr
MD1412320 1967-68	met navy 144.99 pr
MD1412322 1968	lt. met blue 144.99 pr
MD1412414 1967-68	dk met turquoise 144.99 pr
MD1412430 1968	dk met green 144.99 pr
MD1412520 1967-68	red 144.99 pr
MD1412526 1968	met navy 144.99 pr
MD1412618 1967-68	lt. gold 259.99 pr
MD1412620 1967-68	copper 144.99 pr
MD1412622 1967-68	dk met brown 144.99 pr
MD1412634 1968	lt. met fawn 144.99 pr
MD1412636 1968	ember gold 144.99 pr
1969 Dart, Dart GT Hardtop - Coachman Grain	
MA1413100 1969	black 144.99 pr
MA1413202 1969	pearl white 144.99 pr
MA1413332 1969	lt. met blue 144.99 pr
MA1413432 1969	lt. met green 144.99 pr
MA1413507 1969	red 144.99 pr
1969 Dart, Dart GT Convertible - Coachman Grain	
MA1414100 1969	black 144.99 pr
MA1414202 1969	pearl white 144.99 pr
MA1414332 1969	lt. met blue 144.99 pr
MA1414432 1969	lt. met green 144.99 pr
MA1414507 1969	red 144.99 pr
1969-71 A-Body - Coachman Grain	
MD1415100 1969-71	black 144.99 pr
MD1415200 1969-71	white 144.99 pr

MD1415330 1969-71	dk met blue 144.99 pr
MD1415338 1969-71	bright blue 144.99 pr
MD1415432 1969-71	lt. met green 144.99 pr
MD1415434 1969-71	dk met green 144.99 pr
MD1415528 1969-71	red 144.99 pr
MD1415630 1969	gold 144.99 pr
MD1415650 1969	saddle 144.99 pr
MD1415656 1969	brown 144.99 pr
MD1415666 1971	ember gold 144.99 pr
1970 Duster - Coachman Grain	
MA1416100 1970	black 144.99 pr
MA1416200 1970	white 144.99 pr
MA1416330 1970	dk met blue 144.99 pr
MA1416434 1970	dk met green 144.99 pr
MA1416530 1970	red 144.99 pr
MA1416656 1970	brown 144.99 pr
1971 Duster, Demon - Coachman Grain	
MA1417100 1971	black 144.99 pr
MA1417330 1971	dk met blue 144.99 pr
MA1417452 1971	dk met green 144.99 pr
MA1417560 1971	bright orange 144.99 pr
MA1417664 1971	brown 144.99 pr
MA1417666 1971	ember gold 144.99 pr
1972-73 Dart Hardtop - Coachman Grain	
MA1418100 1972-73	black 144.99 pr
MA1418200 1972-73	white 144.99 pr
MA1418250 1972-73	parment 144.99 pr
MA1418340 1972-73	bright blue 144.99 pr
MA1418444 1972-73	dk green 144.99 pr
MA1418666 1972-73	ember gold 144.99 pr
MA1418671 1972-73	honey gold 144.99 pr
MA1418672 1972-73	NOS honey gold 259.99 pr
1972 Duster, Duster - Coachman Grain	
MA1419100 1972	black 144.99 pr
MA1419200 1972	white 144.99 pr
MA1419340 1972	bright blue 144.99 pr
MA1419444 1972	dk green 144.99 pr
MA1419666 1972	ember gold 144.99 pr
1973 Duster, Dart Sport - Coachman Grain	
MA1420100 1973	black 144.99 pr
MA1420200 1973	white 144.99 pr
MA1420250 1973	parment 144.99 pr
MA1420340 1973	bright blue 144.99 pr
MA1420444 1973	dark green 144.99 pr
MA1420671 1973	honey gold 144.99 pr
MA1420672 1973	NOS honey gold 259.99 pr
1974-76 Duster, Dart Sport - Oxford Grain	
MA1421100 1974-76	black 144.99 pr
MA1421200 1974-76	white 144.99 pr
MA1421264 1974-76	NOS parment 265.99 pr
MA1421360 1974-76	lagoon blue 144.99 pr
MA1421450 1974-76	jade green 144.99 pr
MA1421453 1974-76	NOS green 259.99 pr
MA1421680 1974-76	NOS gold 259.99 pr

Coachman Grain

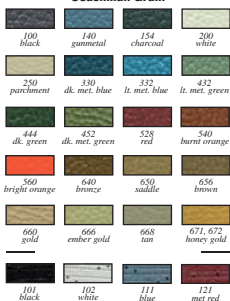

1974-76 Dart, Scamp Hardtop - Oxford Grain

MA1422100 1974-76	black 144.99 pr
MA1422264 1974-76	NOS parment 265.99 pr
MA1422360 1974-76	lagoon blue 144.99 pr
MA1422450 1974-76	jade green 144.99 pr
MA1422453* 1976	NOS lt. green 259.99 pr
MA1422680* 1974-75	NOS gold 259.99 pr

B-Body

1965 B-Body Hardtop - Crosshatch Grain	
MB1412101* 1965	black 211.99 pr
MB1412102* 1965	white 211.99 pr
MB1412111* 1965	blue 211.99 pr
MB1412121* 1965	red 211.99 pr
1966-67 B-Body Hardtop - Cologne Grain	
MB1413100 1966-67	black 144.99 pr
MB1413202 1966-67	pearl white 144.99 pr
MB1413318 1966	lt. met blue 144.99 pr
MB1413320 1966-67	met navy 144.99 pr
MB1413420 1966	citron 144.99 pr
MB1413520 1966	met red 144.99 pr
MB1413614 1966	gold 144.99 pr
MB1413620 1967	copper 144.99 pr
MB1413630 1967	gold 144.99 pr
1966-67 Charger - Cologne Grain	
MB1413100 1966-67	black 144.99 pr
MB1413202 1966-67	pearl white 144.99 pr
MB1413320 1966-67	met navy 144.99 pr
MB1413420 1966	citron 144.99 pr
MB1413520 1966-67	met red 144.99 pr
MB1413614 1966	gold 144.99 pr
MB1413620 1967	copper 144.99 pr
MB1413630 1967	gold 144.99 pr
1968 B-Body - Cologne Grain	
MD1412100 1967-68	black 144.99 pr
MD1412202 1967-68	pearl white 144.99 pr
MD1412330 1968	dk met blue 144.99 pr
MD1412332 1968	black 144.99 pr
MD1412430 1968	dk met green 144.99 pr
MD1412520 1967-68	met red 144.99 pr
1969-70 B-Body - Coachman Grain	
MD1415100 1969-71	black 144.99 pr
MD1415200 1969-71	white 144.99 pr
MD1415330 1969-70	dk met blue 144.99 pr
MD1415338 1969-70	bright blue 144.99 pr
MD1415432 1969-70	lt. met green 144.99 pr
MD1415434 1969-70	dk met green 144.99 pr
MD1415528 1969	red 144.99 pr
MD1415540 1969	burnt orange 144.99 pr
MD1415640 1969	bronze 144.99 pr
MD1415650 1969	saddle 144.99 pr
MD1415656 1970	brown 144.99 pr
1971-73 B-Body - Coachman Grain	
MB1416100 1971-73	black 144.99 pr
MB1416140 1971	gunmetal 144.99 pr

OE-Style Replacement Headliners

Cologne Grain

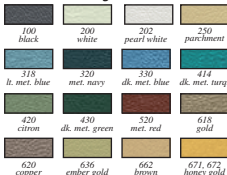

Oxford Grain

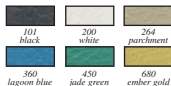

MB1416200	1971-72	white	144.99	pr
MB1416250	1973	parchment	144.99	pr
MB1416332	1971	lt. met. blue	144.99	pr
MB1416340	1971-73	bright blue	144.99	pr
MB1416432	1971-73	lt. green	144.99	pr
MB1416444	1972-73	dk green	144.99	pr
MB1416452	1971	dk met green	144.99	pr
MB1416662	1972	brown	144.99	pr
MB1416664	1971	brown	144.99	pr
MB1416666	1971-72	ember gold	144.99	pr
MB1416668	1971-73	tan	144.99	pr
MB1416671	1973	honey gold	144.99	pr
MB1416672	1973	NOS honey gold	259.99	pr

1972-73 B-Body - Cologne Grain

MB1417100	1972-73	black	144.99	pr
MB1417200	1972	white	144.99	pr
MB1417250	1973	parchment	144.99	pr
MB1417340	1972-73	bright blue	144.99	pr
MB1417444	1972-73	dk green	144.99	pr
MB1417662	1972	brown	144.99	pr
MB1417666	1972	ember gold	144.99	pr
MB1417671	1973	honey gold	144.99	pr
MB1417672	1973	NOS honey gold	259.99	pr

1974 B-Body - Oxford Grain

MB1418100	1974	black	144.99	pr
MB1418200	1974	white	144.99	pr
MB1418264	1974	NOS parchment	265.99	pr
MB1418360	1974	lagoon blue	144.99	pr
MB1418450	1974	jade green	144.99	pr
MB1418680	1974	NOS ember gold	259.99	pr

E-Body

1970-71 E-Body Hardtop - Coachman Grain

ME1405100	1970-71	black	144.99	pr
ME1405154	1970-71	charcoal	144.99	pr
ME1405200	1970-71	white	144.99	pr
ME1405338	1970	bright blue	144.99	pr
ME1405340	1971	bright blue	144.99	pr
ME1405344	1970	dk met green	144.99	pr
ME1405452	1971	dk met green	144.99	pr
ME1405540	1970	burnt orange	144.99	pr
ME1405550	1970	red	144.99	pr
ME1405562	1970	brown	144.99	pr
ME1405664	1971	brown	144.99	pr
ME1405666	1970-71	ember gold	144.99	pr

1972-73 E-Body - Coachman Grain

ME1406100	1972-73	black	144.99	pr
ME1406200	1972-73	white	144.99	pr
ME1406340	1972-73	bright blue	144.99	pr
ME1406444	1972-73	dk green	144.99	pr
ME1406666	1972-73	ember gold	144.99	pr

1974 E-Body - Oxford Grain

ME1407100	1974	black	144.99	pr
ME1407200	1974	white	144.99	pr
ME1407360	1974	lagoon blue	144.99	pr
ME1407450	1974	jade green	144.99	pr

A first for the Mopar industry, Legendary Auto Interiors® has gone the extra mile to produce original style Mopar headliners and sail panels with careful attention paid to the smallest detail.



1965-66 Crosshatch Grain (Headliners Only)

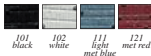

1969-72 Fine Pembrok Grain

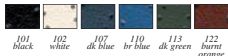

1964-76 OE Style Headliners

These headliners feature year-correct Crosshatch or Fine Pembrok grain, heavy cotton/poly cloth backing and colors more vibrant than other headliners on the market. **Important:** Crosshatch grain vinyl is specific to 1965-66 applications and Fine Pembrok vinyl is specific to 1969-72 application. These headliners may not be cosmetically correct for other year applications. **Note:** Please add three digit color code when ordering. No further discounts apply.

A-Body

Perforated Crosshatch Grain

Barracuda Fastback	MA1401 1964-66	221.99	ea
Valiant Signet Hardtop	MA1402 1965	221.99	ea
MA1403 1966	221.99	ea	

Perforated Fine Pembrok

Dart, Dart G Hardtop	MA1404 1967-76	174.99	ea
Valiant 2 & 4 Door Sedan	MA1405 1967-72	174.99	ea

Barracuda

MA1406 1967-69	hardtop	174.99	ea
MA1407 1967-69	fastback	174.99	ea

Demon, Duster

MA1408 1970-71	6 bow	174.99	ea
Duster, Demon, Dart Sport	MA1409 1971-74	174.99	ea

B-Body

Perforated Crosshatch Grain

Coronet 440 & 500	MB1401 1965	hardtop	221.99	ea
Coronet, Belvedere II, Satellite, GTX	MB1402 1966-67	hardtop	221.99	ea
Coronet, Belvedere 2 & 4 Door Sedan	MB1403 1966-67	4 bow	221.99	ea
MB1404 1966-67	5 bow	221.99	ea	

Perforated Fine Pembrok

Coronet, Road Runner, Satellite, GTX

MB1405 1968	hardtop	174.99	ea
-------------	---------	--------	----

Charger (excl Charger 500 & Daytona)

MB1405 1968-70	174.99	ea
----------------	--------	----

Charger 500 and Daytona

MB1407 1969	174.99	ea
-------------	--------	----

Coronet, Road Runner, Satellite, GTX

MB1408 1969-70	174.99	ea
----------------	--------	----

Supercid

MB1409 1970	174.99	ea
-------------	--------	----

Charger, Road Runner, Satellite, GTX

MB1410 1971-74	4 bow	174.99	ea
MB1411 1971-74	6 bow	174.99	ea

B-Body

Perforated Fine Pembrok

Barracuda, Cuda	ME1401 1970-71	5 bow	174.99	ea
ME1402 1971-74	4 bow	174.99	ea	

Challenger

ME1403 1970-71	5 bow	174.99	ea
ME1404 1971-74	4 bow	174.99	ea

1969-72 OE Style Replacement Sail Panels

These sail panels feature the year-correct Fine Pembrok grain, heavy cotton/poly cloth backing, and colors more vibrant than other sail panels on the market. **Note:** Refer to the Fine Pembrok Grain swatches above for color options. Please add three digit color code when ordering. No further discounts apply.

ME1409102

A-Body

Dart, Dart G Hardtop

MA1426101 1969-72	black	84.99	pr
MA1426102 1969-72	white	84.99	pr
MA1426107 1969-72	dark blue	84.99	pr
MA1426110 1969-72	bright blue	84.99	pr
MA1426113 1969-72	dark green	84.99	pr

Duster

MA1427101 1970-72	black	84.99	pr
MA1427102 1970-72	white	84.99	pr
MA1427107 1970-72	dark blue	84.99	pr
MA1427110 1970-72	bright blue	84.99	pr
MA1427113 1970-72	dark green	84.99	pr
MA1427122 1970-72	burnt orange	77.99	pr

B-Body

Coronet, Road Runner, Satellite, GTX

MB1421101 1969-70	black	84.99	pr
MB1421102 1969-70	white	84.99	pr
MB1421107 1969-70	dark blue	84.99	pr
MB1421110 1969-70	bright blue	84.99	pr
MB1421113 1969-70	dark green	84.99	pr
MB1421122 1969-70	burnt orange	84.99	pr

Road Runner, Satellite, GTX

MB1422101 1971-72	black	84.99	pr
MB1422107 1971-72	white	84.99	pr
MB1422110 1971-72	dark blue	84.99	pr
MB1422113 1971-72	bright blue	84.99	pr
MB1422117 1971-72	dark green	84.99	pr

Charger

MB1423101 1971-72	black	84.99	pr
MB1423102 1971-72	white	84.99	pr
MB1423107 1971-72	dark blue	84.99	pr
MB1423110 1971-72	bright blue	84.99	pr
MB1423113 1971-72	dark green	84.99	pr

E-Body

Barracuda, Cuda

ME1409101 1970-72	black	84.99	pr
ME1409102 1970-72	white	84.99	pr
ME1409107 1970-72	dark blue	84.99	pr
ME1409110 1970-72	bright blue	84.99	pr
ME1409113 1970-72	dark green	84.99	pr
ME1409122 1970-72	burnt orange	84.99	pr

Challenger (except SE models)

ME18169 1970-72	uncovered	27.99	pr
-----------------	-----------	-------	----

Sail Panels & Rear View Mirrors



MAR162303



MES562613

1963-76 A/B/E-Body Sail Panels

Sail panels mount below the rear portion of the headliner in between the quarter glass and the back window. Available covered in Premier grain vinyl or as a plain uncovered panel if your replacement headliner kit includes sail panel material. Please specify the two-digit code when ordering covered panels. Sold as a pair. Made in USA.

Premier Perforated Vinyl



1963-75 A-Body

Offered in black, white, light blue, medium blue, dark blue, dark green, red, maroon, sandalwood, brown and buckskin. Premier perforated vinyl.

Perforated Premier Grain Sail Panels

MAR1621 1963-66 Dart 2 dr hardtop	39.99 pr
MAR1623 1967-70 Dart 2 dr hardtop	39.99 pr
MAR1623 1971-75 Swinger, Scamp	39.99 pr
MAR1628 1970-71 Duster	39.99 pr
MAR1628 1971 Demon	39.99 pr

1966-74 B-Body

Offered in black, off white, medium blue, dark blue, dark green, red, light saddle and brown. Premier grain vinyl.

Perforated Premier Grain Sail Panels

MBS2620 1966-67 2 door hardtop	39.99 pr
MBS2621 1968 2 door hardtop	39.99 pr
MBS4624 1968-70 Charger	39.99 pr
MBS2624 1969-70 2 door hardtop	39.99 pr
MBS2626 1971 2 door hardtop	39.99 pr
MBS4627 1971 Charger	39.99 pr
MBS2626 1972-74 2 door hardtop	39.99 pr

1970-74 E-Body

Offered in black, off white, medium blue, dark blue, dark green, red, light saddle and brown. Premier grain vinyl.

Perforated Premier Grain Sail Panels

MES5626 1970-71 Barracuda or 'Cuda	39.99 pr
MES5620 1970-71 Challenger (w/o SE)	39.99 pr

Premier Non-Perforated Vinyl

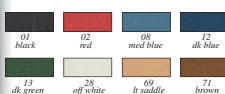

1973-74 B-Body

Premier Grain Vinyl Sail Panels

MBS4629 1973-74 Charger SE	39.99 pr
MBS4630 1973-74 Charger SE	39.99 pr

1972-74 E-Body

Premier Grain Vinyl Sail Panels

MES5627 1972-74 Barracuda or 'Cuda	39.99 pr
MES5621 1972-74 Challenger (w/o SE)	39.99 pr

Tier Grain Vinyl



1972-76 A-Body

Tier Grain Vinyl Sail Panels

MA1630 1973-76 Swinger, Scamp	49.99 pr
MA1730 1972-73 Demon/D Sport, Duster	49.99 pr

Foam Backed Cloth

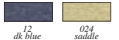

1972-76 A-Body

Cloth Sail Panels

MA1680 1973-76 Swinger, Scamp	49.99 pr
MA1780 1972-73 Demon/D Sprt, Duster	49.99 pr

Sail Panel Boards

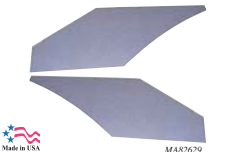

Made in USA

MAR2629

1963-76 A-Body

Uncovered Panels - Boards Only

MAR81624 1963-66 Dart 2 door hardtop	19.99 pr
MAR8269 1967-69 Barracuda notchback	19.99 pr
MAR1622 1967-70 Dart 2 door hardtop	19.99 pr
MAR1622 1971-72 Swinger, Scamp	19.99 pr
MAR1630 1970-71 Duster	19.99 pr
MAR1630 1971-72 Demon	19.99 pr
MAR831 1973-76 Swinger, Scamp	29.99 pr
MAR3632 1973-76 Demon/Drt Sprt, Duster	29.99 pr

1965-74 B-Body 2 Door Hardtop

Uncovered Panels - Boards Only

MBS1634 1965 B-Body 2 dr hardtop	19.99 pr
MBS2622 1966-67 B-Body 2 dr hardtop	19.99 pr
MBS2627 1968 B-Body 2 dr hardtop	19.99 pr
MBS4623 1968-70 Charger	19.99 pr
MBS2623 1969-70 B-Body 2 dr hardtop	19.99 pr
MBS2625 1971 B-Body 2 dr hardtop	19.99 pr
MBS4625 1971 Charger	19.99 pr
MBS2625 1972-74 B-Body 2 dr hardtop	19.99 pr
MBS4625 1973-74 Charger	19.99 pr
MBS4626 1973-74 Charger SE	19.99 pr

1970-74 E-Body

Uncovered Panels - Boards Only

MAR81624 1970-74 Barracuda or 'Cuda	19.99 pr
MES5622 1970-74 Challenger (w/o SE)	19.99 pr
MES5623 1970 Challenger SE	19.99 pr



Rear View Mirror w/VFD Temp & Compass

This rear view mirror features an outdoor temperature indicator and a path point compass system to add modern convenience to any classic vehicle. The vacuum fluorescent digital display matches Dakota Digital instrument systems and shows compass and temperature readings simultaneously. Night vision safety feature provides auto-dimming feature to reduce glare. VFD compass/temperature mirror uses a universal glue-on style mount. Temperature range -31° to 131°F.
 DD10601 229.99 ea



MD7124



1968-74 Rear View Mirror

These beautiful reproduction rear view mirrors were designed to replace missing or damaged mirror originals. Mounts in the factory location.

MD7124 1968-69 A-Body	79.99 ea
MF1751 1968-70 B-Body	99.99 ea
MF1751 1970-71 A-Body	99.99 ea
MD7125 1970-71 B-Body	79.99 ea
MF1752 1971-74 B, E-Body	99.99 ea



1972-74 Day/Night Rear View Mirror

Reproduction day/night rear view mirror for 1972-74 A/E-Body models. These mirrors have a day/night feature that helps prevent glare from the lights of vehicles behind you.
 MF1755 1972-74 A-Body 99.99 ea
 MF1755 1972-74 E-Body 99.99 ea

1970-71 E-Body Rear View Mirror Bracket

Replacement rear view mirror bracket for 1970-71 E-Body convertibles. This is the bracket for mounting the rear view mirror to the windshield frame. For convertible models only.
 ME756 1970-71 E-Body convertible. 104.99 ea



1970-71 E-Body Rear View Mirror Bezel

Replacement rear view mirror bezel for 1970-71 E-Body convertibles. This molded bezel attaches to the mirror base to cover the screws for a finished appearance. Replace the faded, broken or missing bezel in your vehicle for a factory fresh look.
 ME755 1970-71 E-Body convertible. 114.99 ea



Interior Screw Sets

Be sure to have the correct fasteners on hand when you put your interior back together with our convenient screw sets!



1963-75 Interior Screw Sets

Tempted to substitute a fastener with an incorrect head, thread or washer design because you've lost the originals and can't find the correct replacement? Spending too much time searching for and cleaning up rusty or dirty original fasteners? Don't cut corners or waste valuable time when it comes to fasteners. Purchase the set from Classic Industries® and rest assured that you have the correct fastener on hand when it's time to put your interior back together. Our handy interior screw kits contain most of the visible essential screws used for installing key items such as the brake release handle, interior mirror, pillar post moldings, coat hooks, dash panels, dome light, door frame, door seal, kick panels, light switch, quarter seals, seat latch, sill plates, sun visors, interior windshield moldings and more! Screw count and application will vary by model and year.

1963-75 A-Body

Barracuda	
MA101	1964-65 135 screws 45.99 set
MA103	1966 165 screws 29.99 set
MA102	1967 90 screws nothback coupe 49.99 set
MA104	1967 131 screws fastback 39.99 set
MA105	1967 83 screws convertible 29.99 set
MA106	1968-69 83 screws nothback coupe 29.99 set
MA107	1968-69 117 screws fastback 39.99 set
MA107	1968-69 83 screws convertible 29.99 set
Dart	
MA109	1963 65 screws 4 door sedan 24.99 set
MA990	1963 89 screws convertible 32.99 set
MA991	1964 83 screws 4 door sedan 29.99 set
MA992	1964 83 screws 270 convertible 29.99 set
MA113	1964 145 screws GT 2 door hardtop 44.99 set
MA114	1964 150 screws GT 2 door hardtop 49.99 set
MA115	1965 107 screws 2 door sedan 45.99 set
MA116	1965 105 screws 270 convertible 39.99 set
MA117	1965 141 screws GT 2 door hardtop 49.99 set
MA118	1966 106 screws 4 door sedan 47.99 set
MA119	1967-69 107 screws 2 door sedan or hardtop 34.99 set
MA120	1967-69 93 screws convertible 31.99 set
MA121	1970 106 screws 2 door hardtop 34.99 set
MA122	1970-74 65 screws 4 door sedan 23.99 set
Dart Swinger, Valiant Scamp	
MA123	1971-72 106 screws 2 door hardtop 26.99 set
MA124	1974-75 96 screws 2 door hardtop 34.99 set
Dart Sport, Demon, Duster	
MA125	1972 63 screws 2 door coupe 24.99 set
MA126	1974 98 screws 2 door coupe 34.99 set
Valiant	
MA127	1962 77 screws 4 door sedan 37.99 set
MA128	1963 98 screws Signet convertible 37.99 set
MA129	1963 95 screws Signet 2 door hardtop 35.99 set
MA130	1964 112 screws Signet 2 door hardtop 39.99 set
MA131	1964 83 screws convertible 29.99 set
MA132	1964-66 71 screws 2 door sedan 21.99 set
MA133	1967 55 screws 2 door sedan 21.99 set
MA134	1967 57 screws 4 door sedan 24.99 set
MA135	1968 66 screws Signet 4 door sedan 26.99 set



1964-67 B-Body

330, 440, Polara, Polara 500	
MB383	1963 101 screws 330 4 door sedan 36.99 set
MB202	1963 123 screws Polara 2 door hardtop 46.99 set
MB203	1963 113 screws Polara convertible 46.99 set
MB204	1964 147 screws Polara 500 2 door hardtop 53.99 set
MB205	1964 98 screws Polara convertible 34.99 set
Belvedere, GTX, Satellite	
MB206	1964 116 screws 2 door hardtop 41.99 set
MB207	1965 147 screws 2 door hardtop 49.99 set
MB208	1965 111 screws convertible 39.99 set
MB209	1966 116 screws 2 door hardtop 39.99 set
MB210	1966 97 screws convertible 34.99 set
MB211	1967 113 screws 2 door hardtop 34.99 set
MB212	1967 112 screws convertible 34.99 set
Belvedere II	
MB213	1965 107 screws 4 door sedan 39.99 set
MB214	1967 84 screws 4 door sedan 28.99 set
Charger	
MB215	1966-67 173 screws 2 door fastback 54.99 set
Coronet 440, 500	
MB216	1965 86 screws 440 4 door sedan 38.99 set
MB217	1965 116 screws 440 2 door hardtop 42.99 set
MB218	1965 138 screws 500 2 door hardtop 52.99 set
MB219	1965 138 screws 500 convertible 63.99 set
MB220	1966 101 screws 440 4 door sedan 37.99 set
MB221	1966 113 screws 500 2 door hardtop 41.99 set
MB222	1966 87 screws 440 & 500 convertible 31.99 set
MB223	1967 85 screws 440 4 door sedan 31.99 set
MB224	1967 98 screws 440 2 door hardtop 34.99 set
MB225	1967 103 screws 440 & 500 convertible 36.99 set
Sport Fury	
MB226	1963 102 screws convertible 36.99 set
MB227	1963 109 screws 2 door hardtop 41.99 set
MB228	1964 119 screws 2 door hardtop 42.99 set
MB229	1964 100 screws convertible 34.99 set
1968-74 B-Body	
Charger	
MB230	1968 97 screws 2 door hardtop 29.99 set
MB231	1969-70 114 screws 2 door hardtop 34.99 set
MB232	1971-74 106 screws R/T, Rallye 29.99 set
MB233	1971-74 84 screws SE 29.99 set
Coronet	
MB234	1968 102 screws 4 door sedan 37.99 set
MB235	1968 106 screws 2 door hardtop 34.99 set
MB236	1968 84 screws convertible 29.99 set
MB237	1969-70 114 screws 4 door sedan 42.99 set
MB238	1969-70 110 screws 440 & 500 2 door hardtop 39.99 set
MB239	1969-70 110 screws 440 & 500 convertible 38.99 set
GTX	
MB240	1968 118 screws 2 door hardtop 34.99 set
MB241	1968 101 screws convertible 34.99 set
MB242	1969-70 105 screws 2 door hardtop 34.99 set
MB243	1969-70 106 screws convertible 34.99 set
Road Runner	
MB244	1968 95 screws 2 door coupe 31.99 set
MB242	1969-70 105 screws 2 door coupe or hardtop 34.99 set
MB243	1969-70 106 screws convertible 34.99 set
MB245	1971-74 94 screws 2 door hardtop 33.99 set
Satellite	
MB384	1968 104 screws 2 door hardtop 34.99 set
MB241	1968 101 screws convertible 34.99 set
Super Bee	
MB242	1969-70 105 screws 2 door hardtop 34.99 set
MB243	1969-70 106 screws convertible 34.99 set
1970-74 E-Body	
Barracuda, Cuda, Challenger	
ME301	1970-74 148 screws 2 door hardtop 49.99 set
ME303	1970-74 129 screws convertible 44.99 set

1960-76 Package Trays



ME120612

ME100101

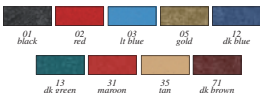

1960-76 Mopar Package Trays

Replace the rear package tray in your Mopar with a brand new die-cast package tray from Classic Industries®. These replacement package trays install inside the vehicle between the top of the rear seat and the rear window. Most trays are available as standard without speaker cutouts or as a deluxe tray with cutouts for speakers. These trays are manufactured to exacting standards with the highest quality materials and workmanship to offer a replacement panel that is as close to original as possible. Please specify color when ordering. Made in USA.

1960-76 A-Body

1960-62 Valiant	
Tray only available without speaker cutouts.	
MA1118 1960-61	w/o speaker cutouts 34.99 ea
MA1119 1962	w/o speaker cutouts 34.99 ea
1963-64 Dart GT 2 Door Hardtop	
MA1102 1963	w/o speaker cutouts 34.99 ea
MA1103 1964	with speaker cutouts 44.99 ea
1963-64 Dart 170, 270 Sedan	
Applications to fit 4 door sedans. Tray only available without speaker cutouts.	
MA1104 1963	w/o speaker cutouts 34.99 ea
MA1105 1964	w/o speaker cutouts 34.99 ea
1963-65 Valiant 2 Door Sedan	
Fits 2 door sedans with post. Tray only available without speaker cutouts.	
MA1120 1963-65	w/o speaker cutouts 34.99 ea
1963-65 Valiant Signet 2 Door Hardtop	
MA1121 1963-65	w/o speaker cutouts 34.99 ea
MA1122 1963-65	with speaker cutouts 44.99 ea
1965-66 Dart 270, Dart GT 2 Door Hardtop	
MA1106 1965-66	w/o speaker cutouts 34.99 ea
MA1107 1965-66	with speaker cutouts 44.99 ea
1966 Valiant Signet 2 Door Hardtop	
Tray only available without speaker cutouts.	
MA1123 1966	w/o speaker cutouts 34.99 ea
1967-68 Dart 2 Door Sedan	
Fits 2 door sedan models with post.	
MA1108 1967-68	w/o speaker cutouts 34.99 ea
MA1109 1967-68	with speaker cutouts 44.99 ea
1967-69 Barracuda Hardtop Coupe	
MA1100 1967-69	w/o speaker cutouts 34.99 ea
MA1101 1967-69	with speaker cutouts 44.99 ea
1967-69 Valiant	
Fits 2 door or 4 door sedans. Your choice of standard tray without speaker grill cutouts, deluxe tray with speaker grill cutouts or deluxe tray with speaker grill cutouts and rear window defroster cutouts.	
MA1124 1967-69	w/o speaker cutouts 34.99 ea
MA1125 1967-69	with speaker cutouts 44.99 ea
MA1126 1967-69	w/ speakers & defroster 44.99 ea
1967-76 Dart 2 Door Hardtop	
MA1110 1967-74	w/o speaker cutouts 34.99 ea
MA1111 1967-74	with speaker cutouts 44.99 ea
MA1116 1970-76	with speaker cutouts 44.99 ea

1975-76 Dart Swinger 2 Door Hardtop	
MA1112 1975-76	w/o speaker cutouts 34.99 ea
MA1113 1975-76	with speaker cutouts 44.99 ea
1974-76 Dart 4 Door Sedan	
MA1114 1974-76	w/o speaker cutouts 34.99 ea
MA1115 1974-76	with speaker cutouts 44.99 ea
1970-76 Demon, Dart Sport & Duster	
Fits 2 door coupe models with fixed rear seat including 1971-72 Demon, 1973-76 Dart Sport and 1970-76 Duster.	
With fixed rear seat	
MA1127 1970-76	w/o speaker cutouts 34.99 ea
MA1116 1970-76	with speaker cutouts 44.99 ea
With folding rear seat	
MA1117 1970-76	w/o speaker cutouts 54.99 ea

1962-74 B-Body

1962 Belvedere, Dart, Fury	
Tray only available without speaker cutouts.	
MB1200 1962	w/o speaker cutouts 34.99 ea
1963 Belvedere, Fury, Sport Fury 2 Door Hardtop	
MB1201 1963	w/o speaker cutouts 34.99 ea
MB1228 1963	with speaker cutouts 44.99 ea
1963 Dodge 330, 440, Polara 2 Door Sedan	
MB1202 1963	w/o speaker cutout 34.99 ea
MB1203 1963	with center speaker 44.99 ea
1963 Polara 500 2 Door Hardtop	
Tray only available without speaker cutouts.	
MB1204 1963	w/o speaker cutout 34.99 ea
1964-65 B-Body 2 Door Hardtop	
Your choice of standard tray without speaker grill cutouts, deluxe tray with dual stereo speaker grill cutouts or deluxe tray with single center mounted speaker cutout.	
MB1205 1964-65	w/o speaker cutout 34.99 ea
MB1206 1964-65	with dual speakers 44.99 ea
MB1207 1964-65	with single speaker 44.99 ea
1964-65 B-Body 2 Door Sedan & 4 Door	
MB1208 1964-65	w/o speaker cutout 34.99 ea
MB1209 1964-65	with dual speakers 44.99 ea
1964 Saway 2 Door Sedan	
Tray only available without speaker cutouts.	
MB1210 1964	w/o speaker cutout 34.99 ea
1966-67 B-Body 2 Door Hardtop	
MB1211 1966-67	w/o speakers or harness 34.99 ea
MB1212 1966-67	w/o speakers w/ harness 34.99 ea
MB1213 1966-67	with speaker cutouts 44.99 ea
MB1214 1966-67	w/ speakers & harness 44.99 ea
1966-67 Belvedere, Coronet Sedan	
Tray only available without speaker cutouts.	
MB1215 1966-67	w/o speaker cutout 34.99 ea
1968 Belvedere, Satellite 4 Door Sedan	
Fits 1968 Belvedere, Satellite 4 door sedan.	
MB1216 1968	w/o speaker cutout 34.99 ea
MB1217 1968	with speaker cutouts 44.99 ea
1968-70 Coronet, GTX, Road Runner, Satellite, Super Bee	
Fits 2 door hardtop models. Your choice of standard tray without speaker grill cutouts, deluxe tray with dual stereo speaker grill cutouts parallel to each other facing the same direction or deluxe tray with dual stereo speaker grill cutouts offset or in opposite directions (for rear window defroster).	
<i>Note: Models with rear window defroster use package tray with speaker cutouts located in opposite directions.</i>	
MB1218 1968-70	w/o speaker cutout 34.99 ea
MB1219 1968-70	with speakers 44.99 ea
MB1220 1968-70	w/ speakers w/ defroster 44.99 ea
1968-70 Charger Except 500 & Daytona	
MB1221 1968-70	w/o speaker cutout 34.99 ea
MB1222 1968-70	with speaker cutouts 44.99 ea
1969 Charger 500, Daytona	
<i>Note: Some minor cutting necessary to install on models with rear window defroster.</i>	
MB1223 1969	w/o speaker cutout 84.99 ea
MB1224 1969	with speaker cutouts 99.99 ea
1970 Superbird	
MB1225 1970	w/o speaker cutout 84.99 ea
1971-74 Charger, GTX, Road Runner, Satellite	
MB1226 1971-74	w/o speaker cutout 34.99 ea
MB1227 1971-74	with speaker cutouts 44.99 ea

1970-74 E-Body

1970-74 Barracuda, "Cuda Hardtop	
ME1000 1970-74	w/o speaker cutout 34.99 ea
ME1001 1970-74	with speaker cutouts 44.99 ea
1970-74 Challenger Hardtop	
ME1002 1970-74	w/o speaker cutout 34.99 ea
ME1003 1970-74	with speaker cutouts 44.99 ea

1960-74 Mopar Package Trays



MB1308



ME1010



MB571



1962-76 Package Tray Insulation

Reduce road noise, exhaust noise, heat and fumes in the passenger compartment by replacing or adding jute padding insulation beneath the package tray in your Mopar. Die-cut to fit your specific vehicle, these insulation pads are an inexpensive way to provide you and your passengers with a more comfortable atmosphere while driving.

A-Body Insulation

Model	Year	Configuration	Price
<i>Barracuda</i>	MA1200	1967-69 coupe (notchback)	19.99 ea
<i>Dart Hardtop</i>	MA1201	1963 2 door hardtop	19.99 ea
	MA1202	1964 2 door hardtop	19.99 ea
	MA1203	1965-66 2 door hardtop	19.99 ea
	MA1204	1967-74 2 door hardtop	19.99 ea
<i>Dart Sedan</i>	MA1205	1963 4 door sedan	19.99 ea
	MA1206	1964 4 door sedan	19.99 ea
	MA1207	1974-76 4 door sedan	19.99 ea
<i>Dart Sport</i>	MA1208	1973-76 w/fixed rear seat	19.99 ea
<i>Demon</i>	MA1208	1971-72 w/fixed rear seat	19.99 ea
<i>Duster</i>	MA1208	1970-76 w/fixed rear seat	19.99 ea
<i>Valiant Hardtop</i>	MA1209	1962 2 door hardtop	19.99 ea
	MA1210	1963-65 2 door hardtop	19.99 ea
	MA1211	1966 2 door hardtop	19.99 ea
<i>Valiant Sedan</i>	MA1212	1963-65 2 door sedan	19.99 ea
	MA1211	1966 2 door sedan	19.99 ea
	MA1213	1967-69 2/4 door sedan	19.99 ea

B-Body Insulation

<i>330, 440 Sedan</i>	MB1300	1963 2 door sedan	19.99 ea
<i>440 Hardtop</i>	MB1301	1964 2 door hardtop	19.99 ea
<i>Beldere Hardtop</i>	MB1302	1963 2 door hardtop	19.99 ea
	MB1301	1964 2 door hardtop	19.99 ea
	MB1303	1965 2 door hardtop	19.99 ea
	MB1304	1966-67 2 door hardtop	19.99 ea
<i>Beldere Sedan</i>	MB1305	1965 4 door sedan	19.99 ea
	MB1306	1966-67 4 door sedan	19.99 ea
	MB1307	1968 4 door sedan	19.99 ea
<i>Charger</i>	MB1308	1968-70 2 door sedan	19.99 ea
	MB1309	1971-74 2 door sedan	19.99 ea

B-Body Insulation Cont'd

<i>Coronet Hardtop</i>	MB1303	1965 2 door hardtop	19.99 ea
	MB1304	1966-67 2 door hardtop	19.99 ea
	MB1310	1968-70 2 door hardtop	19.99 ea
<i>Coronet Sedan</i>	MB1305	1964-65 2 door sedan	19.99 ea
	MB1305	1964-65 4 door sedan	19.99 ea
	MB1309	1971-74 4 door sedan	19.99 ea
<i>Daytona</i>	MB1312	1969 2 door sedan	19.99 ea
<i>Fury, Sport Fury Hardtop</i>	MB1313	1962 2 door hardtop	19.99 ea
	MB1302	1963 2 door hardtop	19.99 ea
	MB1301	1964 2 door hardtop	19.99 ea
	MB1305	1964 4 door hardtop	19.99 ea
<i>Fury Sedan</i>	MB1305	1964 2 door sedan	19.99 ea
	MB1305	1964 4 door sedan	19.99 ea
<i>GTx</i>	MB1304	1967 2 door sedan	19.99 ea
	MB1310	1968-70 2 door sedan	19.99 ea
	MB1309	1971-74 2 door sedan	19.99 ea
<i>Polara, Polara 500 Hardtop</i>	MB1315	1963 2 door hardtop	19.99 ea
	MB1301	1964 2 door hardtop	19.99 ea
	MB1305	1964 4 door hardtop	19.99 ea
<i>Polara Sedan</i>	MB1300	1963 2 door sedan	19.99 ea
	MB1305	1964 4 door sedan	19.99 ea
<i>Road Runner</i>	MB1310	1968-70 2 door sedan	19.99 ea
	MB1309	1971-74 2 door sedan	19.99 ea
	MB1316	1975 2 door sedan	19.99 ea
<i>Satellite Hardtop</i>	MB1303	1965 2 door hardtop	19.99 ea
	MB1304	1966-67 2 door hardtop	19.99 ea
	MB1310	1968-70 2 door hardtop	19.99 ea
<i>Satellite Sedan</i>	MB1307	1968 4 door sedan	19.99 ea
<i>Savoy Sedan</i>	MB1317	1964 2 door sedan	19.99 ea
<i>Superbird</i>	MB1318	1970 2 door sedan	19.99 ea

E-Body

<i>Barracuda</i>	ME1010	1970-74 2 door coupe	19.99 ea
<i>Challenger</i>	ME1011	1970-74 2 door coupe	19.99 ea

A-Body Divider Board

<i>Barracuda</i>	MA850	1967-69 notchback coupe	24.99 ea
<i>Dart</i>	MA767	1963-66 2 door sedan	24.99 ea
	MA768	1967-68 2 door sedan	24.99 ea
	ME1496	1967-69 2 door hardtop	24.99 ea
	MA770	1970-76 2 door hardtop	24.99 ea
<i>Dart Sport, Demon, Duster</i>	MA771	1970-76 2 door coupe	24.99 ea
<i>Lancer</i>	MA762	1960-62 2 door coupe	24.99 ea
<i>Scamp</i>	MA770	1970-76 2 door coupe	24.99 ea
<i>Valiant</i>	MA762	1960-62 2 door sedan	24.99 ea
	MA763	1963-66 2 door sedan	24.99 ea
	MA764	1967-69 2 or 4 door sedan	24.99 ea

B-Body Divider Board

MB569	1963-65	2 door hardtop	24.99 ea
MB570	1966-67	2 door hardtop	24.99 ea
MB571	1968-70	2 door hardtop	24.99 ea
MB572	1971-74	2 door hardtop	24.99 ea

E-Body Dividers

ME1496	1970-74	2 door coupe	24.99 ea
--------	---------	--------------	----------



MB575



A-Body Jute Insulation

<i>Barracuda</i>	MA774	1967-69 notchback coupe	14.99 ea
<i>Dart</i>	MA776	1963-66 2 door hardtop	14.99 ea
	MA774	1967-69 2 door hardtop	14.99 ea
	MA778	1970-76 2 door hardtop	14.99 ea
<i>Dart Sport, Demon, Duster</i>	MA779	1970-76 2 door coupe	14.99 ea
<i>Scamp</i>	MA778	1970-76 2 door hardtop	14.99 ea
<i>Valiant</i>	MA772	1963-66 2 door sedan	14.99 ea
	MA773	1967-69 2 or 4 door sedan	14.99 ea

B-Body

MB573	1963-65	2 door hardtop	14.99 ea
MB574	1966-67	2 door hardtop	14.99 ea
MB575	1968-70	2 door hardtop	14.99 ea
MB576	1971-74	2 door hardtop	14.99 ea

E-Body

MA774	1970-74	2 door coupe	14.99 ea
-------	---------	--------------	----------

Reproduction Dash Pads

New!



1964 Plymouth Dash Pad

MB2674510

Reproduction dash pad for 1964 Plymouth models including Belvedere, Fury and Sport Fury. Wrapped in vinyl and designed to replicate the original in every detail.
 MB2674100 1964 black \$95.99 ea
 MB2674510 1964 red \$95.99 ea

New!



MA1095338



MB2006100



MB1781100

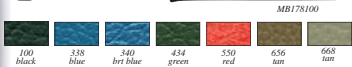

100 black 338 blue 340 bri blue 434 green 550 red 656 tan 668 tan

1968-74 A & B-Body OE Style Replacement Dash Pads

Replace your cracked or deteriorated original dash pad with a quality Replacement dash pad from Classic Industries®. Unlike urethane pads, these dash pads are vinyl over a metal core (except where noted), just like the original. An excellent replacement at an economical price. Specify color when ordering.

Note: Shipped oversize.

		A-Body	
1968 A-Body			
MA4727100	1968	black	299.99 ea
MA4727338	1968	blue	324.99 ea
MA4727550	1968	red	324.99 ea
MA4727656	1968	tan	324.99 ea
1969-74 A-Body			
MA1094100	1969-76	black	299.99 ea
MA1095338	1969-76	blue	324.99 ea
MA1095434	1969-76	green	324.99 ea
MA1095550	1969-76	red	324.99 ea
MA1095656	1969-76	tan	324.99 ea

		B-Body	
1966-67 B-Body (Except Charger)			
MB2008100	1966-67	black	279.99 ea
MB2009338	1966-67	blue	304.99 ea
MB2009656	1966-67	tan	304.99 ea
1966-67 Charger			
MB2006100	1966-67	black	279.99 ea
MB2007338	1966-67	blue	304.99 ea
MB2007550	1966-67	red	304.99 ea
1968 B-Body			
MB531100	1968	black	279.99 ea
MB53238	1968	blue	304.99 ea
MB53244	1968	green	304.99 ea
MB532656	1968	tan	304.99 ea

1969-70 B-Body			
MB529100	1969-70	black	279.99 ea
MB53038	1969-70	blue	304.99 ea
MB53044	1969-70	green	304.99 ea
MB53050	1969-70	red	304.99 ea
MB530650	1969	saddle	304.99 ea
MB530656	1970	brown	304.99 ea
1971-74 B-Body w/Steel Core			
MB178100	1971-74	black	459.99 ea
MB178340	1971-74	bright blue	459.99 ea
MB178668	1971-74	tan	459.99 ea
1971-74 B-Body w/ABS Core			
MP179100	1971-74	black	389.99 ea
MP179340	1971-74	bright blue	389.99 ea
MP179668	1971-74	tan	389.99 ea

New!

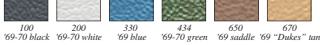

100 200 330 434 650 670
 '69-70 black '69-70 white '69 blue '69-70 green '69 saddle '69 "Dukes" tan



1969-70 B-Body Reproduction Dash Pads



Original-style reproduction dash pads from Legendary Auto Interiors. Each reproduction dash pad is manufactured on a stamped steel core and wrapped with vinyl materials featuring the factory-correct grain and coloration. Each dash pad features correct contours, dimensions, and correct length mounting studs for an unparalleled fit and finish. Choose from a selection of original colors. Made in USA.

Note: Please specify color when ordering. No further discounts apply.



MB285 1969-70 464.99 pr



MES510100



100 black 200 white 340 bri blue 434 dk green 526 maroon 540 burnt orng 550 red 650 saddle

1970-74 E-Body OE Style Replacement Dash Pads

Each dash pad is wrapped in vinyl and manufactured on an ABS frame to reinforce the weak spots of the original dash. These dash pads feature correctly located mounting studs for a proper fit and are available for cars with or without air conditioning, 1 or 3 speaker holes, and in all factory colors. Made in USA.

Note: Only 1970 Barracuda and Challenger dash pads include the pre-installed name plate. Please add 3 digit color code when ordering. Shipped oversize.

1970-74 Barracuda Models

1 Speaker without AC		081	
MES510100	1970	black	499.99 ea
MES511	1970	factory colors	589.99 ea
MES526100	1971-74	black	499.99 ea
MES527	1971-74	factory colors	589.99 ea
3 Speaker without AC			
MES512100	1970	black	499.99 ea
MES513	1970	factory colors	589.99 ea
MES528100	1971-74	black	499.99 ea
MES529	1971-74	factory colors	589.99 ea
1 Speaker with AC			
MES514100	1970	black	499.99 ea
MES515	1970	factory colors	589.99 ea
MES530100	1971-74	black	499.99 ea
MES531	1971-74	factory colors	589.99 ea
3 Speaker with AC			
MES516100	1970	black	499.99 ea
MES517	1970	factory colors	589.99 ea
MES532100	1971-74	black	499.99 ea
MES533	1971-74	factory colors	589.99 ea

1970-74 Challenger Models

1 Speaker without AC		081	
MES518100	1970	black	549.99 ea
MES519	1970	factory colors	639.99 ea
MES526100	1971-74	black	499.99 ea
MES527	1971-74	factory colors	589.99 ea
3 Speaker without AC			
MES520100	1970	black	549.99 ea
MES521	1970	factory colors	639.99 ea
MES528100	1971-74	black	499.99 ea
MES529	1971-74	factory colors	589.99 ea
1 Speaker with AC			
MES52100	1970	black	549.99 ea
MES523	1970	factory colors	639.99 ea
MES530100	1971-74	black	499.99 ea
MES531	1971-74	factory colors	589.99 ea
3 Speaker with AC			
MES524100	1970	black	549.99 ea
MES525	1970	factory colors	639.99 ea
MES532100	1971-74	black	499.99 ea
MES533	1971-74	factory colors	589.99 ea

B DASH & CONSOLE COMPONENTS

Dash Pad Covers

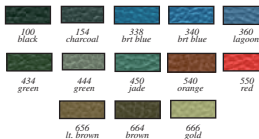

MA1089100



MB526540



MB527100

1963-76 Dash Pad Covers

Conceal unsightly cracks or discolored areas of your dash pad with an ABS plastic dash pad cover as an easy and economical alternative to replacing the entire dash pad. Vacuum-molded from thick, durable ABS material, these dash pad covers will not crack when exposed to extreme hot or cold temperatures like the original vinyl-

skinned dash pads. Each dash cover will easily install right over your existing original dash without using any special tools. E-Body dash covers will cover the nameplate on the RH side of the original dash. Specify color when ordering. Made in the USA. *Note: Shipped oversize.*



1963-76 A-Body

1963-64 Dart, Valiant			
MA1088100	1963-64	black	64.99 ea ⁽⁸⁸⁾
1965-68 Barracuda, Dart, Valiant			
MA1089100	1965-66	black	64.99 ea
MA1090100	1967	black	64.99 ea
MA1091100	1968	black	64.99 ea
1969 A-Body			
MA1092100	1969	black	64.99 ea
MA1093154	1969	charcoal	94.99 ea
MA1093340	1969	bright blue	94.99 ea
MA1093434	1969	dark green	94.99 ea
MA1093550	1969	red	94.99 ea
MA1093656	1969	light brown	94.99 ea
1970-76 A-Body			
MA1092100	1969	black	64.99 ea
MA1093154	1970	charcoal	94.99 ea
MA1093340	1972-73	bright blue	94.99 ea
MA1093660	1974-76	lagoon blue	94.99 ea
MA1093434	1970-71	dark green	94.99 ea
MA1093444	1972-73	green	94.99 ea
MA1093450	1974-76	jade green	94.99 ea
MA1093550	1970	red	94.99 ea
MA1093656	1970-71	light brown	94.99 ea
MA1093666	1971-72	gold	94.99 ea

1966-74 B-Body

1966-67 B-Body (except Charger)			
MB523100	1966-67	black	69.99 ea ⁽⁸⁸⁾
1968 B-Body All Models			
MB524100	1968	black	69.99 ea
1969-70 B-Body			
MB525100	1969-70	black	74.99 ea
MB526154	1970	charcoal	109.99 ea
MB526338	1970	bright blue	109.99 ea
MB526434	1969-70	green	109.99 ea
MB526540	1970	orange	109.99 ea
MB526656	1970	tan	109.99 ea
MB526664	1970	brown	109.99 ea
1971-74 B-Body			
MB527100	1971-74	black	99.99 ea
MB528340	1971-73	bright blue	109.99 ea
MB528360	1974	lagoon blue	109.99 ea
MB528434	1971	dark green	109.99 ea
MB528444	1972-73	green	109.99 ea
MB528450	1974	jade green	109.99 ea
MB528664	1971	brown	109.99 ea
MB528666	1971-72	gold	109.99 ea

1970-74 E-Body

1970 Barracuda, 1 speaker *Cuda with AC			
ME1457100	1970	black	99.99 ea ⁽⁸⁸⁾
ME1458154	1970	charcoal	129.99 ea
ME1458338	1970	bright blue	129.99 ea
ME1458434	1970	dark green	129.99 ea
ME1458540	1970	orange	129.99 ea
ME1458550	1970	red	129.99 ea
ME1458656	1970	brown	129.99 ea
1970 Barracuda, 1 speaker *Cuda without AC			
ME1459100	1970	black	99.99 ea
ME1460154	1970	charcoal	129.99 ea
ME1460338	1970	bright blue	129.99 ea
ME1460434	1970	dark green	129.99 ea
ME1460540	1970	orange	129.99 ea
ME1460550	1970	red	129.99 ea
ME1460656	1970	brown	129.99 ea
1970 Challenger 1 speaker with AC			
ME1465100	1970	black	99.99 ea
ME1466338	1970	bright blue	129.99 ea
ME1466434	1970	dark green	129.99 ea
ME1466540	1970	orange	129.99 ea
ME1466550	1970	red	129.99 ea
ME1466656	1970	brown	129.99 ea
1970 Challenger 1 speaker without AC			
ME1467100	1970	black	99.99 ea
ME1468338	1970	bright blue	129.99 ea
ME1468434	1970	dark green	129.99 ea
ME1468540	1970	orange	129.99 ea
ME1468550	1970	red	129.99 ea
ME1468656	1970	brown	129.99 ea
1971-74 E-Body, 1 speaker with AC			
ME1461100	1971-74	black	99.99 ea
ME1462340	1971-73	blue	129.99 ea
ME1462360	1974	lagoon blue	129.99 ea
ME1462444	1972-73	green	129.99 ea
ME1462450	1974	jade green	129.99 ea
ME1462664	1971	brown	129.99 ea
ME1462666	1971-72	gold	129.99 ea
1971-74 E-Body, 1 speaker without AC			
ME1463100	1971-74	black	99.99 ea
ME1464340	1971-73	blue	129.99 ea
ME1464360	1974	lagoon blue	129.99 ea
ME1464444	1972-73	green	129.99 ea
ME1464450	1974	jade green	129.99 ea
ME1464664	1971	brown	129.99 ea
ME1464666	1971-72	gold	129.99 ea

Instrument Cluster

AUTHORIZED

AUTOMATIC RESTORATION



MA1528

MA1529

1964 Plymouth A-Body Instrument Bezels

Dash panel instrument bezels for 1964 Barracuda and Valiant models. Features correct lettering, silver face and chrome accents.

MA1528 1964 instrument cluster 199.99 ea
MA1529 1964 dash switches 64.99 ea

AUTHORIZED

AUTOMATIC RESTORATION



MA2479

1965 A-Body Instrument Bezels

Reproduction of the instrument bezels for 1965 Barracuda, Valiant and Dart models. Manufactured as original with the correct holes, color and texture for a correct fit and appearance.

MA2479 1965 Barracuda, Valiant 229.99 ea
2496389 1965 Dart 209.99 ea

AUTOMATIC RESTORATION



MA565



MA573

1967-69 Barracuda Dash Bezels

Replacement dash bezels for 1967-69 Barracuda. Also available is the silver glove box bezel that completes the dash face. Instrument bezels are available with your choice of black or woodgrain accent. Applications are available for models with or without factory AC.

Important: Glove box bezel is sold separately.

Instrument Bezels

1967 - Black & Silver	
MA565 1967 with AC.....	444.99 ea
MA566 1967 without AC.....	444.99 ea
1967 - Woodgrain & Silver	
MA567 1967 with AC.....	534.99 ea
MA568 1967 without AC.....	534.99 ea
1968-69 - Black & Silver	
MA569 1968-69 with AC.....	444.99 ea
MA570 1968-69 without AC.....	444.99 ea
1968-69 - Woodgrain & Silver	
MA571 1968-69 with AC.....	534.99 ea
MA572 1968-69 without AC.....	534.99 ea

Glove Box Bezel

Replacement glove box bezel for 1967-69 Barracuda models. This trim piece fits below the glove box door, it features correct style lettering and chrome edges just like the original.

MA573 1967-69 all 104.99 ea

AUTOMATIC RESTORATION



MA1527

1967-69 Dart Dash Bezel Sets

Replacement 1967-69 Dart dash bezels from Classic Industries®. Original dash bezels can be difficult to find and very expensive to refinish. Our new bezels are replacements of the original and feature the correct grain and chrome accents and include the glove box door. Available for models with or without AC.

Complete Dash Bezel Sets

With Glove Box Door Finish Plate	
MA1527 1967-69 without AC.....	494.99 set
MA1601 1967-69 with AC.....	494.99 set
Without Glove Box Door Finish Plate	
MA1781 1967-69 without AC.....	369.99 set
MA1782 1967-69 with AC.....	328.99 set

Individual Components

Gauge Bezel	
MA1783 1967-69	204.99 ea
Radio Bezel	
MA1784 1967-69 without AC.....	174.99 ea
MA1785 1967-69 with AC.....	174.99 ea
AC/Heater Bezel	
MA668003 1967-69 bezel w/o AC.....	164.99 ea
MA668004 1967-69 bezel w/AC.....	164.99 ea
Heater Delete Plate	
MA1786 1967-69	174.99 ea
Glove Box Door Finish Plate	
MA1787 1967-69	154.99 ea

AUTOMATIC RESTORATION



MA582

1970-71 A-Body Rallye Dash Bezels

Replacement Rallye dash bezels for 1970-71 A-Body. Also available is the black & chrome glove box bezel that completes the dash face. Applications for Rallye gauge equipped A-Body vehicles such as 1970 Dart Swinger 340, 1970-71 Duster 340 and 1971 Demon 340.

*Note: *No further discounts apply.*

Instrument Bezels

1970 Models With Thumb Wheel Radio	
MA576 1970 with AC, with glove box bezel.....	494.99 ea
MA577 1970 w/o AC, with glove box bezel.....	494.99 ea
1971 Models With Round Knob Radio	
MA580* 1971 with AC.....	444.99 ea
MA581* 1971 w/o AC.....	444.99 ea

Glove Box Bezel

Glove box bezel for 1970-71 A-Body models. This trim piece fits below the glove box door, it features correct black insert and chrome edges just like the original. Fits Demon, Dart Sport and Duster models.

MA582 1970-71 all 104.99 ea

B DASH & CONSOLE COMPONENTS

Instrument Cluster

New!



MB15101

1965 Belvedere Dash Bezel Components

Reproduction dash bezel components for 1965 Belvedere models. The bezel set is manufactured in injection molded plastic with the correct details and includes the cluster and gear selector bezels. The dash lens is manufactured to original specifications.

MB15101	1965	dash bezel set	344.99	set
MB15102	1965	dash lens	184.99	set



MB498



MB999

1966-67 B-Body Dash Gauge Bezel

Dash gauge housing unit for 1966-67 B-Body models. This injection-molded replacement is produced to original specifications. Features correct black face and chrome accents to give it a factory appearance. Also available is the black & chrome glove box trim that completes the dash face.

Instrument Bezels

1966-67 Models With AC				
MB4974	1966-67	Charger	344.99	ea
MB499	1966-67	Coronet	344.99	ea
MB999	1967	GTJ/Satellite	344.99	ea
1966-67 Models Without AC				
MB496	1966-67	Charger	344.99	ea
MB498	1966-67	Coronet	344.99	ea
MB999	1967	GTJ/Satellite	344.99	ea

Glove Box Door

Replacement glove box door for 1966-67 B-Body models. Features correct face pattern and the chrome outer edge.

MB495	1966-67	Charger/Coronet	184.99	ea
MB1777	1967	GTJ/Satellite	174.99	ea

New!



MB883

1968 B-Body Rallye Dash Bezel Set

Rallye dash bezel set for 1968 B-Body models. Applications for Rallye dash equipped Charger, Coronet and Super Bee.

3 Piece Set - Factory AC

Our 3 piece sets for vehicles equipped with factory AC include gauge bezel, radio bezel and upper passenger side dash bezel.

MB885	1968	AM radio/8 track	394.99	set
MB886	1968	standard radio	394.99	set

5 Piece Set - without AC

Our 5 piece sets for vehicles without factory AC include gauge bezel, radio bezel, upper passenger side dash bezel and LH and RH vent delete bezels.

MB882	1968	AM radio/8 track	494.99	set
MB883	1968	standard radio	494.99	set

Dash Switch Plates

MB1477	1968	defroster switch trim plate	49.99	ea
MB1478	1968	defroster delete plate	49.99	ea
MB1479	1968	convertible switch trim plate	134.99	ea



MB864

1969-70 B-Body Rallye Dash Bezel Sets

Our new bezels replicate the original in every detail and are the simple solution to your cracked or worn original. Applications for Rallye dash equipped B-Body vehicles such as 1969-70 Charger, Coronet, Super Bee and 1970 GTX, Road Runner, Sport Satellite. Sets for non air conditioned cars include vent delete bezels.

With Air Conditioning - 3 piece set

MB863	1969	AM radio/8 track	394.99	set
MB864	1969	standard radio	394.99	set
MB868	1970	AM radio/8 track	394.99	set
MB869	1970	standard radio	394.99	set

Without Air Conditioning - 5 piece set

MB853	1969	AM radio/8 track	494.99	set
MB854	1969	standard radio	494.99	set
MB858	1970	AM radio/8 track	494.99	set
MB859	1970	standard radio	494.99	set



MB870

1969-70 B-Body Woodgrain Rallye Dash Sets

Our new woodgrain fascias replicate the original in every detail and are the simple solution to your damaged or faded original. Applications for Rallye dash equipped B-Body vehicles such as 1969-70 Charger, Coronet, Super Bee and 1970 GTX, Road Runner, Sport Satellite. Sets for non air conditioned cars include vent delete bezels.

With Air Conditioning (3 piece set)

MB865	1969	standard radio	599.99	set
MB866	1969	AM radio/8 track	599.99	set
MB870	1970	standard radio	599.99	set
MB871	1970	AM radio/8 track	599.99	set

Without Air Conditioning (5 piece set)

MB855	1969	standard radio	699.99	set
MB856	1969	AM radio/8 track	699.99	set
MB860	1970	standard radio	699.99	set
MB861	1970	AM radio/8 track	699.99	set

New!



MB17903

MB17904

MB17905

1968-70 B-Body Lower Dash Trim

Reproduction lower dash trim panel components for 1968-70 Mopar B-Body models. 1968-69 Charger trim pieces are made with vinyl-wrapped foam over a steel core, as original. 1970 B-Body trim pieces are manufactured in black, injection molded plastic, as original. Paint as required.

1969-69 Charger

MB17981	1968-69	left side dash trim	94.99	ea
MB17982	1968-69	center dash with AC	194.99	ea
MB17983	1968-69	center dash without AC	194.99	ea
MB17984	1968-69	glove box door	194.99	ea

1970 B-Body w/Rallye Dash

MB17903	1970	left side dash trim	89.99	ea
MB17904	1970	center dash without AC	114.99	ea
MB17905	1970	glove box door	114.99	ea
MB17906	1970	3-piece set	294.99	set



1968-70 B-Body Lower Dash Panel Trim

Reproduction of the lower dash panel trim pieces for 1968-70 B-Body models. Manufactured in black with chrome edge, these are available in the correct ribbed or pebble grain texture.

MB1688	1968	ribbed	29.99	pr
MB1689	1969-70	pebble grain	29.99	pr



MB1688

Instrument Cluster



MA552



MB823

1968-76 Woodgrain Dash Panel Insert Sets

Chipped, worn or discolored original woodgrain panels can ruin an otherwise nice die restoration. These die-cut replacement inserts are manufactured from a pressure sensitive vinyl material in the closest grain and color available. Made in the USA.

A-Body

1968-76 A-Body - Instrument Inserts

Note: *1968 Barracuda originally had a Barwood grain insert which is not currently available. The 1969 Barracuda insert will fit, but it is not a Barwood grain.

1968-69 Barracuda

MA549* 1968-69 3 piece upper set 34.99 set

1970-76 A-Body

MA550 1970-76 without warning lights 34.99 ea

MA551 1970-76 with seat belt warning light 34.99 ea

MA552 1970-76 with seat belt, light, wiper indicator 44.99 ea

MA553 1970-76 with EGR, brake lights 34.99 ea

1970-71 Duster 340, 1971 Demon 340 w/Rally Gauges

MA554 1970-71 3 piece upper set 34.99 set

Lower Dash Panel Woodgrain Inserts

1968-69 Barracuda

MA557 1968-69 lower dash panel 44.99 ea

1970-71 Duster 340, 1971 Demon 340

MA557 1970-71 for Rallye gauges 44.99 ea

Radio Panel Woodgrain Inserts

1972-76 A-Body

MA555 1972-76 with AC 34.99 ea

MA556 1972-76 without AC 34.99 ea

Glove Box Inserts

1968-69 Barracuda

MA559 1968-69 with Barracuda insert 24.99 ea

1970-71 Duster 340, 1971 Demon 340

MA560 1970-71 lower glove box panel 24.99 ea

1972-76 A-Body

MA561 1972-76 glove box panel 44.99 ea

B-Body

1969-70 - Complete Set with Lettering

Note: These sets feature lettering for switch functions such as lights, panel, wiper, washer, etc.

1969 with AC

MB819 1969 standard radio, 4 piece 89.99 set

MB820 1969 AM radio/8 track, 4 piece 89.99 set

1969 w/o AC

MB821 1969 standard radio, 6 piece 94.99 set

MB822 1969 AM radio/8 track, 6 piece 94.99 set

1970 with AC

MB823 1970 standard radio, 4 piece 89.99 set

MB824 1970 Coronet radio, 3 piece 89.99 set

MB825 1970 AM radio/8 track, 4 piece 89.99 set

1970 w/o AC

MB826 1970 standard radio, 6 piece 94.99 set

MB827 1970 Coronet radio, 5 piece 94.99 set

MB828 1970 am radio/8 track, 6 piece 94.99 set

1969-70 - Complete Set w/o Lettering

Note: These sets do not have the lettering to identify the switch functions.

1969 with AC

MB829 1969 standard radio, 4 piece 69.99 set

MB830 1969 am radio/8 track, 4 piece 69.99 set

1969 w/o AC

MB831 1969 standard radio, 6 piece 74.99 set

MB832 1969 am radio/8 track, 6 piece 74.99 set

1970 with AC

MB833 1970 standard radio, 4 piece 69.99 set

MB834 1970 Coronet radio, 3 piece 69.99 set

MB835 1970 am radio/8 track, 4 piece 69.99 set

B-Body Cont'd

1970 w/o AC

MB836 1970 standard radio, 6 piece 74.99 set

MB837 1970 Coronet radio, 5 piece 74.99 set

MB838 1970 AM radio/8 track, 6 piece 74.99 set

1969-70 Individual Components

Instrument Bezel Insert

MB815 1969 without lettering 49.99 ea

MB816 1969 with lettering 49.99 ea

MB817 1970 without lettering 49.99 ea

MB818 1970 with lettering 49.99 ea

Radio Bezel Insert

MB839 1969 standard radio 19.99 ea

MB840 1969-70 AM radio/8 track 19.99 ea

MB841 1970 standard radio 19.99 ea

MB842 1970 Coronet radio 19.99 ea

Passenger Side Dash Panel Insert

MB843 1969-70 above glove box door 19.99 ea

Side Panel Vent Delete Inserts

MB844 1969-70 LH and RH 14.99 ea

E-Body

1970-71 Barracuda, 'Cuda

ME1469 1970 Gran Coupe dash 39.99 ea

ME1470 1970-71 Rallye dash, 3 switch 39.99 ea

ME1471 1970-71 Rallye dash, 4 switch 39.99 ea

1970-71 Challenger

ME1472 1970 Challenger SE dash 39.99 ea

ME1470 1970-71 Rallye dash, 3 switch 39.99 ea

ME1471 1970-71 Rallye dash, 4 switch 39.99 ea

1972-74 Barracuda, 'Cuda, Challenger

ME1475 1972-74 Rallye dash 3 switch 39.99 ea

ME1476 1972-74 Rallye dash 4 switch 39.99 ea



ME1485

1970-74 E-Body Rallye Dash Bezel Kit

Replace the Rally Gauge face and switch plate in your 1970-74 E-Body with brand new dash bezels from Classic Industries®. The woodgrain finish on these aluminum bezels is screened on just like the originals. Stamped from a flat aluminum panel, minor bending of panel is necessary before installation to get proper curvature in corners. Available for 1970-74 Rallye dash equipped E-Body vehicles.

3 Switch Panel

ME1483 1970-71 hardtop 184.99 set

ME1486 1972-74 hardtop 184.99 set

4 Switch Panel

ME1485 1970-71 convertible, top lift 204.99 ea

ME1484 1970-71 hardtop, defog 184.99 ea

ME1487 1972-74 hardtop, defog 184.99 ea



ME861001

ME861002

1970-74 E-Body Lower Dash Trim

Reproduction lower dash molding for 1970-74 Barracuda and Challenger models. Manufactured in injection molded ABS plastic with correct Coachman grain, as original. Available in black or can be painted with OER® Interior Paints to match your interior.

ME861001 1970-74 LH - except 1970 Challenger 74.99 ea

ME861002 1970-74 RH - except 1970 Challenger 74.99 ea

ME861003 1970 LH - Challenger only 114.99 ea

ME861004 1970 RH - Challenger only 114.99 ea

E DASH & CONSOLE COMPONENTS

Instrument Cluster



1967-71 A-Body Rallye Dash Gauge Parts

1967-71 A-Body Rallye dash cluster parts from Classic Industries®. Replace original indicator lenses, dash reset knobs, and gauge lenses. Original outer lenses that are scratched, cloudy, yellowed or covered in overspray can be very difficult to see through and even more difficult to repair. Applications are available for 1967-69 Barracuda and Rallye dash equipped vehicles such as 1970 Dart Swinger 340, 1970-71 Duster 340 and 1971 Demon 340.

Note: Original lenses were accented with satin black in the chrome center. These have a chrome center, but black accent can be painted on for a more original look.

- MA562 1967-71 gauge lenses 214.99 set
- MA564 1967-71 indicator lenses..... 41.99 set
- MA563 1967-71 dash reset knob..... 19.99 ea



1967-69 Dart Dash Gauge Lens

Dash gauge lens for 1967-69 Dart models. This lens is manufactured to factory specifications. Will fit and install in original or reproduction dash cases.

- MA1526 1967-69 dash gauge lens 114.99 ea



1966-67 Charger Gauge Cluster Lenses

Dash gauge and indicator lenses for 1966-67 Charger models. Lenses feature the correct style lettering and font. Gauge lenses include chrome accents.

- MB1229 1966-67 gauge lenses..... 184.99 set
- MB15103 1966-67 indicator lenses..... 41.99 set



MB1230



MB1231

1966-67 B-Body Dash Gauge Lens

Renew the look of your instrument panel with a new lens from Classic Industries®. This lens is manufactured to factory specifications. Will fit and install in original or reproduction dash cases.

- MB1230 1966-67 Coronet..... 184.99 ea
- MB1231 1967 GTX/Satellite..... 184.99 ea



MB846



MB845



MB849

1968-70 B-Body Standard Dash Gauge Parts

Replace the instrumentation in your 1968-70 B-Body with brand new dash gauge parts from Classic Industries®. New outer chrome bezels and indicator light lenses are also available. Applications are available for 1968-70 B-Body vehicles with standard non-Rallye gauges.

- 1968-70 Chrome Bezel**
- MB845 all w/standard gauges 204.99 ea
- 1968-69 Outer Lens**
- MB846 120 mph speedo 184.99 ea
- MB847 150 mph speedo (marked 0-150). 204.99 ea
- MB848 150 mph speedo (marked 0-15). 204.99 ea
- 1968-70 Indicator Light Lens Set with Gaskets**
- MB849 all w/standard gauges 41.99 set



1968-70 B-Body Rallye Gauge Lens

Replacement Rallye gauge lenses for 1968-70 B-Body models. Original lenses that are scratched, cloudy, yellowed or covered in overspray can be very difficult to see through and even more difficult to repair. For 1968-70 B-Body vehicles with Rallye gauges including 1968-70 Charger, Coronet, Super Bee and 1970 GTX, Road Runner and Satellite.

- MB850 1968-70 gauge lens..... 204.99 ea

New!



OER

1970-74 E-Body Standard Dash Lens

Reproduction of the original instrument panel lens for 1970-74 E-Body models equipped with standard gauges. This reproduction is made from crystal clear high quality injection molded material. Each lens is manufactured to Mopar specs and features correct markings and Pentastar logo. Each lens also features the correct black paint accenting on lower half of the speedometer area.

- 2984110 1970-74 189.99 ea

New!



OER

1970-74 E-Body Indicator Lamp Lenses

OER® reproduction of the green lens covers that install on the inside of the 1970-74 standard gauge cluster housing. Sold as a pair.

- ME7074 1970-74 E-Body 29.99 pr

New!

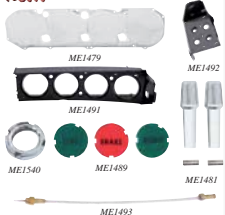

1970-74 E-Body Rallye Gauge Cluster Parts

Renew the instrumentation in your 1970-74 E-Body with brand new gauge cluster components from Classic Industries®. We offer new lenses that are replacements of the original and include the correct light tubes. New housings, gauge indicator lenses and gauge reset parts are also available. Applications are available for 1970-74 Rallye gauge equipped E-Body vehicles.

Note: Identification of gauge cluster is important. On 1970-71 models, the dash reset knobs protrude through the outer bezel of the gauge. On the 1972-74 models, the reset knobs protrude directly out of the gauge face through the clear plastic lens.

- Outer Lens**
- ME1479 1970-71 w/o reset knob holes. 204.99 ea
- ME1480 1972-74 w/reset knob holes. 204.99 ea

- Housings**
- ME1491 1970-74 gauge housing..... 257.99 ea
- ME1492 1970-74 switch housing..... 184.99 ea

- Indicator Lens Set, Marked Left, Brake, Right**
- ME1489 1970-74 3 piece set..... 41.99 set

- Indicator Lens Tubes**
- ME17539 1970-74 3 piece set..... 41.99 set

- Reset Knobs w/Screw**
- ME1481 1970-71 short style..... 51.99 pr
- ME1482 1972-74 long style..... 51.99 pr

- Cables & Nut**
- ME1540 1970-71 nut only..... 19.99 ea
- ME1493 1970-71 reset cable w/o nut. 72.99 ea

In-Dash Gauges

New!



MB2001B

1964-74 Gauge Cluster Limiters

Voltage limiter designed to provide a constant 5-volt supply and circuit protection up to 18-volts. This limiter will work with factory or replacement gauges and is required when using replacement gauges in order for them to function properly.

Note: Choose A for good quality or B for better quality.
 MB2000A 1967-71 A-Body 44.99 ea
 MB2000B 1966-70 B-Body 69.99 ea
 MB2001A 1971-74 B-Body 44.99 ea
 MB2001B 1970-74 E-Body 69.99 ea



3592360

OER

1967-76 Speedometer Cables

Replacement speedometer cables for 1967-76 Dodge and Plymouth A, B, and E-Body models. Includes original style rubber grommets for installation.

OER® Cables
 2822713 1967 59.99 ea
 3592360 1968-76 62" 44.99 ea

New!



MP14029

1966-76 Speedometer Gears

New OEM speedometer gears for all 1966-76 A, B, and E-Body models. Fits automatic and manual transmissions.

MP14026 1966-76	26 teeth - red	59.99 ea
MP14028 1966-76	28 teeth - blue	59.99 ea
MP14029 1966-76	29 teeth - black	59.99 ea
MP14030 1966-76	30 teeth - yellow	59.99 ea
MP14031 1966-76	31 teeth - green	59.99 ea
MP14032 1966-76	32 teeth - black	59.99 ea
MP14033 1966-76	33 teeth - yellow	59.99 ea
MP14034 1966-76	34 teeth - green	59.99 ea
MP14035 1966-76	35 teeth - orange	59.99 ea
MP14036 1966-76	36 teeth - red	59.99 ea
MP14037 1966-76	37 teeth - white	59.99 ea
MP14038 1966-76	38 teeth - blue	59.99 ea
MP14039 1966-76	39 teeth - green	59.99 ea
MP14040 1966-76	40 teeth - orange	59.99 ea
MP14041 1966-76	41 teeth - red	59.99 ea
MP14042 1966-76	42 teeth - white	59.99 ea
MP14043 1966-76	43 teeth - blue	59.99 ea



1966-70 B-Body Speedo Cable Bracket

This bracket holds the speedometer cable and brake line to the left inner fender well on 1966-1970 B-Body vehicles. Manufactured from stainless steel with a zinc finish for longevity. Correct mounting screw is included.
 MB1728 1966-70 B-Body 9.99 ea

New!



MA1546

OER AUTHENTIC RESTORATION



2984403



2984404



2984405



MA1547



3592194



3592195



3592196

1967-76 A-Body Gauges

Replacement gauges for 1967-76 Dodge and Plymouth A-Body models. These gauges feature white lettering/numbering with orange pointer needles. Will fit properly and function correctly with your original sending units and temperature sensor. Manufactured as original to exact specifications including correct lettering and fonts.

Dart, Dart Swinger, Scamp

Note: *These are replacement gauges that require a solid state limiter.

MA1546*	1967-71 fuel gauge	94.99 ea
MA1547*	1967-71 temp gauge	94.99 ea

Demon, Duster, Valiant

2984403	1970-71 fuel gauge	129.99 ea
2984404	1970-71 temp gauge	129.99 ea
2984405	1970-71 amp gauge	119.99 ea

Demon, Dart Sport, Duster, Valiant

3592194	1972-76 fuel gauge	129.99 ea
3592195	1972-76 temp gauge	129.99 ea
3592196	1972-76 amp gauge	139.99 ea

New!



MA679

OER AUTHENTIC RESTORATION



MA678

1967-76 A-Body Oil/Brake Light Housing

Replacement oil/brake light housing for 1967-76 Mopar A-Body vehicles. Fits and functions just like the original and includes the red lens and the cluster housing to light housing gasket. Officially licensed Mopar Authentic Restoration Product.
 MA679 1967-73 A-Body 29.99 ea
 MA678 1972-76 29.99 ea

New!



3837352

1970-76 A-Body Speedometer

Replacement 120 MPH speedometers for 1970 Plymouth A-Body models including Valiant, Duster and Scamp, and 1972-76 Dodge & Plymouth A-Body vehicles. Manufactured with the correct font and authentic colored needle. Includes the turn signal and high beam tubes and lenses. Officially licensed Mopar Authentic Restoration Product.

Note: *This 120 MPH speedometer is correct for 1972-74 but will fit and function in 1975-76 models. 1975-76 models need a 100 MPH speedometer.

2984960	1970 Plymouth	299.99 ea
3837352*	1972-76 Dodge & Plymouth	249.99 ea



MA1525

1967-71 A-Body Rallye Tachometers

Replacement tachometers that feature the authentic appearance of original Rallye tachs, but are internally updated with modern electronic technology. This allows them to work with many different types of ignition systems including breaker point ignition, electronic ignition and even MSD or Pertronix ignition systems. Applications are available for 1967-71 A-Body vehicles equipped with Rallye dash.
 MA1524 1967-71 008 o'clock position 204.99 ea
 MA1525 1967-71 005 o'clock position 204.99 ea

OER AUTHENTIC RESTORATION



1967-71 A-Body Rallye Gauge Set

Rallye gauge set for 1967-71 Dart and 1970-71 Dart Swinger models equipped with the Rallye instrument package. This complete set includes a temperature, gasoline, alternator and an oil pressure gauge, along with a solid state limiter.
 MA1548 1967-71 set of 4 gauges 429.99 ea

In-Dash Gauges

1964 B-Body Tachometer

This retro-look in-dash tachometer bolts into the blank panel on the far right of the instrument panel where the block-off plate or optional clock would normally go. This tachometer is manufactured to work with many different types of ignition systems including breaker point ignition, electronic ignition and even MSD or Pertronix ignition systems.

MB324 1964 Plymouth tach..... 204.99 ea
MB492 1964 Dodge tach..... 179.99 ea



MB324



MB494



MB321



MB491

1966-74 B-Body Standard Tachometer

Replacement tachometer that features an authentic appearance, but is internally updated with modern electronic technology. This allows it to work with many different types of ignition systems including breaker point ignition, electronic ignition, even MSD or Pertronix ignition systems.

Note: For standard rectangular style gauge equipped 1966-70 B-Body vehicles with 57 or NBS tachometer option.

MB494 1966-67 Coronet tach..... 179.99 ea
MB321* 1968-70 B-Body tach..... 204.99 ea
MB491 1971-74 B-Body tach..... 204.99 ea



MB320

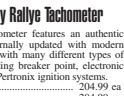

MB323

1968-74 B-Body Rally Tachometer

This replacement tachometer features an authentic appearance but is internally updated with modern electronics. Will work with many different types of ignition systems including breaker point, electronic ignition, even MSD or Pertronix ignition systems.

MB320 1968-70 B-Body tach..... 204.99 ea
MB323 1971-74 B-Body tach..... 204.99 ea

1966-67 Coronet Gauges

Gauges can be difficult to find and very expensive to repair or refinish. With our OE quality replacement gauges, you can eliminate those hassles completely.

Note: These gauges require a solid state limiter, or an updated circuit board.

MB2042 1966-67 fuel gauge..... 94.99 ea
MB2010 1966-67 temperature gauge..... 94.99 ea
MB2011 1966-67 ammeter gauge..... 94.99 ea



MB2011



MB1724



MB2048

1966-70 B-Body Gauges

Replacement gauges for 1966-70 B-Body models. New dash gauges are the bolt-in solution to a missing or inoperative original gauge. Available for standard dash-equipped 1966-70 B-Body vehicles.

Note: These gauges require a solid state limiter.

Temperature Gauge

MB1724 1966-67 Belvedere, Satellite..... 94.99 ea
MB1724 1967 GTX..... 94.99 ea
MB2047 1968-70 B-Body..... 94.99 ea

Fuel Gauge

MB1725 1966-67 Belvedere, Satellite..... 94.99 ea
MB1725 1966-67 GTX..... 94.99 ea
MB2029 1968-70 B-Body..... 94.99 ea

Ammeter Gauge

MB2048 1968-70 B-Body..... 94.99 ea

Updated Circuit Board

MB2013 1968-70 non-Rallye..... 149.99 ea

1968-74 B-Body Tach Wiring Harness

This tachometer wiring harness is a bolt-in replacement of the originals and are the solution to your missing or hacked up original tachometer wiring. Available for 1968-74 B-Body models.

MB373 1968-70..... 39.99 ea
MB322 1971-74..... 39.99 ea



MB373

1970-74 E-Body Speedometer

OER® reproduction 120 MPH speedometer found on all 1970-74 E-Body models with standard gauges. Manufactured to exact specifications featuring correct color, lettering and fonts.

Officially licensed Mopar Authentic Restoration Product.

2984964 1970-74 Barracuda..... 299.99 ea
2984966 1970 Challenger..... 299.99 ea
2984964 1971-74 Challenger..... 299.99 ea



2984966

1970-74 E-Body Standard Tachometer

This non Rallye tach has a factory appearance, and bolts on the far right of the instrument panel where the block-off plate or optional clock would normally go. This tachometer is designed to work with many different types of ignition systems including breaker point, electronic and even MSD or Pertronix ignition systems. Easy installation instructions are included. For standard dash equipped 1970-74 E-Body vehicles.

ME1316 1970-74 E-Body tach..... 204.99 ea



New!



2984159



2984160



2984161

1970 Challenger Standard Gauges

OER® reproduction dash gauges for 1970 Dodge Challenger models with standard gauges. Manufactured to fit and function as original with correct fonts, authentic colors and markings. Officially licensed Mopar Authentic Restoration Product.

2984159 1970 fuel gauge..... 89.99 ea
2984160 1970 temp gauge..... 89.99 ea
2984161 1970 amp gauge..... 109.99 ea

New!



2984119



2984120



2984121

1970-74 E-Body Standard Gauges

OER® reproduction dash gauges for 1970-74 Plymouth Cuda and Barracuda models and 1971-74 Challenger models with standard gauges. Designed to fit and function as original with correct fonts, authentic colors and markings. Officially licensed Mopar Authentic Restoration Product.

Note: Not for use on 1970 Challenger.

2984119 1970-74 fuel gauge..... 89.99 ea
2984120 1970-74 temp gauge..... 89.99 ea
2984121 1970-74 amp gauge..... 109.99 ea

New!



2984952



2984174



5984140

1970-74 E-Body Dash Clock/Delete Plate

OER® reproduction dash clock or delete plate for 1970-74 Barracuda, Cuda, or Challenger models. Each clock is manufactured from stamped, die cut steel with correct markings and colors. These clocks are upgraded from mechanical to quartz movement components and are assembled using the best precision components to ensure accuracy and reliability. The officially licensed Mopar Authentic Restoration delete plates are injection molded and features the correct markings and takes the place of the dash clock on vehicles that were not equipped with a dash clock assembly.

*Note: *Except 1970 Challenger models.*

Dash Clock

2984952 1970 Challenger..... 279.99 ea
2984951* 1970-74 E-Body..... 279.99 ea

Dash Clock Delete Plate

2984174 1970 Challenger..... 49.99 ea
2984140* 1970-74 E-Body..... 49.99 ea

In-Dash Gauges



1968-70 B-Body Rally Speedometer

Rally speedometer for 1968-70 Dodge B-Body models and 1970 Plymouth models. Featuring correct white markings, each gauge is manufactured to exact factory specifications and is designed to replace the original gauge exactly.



1277440 1968-70 speedometer 299.99 ea



1968-70 B-Body Rally Tach/Clock

High quality combination tachometer/clock for 1968-70 Dodge and 1970 Plymouth B-Body models. Designed to replicate the original in every detail, gauge face features all correct markings and is calibrated at the factory. Ready to install!



1277441 1968-70 tach/clock combo 359.99 ea



RM4125 1968-70 Gauge Package with Tic-Toc-Tach



1968-70 B-Body Rally Clock

Rally clock for 1968-70 Dodge and 1970 Plymouth B-Body models. Manufactured to exact factory specifications, this clock features the correct white markings and is designed to replace the original gauge exactly.



1277445 1968-70 B-Body clock 239.99 ea



RM4126 1968-70 Gauge Package with Clock



1968-70 Mopar B-Body Rally Gauge Set

A complete gauge package for 1968-70 models equipped with Rallye gauges! This unique "all-in-one" set includes all six gauges including speedometer, tachometer, fuel gauge, oil pressure gauge, temperature gauge and amp gauge.

Gauge Set with Tic Toc Tach

RM4125 1968-70 Coronet, Charger, Super Bee set of 6 929.99 set
RM4125 1970 GTX, Road Runner, Staalite set of 6 929.99 set

Gauge Set with Clock

RM4126 1968-70 Coronet, Charger, Super Bee set of 6 819.99 set
RM4126 1970 GTX, Road Runner, Staalite set of 6 819.99 set

Note: Tic-toc-tach not included.

1968-70 B-Body Rallye Gauges

OER® reproduction dash gauges for 1968-70 Dodge and 1970 Plymouth B-Body models equipped with Rallye gauges. Manufactured to exact factory specifications, each gauge features correct white fonts and markings with white needles as original. Officially licensed Mopar Authentic Restoration Product.

1277443 1968-70 fuel gauge 79.99 ea
1277442 1968-70 temp gauge 79.99 ea
1277449 1968-70 oil press gauge 79.99 ea
1277453 1968-70 ammeter 79.99 ea

B DASH & CONSOLE COMPONENTS

In-Dash Gauges



RM4129 1972-74 Gauge Package with Tach & Clock



RM4127 1970-71 Gauge Package with Tach & Clock

1970-74 E-Body Rallye Gauge Set

A complete gauge package for 1970-74 E-Body models. Each gauge is meticulously manufactured to offer an authentic appearance. This complete set includes the Speedometer, Tachometer, Clock, Oil Gauge, Temperature Gauge, Fuel level and Ammeter gauge. This unique, "all-in-one" set of gauges is designed to replace all of the gauges in any original or reproduction dash gauge bezel.

Note: On 1970-71 models the reset knob protrudes through the gauge bezel and on 1972-74 models the reset knob protrudes through the gauge lens. The clock face is 1970 design and may differ cosmetically from the 1971 in-dash clock.

RM4127 1970-71 set of 7 gauges..... 1069.99 set
RM4129 1972-74 set of 7 gauges..... 1024.99 set



1970-71 E-Body Rallye Speedometer

Rallye speedometer for 1970-71 E-Body models. Featuring correct white markings, each gauge is manufactured to exact factory specifications and is designed to replace the original gauge exactly.

1277446 1970-71 speedometer..... 349.99 ea



1972-74 E-Body Rallye Speedometer

Rallye speedometer for 1972-74 E-Body models. Featuring correct white markings, each speedometer is manufactured to exact factory specifications and is designed to replace the original speedometer exactly.

2985954 1972-74 speedometer..... 349.99 ea



1970-74 E-Body Rallye Tachometer

This is a high quality reproduction tachometer for 1970-74 E-Body models equipped with the Rallye option. It is designed to duplicate the original in every detail. This tachometer face features all correct markings and color scheme. Correctly calibrated and ready to install.

1277447 1970-74 E-Body tach..... 229.99 ea



1970-74 E-Body Rallye Clock

High quality replacement instrument cluster clock for 1970-74 E-Body models. Manufactured to exact factory specifications featuring the correct white markings as original. Each clock will replace the original assembly exactly.

1277452 1970-71 E-Body clock..... 274.99 ea
2985947 1972-74 E-Body clock..... 249.99 ea



1277451

1277448

1277450

1277444

1970-74 E-Body Rallye Gauges

OER® reproduction dash gauges for 1970-74 E-Body models equipped with Rallye gauges. Manufactured to exact factory specifications, each gauge features correct fonts, white markings with red needles as original. Officially licensed Mopar Authentic Restoration Product.

1277451 1970-74 fuel gauge..... 79.99 ea
1277450 1970-74 temp gauge..... 79.99 ea
1277448 1970-74 oil press gauge..... 79.99 ea
1277444 1970-74 ammeter..... 79.99 ea

1970-74 E-Body Rally Dash Clock Cable Nut Tool



This tool is designed to remove the chrome cable adjustment nut for the Rallye clock on 1970-74 E-Body models without causing damage to the nut. Made in the USA.
MF1741 1970-74 E-Body..... 16.99 ea

Gauge Restoration



MA118501

MB192001



MA118503

MB192002

1962-75 Circuit Boards



Reproduction printed circuit boards for 1962-75 Mopar muscle car applications. These boards are made from flame-resistant fiberglass for strength and superior bonding with the copper traces. Nickel-plated connector pins and circuit traces prevent corrosion. Boards with voltage limiters also feature fully soldered socket connections instead of the faulty original press-on connections. Each board is fully tested for quality assurance.

Dash Circuit Boards

1962-76 A-Body

MA118501	1963-64	Plymouth A-Body	135.99	ea
MA118502	1963-65	Dart	129.99	ea
MA118503	1965	Valiant/Barracuda	124.99	ea
MA118504	1966	Dart/Canada Valiant	129.99	ea
MA118505	1966	Valiant	144.99	ea
MA118506	1966	Barracuda	47.99	ea
MA118507	1966	Barracuda	RH	97.99	ea
MA118508	1966	Barracuda	pair	134.99	pr
MA118509	1967-72	all w/Rallye	LH	124.99	ea
MA118510	1967-72	all w/Rallye	RH	49.99	ea
MA118511	1967-72	all w/Rallye	pair	154.99	pr
MA118512	1967-71	Dart w/o Rallye	LH	104.99	ea
MA118513	1967-71	Dart w/o Rallye	RH	94.99	ea
MA118514	1967-71	Dart w/o Rallye	pair	164.99	pr
MA118515	1967-75	Valiant	139.99	ea
MA118515	1972	Demon	139.99	ea
MA118515	1973-75	Dart Sport	139.99	ea
MA118516	1976	all models	149.99	ea

1962-74 B-Body

MB192001	1962-63	Plymouth B-Body	149.99	ea
MB192002	1964	Savoy, Fury	LH	114.99	ea
MB192003	1964	Savoy, Fury	RH	95.99	ea
MB192004	1964	Savoy, Fury	pair	169.99	pr
MB192005	1964	Polara	149.99	ea
MB192006	1965	Coronet	149.99	ea
MB192007	1965	Belvedere	LH	94.99	ea
MB192008	1965	Belvedere	RH	89.99	ea
MB192009	1965	Belvedere	pair	154.99	pr
MB192010	1966-67	Coronet	144.99	ea
MB192011	1966-67	Plymouth B-Body	LH	104.99	ea
MB192012	1966-67	Plymouth B-Body	RH	119.99	ea
MB192013	1966-67	Plymouth B-Body	pair	198.99	pr
MB192014	1968-70	all w/Rallye	114.99	ea
MB192015	1968-74	all w/standard dash	144.99	ea
MB192016	1971-74	all w/standard dash	129.99	ea

Tachometer Circuit Boards

Points or Electronic Ignition

MD165502	1964-66	A & B-Body	104.99	ea
MD165504	1967-69	A & B-Body	with console tach	84.99	ea
MD165506	1967	Barracuda	with Rallye dash	84.99	ea
MD165508	1967	Charger w/Rallye	with Rallye dash	84.99	ea
MD165508	1968-74	A, B & E-Body	with 7k tach	84.99	ea
ME159912	1972-74	E-Body	with 7k tach	84.99	ea

MSD style ignition

MD165501	1964-66	A & B-Body	104.99	ea
MD165503	1967-69	A & B-Body	with console tach	84.99	ea
MD165505	1967	Barracuda	with Rallye dash	84.99	ea
MD165505	1967	Charger	with Rallye dash	84.99	ea
MD165507	1968-74	A, B & E-Body	84.99	ea
ME159911	1972-74	E-Body	with 7k tach	84.99	ea

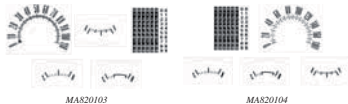

MAK20103

MAK20104



MAK20105

MAK20108

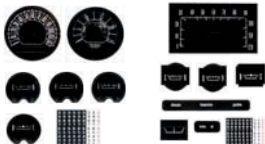

MAK20113

MAK20114

1960-75 A-Body Gauge Decal Sets

These decals are reproduced to duplicate the styles, fonts, and spacing of the original instrument faces. Machine-cut from high quality 3M material and designed to lie flat and wrinkle free. Made with a custom combination of printing and silk screening which results in vibrant markings against a semi-flat background finish. In fact, these are the only decals with an OE finish available on the market.

Without Rallye Gauges

MAK20101	1960	Valiant	110 MPH.....	45.99	set
MAK20102	1960	Valiant	180 KPH.....	45.99	set
MAK20103	1961	Valiant	110 MPH w/white face.....	45.99	set
MAK20104	1961	Valiant	180 KPH w/white face.....	45.99	set
MAK20105	1963	Valiant	45.99	set
MAK20106	1964	Valiant	45.99	set
MAK20106	1964	Barracuda	45.99	set
MAK20107	1964	Dart	45.99	set
MAK20108	1965	Barracuda	120 MPH.....	45.99	set
MAK20109	1965	Barracuda	180 KPH w/silver face.....	45.99	set
MAK20110	1965	Dart	120 MPH w/silver face.....	45.99	set
MAK20111	1965	Dart	180 KPH w/silver face.....	45.99	set
MAK20112	1966	Valiant	45.99	set
MAK20113	1966	Cuda	120MPH w/vacuum.....	45.99	set
MAK20114	1967	Valiant	45.99	set
MAK20115	1967-71	Dart	paint mask set.....	34.99	set
MAK20116	1968-69	Valiant	120 MPH.....	45.99	set
MAK20117	1970-71	Valiant	120 MPH.....	45.99	set
MAK20118	1972-75	Valiant	(after 10/71) 120 MPH.....	44.99	set
MAK20119	1976-77	Valiant	100 MPH.....	44.99	set
MAK20120	1971-72	Valiant	Mex Superbee 240 KPH.....	45.99	set

With Rallye Gauges

MAK20121	1966	Formula S	150 MPH w/tach.....	45.99	set
MAK20122	1967-69	A-Body	120 MPH Speedo w/rip odo.....	45.99	set
MAK20123	1967-69	A-Body	120 MPH Speedo w/rip odo.....	45.99	set
MAK20124	1967-69	A-Body	150 MPH Speedo w/rip odo.....	45.99	set
MAK20125	1970-71	A-Body	120 MPH Speedo w/rip odo.....	45.99	set
MAK20126	1970-71	A-Body	120 MPH Speedo w/o trip odo.....	45.99	set
MAK20127	1970-71	A-Body	150 MPH Speedo w/rip odo.....	45.99	set
MAK20128	1970-71	A-Body	200 KPH Speedo w/rip odo.....	45.99	set
MAK20129	1970-71	A-Body	200 KPH Speedo w/o trip odo.....	45.99	set
MAK20130	1970-71	A-Body	240 KPH Speedo w/rip odo.....	45.99	set

Gauge Restoration

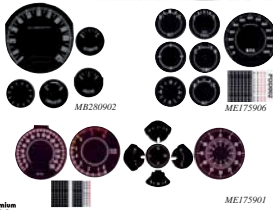

1962-74 B, E-Body Gauge Decal Sets



These decals are reproduced to duplicate the styles, fonts, and spacing of the original instrument faces. Machine-cut from high-quality 3M material and designed to lie flat and wrinkle free. Made with a custom combination of printing and silk screening which results in vibrant markings against a semi-flat background finish. In fact, these are the only decals with an OE finish available on the market.

Note: *Print mask set.

1962-74 B-Body

Without Rallye Gauges

MB280901	1962	Fury/Savoy	w/o AC	45.99	set
MB280902	1962	Sport Fury	w/AC	45.99	set
MB280903	1963	330/440		24.99	set
MB280903	1963	Polara		24.99	set
MB280905	1963	Fury/Savoy	w/o AC	49.99	set
MB280906	1963	Sport Fury	w/AC	49.99	set
MB280907	1964	Fury	w/clock	45.99	set
MB280908	1964	Fury	w/o clock	45.99	set
MB280909	1964	Coronet	w/o clock	45.99	set
MB280909	1964	Polara	w/o clock	45.99	set
MB280910	1965	Coronet	w/o clock	45.99	set
MB280911	1965	Belvedere	120 MPH w/o clock	45.99	set
MB280912	1965	Belvedere	200 MPH w/o clock	45.99	set
MB280913	1965	Belvedere	120 MPH w/o clock Police pkg.	45.99	set
MB280914	1966-67	Coronet	120 MPH w/o clock	45.99	set
MB280915	1966-67	Coronet	120 MPH w/clock	45.99	set
MB280916	1966-67	Coronet	150 MPH w/o clock	45.99	set
MB280917	1966-67	Coronet	120 MPH w/clock	45.99	set
MB280918	1966-67	Belvedere	120 MPH	45.99	set
MB280919	1966-67	Belvedere	150 MPH	45.99	set
MB280920	1966-67	Charger	150 MPH w/Tach (silkscreened)	78.99	set
MB280921	1968-70	B-body	120 MPH 'long tick'	34.99	set
MB280922	1968-70	B-body	150 MPH 'long tick'	34.99	set
MB280923	1968-70	B-body	120 MPH 'short tick'	34.99	set
MB280924	1968-70	B-body	150 MPH 'short tick'	34.99	set
MB280925	1968-70	B-body	w/Police (mask&decals)	39.99	set
MB280926	1971-74	B-body	sweep 120 MPH	45.99	set
MB280927	1971-74	B-body	w/Police pkg sweep 120 MPH	45.99	set

With Rallye Gauges

MB280928	1968-70	B-Body	150MPH	45.99	set
MB280929	1968-70	B-Body	240KPH OEM Export	45.99	set
MB280930	1968-70	B-Body	240KPH Full Metric	45.99	set
MB280931	1968-70	B-Body	240KPH Swedish	49.99	set
MB280932	1971-74	B Body	150 MPH w/Tach	49.99	set
MB280933	1971-74	B Body	150 MPH w/Clock	49.99	set
MB280935	1971-74	B Body	120 MPH w/Clock	49.99	set
MB280936	1971-74	B Body	150 MPH	45.99	set
MB280937	1971-74	B Body	120 MPH	45.99	set

1970-74 E-Body

With Rallye Gauges

ME175901	1970-71	150 MPH, 8k RPM		49.99	set
ME175902	1972-74	150 MPH, 7k RPM		49.99	set
ME175903	1970-71	240 KPH, 8k RPM		49.99	set
ME175904	1972-74	240 KPH, 7k RPM		49.99	set

Plymouth Without Rallye Gauges

ME175905	1970-74	120 MPH without clock		49.99	set
ME175906	1970-74	120 MPH with clock		49.99	set
ME175907	1970-74	200 KPH without clock		49.99	set
ME175908	1970-74	200 KPH with clock		49.99	set

Dodge Without Rallye Gauges

ME175909	1970	120 MPH		49.99	set
ME175910	1970	200 KPH		49.99	set
ME175911	1971-74	120 MPH		49.99	set
ME175912	1971-74	200 KPH		49.99	set



MN960134

1960-70 Odometer Decals

Restore your faded or worn A, B, E-Body odometers with these premium renumbering sets. Each set gives a factory new appearance with the correct fonts and colors.

MN960120	1960	Valiant		12.99	set
MN960121	1961	Valiant		12.99	set
MN960122	1963	Valiant		12.99	set
MN960123	1964	Dart		12.99	set
MN960122	1964	Valiant		12.99	set
MN960122	1964	Barracuda		12.99	set
MN960124	1965	Barracuda		12.99	set
MN960125	1965	Dart		12.99	set
MN960126	1966	Barracuda		12.99	set
MN960124	1966	Valiant		12.99	set
MN960127	1967	Valiant		12.99	set
MN960127	1967-71	Dart		12.99	set
MN960126	1967-71	all with Rallye		12.99	set
B-Body					
MN960128	1962-64	Belvedere		12.99	set
MN960128	1962-64	Savoy		12.99	set
MN960124	1962-64	Sport Fury		12.99	set
MN960124	1963	330, 440		12.99	set
MN960124	1963	Polara		12.99	set
MN960129	1964	Coronet		12.99	set
MN960129	1964	Polara		12.99	set
MN960130	1964	Fury		12.99	set
MN960130	1965	Belvedere		12.99	set
MN960131	1965	Coronet		12.99	set
MN960129	1966-67	Belvedere		12.99	set
MN960121	1966-67	Charger		12.99	set
MN960131	1966-67	Coronet		12.99	set
MN960127	1967	all		12.99	set
MN960131	1971-74	all without Rallye		12.99	set
MN960129	1971-74	all with Rallye		12.99	set
MN960133	1976-79	all with Rallye		12.99	set
E-Body					
MN960129	1970-74	all with standard		12.99	set
MN960134	1970-74	all with Rallye		12.99	set

1965-74 Supplemental Gauge Face Decals and Stencils

These decals are reproduced to duplicate the styles, fonts, and spacing of the original instrument faces. Machine-cut from high quality 3M material and designed to lie flat and wrinkle free. Made with a custom combination of printing and silk screening which results in vibrant markings against a correct semi-flat background finish. These are the only decals on the market with an OE finish. Use with our premium dash decal sets for complete restoration.

Note: *Installs on lens to cover over MPH markings. **Installs on speedometer, lens must have lettering removed.

A-Body

MA820135	1965	Barracuda Formula 5 dash tach face		12.99	ea
MA820136	1967-71	console tach face 6000 RPM		12.99	ea
MA820137	1968-76	Valiant 200 KPH speedo face		12.99	ea
MA820138	1968-76	Valiant 180 KPH speedo face		12.99	ea
MA820139	1968-76	Valiant 180 KPH CERTIFIED speedo face		12.99	ea
MA820140	1967-69	Rallye performance indicator face		12.99	ea
MA820141	1968-71	Rallye clock face		12.99	ea
MA820142	1967	Rallye tach face 6000 RPM		12.99	ea
MA820143	1968-71	Rallye tach face 6000 RPM		12.99	ea
MA820145	1967-71	Rallye clock delete print mask stencil		4.99	ea
MA820146	1968-71	Rallye tach face w/red 5500-6000 gauge		12.99	ea

B-Body

MB280941	1968-70	Rallye clock face set		12.99	set
MB280942	1968-70	Rallye tic toc tach clock/tach face set		12.99	set
MB280943	1968-70	Rallye clock outer face		12.99	ea
MB280944	1968-70	Rallye clock inner face		12.99	ea
MB280945	1968-70	Rallye tic toc tach face (outer)		14.99	ea
MB280946	1968-70	Rallye tic toc tach face (inner)		12.99	ea
MB280947	1968-70	Rallye clock/tach delete print mask stencil		12.99	ea
MB280948	1968-70	standard clock print mask stencil		14.99	ea
MB280949	1968-70	standard tach print mask stencil		14.99	ea
MB280950	1968-70	standard 200 KPH speedo lens decal		14.99	ea
MB280951	1968-70	standard 200 KPH speedo face		14.99	ea
MB280952	1971-74	Rallye 240 KPH speedo face		14.99	ea
MB280953	1971-74	Rallye 200 KPH speedo face		14.99	ea

Performance Gauges

6-Gauge Custom Instrument Panels For A, B & E-Body Models!

These panels feature 3-3/8" Speedometer and Tachometer, and 2-1/16" Oil Pressure, Water Temperature, Fuel Level and Voltmeter gauges. LED turn signal, parking brake, and high-beam indicators are included. See AutoMeter section for gauge details. Panels are also available without gauges to customize with the gauges of your choice.

Important: Sending unit for electric speedometers must be purchased separately. Sport Comp gauge sets feature mechanical gauges (except Tach, Fuel and Volt) and do not include a wire harness. Four 1/8" holes must be drilled for LED indicators.
Note: No further discounts apply.

Choose From Six Different Styles of Auto Meter Gauges!



american muscle

carbon fiber

phantom

ultra lite

sport comp

traditional

Choose From Three Panel Styles!



black

brushed aluminum

carbon fiber



MA18011A



1970-76 A-Body 6-Gauge Custom Instrument Panels

Smooth Black Gauge Panels				
Part #	Gauge Style	MPH	RPM	Price
MA18011A	American Muscle	160 mph	8000 RPM	1041.99 kit
MA18011B	Carbon Fiber	160 mph	10000 RPM	887.99 kit
MA18011C	Phantom	160 mph	10000 RPM	836.99 kit
MA18011D	Ultra Lite	160 mph	10000 RPM	855.99 kit
MA18011E	Sport Comp	120 mph	8000 RPM	656.99 kit
MA18011F	Traditional	160 mph	8000 RPM	833.99 kit
Brushed Aluminum Style Gauge Panels				
MA18012A	American Muscle	160 mph	8000 RPM	1117.99 kit
MA18012B	Carbon Fiber	160 mph	10000 RPM	944.99 kit
MA18012C	Phantom	160 mph	10000 RPM	836.99 kit
MA18012D	Ultra Lite	160 mph	10000 RPM	855.99 kit
MA18012E	Sport Comp	120 mph	8000 RPM	656.99 kit
MA18012F	Traditional	160 mph	8000 RPM	833.99 kit
Carbon Fiber Style Gauge Panels				
MA18013A	American Muscle	160 mph	8000 RPM	1041.99 kit
MA18013B	Carbon Fiber	160 mph	10000 RPM	887.99 kit
MA18013C	Phantom	160 mph	10000 RPM	836.99 kit
MA18013D	Ultra Lite	160 mph	10000 RPM	855.99 kit
MA18013E	Sport Comp	120 mph	8000 RPM	656.99 kit
MA18013F	Traditional	160 mph	8000 RPM	833.99 kit



MB29010F



1968-70 B-Body 6-Gauge Custom Instrument Panels

Smooth Black Gauge Panels				
Part #	Gauge Style	MPH	RPM	Price
MB29008A	American Muscle	160 mph	8000 RPM	1155.99 kit
MB29008B	Carbon Fiber	160 mph	10000 RPM	1001.99 kit
MB29008C	Phantom	160 mph	10000 RPM	950.99 kit
MB29008D	Ultra Lite	160 mph	10000 RPM	969.99 kit
MB29008E	Sport Comp	120 mph	8000 RPM	770.99 kit
MB29008F	Traditional	160 mph	8000 RPM	947.99 kit
Brushed Aluminum Style Gauge Panels				
MB29009A	American Muscle	160 mph	8000 RPM	1155.99 kit
MB29009B	Carbon Fiber	160 mph	10000 RPM	1001.99 kit
MB29009C	Phantom	160 mph	10000 RPM	950.99 kit
MB29009D	Ultra Lite	160 mph	10000 RPM	969.99 kit
MB29009E	Sport Comp	120 mph	8000 RPM	770.99 kit
MB29009F	Traditional	160 mph	8000 RPM	947.99 kit
Carbon Fiber Style Gauge Panels				
MB29010A	American Muscle	160 mph	8000 RPM	1155.99 kit
MB29010B	Carbon Fiber	160 mph	10000 RPM	1001.99 kit
MB29010C	Phantom	160 mph	10000 RPM	950.99 kit
MB29010D	Ultra Lite	160 mph	10000 RPM	969.99 kit
MB29010E	Sport Comp	120 mph	8000 RPM	770.99 kit
MB29010F	Traditional	160 mph	8000 RPM	947.99 kit



MB29013D



1971-74 B-Body 6-Gauge Custom Instrument Panels

Smooth Black Gauge Panels				
Part #	Gauge Style	MPH	RPM	Price
MB29011A	American Muscle	160 mph	8000 RPM	1117.99 kit
MB29011B	Carbon Fiber	160 mph	10000 RPM	963.99 kit
MB29011C	Phantom	160 mph	10000 RPM	912.99 kit
MB29011D	Ultra Lite	160 mph	10000 RPM	931.99 kit
MB29011E	Sport Comp	120 mph	8000 RPM	732.99 kit
MB29011F	Traditional	160 mph	8000 RPM	909.99 kit
Brushed Aluminum Style Gauge Panels				
MB29012A	American Muscle	160 mph	8000 RPM	1117.99 kit
MB29012B	Carbon Fiber	160 mph	10000 RPM	963.99 kit
MB29012C	Phantom	160 mph	10000 RPM	912.99 kit
MB29012D	Ultra Lite	160 mph	10000 RPM	931.99 kit
MB29012E	Sport Comp	120 mph	8000 RPM	732.99 kit
MB29012F	Traditional	160 mph	8000 RPM	909.99 kit
Carbon Fiber Style Gauge Panels				
MB29013A	American Muscle	160 mph	8000 RPM	1117.99 kit
MB29013B	Carbon Fiber	160 mph	10000 RPM	963.99 kit
MB29013C	Phantom	160 mph	10000 RPM	912.99 kit
MB29013D	Ultra Lite	160 mph	10000 RPM	931.99 kit
MB29013E	Sport Comp	120 mph	8000 RPM	732.99 kit
MB29013F	Traditional	160 mph	8000 RPM	909.99 kit

B DASH & CONSOLE COMPONENTS

Performance Gauges



MB23013C

Choose From Six Different Styles of Auto Meter Gauges!



Choose From Three Panel Styles!



1970-74 E-Body 6-Gauge Custom Instrument Panels

These panels feature 3-3/8" Speedometer and Tachometer, and 2-1/16" Oil Pressure, Water Temperature, Fuel Level and Voltmeter gauges. LED turn signal, parking brake, and high-beam indicators are included. See AutoMeter section for gauge details. Panels are also available without gauges to customize with the gauges of your choice.

Important: Sending unit for electric speedometers must be purchased separately. Sport Comp gauge sets feature mechanical gauges (except Tach, Fuel and Volt) and do not include a wire harness. Four 1/8" holes must be drilled for LED indicators.

Note: No further discounts apply.



Smooth Black Gauge Panels

Part #	Gauge Style	MPH	RPM	Price
ME2301A	American Muscle	160 mph	8000 RPM	1136.99 kit
ME2301B	Carbon Fiber	160 mph	10000 RPM	982.99 kit
ME2301C	Phantom	160 mph	10000 RPM	931.99 kit
ME2301D	Ultra Lite	160 mph	10000 RPM	950.99 kit
ME2301E	Sport Comp	120 mph	8000 RPM	751.99 kit
ME2301F	Traditional	160 mph	8000 RPM	928.99 kit

Brushed Aluminum Style Gauge Panels

ME2301A	American Muscle	160 mph	8000 RPM	1136.99 kit
ME2301B	Carbon Fiber	160 mph	10000 RPM	982.99 kit
ME2301C	Phantom	160 mph	10000 RPM	931.99 kit
ME2301D	Ultra Lite	160 mph	10000 RPM	950.99 kit
ME2301E	Sport Comp	120 mph	8000 RPM	751.99 kit
ME2301F	Traditional	160 mph	8000 RPM	928.99 kit

Carbon Fiber Style Gauge Panels

ME2301A	American Muscle	160 mph	8000 RPM	1136.99 kit
ME2301B	Carbon Fiber	160 mph	10000 RPM	982.99 kit
ME2301C	Phantom	160 mph	10000 RPM	931.99 kit
ME2301D	Ultra Lite	160 mph	10000 RPM	950.99 kit
ME2301E	Sport Comp	120 mph	8000 RPM	751.99 kit
ME2301F	Traditional	160 mph	8000 RPM	928.99 kit



MA1222



gauge shown with blue illumination

1970-76 6-Gauge Instrument Panels w/Mopar Performance Gauges

Get a modern custom appearance without losing your vehicle's authentic Mopar identity with these gauge kits from Classic Industries®. These full-sweep gauges are available with white or black faces and feature Mopar™ logo prominently in the center. Soft blue illumination brings a 21st-century touch to your classic muscle car.

Note: No further discounts apply.



1970-76 A-Body

Part #	Panel Style	Gauges	RPM	MPH	Price
MA12221	black	white	10,000	160	1244.99 kit
MA12222	black	black	10,000	160	1244.99 kit
MA12223	aluminum	white	10,000	160	1244.99 kit
MA12224	aluminum	black	10,000	160	1225.99 kit
MA12225	carbon fiber	white	10,000	160	1225.99 kit
MA12226	carbon fiber	black	10,000	160	1225.99 kit

1968-70 B-Body

MB27001	black	white	10,000	160	1320.99 kit
MB27002	black	black	10,000	160	1320.99 kit
MB27003	aluminum	white	10,000	160	1320.99 kit
MB27004	aluminum	black	10,000	160	1320.99 kit
MB27005	carbon fiber	white	10,000	160	1320.99 kit
MB27006	carbon fiber	black	10,000	160	1320.99 kit

1971-74 B-Body

MB27201	black	white	10,000	160	1320.99 kit
MB27202	black	black	10,000	160	1320.99 kit
MB27203	aluminum	white	10,000	160	1320.99 kit
MB27204	aluminum	black	10,000	160	1320.99 kit
MB27205	carbon fiber	white	10,000	160	1320.99 kit
MB27206	carbon fiber	black	10,000	160	1320.99 kit

1970-74 E-Body

ME12221	black	white	10,000	160	1339.99 kit
ME12222	black	black	10,000	160	1339.99 kit
ME12223	aluminum	white	10,000	160	1339.99 kit
ME12224	aluminum	black	10,000	160	1339.99 kit
ME12225	carbon fiber	white	10,000	160	1339.99 kit
ME12226	carbon fiber	black	10,000	160	1339.99 kit



MN1230



MN1231

Individual Mopar Performance Gauges

Individual Mopar Performance gauges for all models. Choose from speedometer, tachometer, water temperature, oil pressure, fuel level or voltmeter for aftermarket panels or other mounting locations. Available in white or black face gauges that illuminate blue at night. Features the Mopar™ logo on the face and are all full-sweep gauges.

Note: No further discounts apply.



White Face Gauges

MN1220	speedometer	3-3/8"	160 MPH, electric	329.99 ea
MN1222	tachometer	3-3/8"	10,000 RPM	244.99 ea
MN1224	fuel level	2-1/16"		159.99 ea
MN1226	water temp	2-1/16"	100-260°F	189.99 ea
MN1228	oil pressure	2-1/16"	0-100 PSI	90.99 ea
MN1230	voltmeter	2-1/16"	8-18 volts	89.99 ea

Black Face Gauges

MN1221	speedometer	3-3/8"	160 MPH, electric	349.99 ea
MN1223	tachometer	3-3/8"	10,000 RPM	244.99 ea
MN1225	fuel level	2-1/16"		159.99 ea
MN1227	water temp	2-1/16"	100-260°F	189.99 ea
MN1229	oil pressure	2-1/16"	0-100 PSI	94.99 ea
MN1231	voltmeter	2-1/16"	8-18 volts	89.99 ea

Digital Gauge Sets

Digital 6-Gauge Custom Instrument Panels For A, B & E-Body Models!

Take your Mopar into the 21st century with these custom gauge sets, featuring modern digital instrumentation from Dakota Digital and LED indicator lights. These gauges are designed for maximum visibility and readability, even in intense sunlight and under high-vibration conditions that performance vehicles may endure. Available in your choice of chrome or black bezel with teal or blue display.

Choose From Four Different Styles of Dakota Digital Gauges!



MA12201



MA12207



MA12209



MB27102



MB27106



MB27112

1970-76 A-Body Digital 6-Gauge Instrument Panels

These panels feature 3-3/8" Speedometer and Tachometer, and 2-1/16" Oil Pressure, Water Temperature, Fuel Level and Voltmeter gauges. LED turn signal, parking brake, and high-beam indicators are included. Panels are also available without gauges to customize with the gauges of your choice.

Important: Gauge panels do not include a wire harness. Four 1/8" holes must be drilled for LED indicators.

Note: No further discounts apply.



Smooth Black Gauge Panels

Part #	Display	Bezel	Price
MA12201	teal	chrome	859.99 kit
MA12202	teal	black	859.99 kit
MA12203	blue	chrome	883.99 kit
MA12204	blue	black	883.99 kit

Brushed Aluminum Style Gauge Panels

Part #	Display	Bezel	Price
MA12205	teal	chrome	859.99 kit
MA12206	teal	black	859.99 kit
MA12207	blue	chrome	883.99 kit
MA12208	blue	black	883.99 kit

Carbon Fiber Style Gauge Panels

Part #	Display	Bezel	Price
MA12209	teal	chrome	859.99 kit
MA12210	teal	black	859.99 kit
MA12211	blue	chrome	883.99 kit
MA12212	blue	black	883.99 kit

1971-74 B-Body Digital 6-Gauge Instrument Panels

These panels feature 3-3/8" Speedometer and Tachometer, and 2-1/16" Oil Pressure, Water Temperature, Fuel Level and Voltmeter gauges. LED turn signal, parking brake, and high-beam indicators are included. Panels are also available without gauges to customize with the gauges of your choice.

Important: Four 1/8" holes must be drilled for LED indicators.

Note: No further discounts apply.



Smooth Black Gauge Panels

Part #	Display	Bezel	Price
MB27101	teal	chrome	935.99 kit
MB27102	teal	black	935.99 kit
MB27103	blue	chrome	959.99 kit
MB27104	blue	black	959.99 kit

Brushed Aluminum Style Gauge Panels

Part #	Display	Bezel	Price
MB27105	teal	chrome	935.99 kit
MB27106	teal	black	935.99 kit
MB27107	blue	chrome	959.99 kit
MB27108	blue	black	959.99 kit

Carbon Fiber Style Gauge Panels

Part #	Display	Bezel	Price
MB27109	teal	chrome	935.99 kit
MB27110	teal	black	935.99 kit
MB27111	blue	chrome	940.99 kit
MB27112	blue	black	959.99 kit

Digital Gauge Sets

Choose From Three Panel Styles!

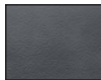

black



brushed aluminum



carbon fiber



MEI2209



MEI2212

1970-74 E-Body Digital 6-Gauge Instrument Panels

These panels feature 3-3/8" Speedometer and Tachometer, and 2-1/16" Oil Pressure, Water Temperature, Fuel Level and Voltmeter gauges. LED turn signal, parking brake, and high-beam indicators are included. Panels are also available without gauges to customize with the gauges of your choice.

Important: Four 1/8" holes must be drilled for LED indicators.
 Note: No further discounts apply.



Smooth Black Gauge Panels

Part #	Display	Bezel	Price
MEI12201	teal	chrome	954.99 kit
MEI12202	teal	black	954.99 kit
MEI12203	blue	chrome	978.99 kit
MEI12204	blue	black	978.99 kit

Brushed Aluminum Style Gauge Panels

Part #	Display	Bezel	Price
MEI12205	teal	chrome	954.99 kit
MEI12206	teal	black	954.99 kit
MEI12207	blue	chrome	959.99 kit
MEI12208	blue	black	959.99 kit

Carbon Fiber Style Gauge Panels

Part #	Display	Bezel	Price
MEI12209	teal	chrome	954.99 kit
MEI12210	teal	black	954.99 kit
MEI12211	blue	chrome	978.99 kit
MEI12212	blue	black	978.99 kit

New!



DD86013



DD86021



1968-70 B-Body VHX Instruments

VHX Systems fit directly into the stock Rallye gauge bezel of 1968-70 B-Body models without modification, adding a wealth of features to this iconic vehicle. Features fully lit needles, backlit faces and easy-to-read LCD message centers, the VHX series is a far cry from yesterday's traditional instrumentation. Mounts directly to the stock dash housing for simple installation. The VHX series is loaded with features including micro-controlled precision stepper motors, solid state sensors for unparalleled accuracy and user-customizable display feedback. Available in black or silver alloy face, with either blue, red, or white numeration and backlighting. Please specify blue, red, or white illumination when ordering.

Note: Gauge bezel not included.

DD8601	1968-70	black alloy	945.99 set
DD8602	1968-70	silver alloy	945.99 set

New!



MEI1596



black



brushed aluminum



carbon fiber

Classic
 Thunder Road

Custom ABS Gauge Panels

Thermo-formed ABS gauge panels are designed with rigid base materials, heavy-duty mounting bosses, and deep recessed gauge pockets to provide a high performance appearance. The small gauge openings measure 2-1/16" and the speedo and tach openings measure 3-3/8". Available with a textured black, simulated brushed aluminum, or simulated carbon fiber finish.

Note: These panels do not feature the provision for the convertible top switch.

A-Body

MA1130	1970-76	black	219.99 ea
MA1131	1970-76	brushed aluminum	219.99 ea
MA1132	1970-76	carbon fiber	219.99 ea

B-Body

MB192071	1968-70	black	309.99 ea
MB192072	1968-70	brushed aluminum	309.99 ea
MB192073	1968-70	carbon fiber	309.99 ea
MB1847	1971-74	black	289.99 ea
MB1848	1971-74	brushed aluminum	289.99 ea
MB1849	1971-74	carbon fiber	289.99 ea

E-Body

MEI1594	1970-74	black	289.99 set
MEI1595	1970-74	brushed aluminum	289.99 set
MEI1596	1970-74	carbon fiber	289.99 set

Performance Gauges



Bosch Super Tac II

Bosch's Super Tac II features internal dial lighting, accurate air coil meters, 250° dial sweep, 8,000RPM limit and adjustable red line pointer. Works on 4, 6 or 8 cylinder engines. Functions with breaker-point, electronic and most aftermarket ignition systems except magnetos. Includes mounting hardware. Available in 3-3/8" or 2-5/8".

- 3-3/8" Super Tac II**
ST7901 black dial, chrome bezel 31.99 ea
ST7903 white dial, chrome bezel 41.99 ea
- 2-5/8" Super Tac II**
ST7904 white dial, black bezel 31.99 ea
ST7906 black dial, black bezel 31.99 ea
ST7911 white dial, chrome bezel 31.99 ea



Bosch Retro Tachometers

Carefully reproduced to match original dimensions. 360° lighting avoids uneven spots for better night visibility. These tachometers will put the finishing touches on your restoration project. Tachometer measures 3-3/8" and has 8,000 RPM limit.

Important: Tachometers operate on 1, 2, 4, 6, 8 or 10 cylinder engines with most factory or aftermarket ignition systems.
ST8802 full sweep w/adj. redline 109.99 ea
ST88R short sweep 109.99 ea



Bosch Super Tac III

Solid metal casing with a striking reflective chrome finish. Features a blue shift light. The Super Tac III is fast, accurate and reliable, thanks to vibration proof air-core meter construction. 0-10,000 RPM. Internal settings for 2, 4, 6 and 8 cylinder engines. Pointer return to zero feature. Adjustable swivel mounting foot for mounting at any angle. Modern DIS applications are covered by the 2 cylinder setting.

- ST7905 black dial, chrome bezel 82.99 ea

New!



ST8090



ST8091

Bosch 1-1/2" Mini-Triple Gauge Set

Sets include 1-1/2" dial gauges, mechanical oil/water temperature gauge, volt meter, mechanical oil pressure gauge. Includes 72" capillary tubing with 5/8" NPT thread and 1/4", 3/8" and 1/2" adapters. Requires hook up wire for voltmeter. Features 12 volt internal lighting. Designed for 12 volt negative ground systems. Available with black face gauges/chrome gauge bezels/black panel, white face gauges/black gauge bezels/black panel, or white face gauges/chrome gauge bezels/chrome panel.
ST8090 black face/black panel 31.99 set
ST8091 white face/black panel 34.99 set
ST8092 white face/chrome panel 31.99 set



DD1041C

DD1042K

Digital Clock Instruments

Odyssey digital clock incorporates a 12 hour AM/PM format, ambient temperature display, and either an 8-point compass or a day/date display. Features night dimming and label illumination behind a non-glare, high-contrast lens. Measures 2-1/16" diameter x 1-1/2" housing x 2-3/8" deep (including mounting studs). Sensors included. 24-month limited warranty. *Note:* Special order. Must be prepaid, non-returnable.

Clock/Day-Date/Temperature Gauge

- Odyssey Series II with Teal Illumination**
DD1041K black bezel 79.99 ea
DD1041C chrome bezel 179.99 ea
- Odyssey Solaris with Blue Illumination**
DD1042B blue bezel 179.99 ea
DD1042K black bezel 179.99 ea
DD1042C chrome bezel 179.99 ea

Clock/Compass/Temperature Gauge

- Odyssey Series II with Teal Illumination**
DD1043K black bezel 314.99 ea
DD1043C chrome bezel 314.99 ea
- Odyssey Solaris with Blue Illumination**
DD1044K black bezel 314.99 ea
DD1044C chrome bezel 314.99 ea

Marshall
INSTRUMENTS



MG01604S

MG015021A



MG015031B

MG015033C



MG015035B

MG015044A



MG018092A

MG015096B

Marshall Instruments SCX & SCX Gauges

SCX Pro gauges feature one-touch peak recall and programmable high and low full dial warning. There is also an external alarm output (12V, 500mA) that can be used to activate an external warning light when an alarm condition exists. Superior amber and white through-the-dial lighting and illuminated pointer. All SCX and SCX Pro fuel senders work with 0-100, 240-33, 73-10, 20-150 and 0-30 Ohm senders. SCX Series 5" tachometers feature a slimline case design (only 2" deep). *Note:* *Pedestal mount. **Pedestal mount w/LED shift light.

SCX Pro Series Gauges

- MG016048 8-18 wideband A/F ratio 89.99 ea

SCX Series Gauges

- Note:* Must specify dial color suffix SCX Series Gauges - A=black, B=white, C=blue
MG015021 8-18 volt 79.99 ea
MG015031 vac/boost w/MAP sensor 149.99 ea
MG015033 0-100 PSI oil pressure 89.99 ea
MG015035 100°-260° F water temp 79.99 ea
MG015035 170°-300° F oil temp 79.99 ea
MG015037 100°-260° F trans temp 79.99 ea
MG015041 0-1600 PSI nitrous 184.99 ea
MG015043 0-100 PSI fuel pressure 174.99 ea
MG015044 programmable fuel level 79.99 ea
MG015051 0-10000 rpm 3 3/8" 119.99 ea
MG015052 0-160 mph 3 3/8" speedo 149.99 ea
MG013092* 0-10000 rpm 5" tach 149.99 ea
MG015096** 0-10000 rpm 5" tach 189.99 ea

Performance Gauges

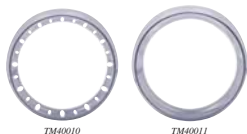

Billet Gauge Bezels

Twist Machine billet aluminum bezels fit over your existing Auto Meter® gauges without modification or disassembling your dash. These billet bezels attach to your gauges by way of pressure activated silicone "dots". Simply clean your gauges, apply the dots, then press your new bezels in place. Available with or without holes in face, individually or in sets.

Individual Bezels	
TM40011 5", without holes.....	44.99 ea
TM40013 3-3/8", with holes.....	44.99 ea
TM40014 3-3/8", without holes.....	44.99 ea
TM40015 2-5/8", with holes.....	44.99 ea
TM40016 2-5/8", without holes.....	24.99 ea
TM40017 2-1/16", with holes.....	19.99 ea
6 Pack Bezel Sets	
TM40051 2-5", 4-2-5/8", with holes.....	209.99 set
TM40052 2-5", 4-2-1/16", with holes.....	209.99 set

New!



Internal Float Fuel Sending Unit

Get reliable fuel gauge readings with this internal-float fuel sending unit. This advanced design provides accurate readings without fluctuations due to fuel slosh. Because this internal-float design requires no float arm, it is far more resistant to corrosion, even with racing fuels. All sending units mount to the tank with the standard 5 bolt mounting flange and are available in sizes from 4" to 24".

Note: Sending units are available in lengths from 4" to 24" and are sold in 1" increments.

Important: Sending unit should not touch bottom of tank. When the fuel gauge reads empty, the area below the sending unit is reserve fuel.

0-90 Ohm	
AS1010 4" - 12" sending units.....	79.99 ea
AS1011 13" - 24" sending units.....	99.99 ea
240-33 Ohm	
AS1012 4" - 12" sending units.....	79.99 ea
AS1013 13" - 24" sending units.....	89.99 ea



Sky Drive GPS Speedometer Sender

Drive your speedometer accurately and reliably with the Sky Drive GPS Speedometer sender. This device quickly calibrates and accurately drives any electronic programmable speedometer. The Sky Drive updates 10 times per second without any transmission signals, pulse generators or signal converters and features an omnidirectional antenna that can be mounted virtually anywhere and in any position. No more guessing or re-calibrating due to tire or gear changes; this unit requires a one time setup and you're done.

280665 Sky Drive speedometer sender.....	289.99 ea
--	-----------



Gauge Mount Panels

Mount your aftermarket 2-1/16" and 2-5/8" gauges the old school way on these aluminum mounting plates. Manufactured in aluminum for strength, these gauge panels also give your interior a no-nonsense look. Gauge mount brackets sold separately. Gauge bracket kits include a set of brackets and hardware to mount 3 gauges. *Note: No further discounts apply.*

For 2-1/16" Gauges	
AM2236 1-hole panel.....	17.99 ea
AM2237 2-hole panel.....	19.99 ea
AM2238 3-hole panel.....	21.99 ea
For 2-5/8" Gauges	
AM3231 1-hole panel.....	21.99 ea
AM3232 2-hole panel.....	19.99 ea
AM3233 3-hole panel.....	21.99 ea
Gauge Mounting Brackets	
AM2230 2-1/16" - set of 3.....	9.99 set
AM3245 2-5/8" - set of 3.....	11.99 set



Auto Meter Prestige In-Dash Gauges

Auto Meter's new Prestige Series gauges have the precision and reliability you've come to expect from Auto Meter, but with a stunning new look. These gauges achieve their elegant style with brushed aluminum centers, fully lit vintage-style needles, domed lenses, and polished chrome bezels. Antique Ivory gauges have black numerals and needles, and feature an LED fully lit gauge face when illuminated at night. The Prestige Black Diamond gauges have white numerals and needles and feature through-the-dial LED lighting to illuminate the numbers, markers, and needles. Mechanical gauges include the necessary fittings and 6 feet of capillary tubing (unless otherwise specified). Electric gauges include the required sending units. *Note: No further discounts apply.*

Antique Ivory	
AM2017 fuel 2-1/16" 240-33 ohm.....	84.99 ea
AM2021 oil press 2-1/16" 0-100 mechanical.....	119.99 ea
AM2027 oil press 2-1/16" 0-100 electric.....	109.99 ea
AM2032 water temp 2-1/16" 120-240 mechanical.....	139.99 ea
AM2037 water temp 2-1/16" 100-250 electric.....	94.99 ea
AM2087 speedo 3-3/8" 0-120 MPH w/LCD odometer.....	299.99 ea
AM2089 speedo 3-3/8" 0-120 MPH w/wheel odometer.....	299.99 ea
AM2092 voltmeter 2-1/16" 8-18 electric.....	84.99 ea
AM2097 tach 3-3/8" 0-8,000.....	239.99 ea
Black Diamond	
AM2016 fuel 2-1/16" 240-33 ohm.....	84.99 ea
AM2022 oil press 2-1/16" 0-100 mechanical.....	119.99 ea
AM2028 oil press 2-1/16" 0-100 electric.....	109.99 ea
AM2033 water temp 2-1/16" 120-240 mechanical.....	139.99 ea
AM2038 water temp 2-1/16" 100-250 electric.....	94.99 ea
AM2086 speedo 3-3/8" 0-120 MPH w/LCD odometer.....	299.99 ea
AM2088 speedo 3-3/8" 0-120 MPH w/wheel odometer.....	299.99 ea
AM2093 voltmeter 2-1/16" 8-18 electric.....	84.99 ea
AM2096 tach 3-3/8" 0-8,000.....	239.99 ea



In-Dash Speedos & Tachs

Our In-Dash Speedometers and Tachometers feature our famous high performance movements and are designed with seamless dashboard mount in mind for the ultimate driver information center. Available in a variety of configurations and sizes to accommodate diverse applications.

Pedestal Mount Tachometers

Mountable in every conceivable position, the versatility and durability of our Pedestal Mount Tachometers have made them a race proven favorite for over 30 years. These tachometers offer a variety of performance oriented options from shift lights to memory recall functions, coupled with a trademarked aluminum and rubber shock strap design for the best vibration protection available.

Full Sweep Mechanical Gauges

Bronze bourdon tube 270 degree sweep movements and durable nylon gearing have made these rugged and long lasting gauges proven high performance favorite for over 25 years. These mechanical gauges require no electrical power for operation making them an ideal choice for vehicles with no or low powered electrical systems.

Full Sweep Electric Gauges

Powered by digital microprocessor-controlled, rugged stepper motor drives and laboratory grade sending units, Full Sweep Electric Gauges are the best gauges available. They combine extreme durability & readability of 270 degree sweep mechanical gauges with the easy installation and safe operation of short sweep electrics. Track tested & race proven, these units use precision senders to keep hazardous fluids out of the driver's compartment and perform gauge calibration and sensor diagnostics at power up for extreme accuracy, every time.

Short Sweep Electric Gauges

Advanced 90 degree air core movements and three wire installation characterize these Short Sweep Electric Gauges. Electric sending units keep hazardous fluids in the engine compartment, sending collected data via an electrical signal to quickreacting, precise air core movements to give you all the information that you need.

Important: Electric speedometers operate on 500-100,000 pulses/mile sensing units. Existing sender if vehicle is originally equipped with an electric speedometer. Use AM5291 to convert from mechanical drive to electric. Tachometers operate on 4, 6, or 8 cylinder engines with most factory or aftermarket ignitions. Some fuel gauges use the vehicle's wack sending unit. Measure resistance using an ohmmeter with the sending unit float in the empty and full position to determine the correct fuel gauge.
Note: All Auto Meter gauges are discount exempt.

ULTRA-LITE

Ultra Lite gauges feature aluminum construction that greatly reduces weight while satin anodized Super Bezels and dials with black numbering and increments. Perimeter incandescent white lighting and bright red fluorescent pointers make them easy to read.



Z-Series gauges feature race quality mechanisms, a black Super Bezel with black dial, white numbers and increments, bright orange pointers and perimeter incandescent lighting that make this line easy to read.



Phantom II gauges feature black Super Bezels and white dials with black outlined, white numbering and black increments, "through-the-dial" patented LED lighting technology and glowing red pointers for superior visibility. When illuminated, the gauges display in a reverse configuration (black dial with white numbers and markings).



NV gauges feature bright anodized Super Bezels and white dials with black numbering and increments, intense green "full-dial" patented LED lighting technology and glowing orange pointers for superior visibility.



Phantom gauges are race quality mechanisms featuring a subtle black bezel with stark white dials, bright orange pointers and perimeter incandescent lighting that make this extensive high performance line easy to read with a crisp, no-nonsense modern appearance.



C₂ gauges feature bright anodized Super Bezels and white dials with black numbering and increments, intense blue "full-dial" patented LED lighting technology and glowing orange pointers for superior visibility. The light intensity can be controlled through an LED Lighting Dimmer (available separately) independent of your OE dash lighting.

NEXUS

Nexus gauges feature a bright Super Bezel and black dial with red accent band. The lens is dark tinted for a low key appearance when off. When illuminated, the patented LED lighting technology provides lighted pointer and "through-the-dial" display.



Ultra Lite II gauges feature satin anodized Super Bezels and dials with black numbering and increments, white "through-the-dial" patented LED lighting technology and glowing red pointers for superior visibility. When illuminated, the gauges display in a reverse configuration (black dial with white numbers and amber accents).



VES

ES gauges feature black satin Super Bezels and black dials with white numbering and increments, intense red "through-the-dial" patented LED lighting technology and glowing red pointers for superior visibility. The light intensity can be controlled through an LED Lighting Dimmer (available separately) independent of your OE dash lighting.

COBALT

Cobalt gauges feature bright anodized Super Bezels and black dials with blue accents, white numbering and increments, cobalt blue "through-the-dial" patented LED lighting technology and glowing orange pointers for superior visibility. The light intensity can be controlled through an LED Lighting Dimmer (available separately) independent of your OE dash lighting.

Carbon Fiber

Carbon Fiber gauges give your interior the complete look of rapid acceleration even when the car isn't moving. The clean, ray look of a crisp anodized aluminum bezel, an actual carbon fiber dial face, silver pointer and yellow accents with perimeter incandescent lighting give these gauges high visibility and style for any application.



Sport Comp II gauges feature a satin anodized Super Bezel and black dials with white numbering and increments, "through-the-dial" patented LED lighting technology and glowing red pointers for superior visibility. The light intensity can be controlled through an LED Lighting Dimmer (available separately) independent from your OE dash lighting.

AMERICAN MUSCLE

The American Muscle Street Rod Series features advanced hybrid dial technology combining Auto Meter's signature white Hi-Def LED illumination and fluorescent red pointers for maximum readability. The light intensity can be controlled through the optional LED Lighting Dimmer independently of your OE dash lighting (available separately).

SPORT-H-COMP

Sport Comp gauges feature the trademarked competition appearance and rugged, reliable performance of a satin anodized Super Bezel with black dials with white numbers and increments, bright orange pointers and perimeter incandescent lighting that make this extensive high performance line easy to read with a crisp, no-nonsense modern appearance.

TRADITIONAL CHROME™

Traditional Chrome gauges feature the trademarked competition appearance and rugged, reliable performance of a chrome bezel with black dial, white numbers and increments, bright orange pointers and perimeter incandescent lighting that make this line easy to read with a crisp, no-nonsense nostalgic appearance.





Performance Gauges



American Muscle



C-Series



Carbon Fiber



Cobalt



ES Series



Nexus



NV Series

Note: All Auto Meter gauges are 140-340 volt.

Cylinder Head Temp 140-340°F

- Short Sweep Electrical, 2-1/16"**
 Includes 1/8" NPT sender
- AM336 Sport Comp. 59.99 ea
- AM436 Ultra Lite. 59.99 ea
- Short Sweep Electrical, 2-5/8"**
 Includes 1/8" NPT sender.
- AM336 Sport Comp. 71.99 ea

Differential Temp 100-250°F

- Short Sweep Electrical, 2-1/16"**
 Includes 1/8" NPT sender.
- AM5749 Phantom. 64.99 ea
- AM3349 Sport Comp. 61.99 ea
- AM339 Ultra Lite. 64.99 ea
- Fuel Level - 0 to empty / 90 Q full**
- Short Sweep Electrical, 2-1/16"**
- AM1114 MCX. 59.99 ea
- Fuel Level - 0 to empty / 200 Q full**
- Full Sweep Electrical, 2-1/16"**

- AM7114 C2. 141.99 ea
- AM6614 Cobalt. 144.99 ea
- ES. 156.99 ea
- AM7310 NV. 156.99 ea
- AM5710 Phantom. 134.99 ea
- AM7510 Phantom II. 141.99 ea
- AM3310 Sport Comp. 129.99 ea
- AM3410 Sport Comp II. 134.99 ea
- AM4310 Ultra Lite. 141.99 ea
- AM4910 Ultra Lite II. 141.99 ea

Fuel Level - 200 Q empty / 33 Q full

- Short Sweep Electrical, 2-1/16"**
 Use AM2362 sender.
- AM1217 Amer. Musc. 81.99 ea
- AM1716 C2. 75.99 ea
- AM4716 Carbon Fiber. 64.99 ea
- AM6616 Cobalt. 75.99 ea
- AM5916 ES. 75.99 ea
- AM1716 MCX. 59.99 ea
- AM7316 NV. 75.99 ea
- AM5716 Phantom. 54.99 ea
- AM7516 Phantom II. 69.99 ea
- AM3316 Sport Comp. 54.99 ea
- AM3616 Sport Comp II. 69.99 ea
- AM2516 Traditional. 49.99 ea
- AM4316 Ultra Lite. 55.99 ea
- AM4916 Ultra Lite II. 69.99 ea
- AM2643 Z-Series. 45.99 ea

- Short Sweep Electrical, 2-5/8"**
 Use AM2362 sender.
- AM4816 Carbon Fiber. 76.99 ea
- AM5916 Cobalt. 85.99 ea
- AM5816 Phantom. 61.99 ea
- AM7816 Phantom II. 76.99 ea
- AM3316 Sport Comp. 59.99 ea
- AM7616 Sport Comp II. 76.99 ea
- AM4416 Ultra Lite. 66.99 ea
- AM7716 Ultra Lite II. 76.99 ea

Fuel Pressure 0-15 psi

- Full Sweep Mechanical, 2-1/16"**
 Carbureted, requires #4 braided line and mounting cup and must be mounted outside of vehicle.
 Note: Includes isolator & 4' line.
- AM4711 Carbon Fiber. 74.99 ea
- AM3311 Sport Comp. 61.99 ea
- AM2411 Traditional. 55.99 ea
- AM2431 Traditional. 169.99 ea
- AM4431 Ultra Lite. 64.99 ea
- AM4313 Ultra Lite. 175.99 ea
- AM2603 Z-Series. 56.99 ea

- Full Sweep Electrical, 2-1/16"**
 Carbureted, includes 1/8" NPT sender and 8' wiring harness.
 Note: *w/peuk & warning.
- AM1762 C2. 239.99 ea
- AM6162 Cobalt. 239.99 ea
- AM7362 NV. 239.99 ea
- AM5761 Phantom. 231.99 ea
- AM3361 Sport Comp. 231.99 ea
- AM3661 Sport Comp II. 214.99 ea
- AM4361 Ultra Lite. 234.99 ea
- AM4367 Ultra Lite. 254.99 ea
- AM4961 Ultra Lite II. 214.99 ea
- AM2661 Z-Series. 219.99 ea

- Full Sweep Mechanical, 2-5/8"**
 Carbureted, requires #4 braided line and mounting cup and must be mounted outside vehicle.
 Note: Includes isolator & 4' line. Requires braided line to fuel source.
- AM4811 Carbon Fiber. 84.99 ea
- AM4813 Carbon Fiber. 204.99 ea
- AM7911 Cobalt. 94.99 ea
- AM5810 Phantom. 66.99 ea
- AM5813 Phantom II. 184.99 ea
- AM7811 Phantom II. 84.99 ea
- AM3411 Sport Comp. 61.99 ea
- AM3413 Sport Comp. 175.99 ea
- AM7611 Sport Comp II. 84.99 ea
- AM4411 Ultra Lite. 69.99 ea
- AM4413 Ultra Lite. 189.99 ea
- AM7711 Ultra Lite II. 84.99 ea

- Full Sweep Electrical, 2-5/8"**
 Carbureted, includes 1/8" NPT sender and 8' wiring harness.
 Note: *w/peuk & warning.
- AM4812 Carbon Fiber. 255.99 ea
- AM7861 Phantom II. 231.99 ea
- AM3361 Sport Comp. 245.99 ea
- AM7661 Sport Comp II. 231.99 ea
- AM4461 Ultra Lite. 241.99 ea
- AM4471 Ultra Lite. 275.99 ea
- AM7761 Ultra Lite II. 231.99 ea

- Fuel Pressure 0-30 psi**
- Full Sweep Electrical, 2-1/16"**
 Fuel Injected, Includes 1/8" NPT sender and 8' wiring harness.
- AM6161 Cobalt. 239.99 ea
- AM5760 Cobalt. 251.99 ea
- AM4360 Ultra Lite. 249.99 ea
- AM2660 Z-Series. 219.99 ea

- Fuel Pressure 0-100 psi**
- Full Sweep Mechanical, 2-1/16"**
 Fuel Injected, Requires #4 braided line and mounting cup and must be mounted outside of vehicle.
- AM4711 Carbon Fiber. 74.99 ea
- AM5712 Phantom. 65.99 ea
- AM3312 Sport Comp. 65.99 ea
- AM2412 Traditional. 59.99 ea
- AM4312 Ultra Lite. 64.99 ea
- AM2612 Z-Series. 64.99 ea

- Full Sweep Electrical, 2-1/16"**
 Fuel Injected, Includes 1/8" NPT sender and 8' wiring harness.
 Note: Includes isolator & warning.
- AM1763 C2. 239.99 ea
- AM3363 Carbon Fiber. 261.99 ea
- AM6163 Cobalt. 239.99 ea
- AM5963 ES. 239.99 ea
- AM7363 NV. 239.99 ea
- AM5763 Phantom II. 231.99 ea
- AM5663 Phantom II. 214.99 ea
- AM3363 Sport Comp. 231.99 ea

- AM3663 Sport Comp II. 214.99 ea
- AM4663 ES. 231.99 ea
- AM4371 Ultra Lite. 245.99 ea
- AM4963 Ultra Lite II. 214.99 ea
- AM2663 Z-Series. 219.99 ea
- Full Sweep Mechanical, 2-5/8"**
 Fuel Injected, Requires #4 braided line and mounting cup and must be mounted outside of vehicle.
- AM7812 Carbon Fiber. 84.99 ea
- Full Sweep Electrical, 2-5/8"**
 Fuel Injected, Includes 1/8" NPT sender and 8' wiring harness.
 Note: *w/peuk & warning.
- AM4863 Carbon Fiber. 261.99 ea
- AM7063 Cobalt. 255.99 ea
- AM5863 Phantom II. 245.99 ea
- AM7863 Phantom II. 231.99 ea
- AM3363 Sport Comp. 245.99 ea
- AM7663 Sport Comp II. 231.99 ea
- AM4463 Ultra Lite. 235.99 ea
- AM4472 Ultra Lite. 256.99 ea
- AM7763 Ultra Lite II. 231.99 ea

Hour Meter

- Short Sweep Electrical, 2-1/16"**
 Non-rotary w/digital, accuracy for up to 100,000 hrs.
- AM2587 Traditional. 59.99 ea

Nitrous 0-1600 psi

- Full Sweep Mechanical, 2-1/16"**
 Requires #4 braided line.
- AM4812 Carbon Fiber. 125.99 ea
- Full Sweep Electrical, 2-1/16"**
 Includes 1/8" NPT sender and 8' wiring harness.
- AM1714 C2. 239.99 ea
- AM4774 Carbon Fiber. 255.99 ea
- AM6614 Cobalt. 239.99 ea
- AM5974 ES. 239.99 ea
- AM6474 Nexus. 269.99 ea
- AM7374 NV. 299.99 ea
- AM7574 Phantom II. 214.99 ea
- AM3374 Sport Comp. 241.99 ea
- AM3674 Sport Comp II. 214.99 ea
- AM4374 Ultra Lite. 214.99 ea
- AM4974 Ultra Lite II. 214.99 ea

- Full Sweep Electrical, 2-5/8"**
 Includes 1/8" NPT sender and 8' wiring harness.
- AM7074 Cobalt. 255.99 ea
- AM7874 Phantom II. 231.99 ea
- AM3374 Sport Comp. 244.99 ea
- AM5774 Sport Comp. 231.99 ea
- AM4474 Ultra Lite. 256.99 ea
- AM7774 Ultra Lite II. 231.99 ea

Nitrous 0-2000 psi

- Full Sweep Mechanical, 2-1/16"**
 Requires #4 braided line.
- AM5728 Phantom. 101.99 ea
- AM3328 Sport Comp. 99.99 ea
- AM4328 Ultra Lite. 119.99 ea
- Full Sweep Mechanical, 2-5/8"**
 Requires #4 braided line.
- AM4828 Carbon Fiber. 124.99 ea
- AM5828 Phantom. 109.99 ea
- AM4428 Sport Comp. 101.99 ea
- AM4428 Ultra Lite. 119.99 ea

Oil Pressure

- Full Sweep Mechanical, 2-1/16"**
 Includes 1/8" NPT sender, 1/8" and 1/4" NPT fittings. All Oil Pressure gauges measure in PSI.
- AM7121 C2-100 psi. 84.99 ea
- AM4721 Carbon Fiber-100... 74.99 ea

- AM6121 Cobalt-100 85.99 ea
- ES-100 84.99 ea
- AM7321 NV-100 84.99 ea
- AM5721 Phantom-100 64.99 ea
- AM5723 Phantom-100 69.99 ea
- AM7521 Phantom II-100 76.99 ea
- AM3321 Sport Comp-100 61.99 ea
- AM3323 Sport Comp-100 50. 61.99 ea
- AM3322 Sport Comp-100-64.99 ea
- AM3321 Sport Comp-100 76.99 ea
- AM4241 Traditional-100 59.99 ea
- AM2422 Traditional-100 59.99 ea
- AM4321 Ultra Lite-100 69.99 ea
- AM4323 Ultra Lite-100 65.99 ea
- AM4422 Ultra Lite-200 65.99 ea
- AM4421 Ultra Lite II-100 76.99 ea
- AM4624 Z-Series-100 56.99 ea
- AM4605 Z-Series-200 59.99 ea

Full Sweep Electrical, 2-1/16"

- Includes 1/8" NPT sender and 8' wiring harness.
 Note: *w/peuk & warning.
- AM7153 C2-100 psi. 239.99 ea
- AM6153 Cobalt-100 239.99 ea
- AM5953 ES-100 239.99 ea
- AM6453 Ultra Lite-100 269.99 ea
- AM7353 NV-100 239.99 ea
- AM7553 Phantom II-100 214.99 ea
- AM3653 Sport Comp-100 214.99 ea
- AM4353 Ultra Lite-100 235.99 ea
- AM4653 Ultra Lite-100 256.99 ea
- AM4953 Ultra Lite II-100 214.99 ea

- Full Sweep Mechanical, 2-5/8"**
 Includes 1/8" nylon tubing, 1/8" and 1/4" NPT fittings.
- AM4821 Carbon Fiber-100 psi 84.99 ea
- AM7921 Cobalt-100 94.99 ea
- AM5821 Phantom-100 64.99 ea
- AM5823 Phantom-100 74.99 ea
- AM5822 Phantom-100 69.99 ea
- AM821 Phantom II-100 84.99 ea
- AM3421 Sport Comp-100 64.99 ea
- AM3423 Sport Comp-100 65.99 ea
- AM3422 Sport Comp-100 65.99 ea
- AM7621 Sport Comp II-100 84.99 ea
- AM4421 Ultra Lite-100 74.99 ea
- AM4423 Ultra Lite-100 74.99 ea
- AM4422 Ultra Lite-100 74.99 ea
- AM7721 Ultra Lite II-100 84.99 ea

- Full Sweep Electrical, 2-5/8"**
 Includes 1/8" NPT sender and 8' wiring harness.
 Note: *w/peuk & warning.
- AM7953 Cobalt-100 psi. 255.99 ea
- AM7853 Phantom II-100 231.99 ea
- AM7653 Sport Comp II-100 231.99 ea
- AM4443 Ultra Lite-100 224.99 ea
- AM4543 Ultra Lite-100 259.99 ea
- AM7753 Ultra Lite II-100 231.99 ea

- Short Sweep Electrical, 2-1/16"**
 Includes 1/8" NPT sender and 1/4" NPT fittings.
- AM1226 Amer. Musc-100 psi 104.99 ea
- AM7127 C2-100 109.99 ea
- AM4727 Carbon Fiber-100... 89.99 ea
- AM6627 Cobalt-100 109.99 ea
- AM5927 ES-100 109.99 ea
- AM7327 NV-100 84.99 ea
- AM7527 MCX-100 psi 109.99 ea
- AM5727 Phantom-100 79.99 ea
- AM7527 Phantom II-100 96.99 ea
- AM3327 Sport Comp-100 79.99 ea
- AM3627 Sport Comp II-100 96.99 ea

Performance Gauges



Phantom



Phantom II



Sport-Comp



Sport-Comp II



Traditional Chrome

AM2522 Traditional, 0-100... 71.99 ea
 AM4327 Ultra Lite, 0-100... 84.99 ea
 AM4927 Ultra Lite II, 0-100... 96.99 ea
 AM2634 Z-Series, 0-100... 72.99 ea
Short Sweep Electrical, 2-5/8"
Includes 1/8" NPT sender and 14" NPT fitting.
 AM4827 Carbon Fiber, 140°-280°... 105.99 ea
 AM7927 Cobalt, 0-100... 115.99 ea
 AM5827 Phantom, 0-100... 85.99 ea
 AM7827 Phantom II, 0-100... 104.99 ea
 AM3522 Sport Comp, 0-100... 81.99 ea
 AM7627 Sport Comp II, 0-100... 104.99 ea
 AM4427 Ultra Lite, 0-100... 94.99 ea
 AM7727 Ultra Lite II, 0-100... 104.99 ea

Oil Tank Temperature
Full Sweep Mechanical, 2-1/16"
Includes 4" capillary tubing and 1/2" NPT fitting. All Oil Tank Temp gauges measure in °F.
 AM4346 Ultra Lite, 140°-340°... 95.99 ea

Oil Temperature
Full Sweep Mechanical, 2-1/16"
Includes 6" capillary tubing and 1/2" NPT fitting. All Oil Temp gauges measure in °F.
 AM4741 Phantom, Carbon Fiber, 140°-280°... 109.99 ea
 AM5741 Phantom, 140°-280°... 89.99 ea
 AM3341 Sport Comp, 140°-280°... 89.99 ea
 AM4241 Traditional, 140°-280°... 84.99 ea
 AM4341 Ultra Lite, 140°-280°... 89.99 ea
 AM2609 Z-Series, 140°-280°... 85.99 ea

Full Sweep Electrical, 2-1/16"
Includes 1/8" NPT sender, 3/8" and 1/2" NPT fittings and 8" wiring harness.
 Note: *w/epak & warning.
 AM1756 C2, 140°-280°... 179.99 ea
 AM6156 Cobalt, 140°-280°... 179.99 ea
 AM5956 ES, 140°-280°... 179.99 ea
 AM7356 NV, 140°-280°... 179.99 ea
 AM7556 Phantom II, 140°-280°... 161.99 ea
 AM3656 Sport Comp II, 140°-280°... 161.99 ea
 AM4356 Ultra Lite, 100°-340°... 186.99 ea
AM4340 Ultra Lite, 100°-340°... 205.99 ea
 AM4956 Ultra Lite II, 100°-340°... 161.99 ea

Full Sweep Mechanical, 2-5/8"
*Includes 6" capillary tubing and 1/2" NPT fitting. Note: *includes 12" capillary tubing.*
 AM4841 Carbon Fiber, 140°-280°... 119.99 ea
 AM7941 Cobalt, 140°-280°... 129.99 ea
 AM5841 Phantom, 140°-280°... 101.99 ea
 AM7841 Phantom II, 140°-280°... 116.99 ea
 AM3441 Sport Comp, 140°-280°... 94.99 ea
 AM3443 Sport Comp II, 140°-280°... 99.99 ea
 AM7641 Sport Comp II, 140°-280°... 116.99 ea
 AM4441 Ultra Lite, 140°-280°... 111.99 ea
 AM7741 Ultra Lite II, 140°-280°... 119.99 ea

Full Sweep Electrical, 2-5/8"
Includes 1/8" NPT sender, 3/8" and 1/2" NPT fittings and 8" wiring harness.
 Note: *w/epak & warning.
 AM7956 Cobalt, 140°-340°... 195.99 ea
 AM7856 Sport Comp II, 140°-300°... 175.99 ea
 AM7656 Phantom II, 140°-300°... 175.99 ea
 AM4456 Ultra Lite, 140°-300°... 194.99 ea
 AM4440 Ultra Lite, 140°-300°... 171.99 ea
 AM7756 Ultra Lite II, 140°-300°... 215.99 ea
Short Sweep Electrical, 2-1/16"
Includes 1/8" NPT sender and 12" NPT fitting.

AM1748 C2, 140°-300°... 85.99 ea
 AM4748 Carbon Fiber, 140°-300°... 74.99 ea
 AM6148 Cobalt, 140°-300°... 85.99 ea
 AM5948 ES, 140°-300°... 85.99 ea
 AM7348 NV, 140°-300°... 85.99 ea
 AM5747 Phantom, 100°-250°... 64.99 ea
 AM5748 Phantom II, 140°-300°... 74.99 ea

AM3347 Sport Comp, 100°-250°... 59.99 ea
 AM3348 Sport Comp II, 140°-300°... 59.99 ea
 AM3648 Sport Comp II, 140°-300°... 79.99 ea
 AM2542 Traditional, 100°-250°... 56.99 ea
 AM2543 Traditional, 140°-300°... 56.99 ea
 AM4347 Ultra Lite, 100°-250°... 65.99 ea
 AM4348 Ultra Lite, 140°-300°... 64.99 ea
 AM4948 Ultra Lite II, 140°-300°... 79.99 ea
 AM2638 Z-Series, 100°-250°... 54.99 ea
 AM2639 Z-Series, 140°-300°... 54.99 ea
Short Sweep Electrical, 2-5/8"
Includes 1/8" NPT sender, 3/8" and 1/2" NPT fittings.

AM4848 Carbon Fiber, 140°-300°... 89.99 ea
 AM7948 Cobalt, 140°-300°... 99.99 ea
 AM5847 Phantom, 100°-250°... 74.99 ea
 AM7848 Phantom II, 140°-300°... 89.99 ea
 AM3542 Sport Comp, 100°-250°... 71.99 ea
 AM2543 Sport Comp, 140°-300°... 69.99 ea
 AM7648 Sport Comp II, 140°-300°... 89.99 ea
 AM4447 Ultra Lite, 140°-300°... 79.99 ea
 AM7748 Ultra Lite II, 140°-300°... 89.99 ea

Pressure 0-400 psi
Full Sweep Mechanical, 2-5/8"
Requires #8 braided line. All Oil Tank Temp gauges measure in °F.
 AM4424 Ultra Lite... 79.99 ea

Pyrometer
Full Sweep Electrical, 2-1/16"
Includes probe and 10' of thermocouple wire. Probe includes multiple mounting options, including 1/8" NPT and weld-in fitting and hose clamp method.
 AM4742 C2, 0°-1600°... 195.99 ea
 AM7145 C2, 0°-2000°... 205.99 ea
 AM4744 Carbon Fiber, 0°-1600°... 194.99 ea
 AM6144 Cobalt, 0°-1600°... 205.99 ea
 AM6145 Cobalt, 0°-2000°... 205.99 ea
 AM5944 ES, 0°-1600°... 205.99 ea
 AM5945 ES, 0°-2000°... 205.99 ea
 AM7344 NV, 0°-1600°... 205.99 ea
 AM7345 NV, 0°-2000°... 205.99 ea
 AM5744 Phantom, 0°-1600°... 74.99 ea
 AM5745 Phantom, 0°-2000°... 74.99 ea
 AM7544 Phantom II, 0°-1600°... 195.99 ea
 AM7545 Phantom II, 0°-2000°... 205.99 ea
 AM3344 Sport Comp, 0°-1600°... 175.99 ea
 AM3344 Sport Comp II, 0°-1600°... 205.99 ea
 AM3645 Sport Comp II, 0°-2000°... 205.99 ea
 AM4344 Ultra Lite, 0°-1600°... 174.99 ea
 AM4345 Ultra Lite, 0°-2000°... 181.99 ea
 AM4944 Ultra Lite II, 0°-1600°... 205.99 ea
 AM4945 Ultra Lite II, 0°-2000°... 205.99 ea

AM2654 Z-Series, 0°-1600°... 176.99 ea
Full Sweep Electrical, 2-5/8"
Includes probe and 10' of thermocouple wire. Probe includes multiple mounting options, including 1/8" NPT and weld-in fitting and hose clamp method.
 AM4443 Ultra Lite, 0°-1600°... 129.99 ea

Temperature
Full Sweep Mechanical, 2-5/8"
Includes 8" capillary tubing and 1/2" NPT fitting. Temperature gauges measure in °F.
 AM4435 Ultra Lite 140°-340°... 114.99 ea

Trans Temperature
Trans Temp gauges measure in °F.
Full Sweep Mechanical, 2-1/16"
Includes 1/8" NPT sender, 3/8" and 1/2" NPT fittings.

AM3351 Ultra Lite, 140°-280°... 94.99 ea
 AM2451 Traditional, 140°-280°... 89.99 ea
 AM3351 Sport Comp, 140°-280°... 94.99 ea
 AM2615 Z-Series, 140°-280°... 84.99 ea

Full Sweep Electrical, 2-1/16"
Includes 1/8" NPT sender and 1/2" NPT fittings.
 AM1757 C2, 100°-260°... 179.99 ea
 AM6157 Cobalt 100°-260°... 179.99 ea
 AM5957 ES, 100°-260°... 179.99 ea
 AM3757 NV, 100°-260°... 179.99 ea
 AM7557 Phantom II, 100°-260°... 161.99 ea
 AM3657 Sport Comp II, 100°-260°... 161.99 ea
 AM4957 Ultra Lite II, 100°-260°... 161.99 ea

Full Sweep Mechanical, 2-5/8"
Includes 6" capillary tubing and 1/2" NPT fitting.
 AM4851 Carbon Fiber, 140°-280°... 124.99 ea
 AM5851 Phantom, 140°-280°... 106.99 ea
 AM3451 Sport Comp, 140°-280°... 94.99 ea
 AM4451 Ultra Lite, 140°-280°... 114.99 ea

Short Sweep Electrical, 2-1/16"
Includes 1/8" NPT sender, 3/8" and 1/2" NPT fittings.
 AM1749 C2, 100°-250°... 86.99 ea
 AM7357 Carbon Fiber, 100°-280°... 74.99 ea
 AM6149 Cobalt, 100°-250°... 89.99 ea
 AM5949 ES, 100°-250°... 86.99 ea
 AM7349 NV, 100°-250°... 86.99 ea
 AM3757 Phantom II, 100°-250°... 64.99 ea
 AM7549 Phantom II, 100°-250°... 79.99 ea
 AM3357 Sport Comp, 100°-250°... 59.99 ea
 AM3649 Sport Comp II, 100°-250°... 79.99 ea
 AM2552 Traditional, 100°-250°... 55.99 ea
 AM4157 Ultra Lite, 100°-250°... 69.99 ea
 AM4949 Ultra Lite II, 100°-250°... 79.99 ea
 AM2640 Z-Series, 100°-250°... 54.99 ea

Short Sweep Electrical, 2-5/8"
Includes 1/8" NPT sender, 3/8" and 1/2" NPT fittings.
 AM7957 Cobalt, 100°-250°... 99.99 ea
 AM5857 Phantom, 100°-250°... 71.99 ea
 AM7857 Phantom II, 100°-250°... 89.99 ea
 AM3352 Sport Comp, 100°-250°... 75.99 ea
 AM7657 Sport Comp II, 100°-250°... 89.99 ea
 AM4457 Ultra Lite, 100°-250°... 79.99 ea
 AM7757 Ultra Lite II, 100°-250°... 89.99 ea

Vacuum 30 in Hg
Full Sweep Mechanical, 2-1/16"
Includes 10' ion tubing and 1" fitting.
 AM4784 Carbon Fiber... 76.99 ea
 AM7844 Phantom... 69.99 ea
 AM3384 Sport Comp... 64.99 ea
 AM2784 Traditional... 69.99 ea
 AM4384 Ultra Lite... 65.99 ea
 AM2610 Z-Series... 61.99 ea

Full Sweep Mechanical, 2-5/8"
Includes 10' nylon tubing and universal "T" fitting.
 AM4884 Carbon Fiber... 84.99 ea
 AM7948 Cobalt... 99.99 ea
 AM5884 Phantom... 69.99 ea
 AM7884 Phantom II... 89.99 ea
 AM3384 Sport Comp... 64.99 ea
 AM7684 Sport Comp II... 89.99 ea
 AM4484 Ultra Lite... 79.99 ea
 AM7784 Ultra Lite II... 89.99 ea

Full Sweep Electrical, 2-5/8"
Includes 10' nylon universal "T" fitting and 8" wiring harness.
 AM4871 Carbon Fiber... 231.99 ea

Digital Voltmeter 8-19 Volts
Includes 10' ion tubing and 1" fitting.
 AM6391 Cobalt... 136.99 ea

Voltmeter 8-18 Volts
Full Sweep Electrical, 2-1/16"
*Note: *w/epak & warning.*
 AM7191 C2... 139.99 ea
 AM6391 Cobalt... 139.99 ea
 AM5991 ES... 139.99 ea
 AM7991 Phantom II... 131.99 ea
 AM3691 Sport Comp II... 131.99 ea

Note: All Auto Meter gauges are discount exempt.

AM4383³ Ultra Lite... 154.99 ea
 AM4991 Ultra Lite II... 131.99 ea
Full Sweep Electrical, 2-5/8"
*Note: *w/epak & warning.*
 AM4483³ Ultra Lite... 155.99 ea
Short Sweep Electrical, 2-1/16"
 AM1258 Amer. Meter... 81.99 ea
 AM7192 C2... 75.99 ea
 AM4791 Carbon Fiber... 64.99 ea
 AM6192 Cobalt... 75.99 ea
 AM5992 ES... 75.99 ea
 AM1192 MCX... 59.99 ea
 AM7302 NV... 75.99 ea
 AM5791 Phantom II... 54.99 ea
 AM7902 Phantom II... 69.99 ea
 AM3391 Sport Comp... 51.99 ea
 AM3691 Sport Comp II... 69.99 ea
 AM2592 Traditional... 49.99 ea
 AM4391 Ultra Lite... 54.99 ea
 AM4992 Ultra Lite II... 69.99 ea

AM2645 Z-Series... 74.99 ea
Short Sweep Electrical, 2-5/8"
 AM4891 Carbon Fiber... 44.99 ea
 AM7991 Cobalt... 89.99 ea
 AM5891 Phantom... 55.99 ea
 AM7891 Phantom II... 76.99 ea
 AM3392 Sport Comp... 61.99 ea
 AM7691 Sport Comp II... 76.99 ea
 AM4491 Ultra Lite... 64.99 ea
 AM7791 Ultra Lite II... 76.99 ea

Water Pressure
Full Sweep Mechanical, 2-1/16"
Note: Includes 10' nylon tubing, 1/8" and 1/4" NPT fittings.
 AM4307 Ultra Lite, 0-35 PSI... 69.99 ea
Full Sweep Electrical, 2-1/16"
Note: Includes 1/8" NPT sender and 8" wiring harness.
 Note: *w/epak & warning.
 AM4368³ Ultra Lite, 0-100 PSI... 255.99 ea
Full Sweep Mechanical, 2-5/8"
Note: Includes 10' nylon tubing, 1/8" and 1/4" NPT fittings.
 AM4407 Ultra Lite, 0-35 PSI... 84.99 ea

Fuel Tank Sender
 This universal type fuel sender is used with gauges that require 24042 empty and 3343 full and can be adjusted for tanks from 5" to 24" deep.
 Note: No further discounts apply.
 AM3262... 36.99 ea

Speedometer Sending Unit
 Speedometer sending unit for use with Auto Meter electric speedometer.
 This unit is not included with the gauge packages and must be purchased separately.
 AM5291... 69.99 ea



Performance Gauges



Note: All Auto Meter gauges are discount exempt.

Water Temperature

Full Sweep Mechanical, 2-1/16"

Includes 6 capillary tubing and 1/20" NPT fitting. All Water Temp gauges measure in °F.

Note: *Includes 12' of capillary tubing.

AM7132	C2, 120°-240°	119.99 ea
AM7131	C2, 140°-280°	119.99 ea
AM4732	Carbon Fiber, 120°-240°	104.99 ea
AM4731	Carbon Fiber, 140°-280°	101.99 ea
AM6132	Cobalt, 120°-240°	119.99 ea
AM6131	Cobalt, 140°-280°	119.99 ea
AM5932	ES, 120°-240°	119.99 ea
AM5931	ES, 140°-280°	119.99 ea
AM7332	NV 120°-240°	119.99 ea
AM7331	NV 140°-280°	119.99 ea
AM5732	Phantom II, 120°-240°	89.99 ea
AM5731	Phantom II, 140°-280°	86.99 ea
AM7532	Phantom II, 120°-240°	105.99 ea
AM7531	Phantom II, 140°-280°	105.99 ea
AM3332	Sport Comp, 120°-240°	86.99 ea
AM3331	Sport Comp, 120°-240°	96.99 ea
AM3331	Sport Comp, 140°-280°	89.99 ea
AM3632	Sport Comp II, 120°-240°	105.99 ea
AM3631	Sport Comp II, 140°-280°	105.99 ea
AM2432	Traditional, 120°-240°	84.99 ea
AM2431	Traditional, 120°-240°	91.99 ea
AM4331	Traditional, 140°-280°	81.99 ea
AM4332	Ultra Lite, 120°-240°	89.99 ea
AM4331	Ultra Lite, 120°-240°	101.99 ea
AM4331	Ultra Lite, 140°-280°	86.99 ea
AM4932	Ultra Lite II, 120°-240°	105.99 ea
AM4931	Ultra Lite II, 140°-280°	105.99 ea
AM2607	Z-Series, 120°-240°	83.99 ea
AM2606	Z-Series, 140°-280°	81.99 ea

Full Sweep Electrical, 2-1/16"

AM4369 includes 1/8" NPT sender and 1/2" NPT fittings and 8' wiring harness. AM4355 includes 1/8" NPT sender, 1/2" NPT fittings and 8' wiring harness.

Note: *w/peak & warning.

AM7155	C2, 100°-260°	179.99 ea
AM8155	Cobalt, 100°-260°	179.99 ea
AM5955	ES, 100°-260°	179.99 ea
AM7355	NV, 100°-260°	179.99 ea
AM7555	Phantom II, 100°-260°	161.99 ea
AM6555	Sport Comp II, 100°-260°	161.99 ea
AM4369	Ultra Lite, 140°-210°	185.99 ea
AM4355	Ultra Lite, 100°-260°	185.99 ea
AM4354*	Ultra Lite, 100°-260°	204.99 ea
AM4955	Ultra Lite II, 100°-260°	161.99 ea

Full Sweep Mechanical, 2-5/8"

Include 6 capillary tubing & 1/2" NPT fitting.

Note: *Includes 12' of capillary tubing.

AM4832	Carbon Fiber, 120°-240°	124.99 ea
AM4831	Carbon Fiber, 140°-280°	124.99 ea
AM7932	Cobalt, 120°-240°	129.99 ea
AM7931	Cobalt, 140°-280°	129.99 ea
AM5832	Phantom, 120°-240°	104.99 ea
AM5831	Phantom, 140°-280°	101.99 ea
AM7832	Phantom II, 120°-240°	116.99 ea
AM7831	Phantom II, 140°-280°	116.99 ea
AM4342	Sport Comp, 120°-240°	89.99 ea
AM4343*	Sport Comp, 120°-240°	101.99 ea
AM4341	Sport Comp, 140°-280°	89.99 ea
AM7632	Sport Comp II, 120°-240°	116.99 ea
AM7631	Sport Comp II, 140°-280°	116.99 ea
AM4342	Ultra Lite, 120°-240°	114.99 ea
AM4343*	Ultra Lite, 120°-240°	119.99 ea
AM4431	Ultra Lite, 140°-280°	105.99 ea
AM7732	Ultra Lite II, 120°-240°	116.99 ea
AM7731	Ultra Lite II, 140°-280°	116.99 ea

Full Sweep Electrical, 2-5/8"

Includes 1/8" NPT sender, 3/8" & 1/2" NPT fittings & 8' wiring harness. Note: *w/peak & warning.

AM7955	Cobalt, 100°-260°	195.99 ea
AM7855	Phantom II, 100°-260°	175.99 ea
AM3569	Sport Comp, 60°-210°	174.99 ea
AM7655	Sport Comp II, 100°-260°	175.99 ea
AM4469	Ultra Lite, 60°-210°	185.99 ea
AM4455	Ultra Lite, 100°-260°	185.99 ea
AM4454*	Ultra Lite, 100°-260°	214.99 ea
AM7755	Ultra Lite II, 100°-260°	175.99 ea

Short Sweep Electrical, 2-1/16"

Note: *w/peak & warning.

AM1236	Aner. Mose, 100°-250°	94.99 ea
AM1737	C2, 100°-250°	84.99 ea
AM4737	Carbon Fiber, 100°-250°	74.99 ea
AM6137	Cobalt, 100°-250°	85.99 ea
AM5937	ES, 100°-250°	84.99 ea
AM1137	MCX, 100°-260°	71.99 ea
AM7337	NV, 100°-250°	84.99 ea
AM5737	Phantom, 100°-250°	64.99 ea
AM4757	Phantom II, 100°-250°	76.99 ea
AM3337	Sport Comp, 100°-250°	61.99 ea
AM4367	Sport Comp II, 100°-250°	76.99 ea
AM2532	Traditional, 100°-250°	59.99 ea
AM4337	Ultra Lite, 100°-250°	64.99 ea
AM4937	Ultra Lite II, 100°-250°	76.99 ea
AM2635	Z-Series, 100°-250°	55.99 ea

Short Sweep Electrical, 2-5/8"

AM4837	Carbon Fiber, 100°-250°	89.99 ea
AM7937	Cobalt, 100°-250°	99.99 ea
AM5837	Phantom, 100°-250°	79.99 ea
AM4737	Phantom II, 100°-250°	89.99 ea
AM3531	Sport Comp, 100°-250°	69.99 ea
AM7637	Sport Comp II, 100°-250°	89.99 ea
AM4437	Ultra Lite, 100°-250°	74.99 ea
AM7737	Ultra Lite II, 100°-250°	89.99 ea



Note: All Auto Meter tachometers are discount exempt.

2-5/8" Pedestal Tachometers

6,000 RPM		
AM2891	Z-Series	114.99 ea
8,000 RPM		
AM3708	Sport Comp	129.99 ea
AM3707	Ultra Lite	135.99 ea

3-3/4" Pedestal Tachometers

8,000 RPM		
AM5780	Phantom	171.99 ea
AM3780	Sport Comp	151.99 ea
AM2895	Traditional	151.99 ea
AM3781	Ultra Lite	184.99 ea
AM2894	Z-Series	132.99 ea
8,000 RPM Short Sweep		
AM2897	Traditional	164.99 ea

Note: *w/revnote motor switch

AM3700	Sport Comp	164.99 ea
AM6604*	Ultra Lite w/recall	324.99 ea
10,000 RPM Mini Monster		
AM7290	C2	271.99 ea
AM6290	Cobalt	274.99 ea
AM5990	ES	281.99 ea
AM7390	NV	271.99 ea

AM7900	Phantom II	219.99 ea
AM6690	Sport Comp II	215.99 ea
AM6900	Ultra Lite II	215.99 ea

5" Pedestal Tachometers

8,000 RPM		
AM3980	Sport Comp	184.99 ea
8,000 RPM, External Shift Light		
AM3905	Sport Comp	269.99 ea
9,000 RPM, Memory, Two Stage, Shift Light, Dual Range		
AM6854	Ultra Lite	356.99 ea
9,000 RPM, Playback ProComp		
AM5798	Phantom	499.99 ea
9,000 RPM, Memory, Two Stage, Shift Light, Single Range		
AM6856	Ultra Lite	359.99 ea
9,000 RPM, w/4 Stage Light & Recall		
AM6835	Carbon Fiber	491.99 ea
AM6832	Ultra Lite	491.99 ea
10,000 RPM, Memory & 2 Stage External Shiftlight		
AM3906	Sport Comp	374.99 ea
10,000 RPM, External Shiftlight		
AM7299	C2	299.99 ea
AM4899	Carbon Fiber	309.99 ea

AM6299	Cobalt	209.99 ea
AM5999	ES	209.99 ea
AM7499	NV	295.99 ea
AM5899	Phantom	285.99 ea
AM7599	Phantom II	251.99 ea
AM3904	Sport Comp	269.99 ea
AM3699	Sport Comp II	251.99 ea
AM2911	Ultra Lite	281.99 ea
AM4999	Ultra Lite II	251.99 ea
10,000 RPM, Memory		
AM5795	Phantom	204.99 ea
10,000 RPM		
AM3900	Sport Comp	179.99 ea
AM3910	Ultra Lite	195.99 ea
10,000 RPM, Dial Shiftlight		
AM3903	Sport Comp	254.99 ea
11,000 RPM, w/4 Stage Light & Recall		
AM6836	Carbon Fiber	491.99 ea
AM6834	Ultra Lite	491.99 ea
11,000 RPM, Memory, Two Stage Shiftlight & Single Range		
AM6858	Ultra Lite	356.99 ea
11,000 RPM, Memory, Two Stage Shiftlight & Dual Range		
AM6855	Ultra Lite	356.99 ea

E DASH & CONSOLE COMPONENTS

Gauge Accessories



LED Replacement Bulbs

Upgrade your standard instrument lighting with intense LEDs. For all Auto Meter gauges (except clocks, A/F ratio, & Autogage), speedometers and tachometers. Does not work with Digital & LED Lit Gauges (i.e. Cobalt, C2, NV, Phantom II, Sport-Comp II, Ultra-Lite II). Sold individually.

Note: No further discounts apply.

Tachometers - Twist-In Bulb

AM3295	green	14.99 ea
AM3294	red	12.99 ea
AM3296	blue	14.99 ea
AM3297	amber	12.99 ea

All Other Gauges - Wedge-Base Bulb

AM3285	green	15.99 ea
AM3284	red	11.99 ea
AM3286	blue	15.99 ea
AM3287	amber	12.99 ea



Light Bulb Covers

For optional lighting color on most gauges. Does not work with digital & LED lit gauges (i.e. Cobalt, C2, NV, Phantom II, Sport-Comp II, Ultra-Lite II). Set of 3.

Note: No further discounts apply.

AM3215	green	7.99 set
AM3214	red	7.99 set
AM3207	blue	9.99 set
AM3208	yellow	9.99 set



MCX Series In-Dash Gauges

Features a domed lens, bright white dial face, black numbering and increments and fluorescent red pointers and a chrome Super Bezel. When lit for night time use, the gauges display "full dial" white illumination provided by patented LED lighting technology. The light intensity can be controlled through the optional LED Lighting Dimmer independently from your OE dash lighting (available separately).

Important: Electric speedometers operate on 500-200,000 pulse/inch sending units. Use existing sender if vehicle is originally equipped with an electric speedometer. Use AM3291 to convert from mechanical drive to electric. Tachometers operate on 4, 6, or 8 cylinder engines with most factory or aftermarket ignitions. Some fuel gauges use the vehicle's stock sending unit. Measure resistance using an ohmmeter with the sending unit float in the empty and full position to determine the correct fuel gauge.

Note: No further discounts apply.

Electric Programmable Speed & Tach Combo 5"		
AM1190	120 MPH/8,000 RPM	429.99 ea
Electric Quad Gauge Combo 5"		
AM1110	fuel/oil/water/volt	279.99 ea



Distributorless Tach Adapter

This tachadapter is designed to adapt a standard ignition tachometer. Pro Shift light, or RPM activated module to be used with distributorless ignition systems.

Note: For use with distributorless ignition systems only. No further discounts apply.

AM9117	tach adapter	96.99 ea
--------	--------------	----------



LED Lighting Dimmer

This compact separate module is designed to allow for isolated dimming for all Auto Meter gauges utilizing LED lighting technology separate from your vehicle's OEM dash.

Note: No further discounts apply.

AM9114	LED Dimmer	34.99 ea
--------	------------	----------



Universal Gauge Harness

If you want to keep your under-dash area organized or you think that you need to remove gauges from time to time then you need to install our universal gauge harness. It will connect all major brand gauges including Auto Meter and VDO and works with most dash layouts and sizes.

Note: No further discounts apply.

Universal Gauge Harness		
30301	for cable driven speedometer	132.99 ea
30302	for electric speedometer	132.99 ea
1 1/8" Indicator Lamps		
80200	amber	12.99 ea
80201	red	12.99 ea
80202	green	12.99 ea
5/16" Indicator Lamps		
80203	amber	11.99 ea
80204	red	11.99 ea
80205	green	11.99 ea
80206	blue	11.99 ea
1 1/2" Indicator Lamps		
80208	amber	16.99 ea
80209	red	16.99 ea
80210	green	16.99 ea
80211	blue	16.99 ea



AM5334



AM5335

Shift-Lite

Uses an incandescent bulb and bright amber lens to alert the driver to preset shift points. Available in black or silver. Includes cover. Use with external, non-LED based, shift light tachometers or DPSS Controller sold separately.

Note: No further discounts apply.

AM5334	black	54.99 ea
AM5335	silver	54.99 ea



AM5330



AM5331

Quick-Lite Shift-Lites

Ultra-Fast response, vibration resistant amber LED light. Compatible with all external shift light tachometers and DPSS Controllers sold separately.

Note: No further discounts apply.

AM5330	black	59.99 ea
AM5331	silver	61.99 ea
AM5329	chrome	84.99 ea



AM5332

Super-Lite 12 LED Shift-Lite

A brighter LED illuminated version of the Shift-Lite. This light uses 12 bright amber LEDs and features a three position brightness switch. Available in black or silver. Use with external, non-LED based, shift light tachometers or DPSS Controller sold separately.

Note: No further discounts apply.

AM5332	black	86.99 ea
AM5333	silver	89.99 ea

In-Dash Audio



MB2089



MB2091

1968-69 Plymouth B-Body 100 Watt Radio

Available with a black or chrome face plate with 100 watts, these radios have outstanding features. These features are: manual tuning, 4 way fader, preset scan/seek, pre amp outs, separate bass and treble controls, green back light, 5-AM/15-FM presets, power antenna, digital clock, 3.5mm front auxiliary input and rear USB input.

MB2089 1968-69 chrome.....209.99 ea
MB2091 1968-69 black.....209.99 ea



MB2093



MB2094

1968-69 Plymouth B-Body AM/FM Radio

Replace your original radio with an iPod ready AM/FM radio. With 200 watts this radio has outstanding features. These features are: left/right balance control, seek auto-tune, 4-AM/12-FM presets, power antenna, separate bass and treble controls, front/rear auxiliary input, pre amp outs, digital clock, manual tuning, front/rear fader control.

MB2093 1968-69 chrome.....239.99 ea
MB2094 1968-69 black.....239.99 ea



1968-69 Plymouth B-Body CD Player

With 200 watts this radio has outstanding features including a cd changer controller, random and repeat play, rear pre-outs, plays cd/cd-r/cd-rw/mp3, bass/mid/treble tone controls, automatic memory entry, detachable face, remote control, loudness control, front/rear fader, 24 presets, Mosfet power amplifier, digital clock, seek tuning, auxiliary input.

MB2097 1968-69.....229.99 ea



MB2096

- Auto-Tune Seeking
- 12 FM/4 AM Presets
- Power Antenna Controls
- Bass and Treble controls
- 200 watts of power
- Front/rear auxiliary output

1970 B-Body AM/FM Radio

Replace your original radio with an iPod ready AM/FM radio. With 200 watts this radio has outstanding features. These features are: seek auto-tune, 4-AM/12-FM presets, power antenna, separate bass and treble controls, front/rear fader control, front/rear auxiliary input, digital clock, manual tuning, left/right balance control, pre amp outs.

Note: Must reuse original bezel.
MB2095 1970 chrome.....239.99 ea
MB2096 1970 black.....239.99 ea



CR601

- Wireless Control Up To 40'
- 200 watts 4x50
- USB MP3/WMA Flash Drive Player
- iPod® Interface with 7' Docking Cable
- Alpha Numeric LCD Display Shows Artist/Titles
- Satellite Radio Input
- Auxiliary Audio Input
- 4 Channel 3 Volt RCA Pre-Outs
- Subwoofer Pre-Out
- Electronic Volume, Bass, Treble, Balance, Fader
- 5 Selectable IEQ Curves
- 24 Station Pre-sets (18FM / 6AM)
- Blue LED Illumination

SecretAudio Sound Systems

SecretAudio systems are an excellent choice for any project vehicle because they allow you to keep your original radio intact, or you can hide your audio system altogether! The tuner/amp unit can be hidden out of sight and controlled by either the LCD Display/Controller or a mounted LCD panel with a RF remote control. Both systems boast excellent audio features which make them an ideal choice for any street rod, classic, or custom.

Note: *No further discounts apply.

Secret Audio w/LCD Display/Remote

All system functions are controlled by and shown on the rechargeable remote controller/LCD. Includes LCD holder (usage is optional) and cigarette lighter adapter for charging.

CR601 radio only.....399.99 set

Secret Audio w/Compact RF Remote

Features an LCD display that can be mounted virtually anywhere and controlled by the compact radio-frequency (RF) remote. Includes flush-mount bezel and mounting bracket for your choice of LCD display mounting.

SI02 radio only.....299.99 set

New!



AR1968



AR704



AR714

- Digital Tuning System
- 180 Watts of Power
- Classic Appearance w/Modern Performance
- RCA Inputs for MP3 and Media Inputs
- Two Microprocessor Controllers

1968-74 Modern Reproductions Radios

These radios have the exact look and feel of the originals with the performance you expect from today's technology. Powerful electronics built into a 2-1/2" deep case! Features a proven digital tuner system with a 180 watt RMS amplifier, and RCA inputs for iPod, MP3 or satellite radios. Two powerful microprocessors monitor the knobs and buttons to recreate the original radio operation while providing a clean, modern sound. Includes detailed instruction booklet. Made in USA.

Note: *With Rallye dash. **1968 without Rallye dash.

A-Body

AR1965	1968-69	Dart	694.99 ea
AR1966**	1968-69	Valiant	651.99 ea
AR1967	1968-69	Barracuda	694.99 ea
AR1967*	1970	Swingcar 340	694.99 ea
AR1967*	1970	Duster 340	694.99 ea

B-Body

AR1968	1968	B-Body	649.99 ea
AR1969	1969	B-Body	649.99 ea
AR1970	1970	B-Body	649.99 ea
AR1979**	1970	B-Body	649.99 ea

E-Body

AR704	1970-74	Barracuda	639.99 ea
AR7074	1970-74	Challenger	639.99 ea
AR7174	1971-74	Charger, Coronet	639.99 ea
AR7174	1971-74	Satellite, Belvedere	639.99 ea

New!



Bluetooth® Receiver Adapter

Now you can wirelessly stream audio and take hands-free calls from the road in your Classic Camaro! Simply plug this unit into your cigarette lighter, connect the cable to your radio's 3.5 mm input jack, and pair your Bluetooth® enabled phone or other device... that's it! You'll be ready to wirelessly stream music from your device to your audio system. Calls and music are routed through your car's speakers for excellent sound quality. Includes Bluetooth adapter, 18" extension cable, and instructions.

AR990139.99 ea

In-Dash Audio

Get Cutting Edge Audio & Authentic Retro-Styling with the New Redondo Radio!



RK6367



RK6770

- Your Choice Of Knob Style Or Distinctive Mopar Thumb Roller Controls
- Made-For-iPod®
- Built-In Bluetooth® for Hands-Free Operation
- Push Button Styling For An Authentic Look
- 32,000 Color Illumination
- 24 Watts x 4 RMS / 45 Watts x 4 Power Output
- Two USB Inputs for iPod® or Flash Drive
- Two Auxiliary Inputs For Portable Devices
- Dual RCA Pre-Outs Plus Subwoofer Output
- 3 EQ Presets / Loudness Control
- Separate Power Antenna and Amp Leads

1963-70 RetroSound Redondo Radios

The new RetroSound® Redondo radio is the only radio made specifically for late 1960's to early 1970's Mopar vehicles that originally came supplied with the distinctive "thumb-roller" radio controls and the two knob style. The Redondo display face and push-buttons are independently adjustable, making it easy to install into any Mopar vehicle in which a part of the dash fascia separates the original radio dial from the push-buttons. Now you can enjoy all the modern conveniences with classic Mopar styling.

Knob Style

A-Body	Year	Model	Price
RK6367	1963-67	Dart.....	349.99 ea
RK6367	1964-67	Barracuda.....	349.99 ea
B-Body			
RK6367	1964-67	Fury.....	349.99 ea
RK6367	1966-67	Charger.....	349.99 ea
RK6367	1966-67	Coronet.....	349.99 ea
RK6367	1967	GTX.....	349.99 ea

Thumb Roller Style

A-Body	Year	Model	Price
RR6770	1967-69	Barracuda.....	349.99 ea
RR6770	1967-70	Dart.....	349.99 ea
RR6770	1970	Duster.....	349.99 ea
B-Body			
RR6770	1968-70	Charger.....	349.99 ea
RR6770	1968-70	Coronet.....	349.99 ea
RR6770	1968-70	GTX.....	349.99 ea
RR6770	1968-70	Road Runner.....	349.99 ea
RR6770	1968-70	Satellite.....	349.99 ea
RR6770	1968-70	Belvedere.....	349.99 ea
RR6770	1969	Daytona.....	349.99 ea
RR6770	1970	Super Bee.....	349.99 ea



RT6769C

Includes Authentic Retro-Style Metal Knobs!

- Made-For-iPod®
- Hands-Free Bluetooth Phone Operation
- Stream Wireless Audio From iPhone® or Android®-based Phones
- Authentic Push-Button Styling
- 32,000 Color LCD Illumination
- 24 Watts x 4 RMS / 45 Watts x 4 Power Output
- Dual RCA Pre-Outs + Subwoofer Output
- Four Rear-Mounted Usb Ports For Apple® or Other Mobile Devices

1967-75 RetroSound Model 2 Radios

The new Model Two is the first Apple®-licensed Made-For-iPod® radio for your classic car. Play and charge your iPod®, Touch® or iPhone® through your audio system. The Model Two also has built-in Bluetooth® for hands-free calling as well as wireless audio streaming from any Android® based phone or iPhone®. Featuring push-button styling and a new 32,000 color display, the Model Two looks like the original radio but offers the most modern technology available for your classic ride.

RT6769C	1967-69	chrome.....	329.99 ea
RT6769B	1967-69	black.....	329.99 ea
Plymouth Road Runner			
RT1715C	1971-75	chrome.....	329.99 ea
RT1715B	1971-75	black.....	329.99 ea



RH6769C

Includes Authentic Retro-Style Metal Knobs!

- "Retro" Push Button Styling
- Dual Color (White and Green) LCD
- AM/FM RDS Tuner with 30 Presets
- 2 Rear Auxiliary Inputs For Apple® or Other Portable Devices
- Allows Playback of Mp3 & WMA Files
- 24 W x 4 RMS/45 W x 4 Peak Power Output
- Two Sets of RCA Low Level Outputs
- 3 EQ Presets / Loudness Control

1967-75 RetroSound Zuma Radios

The new Zuma looks like an old-fashioned radio but offers the convenience of modern audio technology. Each radio is designed to fit directly into your factory dash. Includes authentic-looking push buttons, replica knobs, and a trim bezel for a factory looking appearance.

Dodge Dart	Year	Model	Price
RH6769C	1967-69	chrome.....	279.99 kit
RH6769B	1967-69	black.....	279.99 kit
Plymouth Road Runner			
RH7175C	1971-75	chrome.....	279.99 kit
RH7175B	1971-75	black.....	279.99 kit



RC6769B



RC7175C



RC7175B

Includes Authentic Retro-Style Metal Knobs!

- Rear Auxiliary Input
- New 5.37" Mounting Depth
- 18W x 4 RMS Power Amplifier
- AM/FM Tuner with RDS
- LCD Display with Enhanced Viewing Angle

1967-74 Retro Classic AM/FM Radio

The Retro Classic AM/FM radio couples a classic retro appearance with modern electronics and advanced technology to offer you 30 station presets, an auxiliary input front and rear and the exclusive "Infinimount" shaft bracket system which allows you to adjust the radio shafts to fit virtually any OE radio opening. Includes authentic retro-style metal knobs for an original-looking appearance when installed.

Important: Outer faceplate bezel not included.

Dodge Dart

Chrome Bezel			
RC6769C	1967-69	chrome knobs.....	174.99 kit
RC6769B	1967-69	black knobs.....	174.99 kit
Plymouth Road Runner			

Black Bezel			
RC7175C	1971-75	chrome knobs.....	174.99 kit
RC7175B	1971-75	black knobs.....	174.99 kit



SiriusXM Onyx Plus Plug & Play Receiver

Listen to SiriusXM anywhere, anytime. This kit adds satellite radio to any RetroSound radio through the auxiliary input. Includes a built-in FM modulator to interface with any radio with FM stereo and a magnetic mount antenna, aux-in cable and all the mounting accessories you will need. The full color display features album art, channel logos and graphics. You can store up to 20 of your favorite channels for one-touch access, and you can pause, rewind and replay live satellite radio and catch up on the latest sports scores with Sports Tracker. Monthly subscription required. Lock and unlock channels with mature content. A910107 all..... 109.99 ea

In-Dash Audio

New!

CUSTOM
AUTOSOUND



ME1012

- High Power 200 Watts (4 x 50)
- Seek & Scan Tuning
- Electronic tuner
- 4 Way Fader/Front/Rear Left/Right
- Separate Bass and Treble
- 30 Presets (12 AM/18 FM)
- 4 Channel RCA Pre-Out
- Digital Clock
- No Cassette
- Auxiliary Input for Direct Connection to Today's Audio Accessories

Custom Auto Sound USA-230

A great look and sound at an awesome price. This radio has Auxiliary Input for iPod, MP3, Satellite radio etc. Excellent features with a classic look plus 200 watts of power. Includes both chrome and black knobs.
 ME1012 1970 Barracuda..... 159.99 ea
 MB1424 1971-73 Charger..... 159.99 ea
 MB1425 1972 GTX..... 159.99 ea
 MB1426 1971-73 Road Runner..... 159.99 ea

New!

CUSTOM
AUTOSOUND



ME1013

- A Full 300 Watts of Power
- Direct CD Changer Control
- Electronic Volume & Tuning Controls
- 16 Station Presets (4AM/12FM)
- Separate Bass and Treble Controls
- Left/Right Balance
- Front/Rear Fader
- Digital Clock
- Auxiliary RCA Input for Satellite Radio or Portable Players
- 4 Channel RCA Output for Optional Amplifiers

Custom Auto Sound USA-630

This AM/FM radio will control all functions of the optional Custom Autosound 6 disc CD changer from the buttons on the radio. Includes both chrome and black knobs.
Note: No further discounts on kits.



Radio Only			
ME1013	1970	Barracuda.....	239.99 ea
MB1427	1971-73	Charger.....	239.99 ea
MB1428	1972	GTX.....	239.99 ea
MB1429	1971-73	Road Runner.....	239.99 ea
Radio & CD Changer Package			
ME1013C	1970	Barracuda.....	458.99 kit
MB1427C	1971-73	Charger.....	458.99 kit
MB1428C	1972	GTX.....	458.99 kit
MB1429C	1971-73	Road Runner.....	458.99 kit

New!



CU809C



CU809B

Universal Fit Retro-Look CD Player

Since the invention of the CD player, classic car owners have had few options for their classic interior. Not anymore! Say hello to the first CD player with an authentic vintage look. Featuring classic inspired styling with chrome-rimmed dual control knobs and fitted black or chrome display bezel, this CD player is designed to fit "DIN" (approx. 7.2" X 2.11" radio openings (most '84 up models) or vehicles modified for DIN radios (single CD players). Featuring a fold down, fully detachable front panel, these do more than just play CDs- this in-car-entertainment system is equipped with USB/SD/MMC and Aux-In jack interfaces and offers MP3 and WMA playback capability as well as an AM/FM radio. What's more, the extra-large, multi-color screen displays the artist name and song title. The CD/MP3 deck features Electronic Shock protection, 4 x 40 watts of power, 1-pair of RCA pre-outs.
 CU809C chrome..... 166.99 ea
 CU809B black..... 166.99 ea



- 6 Disc Capacity Magazine
- Full Logic CDC Control
- 4 Times Oversampling
- 3 Beam Laser Tracking System
- Anti-Shock Vibration Free Design
- All Functions Controlled By
- Stereo Push-Buttons

Custom Autosound 6 Disc CD Changer

Enjoy the top of the line audio equipment which can be added to the SecretAudio CD controller unit in the audio section. When used in conjunction with these stereo head units, which are designed with the functions in the face of the radio, the UC'D6 CD changer will deliver the highest fidelity and non-skip quality on the market. This unit can be mounted horizontally, vertically or 45° installation.
 UC'D6..... 269.99 ea

New!

AUTHENTIC
RESTORATION



MB1687



MB876

1968-70 B-Body Dash Radio Face Plates

Our new bezels are exact replacements of the originals. Applications are available for a variety of 1968-70 B-Body vehicles.

Radio Delete Plate

MB872	1968	Dodge B-Body.....	99.99 ea
MB875	1968-69	Plymouth B-Body.....	99.99 ea
MB875	1969	Dodge B-Body.....	99.99 ea
MB878	1970	99.99 ea

Standard Radio

MB873	1968	Dodge B-Body.....	99.99 ea
MB876	1968-69	Plymouth B-Body.....	54.99 ea
MB1687	1968-69	Coronet w/wood grain	74.99 ea
MB1687	1968-69	GTX w/wood grain.....	74.99 ea
MB876	1969	Dodge B-Body.....	54.99 ea
MB879	1970	64.99 ea

AM Radio w/8 Track Tape Deck

MB874	1968	Dodge B-Body.....	99.99 ea
MB901	1969	99.99 ea
MN910	1969	w/o 8 track tape player	99.99 ea
MB880	1970	99.99 ea



MB2036



MB16952

1968-74 B & E-Body Radio Parts

Replacement radio parts for 1968-74 B-Body and 1970-74 E-Body vehicles equipped with an original radio. Knob sets include two inner and two outer knobs, push-buttons sold in sets of five.

Radio Knobs

MB2036	1970	B-Body.....	35.99 set
MB2037	1971-74	B & E-Body.....	35.99 set

Radio Push-Buttons

MB16952	1968-70	B-Body.....	82.99 set
ME16281	1970-74	E-Body.....	82.99 set

AUTHENTIC
RESTORATION



ME1452

1970-74 E-Body Dash Speaker Grill

Replace the cracked or broken speaker grill on your 1970-74 E-Body vehicle with a brand new dash speaker grill from Classic Industries®. This grill is manufactured in black ABS plastic which can be painted with a variety of OEM® paints. Original hardware must be reused.
 ME1451 1970-74 Barracuda, Cuda..... 79.99 ea
 ME1452 1970 Challenger..... 79.99 ea
 ME1451 1971-74 Challenger..... 79.99 ea

B DASH & CONSOLE COMPONENTS

In-Dash Audio

RediRad



RB336



RB332

Stock Replacement Speakers

These Retro style speakers are just what your looking for to finish your sound system. These speakers have a acoustically transparent cone to protect drivers and cone from the elements. They have a 3-way midrange tweeter to accurately reproduce midrange and high frequencies. The Dual Voice Coil speakers features a custom tuned, low profile basket, ultra thin Neodymium magnet structure allowing mounting options that no speaker can match. Choose from speaker sizes listed below. *Note: Grill covers not included.*

Single Voice Coil - Universal Application

RB335 35 watts max 3.5" round..... 57.99 pr

RB336 100 watts max 6.5" round..... 89.99 pr

Dual Voice Coil - 1968-72 Road Runner

RB332 1968-72 - 60 watts max 4" x 10"..... 75.99 ea

Dual Voice Coil - Universal Application

RB333 100 watt max 5" x 7"..... 65.99 ea

RB334 200 watt max 6" x 9"..... 79.99 ea

RediRad



Low Profile Replacement Speakers

These 4" x 6" oval speakers include grills, they are designed and sized to fit in an OEM or a custom location, due to their ultra thin mounting profile, you can mount it places other speakers cannot fit. Please note that you are purchasing TWO 4" x 6" Single Voice Coil speakers, which are full range speakers with a low profile cool flame style Mylar tweeter assembly, Single Voice Coil System, rigid poly cone, Santoprene surround, 1.65" thin mounting depth and custom tooled low carbon steel chrome basket.

Single Voice Coil - Universal Application

RB338 150 watts max 4" x 6"..... 79.99 pr



UNDERCOVER I Stealth Speaker

This speaker system is designed specifically for under seat or horizontal wall installations. The compact ABS housing contains one 5-1/2" woofer and Piezo tweeter in each enclosure and is only 2-7/8" high x 8" x 11". This system sounds very good and can handle up to 120 watts. For a great sound combine these with one of our DVC (dual voice coil) speakers in the dash and you'll have a great system without any vehicle modifications.

S5060 6 OHM..... 109.99 pr



UNDERCOVER II Upgrade Speakers

We have developed the UNDERCOVER II with an 8" woofer and 2 Piezo tweeters in each box. This system can be mounted in many of the same locations as the regular UNDERCOVER. With the 8" woofer in UNDERCOVER II you get a much fuller deeper sound. These are a great addition to our Concours series radios with their 200 watt capacity. Sold in pairs. Measure 11"W x 12.5"D x 3"H

Note: These speakers have a 4 ohm rating. Check for compatibility with your audio system.

S5064 129.99 pr



MB2099

1968-69 Road Runner Dual Speakers

Upgrade your original single dash speaker to a dual speaker system. This speaker set is available for 1968-69 Road Runner models and features two 4" speakers in your choice of 30-watt or 80-watt amperage.

MB2098 1968-69 30-watt..... 44.99 ea

MB2099 1968-69 Kenwood 80-watt..... 99.99 ea



1970-74 B & E-Body Dash Center Speaker

Replacement center dash speaker for 1971-74 B-Body and 1970-74 E-Body models. This dual voice coil speaker measures 4" x 10", handles up to 80 watts and will mount to the dash without modifications.

MD7123 1971-74 B-Body..... 54.99 ea

MD7123 1970-74 E-Body..... 54.99 ea



- Compact Footprint: 9" x 2.75" x 13.75"
- 100 Watt Max Power Output
- High/Low Level Inputs
- Adjustable Crossover Network (50-100Hz)
- 180° Phase Control
- 35-100 Hz Frequency Response Range

Powered 8" Subwoofer

Retrosound's new powered subwoofer is a great way to add some bass to your audio system. This low profile subwoofer features a die-cast aluminum enclosure for optimal heat dissipation and has a compact footprint for easy mounting under or behind seats. Measures 9" x 2.75" x 13.75".

RB450 8" subwoofer..... 199.99 ea



Portable MP3/Media Adapter

You now have the freedom to listen to your favorite music in your classic car with the RediRad adapter, the only portable music adapter specially designed for older vehicles. The music is seamlessly routed from any portable music player such as a cassette, CD or MP3 player, even satellite radio into your AM or AM/FM radio without any vehicle modifications. Designed for simple and out-of-sight installation, it uses a standard audio plug on a six foot cable to connect to your portable player. When music is detected at the audio plug, the RediRad automatically switches from the radio broadcast to your personal player. The radio will return to normal operation after switching off the personal player. A great way to preserve the original appearance and maximize your vehicle's collector value while still listening to your tunes in modern style!

14923 RediRad adapter..... 99.99 ea



Listen To Your Radio Without The Key

This allows you to continue listening to the radio for 15 minutes or until a door is opened without leaving the electric fan or other accessories running. And you're not limited to just the radio; this device could be wired to control all accessory power so you still have control of the power windows after the key is off.

RE12005 1960-68 radio off delay 64.99 ea



top

bottom

1968-74 Speaker Fader Bezel Nut Tool

These bezel nut tools are used for removing the speaker and fader control switch from the dash. Designed to interlock with the recessed dimples on the outside edge of the bezel nut to avoid any other contact that can cause damage. Made in the USA.

MF1743 1968-74 all 10.99 ea



1970-74 E-Body DeRooster/Speaker Housing

Replacement rear defroster/speaker housing for 1970-74 E-Body models. Manufactured from pot metal, this housing mounts under the rear package shelf and houses the rear blower motor and passenger side speaker.

ME8135 1970-74 E-Body..... 169.99 ea

Audio Components



Retro Style Color Bars

Reproduction aftermarket color bars made popular on cars from the 1950s through the 70s. There was no better feeling than cruising while the lights danced to the beat of the music. The color bar compliments your interior and gives it that back-in-the-day look. This cool accessory can be mounted anywhere and is run through your stereo to light up and move to the music. Available in a brilliant chrome finish or a black powder coat finish. Includes two different interchangeable lenses for two different lighting affects. Mounting hardware and instructions also included.

14611 black..... 219.99 ea
 14612 chrome..... 279.99 ea



Boman Style Radio Color Bar

This accessory radio color bar from "back in the day" can be installed in any year or model car or truck with a 12 volt power system. Popular in cars of the late 50s and early 60s, the bar lights up and is synchronized to the music playing through your speakers. Installs under the center dash, glove box or any location you choose.

Note: Mounting brackets not included.

C9077 12 volt..... 139.99 ea



MA1540



MA1541



MA1542

MA1542 - detail

Custom
 autosound

1967-76 Custom Autosound A-Body Kick Panel Speaker Systems

Want more sound without cutting or drilling on your classic A-Body? Now you can with Custom Autosound's new kick panel speaker assemblies! These new kick panels sound great, enhance interior appearance and affords a "no modification" fit. All models are black ABS plastic that can be left as is or painted to match your interior. They come fitted with CA's 4" x 6" 80 watt speakers or you can get the upgraded version that is fitted with Pioneer 4" x 6" 120 watt speakers.

MA1540 1967-76 w/o speakers 74.99 pr
 MA1541 1967-76 80 watt 119.99 pr
 MA1542 1967-76 120 watt 179.99 pr



MAR19101



MAR19102



ME176501



ME176502

1967-76 Kick Panel Speaker Systems

If years of faithful motoring have taken their toll on the interior of your A or E-Body Mopar, then these kick panels are for you. Manufactured from durable ABS plastic with factory style grain, these kick panels feature premium 4" Kenwood speakers to bring more sound into your Mopar while renewing the appearance of your interior. Have your own 4" speakers to use? No problem! Simply order the kick panels with speaker cutouts and install your preferred audio equipment. These panels are available in black only, but may be dyed to match any interior with OER Premium interior paint products. Update your stereo without hacking up your interior!

A-Body
 MAR19101 1967-76 with 4" speakers..... 179.99 pr
 MAR19102 1967-76 with speaker cutouts 99.99 pr
E-Body
 ME176501 1970-74 with 4" speakers..... 179.99 pr
 ME176502 1970-74 with speaker cutouts 109.99 pr

Antenna Components

New!



MB2022 Detail



Authentic Performance



MA1538



MB2022

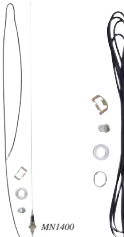

MN1400



MN1402

1962-74 Antenna Sets

Reproduction antenna sets for 1962-74 models. Replace your damaged or missing original with a quality telescoping antenna. Features correct chrome finish and includes the OE style mast, retainer, bezel, gasket, coax cable and chrome retainer nut. Antennas have telescoping mast, except where noted.

A-Body

MN1393	1962-65	149.99 set
MN1394	1966-67	except Barracuda	149.99 set
MA1439	1966-67	Barracuda	159.99 set
MN2110	1968-69	Charger	124.99 set
MA1538	1968-74	except Barracuda	119.99 set

B-Body

MN1396	1962-65	159.99 set
MN3062	1966-67	Charger	149.99 set
MB2022	1968-70	except Charger	199.99 set
MB2023	1968-70	Charger	99.99 set
MN1400	1971-74	Dodge, fixed mast	134.99 set
MN1401	1971-74	Plymouth fixed mast	134.99 set

Challenger

MN1402	1970	T/A, qtr. mounted	134.99 set
ME1335	1970-74	119.99 set

Barracuda

MN1402	1970	AAR, qtr. mounted	134.99 set
ME1334	1970-74	119.99 set

New!

RetroSound



MA4739



manual detail



power detail

MA4741

1962-76 Antennas

RetroSound replacement antennas are a great way to replace your rusty, non-working original. These antennas are made with brass and chrome plated for a long lasting, show-quality finish. Antennas include an OE-style chrome bezel, all metal mounting hardware, and a new antenna cable. Your choice of manual or power retractable antenna.

A-Body

Manual Antennas			
MA4741	1962-65	Dart	59.99 ea
MA4742	1968-70	Dart	59.99 ea
MA4742	1968-74	Valiant	59.99 ea
MA4742	1970-74	Duster	59.99 ea
MA4742	1971-72	Demon	59.99 ea
MA4742	1973-76	Dart Sport	59.99 ea
Power Antennas			
MA4739	1962-65	Dart	139.99 ea
MA4740	1968-70	Valiant	139.99 ea
MA4740	1968-74	Duster	139.99 ea
MA4740	1970-74	Demon	139.99 ea
MA4740	1971-72	Dart Sport	139.99 ea
MA4740	1973-76	Dart Sport	139.99 ea

B-Body

Manual Antennas			
MB2676	1968-70	Charger	59.99 ea
MB2676	1968-70	Road Runner	59.99 ea
MB2676	1968-70	Coronet	59.99 ea
MB2676	1968-70	GTX	59.99 ea
MB2676	1968-71	Belvedere	59.99 ea
Power Antennas			
MB2675	1968-70	Charger	139.99 ea
MB2675	1968-70	Road Runner	139.99 ea
MB2675	1968-70	Coronet	139.99 ea
MB2675	1968-70	GTX	139.99 ea
MB2675	1968-71	Belvedere	139.99 ea

E-Body

Manual Antennas			
ME1016	1971-74	Barracuda	59.99 ea
ME1017	1971-74	Challenger	59.99 ea
Power Antennas			
ME1014	1971-74	Barracuda	139.99 ea
ME1015	1970-74	Challenger	139.99 ea



Universal Power Antenna

Just think of how much easier it would be to put on or take off your car cover without the hassle of a fixed mast antenna. Automatically raises when radio is turned on and retracts when radio is turned off. Includes 5 different angled mounting bases to ensure a custom fit. Requires 11.5" mounting depth inside fender. AN74 universal power antenna..... 89.99 ea



The Smart Antenna

If you want great reception without a visible antenna, then The Smart Antenna is what you need! The antenna is totally self contained using printed circuit technology and miniaturized components, coupled with high-quality manufacturing methods. You don't need an external rod, no drilling to install, no removal prior to car wash, concealed mounting prevents theft and also includes a lifetime warranty! Antenna cable measures 9 feet long. SA20 fits all years. 21.99 ea

AUTHORIZED



2770138



MA1539



ME1536



MD2099

1967-74 Antenna Bezels

Replace your pitted or missing antenna bezel with these quality reproductions that fit a variety of 1967-74 models. Each bezel features correct triple chrome plating.

Note: *Except Barracuda models.*

Antenna Bezels

2770138	1967	A-Body	19.99 ea
MA1539	*1968-74	A-Body	14.99 ea
2889926	1968-69	Barracuda	14.99 ea
MB2028	1968-70	Charger	14.99 ea
MB2028	1968-70	B-Body exc. Charger	24.99 ea
ME1536	1970-74	Barracuda	9.99 ea
ME1537	1970-74	Challenger	14.99 ea
MD2099	1966-76	all	2.99 ea

Gasket

MB2025 1968-74 all..... 2.99 ea



MB2025



S21600

1965-89 Antenna Lock Nut Tools

1965-89 Antenna Nut Tool

Specialty tool required for proper installation and removal of the antenna nut.

MB2024	1965-67	B-Body	10.99 ea
MB2025	1968-74	A, B, E-Body	10.99 ea
MF1738	1967-78	2 sided, non-power	19.99 ea
MF1739	1972-89	power models	12.99 ea
MF1740	1965-68	8 notch nuts	10.99 ea

Antenna Wrench

Simple and compact, this tool fits most antenna bezel nuts for easy antenna removal. Compared to other tools, it is easier to carry and use and won't damage the nut. Rugged steel construction for years of use. S21600..... 21.99 ea

1968-74 Antenna Lock Nut



Replacement antenna lock nut for all 1968-74 models. This lock nut is required to secure your antenna. Designed for an authentic appearance and features triple chrome plating. MB2026 1968-74 all models..... 24.99 ea



Dash Components



AUTHENTIC
RESTORATION

1968-74 A-Body Emergency Brake Handle

Replacement emergency brake handle for 1968-74 A-Body models. Features correct black finish and white lettering. Includes new roll pin.
MA2060 1968-74 A-Body brake handle 27.99 ea



MA2195

AUTHENTIC
RESTORATION

1967-76 Hood Release Cables

Hood release cables for 1967-76 A-Body, 1971-74 B-Body and 1970-74 E-Body vehicles. Features correct "HOOD" lettering and includes the mounting bracket. Chrome release handles are included on 1967-76 A and 1971-74 B-Body models.

MA2195 1967-76 A-Body 84.99 ea
MB2286 1971-74 B-Body 84.99 ea
ME753 1970-74 E-Body 74.99 ea



MA1096



MB898



ME1495

Made in USA

1966-76 Under Dash Insulation

Eliminate noise and vibration coming from beneath your dash with new die-cut insulation. Manufactured to original specifications. Made in USA.

1967-76 A-Body
MA1096 1967-76 all models 17.99 ea
1966-70 B-Body
MB898 1966-70 all models 17.99 ea
1970-74 E-Body
ME1495 1970-74 all models 17.99 ea



MB325



MB2038

AUTHENTIC
RESTORATION

1968-74 B-Body Dash Vent Cable

Under dash vent cables with correct knobs for 1968-74 B-Body vehicles. Cables for 1968-70 models feature square knobs with white incised "VENT" markings and will fit vehicles with or without AC. 1971-74 models feature the round knurled knobs and only fit vehicles without AC.

With or Without AC
MB325 1968-70 LH, square knob 49.99 ea
MB326 1968-70 RH, square knob 49.99 ea
Without AC
MB2039 1971-74 LH, round knob 54.99 ea
MB2038 1971-74 RH, round knob 49.99 ea



ME1317



ME1319

AUTHENTIC
RESTORATION

1970-74 E-Body Dash Vent Cable

Under dash vent cable with correct knob for 1970-74 Barracuda and Challenger models without AC. These quality vent cables replace broken, rusted, or missing original cables. 1970 model features square knobs and white incised "VENT" markings while the 1971-74 models feature the round knurled knobs.

ME1317 1970 LH, square knob 54.99 ea
ME1318 1970 RH, square knob 54.99 ea
ME1319 1971-74 LH, round knob 54.99 ea
ME1320 1971-74 RH, round knob 54.99 ea



MB2018



MB2019



ME1332

AUTHENTIC
RESTORATION

1968-74 B & E-Body Heater/Defrost Cable

Heater control cable for various 1968-74 B-Body models and 1970-74 E-Body models without air conditioning.

B-Body
MB2018 1968-70 w/o AC 24.99 ea
MB2019 1971-74 w/o AC 44.99 ea
E-Body
ME1332 1970-74 w/o AC 34.99 ea



MB2020



ME1333

AUTHENTIC
RESTORATION

1968-74 B & E-Body Temp Control Cable

This cable runs from the temperature knob through the firewall and it attaches to the heater control valve. Available for various 1968-74 B-Body models and 1970-74 E-Body models without air conditioning.

B-Body
MB2020 1968-70 w/o AC 24.99 ea
MB2021 1971-74 w/o AC 39.99 ea
E-Body
ME1333 1970-74 w/o AC 39.99 ea



MD109



MD104

MD105

AUTHENTIC
RESTORATION

MD106

1962-76 A & B-Body Dash Vents & Hoses

Dash vents that install on top of the dash on each side of the speaker grill and direct airflow into the passenger compartment.

Dash Vent & Hose Set

Set includes 2 vents, 2 hoses and mounting nuts. Sets for 1968-70 B-Body vehicles with AC include all components in the non-AC set plus 2 spacers.

A-Body
MD107 1963-66 all 104.99 set
MD108 1967-76 w/o AC 109.99 set
MA136 1967-76 w/AC 114.99 set
B-Body
MD107 1962-65 all 104.99 set
MD109 1968-70 w/o AC 104.99 set
MD110 1968-70 w/AC 114.99 set

Dash Vents

These plastic vents mount on the dash and direct airflow into the passenger compartment. Applications are available for a variety of 1962-76 A and B-Body vehicles. Hardware included.

A-Body
MD104 1963-66 59.99 pr
MD105 1967-76 59.99 pr
B-Body
MD104 1962-65 59.99 pr
MD106 1968-70 59.99 pr

B DASH & CONSOLE COMPONENTS

Dash Components



MD114



1962-76 A & B-Body Dash Vent Hoses

These hoses attach to the dash vents located on top of the dash on each side of the speaker grill and direct airflow into the passenger compartment.

A-Body

MD112	1963-66	all	49.99	pr
MD113	1967-76	w/o AC	49.99	pr
MA137	1967-76	w/AC	59.99	pr

B-Body

MD112	1962-65	all	49.99	pr
MD114	1968-70	w/o AC	49.99	pr
MD115	1968-70	w/AC	49.99	pr



MB2016



1968-70 B-Body Side Vent Hose Sets

Replacement side vent hose sets for 1968-70 B-Body models. This set is for the front vents located on each side of the dash. Includes hoses, adapters and 18 screws. For models equipped with air conditioning. Some assembly required.

MB2015	1968-69	all models	54.99	set
MB2016	1970	early models	54.99	set
MB2017	1970	late models	54.99	set



MA668004

1967-69 Dart AC/Heater Control Bezels

These reproduction air conditioning dash bezels for 1967-69 Dart models are manufactured in injection molded plastic with the correct chrome, satin silver, and black details to provide a precise replacement. MA668003 1967-69 bezel w/o AC..... 164.99 ea
MA668004 1967-69 bezel w/AC..... 164.99 ea



ME1762

1970-74 E-Body Heater & AC Control Panel

Reproduction AC/heater control panel for 1970-74 E-Body models with the Rallye dash option. Manufactured in injection molded ABS plastic and features the correct fonts, grain, and chrome trim as original.

ME1450	heater control panel	121.99	ea
ME1762	AC/heater control panel	229.99	ea
ME1763	AC/heater switch bezel only	104.99	ea



1967-76 A-Body AC Control Panel Wafers

Reproduction AC control panel wafers for 1967-76 A-Body models. Manufactured in plastic as original for an authentic replacement.

MA890101	1967-76	5 piece set	12.99	set
----------	---------	-------------	-------	-----

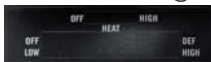

MB280954

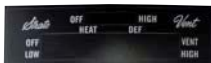

MB280956



MB280957



MB280955

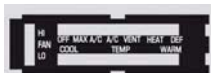

MB280958



MB280961



MB280962

Heater/AC Control And Dash Decals

Finish restoring your B-Body dash with these premium quality dash bezel legend and heater/AC control decals. All fonts and colors are correct and will give your standard or Rallye dash a factory new look again.

Note: Heater/AC control decals fit both standard and Rallye dashes.

Heater/AC Controls

Without AC				
MB280954	1971-72	w/o Strato vent	11.99	ea
MB280956	1971-72	w/Strato vent	11.99	ea
MB280957	1973-74		11.99	ea
With AC				
MB280955	1971-72	w/AC	11.99	ea
MB280958	1973-74	w/AC w/vent	11.99	ea

Dash Bezel Legends

MB280961	1971-72	Rallye dash	8.99	set
MB280962	1973-74	Rallye dash	8.99	set



MA890102



AC Control Panel Light Reflector Shrouds

Reproduction AC control panel light reflector shrouds for 1967-76 A & B-Body models. Manufactured in cardboard as original for an authentic replacement.

A-Body

MA890102	1967-76	5.99	set
----------	---------	------	-----

B-Body

MB880104	1968-70	5.99	set
----------	---------	------	-----



1968-70 B-Body Heater Control Bezel

Reproduction of the original heater control bezel for 1968-70 B-Body models. This piece mounts under the dash and features the correct chrome finish. Fits 1968-70 Belvedere, Charger, Coronet, GTX, Satellite and Road Runner.

MB1238	1968-70	99.99	ea
--------	---------	-------	----



MB880106



MB880105

1968-70 Heater/AC Control Button Labels

Restore your B-Body heater and AC control panel slider buttons without breaking the bank! These labels restore the appearance of your control panel sliders exactly. MB880106 1968-70 w/o AC..... 12.99 set
MB880105 1969-70 w/AC..... 12.99 set

More AC & Heater Parts

Refer to AC, Heater & Cooling System section (Section J) to see the full selection of AC & Heater Products.



- Heater Box
- Vent Tubes
- Compressor
- AC Filters
- And Much More!



Please Refer to Section J

Dash Switch Components



1968-70 B-Body Dash Knob Sets

Replace damaged or missing dash knobs with these quality replacement dash knobs. Feature correct contours and chrome finish. Available for all 1968-1970 B-Body models.

MB1232	1968-69	Charger	131.99 set
MB1233	1968-69	all except Charger	131.99 set
MB1234	1970	all exc Super Bird	109.99 set
MB1235	1970	Super Bird	109.99 set

AUTHENTIC RESTORATION

OEER AUTHORIZED

AUTHENTIC RESTORATION

OEER AUTHORIZED

AUTHENTIC RESTORATION



1963-64 A-Body Headlamp Switch

Headlamp switch assembly for 1963-64 A-Body models. This assembly includes the electrical switch, bezel and knob with a chrome finish and correct circling pattern. The headlamp switch knob and retaining nut are available separately.

1964 Headlamp Switch Assembly	
MA2068	1963-64 headlamp switch assembly
MA1530	1963-64 knob w/shaft
MA1140	1963-64 knob w/o shaft
1887984	1963-64 switch retaining nut

AUTHENTIC RESTORATION

AUTHENTIC RESTORATION

OEER AUTHORIZED

AUTHENTIC RESTORATION



1968 B-Body Rallye Dash Medallions

Replacement style medallions for 1968 B-Body models equipped with a Rallye dash. This commonly missing medallion installs at the top center of the dash between the speedometer and the tachometer.

MB1236	1968	R/T medallion	74.99 ea
MB1237	1968	Fratzog medallion	74.99 ea
MB1864	1968	Rallye dash medallion	74.99 ea

AUTHENTIC RESTORATION

OEER AUTHORIZED

AUTHENTIC RESTORATION

OEER AUTHORIZED

AUTHENTIC RESTORATION



1962-74 Mopar Headlamp Switch

Reproduction headlamp switch for various 1962-74 Mopar A and B-Body models. This 7-terminal switch features either a 1-1/4" or a 1-5/8" ceramic insulated rheostat.

Mopar A-Body (exc. 67-69 Barracuda)	
MD9341	1962-76 1-5/8" rheostat
Barracuda	
MD9337	1967-69 1-1/4" rheostat
Mopar B-Body	
MD9337	1962-67 1-1/4" rheostat
MD9341	1971-74 1-5/8" rheostat

AUTHENTIC RESTORATION

AUTHENTIC RESTORATION

OEER AUTHORIZED

AUTHENTIC RESTORATION

OEER AUTHORIZED



1960-76 Headlamp Dimmer Switch

Flickering or non-operational headlights could be the result of a burned out dimmer switch. Dimmer switches allow the driver to select and alternate between high and low beams. After years of continuous service, it is not uncommon for a dimmer switch to fail. Available for most 1960-76 A-body, B-body and E-body vehicles. 1881938 1960-76 floor mounted 9.99 ea

New!



Lamp Flasher

The 12 volt, 20 amp, 2 prong service replacement flasher was used on various models. Replace your non working flasher with this unit. G1391 20 amp 2 prong 13.99 ea



1966-67 Dodge B-Body Headlamp Switch Assembly and Parts

Replacement headlamp switch assembly for 1966-67 Charger and Coronet models. This assembly includes the electrical switch, bezel and knob with correct lettering. Individual components are also available separately.

Headlight Switch Assembly	
MB2033	1966-67 complete
Individual Components	
MB1240	1966-67 knob
MB1243	1966-67 bezel

OEER AUTHORIZED

AUTHENTIC RESTORATION



1968-69 Dodge Charger Headlamp Switch

Reproduction headlamp switch for 1968-69 Dodge Charger models. Manufactured to original specifications. 2864134 1968-69 24.99 ea

Made in USA



1962-74 Headlamp Switch Bezel Nut Tool

This tool fits 3/4" headlamp switch bezel nuts on 1962-74 Mopar models. Designed to interlock with the recessed dimples on the outside of your bezel nut to avoid causing damage. Made in the USA. MF1742 1962-74 10.99 ea

Dash Switch Components



1968-70 B-Body Dash Dimmer Switch

Reproduction dash dimmer switch for 1968-70 Dodge and Plymouth B-Body models. This dimmer assembly features a chrome plated thumb-wheel, a die cast body, and a ceramic plated switch as original. Installs in the gauge panel and controls the brightness of the dash lighting. Replaces OEM numbers 2932873, 2809047, 3420925, and 3514417.

MB16951 1968-70 B-Body..... 174.99 ea

NEW AUTHORIZED



MB1241



MB1242

1966-67 Dodge B-Body Wiper Switch Components

Wiper switch knob and bezel for 1966-67 Charger and Coronet models. This knob features correct lettering and chrome finish.

MB1241 1966-67 knob..... 15.99 ea
MB1242 1966-67 bezel..... 15.99 ea



Made in USA



1962-74 Wiper Switch Bezel Nut Tool

This tool fits 3/4" washer and wiper switch bezel nuts on 1962-74 Mopar models. Designed to interlock with the recessed dimples on the outside of your bezel nut to avoid causing damage. Made in USA.

MF1742 1962-74 all..... 10.99 ea



MD2140



MD1638

1960-76 A & B-Body Ignition Switches

Replace the non-operational ignition switch in your 1960-76 A or B-Body model with a quality ignition switch. Available for models without tilt column only. MD2140 1960-68 all..... 14.99 ea
MD2140 1971-76 Duster, Scamp..... 14.99 ea
MD1638 1969 all models..... 49.99 ea
MD2185 1970-76 all, w/o tilt..... 40.99 ea



1969 Ignition Switch Conversion

This kit allows you to convert your 1969 ignition switch to the less expensive 1960-68 ignition lock and ignition switch. Switch comes complete with Ignition Lock, Ignition Switch, Ignition Switch Nut, Installation Tool and Conversion Sleeve.

MN1772 1969 all..... 109.99 set

NEW AUTHORIZED



1966 Dodge B-Body Ignition Switch Bezel

Ignition switch bezel for 1966 Coronet and Charger models.

MB2193 1966 Coronet and Charger..... 12.99 ea

NEW AUTHORIZED



1969 A & B-Body Ignition Switch Bezel

Reproduction of the ignition switch bezel for 1969 Dodge and Plymouth A and B-body models. Manufactured with a chrome finish as original.

MB1471 1969..... 16.99 ea



Made in USA



MF1731



MF1732

1963-69 Ignition Switch Bezel Nut Tools

These ignition switch bezel nut tools are designed to interlock with the recessed dimples on the outside of your bezel nut to avoid scratching. Preserve your original bezel nut or install a new nut with this special tool. Made in USA.

MF1731 1962-64 Savoy, Fury..... 10.99 ea
MF1732 1963-64 Valiant..... 15.99 ea
MF1733 1963-68 A-Body..... 16.99 ea
MF1734 1962-65 B-Body..... 13.99 ea
MF1733 1966-68 B-Body..... 16.99 ea
MF1735 1969 A, B-Body..... 18.99 ea



The "Hot-Dot" All-In-One Ignition Switch

Convert your separate ignition switch and start button into one convenient unit with the "Hot-Dot" all-in-one ignition starter switch. Chrome recessed switch is 3/4" diameter with a colored LED ring to indicate when the ignition is "On". Push and hold the button while the starter turns over and release when the engine starts. The ignition stays "On". Push again to stop the engine. Includes installation instructions and is available with your choice of blue, green or red LED ring. Switches available separately. Can be used for positive or ground switching, rated 1 amp maximum load.

Hot-Dot Ignition Switch System

T70783 blue..... 179.99 ea
T70784 green..... 179.99 ea
T70785 red..... 179.99 ea

Hot-Dot Switches Only

Momentary

T70786 blue..... 51.99 ea
T70787 green..... 51.99 ea
T70788 red..... 51.99 ea

On/Off

T70789 blue..... 22.99 ea
T70790 green..... 49.99 ea
T70791 red..... 49.99 ea



FR6001

Touch Start Keyless Ignition System

The Igniter is carried by the driver which enables the ignition to start with just the push of a button. The system consists of a transponder, illuminated start/stop button, an internal antenna and 2 ignitors. You can put the button anywhere you want... the dash, console or hidden out of sight.

Important: The column mount button system will not actuate the steering column/ignition switch interlock on factory columns. The steering column lock will not remain functional.

Note: No further discounts apply.

FR60001 dash mount button system..... 799.99 ea
FR60002 column mount button system 1149.99 ea

Lock Components



1960-76 Ignition Locks

Replace your worn ignition lock assembly with a coded ignition lock complete with 2 keys.

<i>Without Tilt and Telescopic Wheel</i>			
MD2121	1960-68	all	24.99 ea
MD1631	1969	all	44.99 ea
MD2122	1970-71	all	24.99 ea
MD2123	1972-76	all	24.99 ea
<i>With Tilt and Telescopic Wheel</i>			
MD2124	1972-76	all	24.99 ea



1966-76 Ignition & Door Lock Sets

These lock sets are designed to replace your ignition and door lock assemblies. Each set comes complete with coded ignition and door locks with keys, pawls, clips and gaskets.

Note: Not for fiber optic applications.

Sets With Pentastar Logo Keys

<i>A-Body</i>			
MD3132	1966-68		54.99 set
MD3133	1970-71		54.99 set
MD3134	1972-76	w/o tilt & telescopic	54.99 set
MD3135	1972-76	w/tilt & telescopic	54.99 set
<i>B-Body</i>			
MD3132	1966-68		54.99 set
MD3133	1970-71		54.99 set
MD3134	1972-76	w/o tilt & telescopic	54.99 set
MD3135	1972-76	w/tilt & telescopic	54.99 set

Sets With Replacement-Style Keys

<i>A-Body</i>			
MD2132	1966-68		44.99 set
MD1634	1969		44.99 set
MD2133	1970-71		44.99 set
MD2134	1972-76	w/o tilt & telescopic	44.99 set
MD2135	1972-76	w/tilt & telescopic	44.99 set
<i>B-Body</i>			
MD2132	1966-68		44.99 set
MD1634	1969		59.99 set
MD2133	1970-71		44.99 set
MD2134	1972-76	w/o tilt & telescopic	44.99 set
MD2135	1972-76	w/tilt & telescopic	44.99 set
<i>E-Body</i>			
MD1640	1970-71		49.99 set
MD1635	1972-74		49.99 set



1966-76 Door Locks

Replace your worn door locks with a coded door lock set complete with 2 coded lock cylinders, 2 keys, lock pawls and retaining brackets. Available in illuminated style with 3" fiber optic cables. In some cases you will have to reuse your original optic cables.

<i>A & B-Body</i>			
MD2130	1966-76	non-illuminated	24.99 set
<i>E-Body</i>			
MD1632	1970-74	E-Body	24.99 set



1970-74 Glove & Trunk Lock Sets

Replacement glove & trunk lock set for various 1970-74 models. Each set includes coded lock, keys, and shafts where required on specific applications.

<i>A-Body</i>			
MD1639	1970-72	all	64.99 set
MD1641	1973-74	all	59.99 set
<i>B-Body</i>			
MD1639	1970	all	64.99 set
MD1642	1971-72	all	64.99 set
MD1643	1973-74	all	64.99 set
<i>E-Body</i>			
MD1639	1970-71	Challenger	64.99 set
MD1644	1971-72	Barracuda, 'Cuda	89.99 set
MD1641	1973-74	Challenger	59.99 set
MD1645	1973-74	Barracuda, 'Cuda	79.99 set



1966-76 Trunk Lock Sets

Complete trunk lock set for 1966-76 models includes coded lock, an assortment of lock shafts for different models and styles, lock bracket and mounting gasket.

<i>A & B-Body</i>			
MB192020	1966-67	black, w/key	49.99 pr
MD2136	1966-72	w/replacement keys	16.99 set
MD2146	1966-72	w/original keys	34.99 set
MD2137	1973-76	w/original keys	19.99 set
<i>E-Body</i>			
MD2136	1970-71	w/replacement keys - Challenger	16.99 set
MD2146	1970-71	w/original keys - Challenger	34.99 set
MD2137	1973-74	w/original keys - Challenger	19.99 set
MD1636	1970-71	w/original keys - Barracuda, 'Cuda	49.99 set
MD1637	1973-74	w/original keys - Barracuda, 'Cuda	49.99 set

E DASH & CONSOLE COMPONENTS

Dash Components



ME1494

1960-74 Replacement Glove Box Liners

Manufactured to match the originals in every detail, these glove box liners are designed for a variety of A-Body, B-Body and E-Body vehicles. Made in USA.

1960-69 A-Body

<i>Lancer, Valiant</i>	
MA583 1960-62	22.99 ea
<i>Barracuda, Dart, Valiant</i>	
MA584 1963-66	19.99 ea
MA585 1967	14.99 ea
MA586 1968-69	15.99 ea

1970-74 A-Body

Fits 1970-74 A-Body vehicles such as Dart, Dart Sport, Demon, Duster, Scamp and Valiant.

MA586 1970-74	15.99 ea
---------------	----------

1962-64 B-Body

Designed for B-Body vehicles such as 1962 Belvedere, Dart, Fury, Polara 500, Savoy, Sport Fury as well as 1963-64 models including 330, 440, Belvedere, Fury, Polara, Polara 500, Savoy and Sport Fury.

MB887 1962 w/o AC	19.99 ea
MB888 1963 w/o AC	29.99 ea
MB889 1964 with AC	19.99 ea
MB890 1964 w/o AC	19.99 ea

1965 B-Body

MB889 1965 with AC	19.99 ea
MB890 1965 w/o AC	19.99 ea

1966-67 B-Body

MB891 1966-67 all models	12.99 pr
--------------------------	----------

1968-70 B-Body

MB892 1968	12.99 ea
MB893 1969	12.99 ea
MB894 1970	12.99 ea

1970-74 E-Body

ME1494 1970-74 all models	12.99 ea
---------------------------	----------

RON FRANCIS WIRING



1962-79 Under Dash Courtesy Lamp

Set positions two lamps under corners of the dashboard. Controlled by turning the headlight switch knob and/or door jamb switches. Special sockets/brackets and bulbs included.

TF900631 1962-79	46.99 set
------------------	-----------



Courtesy Lamp Set

This set includes switches, wires, and light sockets to install courtesy lights in your vehicle.

Note: No further discounts apply.	
30704 universal set	42.99 set

New!



OER

Glove Box Clip

These OER reproduction stamped metal clips attach to the glove box liner in various Dodge and Plymouth models. These clips allow the liner to be attached in place in the dash.

K1101 each	99 ea
R5432 set of 10	8.99 set

New!



1968-69 B-Body Glove Box Catch

Reproduction glove box catch bar for 1968-69 B-Body models. This spring loaded catch bar assembly attaches to the dash and engages with the glove box lock when the glove box door closes.

MP14051 1968-69	23.99 ea
-----------------	----------



MD47302

1968-76 Dash Mounted Indicator Light

Reproduction indicator light for 1968-76 Mopar A/B/E-Body models. Manufactured in die cast zinc, this all new light features a bright chrome finish and correct lens. Includes mounting nut and wire.

MD47301 1968-76 reverse indicator	104.99 ea
MD47302 1968-76 seat belt warning	104.99 ea



1891

1893

1964-74 Glove Box Lamps

Correct replacement bulb for various A, B and E-Body vehicles. See bulb chart in information section for specific applications.

1891 1964-74 glove box bulb	1.99 ea
1893 1964-74 glove box bulb	1.99 ea

New!



1968-76 Glove Box Lamp Lens

Reproduction glove box lamp lens for 1968-76 Mopar models. Manufactured to factory standards to replace that original cracked or missing lens with a brand new lens.

MN3255 1968-76	14.99 ea
----------------	----------



1967-70 B-Body Map Light Lens

Map light lens set for 1967-70 B-Body models. Includes mounting hardware. Fits 1967-70 Belvedere, Charger, Coronet, GTX Satellite and 1968-70 Road Runner.

MB1500 1967-70 map light lens	14.99 set
-------------------------------	-----------



MB184501



MB184502

1971-72 B-Body Map Lights

Reproduction map light assemblies and map light blanks for 1971-72 Dodge and Plymouth B-Body models. These reproductions are designed to look and install just like the original, but are designed to be more durable and to accept both incandescent and LED bulbs. Fits all 1971-74 B-Body models, but is cosmetically correct for 1971-72 only.

MB184501 1971-72 assembly	99.99 ea
MB184502 1971-72 blank	26.99 ea



905003



pink purple titanium black

Spotlight Rechargeable LED Light

Ever needed a light but your batteries were dead? These 12V LED rechargeable lights charge in your cigarette lighter outlet, provide about 2 hours of light per charge, and hold a charge for over 18 months. Each is water resistant, and features red glow charge indicator. Shines 100 feet.

905003 red	19.99 ea
905103 orange	19.99 ea
905203 yellow	19.99 ea
905303 green	19.99 ea
905403 blue	19.99 ea
905503 pink	19.99 ea
905603 purple	19.99 ea
905803 titanium	19.99 ea
905903 black	19.99 ea

Steering Column



1970-74 E-Body Tilt Steering Columns

These brand-new, premium tilt steering columns are designed as a direct bolt in and connects directly to a manual, power or even rack & pinion steering application with a single U-Joint change. These Made To Fit columns are 100% American made and features 8-position tilt, GM style ignition switch with 2 GM style coded keys, includes the floor mount and wiring harness adaptor. Also includes all levers and knobs and are completely wired for self canceling turn signals, 4-way flashers and horn. Offered in paintable-steel, chrome and black powder coated. Made in the USA.

Note: No further discounts apply.

Tilt Column For OE Steering Wheel	MSRP
MW800 paintable steel.....	834.99 ea
MW727 chrome.....	979.99 ea
MW728 black powder coat.....	979.99 ea
Tilt Column For Aftermarket Steering Wheel	
MW729 paintable steel.....	779.99 ea
MW730 chrome.....	884.99 ea
MW731 black powder coat.....	889.99 ea



Ididit Steering Wheel Adaptor

When installing your aftermarket steering wheel you will need the correct adaptor for the installation. Classic Industries® offers a 3-bolt steering wheel adaptor for your 1970-74 Cuda or Challenger for an easy installation of your aftermarket wheel to an Ididit column. Made in the USA.

Note: No further discounts apply.

3-Bolt Adaptor	MSRP
MW732 chrome.....	109.99 ea
MW733 brushed.....	74.99 ea
MW734 polished.....	74.99 ea
MW735 black powder coated.....	109.99 ea
Horn Kit	
MW797 for Grant Tuff steering wheels	9.99 kit



U-Joints for Installation

To complete installing your ididit column to your steering gear box; you will need the proper u-joint for easy installation. Made in USA.

SC1017 manual 3/4" DD x 36.....	74.99 ea
MW736 power 3/4" DD x 36C.....	74.99 ea

1967-81 Tilt Steering Column Bracket

This unique steering column clamp bracket is needed to mount Flaming River steering columns. This polished billet aluminum clamp will attach the steering column to the factory dash on 1960-76 Mopar models.

Note: No further discounts apply.

FR20114K 1967-81.....	89.99 ea
-----------------------	----------



1962-74 Flaming River Tilt Columns

Get an all-new USA-made Flaming River Tilt Steering Column for your Mopar and stop the search for a used or rebuilt original. Flaming River offers keyed and non-keyed slip adjustable tilt columns that can be used for a variety of Mopar applications from 1962-74. The column is an overall length of 45 inches including an additional slip shaft extension. This allows for 1-1/2" of slip movement and includes a universal joint for direct connection to the steering box. Each column includes new turn signal/hazard switch and female adaptor plug kit for connecting to original wiring harness. All Flaming River® columns are made from 304 grade stainless steel.

Note: May need to reuse mounting parts from old column or use a column drop for mounting column to dash. Horn relay, hazard kit and steering wheel adaptor may be required (sold separately). No further discounts apply.

Floor Shift-Without Key Switch

Manual Box	
MW700 paintable mill finish.....	521.99 ea
MW701 polished stainless steel.....	669.99 ea

Power Box

MW702 paintable mill finish.....	526.99 ea
----------------------------------	-----------

Floor Shift-With Key Switch

Manual Box	
MW704 paintable mill finish.....	709.99 ea
MW705 black powder coat.....	804.99 ea
MW706 polished stainless steel.....	879.99 ea

Power Box

MW707 paintable mill finish.....	709.99 ea
MW708 black powder coat.....	804.99 ea
MW709 polished stainless steel.....	879.99 ea



Flaming River Steering Wheel Adaptors

Adaptors for Flaming River® steering wheels to be installed on Mopar steering columns or for the Tuff Wheel to be installed on the Flaming River® tilt column. Tuff wheel adaptor includes horn button. Made in the USA.

Note: No further discounts apply.

Adaptor for Original Steering Columns

Up to 1969	
MW716 5/6" bolt.....	119.99 ea
MW717 waterfall.....	129.99 ea
From 1970 (Except E-Body)	
MW718 5/6" bolt.....	119.99 ea
MW720 waterfall.....	129.99 ea
1970-74 E-Body	
MW719 1970-74 5/6" bolt E-Body.....	104.99 ea
MW721 1970-74 waterfall E-Body.....	104.99 ea

Adaptor for Flaming River® Tilt Column

1960-74	
MW722 for Tuff Wheel, w/horn button	104.99 ea



Power to Manual Steering Coupler

Simplifies installation and eliminates factory coupler when converting from power to manual steering. Includes a coupler to fit the manual steering box, a connecting shaft and a column universal joint. It is a must when converting from power to manual. Made in the USA.

Note: No further discounts apply.

MW724 1960-74.....	174.99 ea
--------------------	-----------



Flaming River Coupler Set

These coupler sets are designed to give you more head clearance by eliminating the old rag joint with your power steering gear box. Couplers are "Electroless" nickel plated for corrosion resistance. The length is 4-1/2 inches so it cannot be used for power to manual conversion; but it is the easiest installation for your existing set up. Made in the USA.

Note: No further discounts apply.

MW725 manual.....	204.99 ea
MW726 power.....	206.99 ea



Column Drops

Flaming River's column drops are machined from billet aluminum with a smooth radius edge. This sleek design is available in satin or mirror finish. Available in 2 inch diameter to fit both keyless and keyed column styles. Made in USA.

Note: No further discounts apply.

Without Key Switch	MSRP
MW710 satin finish.....	89.99 ea
MW711 polished finish.....	89.99 ea
With Key Switch	
MW712 satin finish.....	94.99 ea
MW713 polished finish.....	114.99 ea



1967-74 Steering Column Seals

Replacement steering column seals for 1967-74 A-Body, 1964-70 B-Body and 1970-74 E-Body models. Made in USA.

1967-74 A-Body	
MA9890 1967-74.....	5.99 ea
1964-70 B-Body	
MB2188 1964-65.....	5.99 ea
MB2189 1968-70.....	5.99 ea
1970-74 E-Body	
ME540 1970-74.....	4.99 ea

Steering Column

New!



2822789

2984581

OEI

1962-76 Lower Column Covers

Replacement lower steering column covers for 1967-76 A-Body and 1962-70 B-Body models. Includes mounting hardware unless noted otherwise.

Note: Hardware not included.

A-Body

2822789	1967-69	59.99	ea
2984581	1970-76	59.99	ea

B-Body

MN3252	1962-63	39.99	ea
MN3253	1964-65	39.99	ea
MW770	1968-69	49.99	ea
MW771	1970	w/Rallye dash	49.99
MW772	1970	w/o Rallye	39.99



1970-74 Steering Column Bracket

Reproduction of the bracket used to secure the steering column to the dash on 1970-74 Dodge Challenger models. Manufactured from steel and EDP coated for rust prevention.

ME8151	1970-74 Challenger	39.99	pr
--------	--------------------	-------	----

1971-74 Lower Column Seal Retainers

Replacement seal retainers for 1971-73 B-Body and E-Body and 1974 Challenger.

These retainers may have a split with a spring for installing the retainer without removing the steering column, others will be one piece. Seal retainers are available in white for the new look, or yellow for an aged look.



MW759

Non-Split Retainers			
MW757	white retainer only	29.99	ea
MW758	aged retainer only	34.99	ea
MW759	white retainer and seal only	39.99	ea
MW760	aged retainer and seal only	44.99	ea
Split Retainers			
MW761	white with spring	39.99	ea
MW762	aged with spring	44.99	ea
MW763	white with spring and seal	49.99	ea
MW764	aged with spring and seal	54.99	ea

1968-73 Lower Steering Column Bearing

Replacement lower steering column bearing for various 1968-73 models. If this bearing has not been changed; it is now about 30 to 40 years old. Replacing it will help to eliminate unnecessary play in your steering column.

Floor Shift - Manual & Auto

MW755	1968-73	all w/2 bolt mount	89.99	ea
-------	---------	--------------------	-------	----



MW768

1970-71 Lower Shift Tube Bushings

Replacement lower shift tube bushings for 1970 A, B and E-Body and 1971 A and B-Body models. These bushings need to be replaced to reduce movement and to improve the turning of the steering shaft. Very important when considering refurbishing a steering column. Available in white or aged (yellow) and either one-piece or split. Retainer clip is sold separately.

Non-Split Bearing

MW765	white bearing only	29.99	ea
MW766	aged bearing only	31.99	ea

Split Bearing

MW767	white and split with spring	39.99	ea
MW768	aged and split with spring	41.99	ea

Retainer Clip for Lower Shift Tube Bearing

MW769	fits non-split and split bearings	6.99	ea
-------	-----------------------------------	------	----



MW789

Steering Coupler Seal and Retainer

Lower steering column "swivel joint" seal and retainer for Mopar steering couplers. Available as a set with retainer in steel or stainless. Seal and retainers also available separately.

Seal with Retainer

MW789	steel retainer	21.99	set
MW790	stainless steel retainer	29.99	set

Seal

MD2595		14.99	ea
--------	--	-------	----

Retainer

MW791	steel	17.99	set
MW792	stainless steel	19.99	set



Made in USA

1962-76 Steering Column Spring Pin Tool

Remove the roll pin from rear wheel drive Mopar models equipped with a steering coupler. This tool features a knurled aluminum handle and hardened steel drive pin. Made in the USA.

Note: Not needed for models with rag joints.

MF1475	1962-76	all	16.99	ea
--------	---------	-----	-------	----

New!



1968-69 Column Shifter Eliminators

These steering column collars allow you to eliminate your stock column-shifter assembly in 1968-69 A and B-Body models. These collars will allow you to convert from a column shifter to a floor shifter.

MP14050	1968-69	shifter eliminators	144.99	pr
---------	---------	---------------------	--------	----



MD2138

1963-76 Turn Signal Switches

Replacement turn signal switch for a variety of 1963-76 models.

Note: Switch includes connector not shown.

MD2138	1963-66	all	144.99	ea
MD2139	1967-69	all	114.99	ea
MD2094	1970-76	A-Body	49.99	ea
MD2094	1970-74	B-Body	49.99	ea
MD2094	1971-74	E-Body	49.99	ea



MD2095

1963-74 Turn Signal Cancelling Cam

Turn signal cancelling cam for various 1963-74 models. Replace that worn and loose cancel cam with a new quality replacement cancel cam. No more sloppy turn signal arm or turn signal that won't cancel.

Without Tire Wheel

MD2095	1963-66	all	10.99	ea
MD2142	1970-74	all	10.99	ea

New!



SC1060



SC1061



DD100101

SC1062

Universal Cruise Control Units

Classic Industries offers cruise control units to upgrade your driving experience and are available for both computerized and non-computerized engines.

For computerized engines, this Rostra unit gathers information from your car's computer, so no external sensors are required. Adjustable for 2000, 4000 or 8000 pulses per mile. For non-computer engines, this Rostra electric servo unit uses solid state electronics for accuracy and reliability. Servo and control units are small enough to fit under any dash. Units include pulse generator and either a black column-mounted handle or black dash-mounted control.

Note: Discount exempt.

Cruise Control Units with Column Mounted Control

SC1059	w/electronic speed	259.99	set
SC1060	w/cable-driven speed	299.99	set

Cruise Control Units with Dash Mounted Control

CRS20002	w/cable-driven speed	299.99	set
CRS30002	w/electronic speed	259.99	set

Optional Accessories

SC1061	polished handle cover	34.99	ea
SC1062	brushed handle cover	34.99	ea
DD100101	dash mount c switch	54.99	ea

Steering Wheels



AMERICAN AUTHENTIC RESTORATION



1964-66 Steering Wheels

Reproduction steering wheels for 1964 A-Body and 1964-66 B-Body models. These steering wheels feature an authentic looking smooth finish and require the re-use of the original hardware for installation.

1964 A-Body and B-Body

MW6501 1964 black	259.99 ea
MW6502 1964 blue	269.99 ea
MW6503 1964 red	269.99 ea
MW6504 1964 tan	269.99 ea

1965-66 B-Body

MW737 1965-66 black	259.99 ea
MW738 1965-66 red	269.99 ea
MW739 1965-66 fawn gold	269.99 ea



AMERICAN AUTHENTIC RESTORATION



Smooth Finish



Pebble Finish

1967-70 Steering Wheels

Reproduction steering wheels for 1967-70 A-Body and B-Body models. These steering wheels feature an authentic looking smooth or pebble grain finish and require the re-use of the original hardware for installation.

Smooth Finish

MW740 1967-70 black	209.99 ea
MW741 1967-70 red	259.99 ea
MW742 1967-70 blue	259.99 ea
MW910 1967-70 green	259.99 ea
MW911 1967-70 tan	244.99 ea

Pebble Finish

MW743 1970 black	209.99 ea
MW744 1970 red	259.99 ea
MW745 1970 blue	259.99 ea
MW746 1970 green	259.99 ea
MW747 1970 tan	259.99 ea

New!



AMERICAN AUTHENTIC RESTORATION

4 Styles to Choose From



1968-70 A, B-Body Horn Pad Components

Reproduction of the woodgrain steering wheel horn cap pad and emblems for 1968-70 Mopar A and B-Body models. This horn cap pad utilizes the original hardware for installation. Officially licensed Morp Authentic Restoration Product.

Horn Pad

MW751 1968-70	114.99 ea
---------------	-----------

Horn Cap Adaptor

MW749 1968-69	horn button adaptor	104.99 ea
MW750 1970	horn button adaptor	184.99 ea

Horn Cap Emblems

2925137 1968-69	Dodge	56.99 ea
2880970 1968-69	Plymouth	70.99 ea
2950846 1969	Barracuda	44.99 ea
MW793 1969-70	Road Runner	14.99 ea

New!



AMERICAN AUTHENTIC RESTORATION

4 Styles to Choose From



1968-70 Wood Grain Steering Wheels

Reproduction deluxe or sport wood grain three-spoke steering wheel for 1968-70 A-Body and B-Body models. These steering wheels require the re-use of the original hardware for installation. Horn cap pad and emblems sold separately.

Individual Components

MW748 1968-69	steering wheel	424.99 ea
MW798 1970	steering wheel	424.99 ea
MW751 1968-70	horn cap pad	114.99 ea
MW749 1968-69	horn button adaptor	104.99 ea
MW750 1970	horn button adaptor	184.99 ea
MW931 1968-76	horn contact	34.99 ea

Buy the Kit and Save!

Steering wheel kits include the wood grain steering wheel, horn contact, horn cap pad, horn cap adaptor and the horn cap pad emblem.

With Wheel, Cap, Adaptor & Emblem

MW927 1968-69	Dodge	589.99 kit
MW926 1968-69	Plymouth	589.99 kit
MW928 1969	Barracuda	589.99 kit
MW914 1969	Road Runner	589.99 kit
MW915 1970	Road Runner	699.99 kit



1969-72 Road Runner Horn Pad Emblem

Reproduction steering wheel horn pad emblem or decal for 1969-72 Road Runner models. Freshen-up your standard steering wheel horn button with your choice of a quality injection molded plastic horn button emblem or an easy-to-apply Road Runner decal. The emblem is a correct injection molded part with proper silver border and premium Road Runner decal installed. Either option provides a finishing touch to your interior for added points at the next car show.

Injection Molded Emblem with Decal

MW793 1969-70	14.99 ea
MW795 1969-70	9.99 ea
MD4176 1972	6.99 ea

AMERICAN AUTHENTIC RESTORATION



1970 Barracuda Horn Cap Emblem

Reproduction Barracuda center cap emblem for 1970 Barracuda and 'Cuda models. This quality die-cast emblem will all the finishing touch to your Barracuda or 'Cuda Rim Blow or Tuft Wheel horn cap. MW794 1970 horn cap emblem..... 28.99 ea

New!

AMERICAN AUTHENTIC RESTORATION



MW799

MW930



MW931

6029392

1970-76 Tuff Wheel Mounting Components

Reproduction Tuff Wheel mounting adapter and horn center caps for various 1970-76 A, B, and E-body models equipped with the optional Tuft Steering wheel. Horn contact assembly with horn cap retainer and Tuft wheel-to-spacer mounting nuts are available separately.

Steering Wheel Adapter/Spacer

MW799 1970-76 A & B-bodies only	149.99 ea
Universal Horn Cap	
MW930 1970-76 without logo	34.99 ea
Horn Contact with Horn Cap Retainer	
MW931 1970-76 horn contacts	34.99 ea
Mounting Nuts - Steering Wheel to Spacer	
6029392 1970-76 mounting nuts	1.99 ea

Horn Components



1970-76 Tuff Wheel Steering Wheel Sets

Reproduction Tuff Wheel 14" steering wheels for 1970-76 models equipped with Tuff Wheel style adapter. Features molded grip with simulated grain and stitching. Includes steering wheel, center horn pad, and horn contact with plastic horn cap retainer.
Note: Requires original "Tuff Wheel" style spacer/adaptor (not included) for installation.

Tuff Wheel w/Barracuda Cap

Barracuda, "Cuda
MW801 1970-74 brushed finish 389.99 ea

Tuff Wheel w/Plain Cap

A, B and E Body
MW752 1970-76 brushed finish 209.99 set
MW753 1970-76 chrome finish 209.99 set

1970-76 Leather 15" Tuff Wheel

Aftermarket Tuff Wheel steering wheels for 1970-76 A, B, C and E-Body models. Features polished stainless steel spokes with a leather grip in your choice of black, blue, tan or red.

Note: Requires original "Tuff Wheel" style spacer (not included) for installation.



MN8052A 1970-76 black 184.99 ea
MN8052B 1970-76 blue 214.99 ea
MN8052C 1970-76 tan 214.99 ea
MN8052D 1970-76 red 214.99 ea

Flaming River 14" Tuff Wheel

The Flaming River Tuff Wheel is a 14-inch diameter laser cut stainless steel steering wheel with a black molded grip. Steering wheel adapter, sold separately, is designed specifically to fit Mopar vehicles equipped with a Flaming River steering column. Must use stock Tuff Wheel spacer to mount wheel to a stock Mopar steering column. A horn button is included with each wheel.

Available in your choice of polished or satin finish.
Note: Must use adaptor for Tuff Wheel to mount to Flaming River column. Sold separately.

Steering Wheels with Horn Button
MW714 polished finish 359.99 ea
MW715 satin finish 324.99 ea

Steering Wheel Mounting Adaptor
MW722 for Flaming River column 104.99 ea



Tuff Wheel 14" Leather Steering Wheel

This aftermarket wheel is similar to the Tuff Wheel Chrysler offered in the late 60's. This wheel is a great choice for vehicles that were not originally equipped with the Tuff Wheel. Features a matte nickel finish, an original style horn button and includes a dual bolt pattern (one for a direct replacement on the original tuff wheel style spacer and one for an installation kit for a non-tuff wheel column). The black leather grip features the baseball type stitch of the 1974 and later versions. Measures 14" in diameter with a 1-1/2" dish.
MW776 black leather 219.99 ea



Tuff Wheel 15" Walnut Steering Wheel

Similar to the Tuff Wheel Chrysler offered in the late 60's, this wheel is a great choice for vehicles that were not originally equipped with the Tuff Wheel. Features a matte nickel finish, an original style horn button and has a dual bolt pattern (one for a direct replacement on the original tuff wheel style spacer and one for an installation kit for a non-tuff wheel column). The hardwood walnut finish grip has a rich one piece look without the rivets. Measures 15" in diameter with a 1-3/4" dish.
MW774 walnut finish grip 179.99 ea



Tuff Wheel 15" Foam Steering Wheel

Similar to the Tuff Wheel Chrysler offered in the late 60's, this wheel is a great choice for vehicles that were not originally equipped with the Tuff Wheel. Features a matte nickel finish, an original style horn button and includes a dual bolt pattern (one for a direct replacement on the original tuff wheel style spacer and one for an installation kit for a non-tuff wheel column). The thick foam grip wheel measures 15" in diameter with a 2-1/2" dish.
MW775 thick foam grip 119.99 ea



1970-71 Rim Blow Steering Wheel Components

Reproduction horn caps, spacer/crush-can, and mounting hardware for the optional S83 Rim Blow steering wheel. These parts are OE for 1970-71 Barracuda, Challenger and Challenger T/A models equipped with the rare optional S83 rim blow wheel. The spacer/crush-can is OE to mount the rim blow wheel on 1970-74 E-Body vehicles. Also fits all other E-Body steering wheels including the 1972-74 two-spoke steering wheel.
2950812 1970-71 spacer/crush-can 99.99 ea
ME8130 1970 Barracuda cap 199.99 ea
ME8139 1970 Challenger cap 99.99 ea
ME8136 1970-71 plain cap 99.99 ea
6029392 1970-74 3 mounting nuts 1.99 ea



3 Styles to Choose From



1970-71 Rim Blow Steering Wheels

OE's reproduction of the 1970-71 rim blow steering wheel. Manufactured to exact original specifications, this wheel features a simulated wood grain look for an authentic OE appearance. Correct for 1970-71 models originally equipped with S-83 rim blow steering wheel option. Fits 1970-74 E-Body models.
Note: No further discounts apply on kits.

Individual Components

E-Body
4020FTX 1970-71 steering wheel 464.99 ea
ME8130 1970 Barracuda cap 199.99 ea
ME8139 1970 Challenger cap 99.99 ea
ME8136 1970-71 plain cap 99.99 ea
2950812 1970-71 spacer/crush can 99.99 ea
6029392 1970-76 wheel to spacer nut 1.99 ea

Buy the Kit and Save!

Kits include the wood grain steering wheel, horn cap pad, horn cap adaptor and the horn cap emblem.
Barracuda
ME1861 1970 w/Barracuda cap 603.99 kit
Challenger
ME1862 1970 w/Dodge cap 599.99 kit
E-Body
ME1860 1971 w/Plain cap 599.99 kit

NRG Steering Wheels

Short Hub Adapter **New!**

This short hub unit was designed to mount an aftermarket steering wheel/quick release combination close to the original orientation. Manufactured from the highest quality aluminum using a solid, one-piece design for maximum strength and durability.

Note: Must use with one of our Quick Release or Tilt systems.

152780 black..... 129.99 ea



Generation 2.0 Quick Release System

These 2.0 quick-release units feature many options that conventional Ball-Lock quick release systems do not offer, such as specially designed raised sections to protect hub stretches and a self-locking mechanism. These units are manufactured from highest quality aircraft aluminum with style and function that are designed to last. Available in black with a carbon fiber ring or in a variety of other colors with titanium chrome ring.

Note: Must use in conjunction with the Short Hub Adapter.

With Carbon Fiber Ring
152781C black..... 149.99 ea

With Titanium Ring
152782BK black..... 129.99 ea
152782GM gun metal..... 129.99 ea
152782GL silver..... 129.99 ea



Generation 2.8 Quick Release System

The Gen 2.8 Quick Release provides all the benefits of the 2.0 Generation Systems ball-locking quick release system with the added benefit of an upgraded Diamond Cut flared ring. This provides leverage and grip for the pull ring allowing much easier release of the steering wheel. Perfect for race applications where gloves are required. Choose from a selection of colors.

Note: Must use in conjunction with the Short Hub Adapter.
152784BK black..... 154.99 ea
152784GM gun metal..... 154.99 ea
152784GL silver..... 154.99 ea



1/2" Steering Wheel Spacers **New!**

Bring your steering wheel closer with this 1/2" spacer. Manufactured from CNC machined aluminum with counter sunk mounting holes to the hub, and a universal 6 bolt mounting pattern.

152779B black..... 24.99 ea
152779G silver..... 24.99 ea



Quick Tilt/Lock System **New!**

By allowing the steering wheel to tilt out of the way in one quick motion and combining a patented locking system to secure the wheel once the tilt is engaged, this system provides an added layer of anti-theft security without sacrificing convenience.

Note: Requires short hub adapter. Not compatible with quick lock or quick release units.

152772B black..... 259.99 ea
152772G silver..... 259.99 ea



NRG's Steering Wheel Adapter System:

NRG's modular steering wheel adapter system lets you choose the level of security for your classic vehicle. Pick from a quick release system that removes the steering wheel, a tilt-lock that unlinks the wheel from the column, or for total vehicle security use the Quick Lock system to prevent a would-be thief from placing a steering wheel onto the hub and driving away.

short hub adapter

quick lock unit

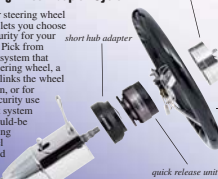

removable steering wheel

NRG steering wheel

NRG

- Manufactured from the highest quality aircraft aluminum.
- All Quick Release units feature a ball locking mechanism.
- Will work with all 1961-76 Mopar columns.
- Compatible with all Flaming River and Thidit Columns.



NRG Quick Lock System

A perfect complement to the Quick Release Systems, these units quickly and easily disable the steering hub by preventing the placement of a steering wheel onto the hub. Manufactured from solid steel and utilizing a Ball-Lock design and key mechanism. Available in various color finishes.

Note: Must use with either the 2.0 or the 2.8 quick release system.

152785GM gun metal..... 124.99 ea
152786GB gloss black..... 119.99 ea
152786GL polished..... 119.99 ea
152786MB matte black..... 119.99 ea



152786GL



standard woodgrain
152773B



racing style woodgrain
152776C



formula style woodgrain
152774B

NRG Rim Sport Style Wheel **New!**

NRG Rim Sport series wheel is manufactured from high quality materials, providing the feel of smooth luxurious wood. Polished aluminum center spokes and the old school brushed metal feel. Mounts to any six bolt hub or quick release unit and measures 14-1/4" in diameter, and 1-1/2" deep.

152778 6 bolt..... 199.99 ea



NRG Comfort Steering Wheel **New!**

The NRG comfort grip steering wheel is manufactured from high quality materials with a sophisticated design to provide luxurious black wood and the elegance of chrome center spokes.

Will bolt up to any six bolt hub or quick release unit. Measures 14" in diameter, and 2" deep.
152777 6 bolt..... 149.99 ea



NRG Woodgrain Steering Wheels

Add a traditional look to your interior with these 6-bolt woodgrain steering wheels from NRG. Mounts to any six bolt hub or quick release unit. Choose from standard GT-style, Formula style, or Racing Style woodgrain wheels. Each features a 13" diameter wheel. Racing and Formula style wheels measure 1-1/2" deep, while the standard wheel measures 1-3/4" deep.

Standard Woodgrain Wheels
152773B matte black center..... 159.99 ea
152773C chrome center..... 159.99 ea
Racing Style Woodgrain Wheels
152776B matte black center..... 159.99 ea
152776C chrome center..... 159.99 ea
Formula Style Woodgrain Wheels
152774B matte black center..... 159.99 ea
152774C chrome center..... 159.99 ea



NRG Steering Wheel Replacement Screws

Replacement mounting screw set for all NRG steering wheels. 6 piece set. Includes hex key.
152775 6 bolt M5-8.0 screws... 5.99 set

Steering Wheels & Horns



Classic Series Wheel Horn Buttons

These steering wheel horn buttons are optional for the Classic Series wheels. These different button styles feature a bright chrome steel button, a matte black button or a raw billet housing which include a logo insert.

Note: *No further discounts apply.

Bright Chrome	
MW781 MOPAR logo.....	14.99 ea
MW782 Pentastar logo.....	14.99 ea
MW783 Plymouth logo.....	14.99 ea
Black Luster	
MW784 MOPAR logo.....	14.99 ea
MW785 Pentastar logo.....	14.99 ea
Billet	
MR104* Mopar logo.....	49.99 kit
MR105* Pentastar logo.....	49.99 kit
MR106* Plymouth logo.....	49.99 kit



Signature Series Wheel Horn Buttons

These steering wheel horn buttons are optional for the Signature Series wheels. The button features a matte black button with a logo insert.

MW786* Mopar logo.....	19.99 ea
MW787* Pentastar logo.....	19.99 ea
MW788* Plymouth logo.....	19.99 ea



Classic Series Walnut Finish Steering Wheel Kits

This Walnut Finish Steering Wheel features hand-polished hardwood walnut finish and anodized aluminum rivet construction. 3-spoke wheel measures 13-1/2" diameter with a 3-3/4" dish. Includes a brilliant chrome finish. Each kit includes walnut wood steering wheel, installation kit and plain chrome horn cap as shown. Applications are available for a variety of 1961-74 A-Body and B-Body vehicles with standard column.

Note: No further discounts apply.

A-Body, B-Body with Standard Column	
MR100 1961-66.....	134.99 kit
MR101 1967.....	134.99 kit
MR102 1968-69.....	134.99 kit
MR103 1970-74.....	134.99 kit



1961-74 Steering Wheel Installation Sets

These installation sets are designed to install a three bolt aftermarket steering wheel or an aftermarket Tuff Wheel to your original Mopar steering column. MW777 1961-66 all standard column... 29.99 set
MW778 1967 all standard column... 29.99 set
MW779 1968-69 A.B w/std column... 29.99 set
MW780 1970-74 A.B.E w/std column... 29.99 set

Classic Steering Wheel Raw Billet Housing

This billet adaptor is the base for the horn button used with the Grant Classic Series steering wheel. This is the housing only and must add horn buttons. Available with Mopar, Pentastar or Plymouth logo.

MW796 raw billet housing only.....	29.99 ea
------------------------------------	----------

Classic Series Walnut Finish Steering Wheel

This Walnut Finish Steering Wheel features a hand-polished hardwood walnut finish and anodized aluminum rivet construction. 3-spoke wheel measures 13-1/2" in diameter with a 3-3/4" dish. Includes walnut wood steering wheel and a plain chrome horn button as shown.

MW773 Classic Series walnut wheel.... 119.99 ea



Steering Wheel Pullers

Great item to have when replacing your OEM or replacement steering wheel. Can be used for almost any models steering wheel. Allows easy removal of steering wheel. Complete instructions included.

K212 standard puller.....	9.99 ea
X229J professional puller.....	17.99 set



1966-76 Reproduction Horns

Reproduction horn assemblies for 1966-76 Mopar models. Each horn assembly is manufactured to factory specifications including correct OEM markings, and designed to produce the correct pitch notes as original. Mounting may vary from original on some models. Pre-packaged in OER box. Officially licensed by Mopar.

Note: Not for full size models.

MH108 1966-76.....	129.99 set
--------------------	------------



1968-74 Road Runner Horns

Replacement "beep-beep" horn speaker for all 1968-74 Road Runner models. Features the correct length mounting bracket, and is finished in the correct black or purple color. The decal is also applied as original.

Purple Color 1971-74 Horns	
MB1876 1969-70 3-3/8" bracket.....	94.99 ea
MB1877 1971-72 1-1/2" bracket.....	109.99 ea
Black Road Runner Horns	
MB1874 1968 3-3/8" bracket.....	84.99 ea
MB1875 1968 1-1/2" bracket.....	79.99 ea
MB1874 1973-74 3-3/8" bracket.....	84.99 ea
MB1875 1973-74 1-1/2" bracket.....	79.99 ea
Road Runner Horn Decal	
MB280971 1969-74.....	6.99 ea

Console Components



MA598



MA682



MA680



MA681

1966-76 A-Body Console Components

Repair the center console in your 1966-76 A-Body vehicle with a variety of brand new console components. Components are available for 1966-76 A-Body models including 1966 Valiant Signet, 1966-69 Barracuda, 1966-70 Dart, 1971-72 Demon, 1973-76 Dart Sport and 1970-76 Duster.

Complete 3 Piece Console Trim Set

Buy the set and save! This convenient 3 piece Set contains the top plate, console door and ashtray door. Sets are available in your choice of chrome or woodgrain to fit vehicles equipped with 4-speed or automatic.

Console Top Plate, Door and Ashtray Door Set

MA592	1966-69	chrome, all w/MT	514.99	set
MA593	1966-69	chrome, all w/AT	514.99	set
MA594	1969-76	woodgrain, all w/MT	514.99	set
MA595	1969-76	woodgrain, all w/AT	609.99	set

Console Components

Console Top Plate

MA596	1966-69	chrome, all w/MT	344.99	ea
MA597	1966-69	chrome, all w/AT	344.99	ea
MA598	1969-76	woodgrain, all w/MT	344.99	ea
MA599	1969-76	woodgrain, all w/AT	344.99	ea

Console Door

MA680	1966-69	chrome	184.99	ea
MA681	1969-76	woodgrain	184.99	ea

Ashtray Door

MA682	1966-76	all, chrome	78.99	ea
-------	---------	-------------	-------	----

Shifter Lens

MD4004	1966-76	automatic	31.99	ea
--------	---------	-----------	-------	----

Shifter Slide

MD4005	1966-76	automatic, black	19.99	ea
--------	---------	------------------	-------	----



MA590

1966-76 A-Body Console Woodgrain Inserts

Repair the woodgrain on your 1966-76 A-Body console with a brand new set of replacement woodgrain inserts. Applications are available for a variety of 1966-76 A-Body models including 1969 Barracuda, 1969-76 Dart, 1970-71 Demon, 1972-76 Dart Sport and 1970-76 Duster. Made in the USA.

Note: Woodgrain console inserts were part of an optional decor package in 1969, but the set will fit 1966-69 console plate and lid.

MA588	1966-69	automatic	19.99	ea
MA589	1966-69	manual	19.99	ea
MA590	1970-76	automatic	19.99	ea
MA591	1970-76	manual	19.99	ea



MA684801

Loop Colors for 1973 Models

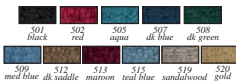

501 black 502 red 503 aqua 507 dk blue 508 dk green

509 med blue dk saddle maroon 513 teal blue 515 sandalwood gold 519 520

Cut Pile Colors for 1974-76 Models

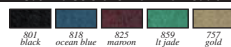

801 black 818 ocean blue 825 maroon 859 lt jade 757 gold

1966-76 A-Body Console Carpet Set

Replace the discolored, missing or deteriorated console carpeted side panels in your 1966-76 A-Body vehicle with a brand new carpet set. Applications are available for 1966-76 A-Body automatic models equipped with optional center console. Made in USA.

Note: Please specify color when ordering.

Console Carpet Set

MA683	1966-73	loop	82.99	ea
MA684	1974-76	cut pile	82.99	ea



MBS40



MBS48



MBS45

1966-76 B-Body Console Components

Repair the center console in your 1966-76 B-Body with a variety of brand new console components from Classic Industries®. Components are available for the consoles of 1966-76 B-Body hardtop and convertible models.

Complete 5 Piece Console Trim Set

Buy the set and save! This convenient 5 piece Set contains the top plate, console door, hinge, glove box trim and rear trim cap. Available for 4-speed or automatic.

Console Top Plate, Door and Trim Set

MB533	1966-68	chrome, w/MT	819.99	set
MB534	1966-68	chrome, w/AT	729.99	set
MB535	1969-70	woodgrain, w/MT	819.99	set
MB536	1969-70	woodgrain, w/AT	729.99	set

Console Components

Console Top Plate

MB537	1966-68	chrome, all w/MT	399.99	ea
MB538	1966-68	chrome, all w/AT	394.99	ea
MB539	1969-70	woodgrain, all w/MT	419.99	ea
MB540	1969-70	woodgrain, all w/AT	394.99	ea

Console Door

MB541	1966-68	chrome	194.99	ea
MB542	1969-70	woodgrain	194.99	ea

Console Box Top Rear Trim

MB543	1966-68	chrome	94.99	ea
MB544	1969-70	woodgrain	99.99	ea

Console Rear Trim and Bracket

MB545	1966-70	rear trim, chrome	164.99	ea
MB546	1966-70	trim mounting bracket	84.99	ea

Console Door Mounting Hardware

MP14052	1966-70	mounting strips and lock catch bracket	29.99	ea
---------	---------	--	-------	----

Console Door Hinge

MB547	1966-70	auto/4-speed	41.99	ea
-------	---------	--------------	-------	----

Console Mounting Brackets

MB548	1966-70	4-speed trans	84.99	set
MB549	1966-70	automatic trans	164.99	set

Console Lock

MB2045	1966-70	for console door	49.99	ea
--------	---------	------------------	-------	----

Shifter Lens

MD4004	1966-70	automatic	31.99	ea
--------	---------	-----------	-------	----

Shifter Slide

MD4005	1966-70	automatic, black	19.99	ea
--------	---------	------------------	-------	----

B DASH & CONSOLE COMPONENTS

Console Components



AUTHENTIC
 REPRODUCTION

DEF

AUTHENTIC
 REPRODUCTION



Made in USA

1966-70 B-Body Console Side Trim

Reproduction console side trim for 1966-70 B-Body models. Manufactured in aluminum as original and triple chrome plated for a deep, smooth finish. Fits 1966-70 Charger, Coronet, Superbee, GTX, Satellite, Road Runner and Belvedere. Made in the USA.

MB15104 1966-70 automatic	119.99 pr
MB15105 1966-70 4-speed	119.99 pr

1967-70 B-Body Console

Replace the cracked or broken plastic center console in your 1967-70 B-Body vehicle with a brand new injection molded console body. Original door, trim plates, moldings, bull's-eye lamps and hardware must be re-used. Fits 1967-70 B-Body hardtop and convertible models equipped with optional center console.

MB1701 1967-70 automatic	274.99 ea
MB1702 1967-70 manual	289.99 ea



MB557

1968-70 B-Body Console Inserts

Made in USA

Repair the woodgrain on your 1968-70 B-Body console with a brand new set of replacement woodgrain inserts. These die-cut vinyl decal sets are an inexpensive way to bring your console plates back to life. Applications are available for 1968-70 B-Body hardtop and convertible models equipped with an optional center console. Made in the USA.

MB557 1968-70 automatic	19.99 set
MB558 1968-70 4-speed	19.99 set



Loopcarpet
 AUTO INTERIORS LTD.

MB52501

Loop Carpet Colors

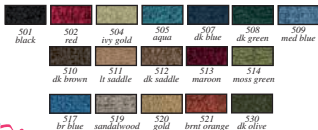

Made in USA

1966-70 B-Body Console Carpet Set

The console on 1966-70 B-Body models originally came covered with carpeted panels in certain areas to help the console blend with the floor of the vehicle. We offer this replacement console carpet set in a variety of colors to perfectly match our loop passenger compartment carpet sets. Applications are available for a variety of 1966-70 B-Body hardtop and convertible models equipped with optional center console and automatic or 4-speed transmission. Please specify color when ordering. Made in USA.

Note: Will not fit 1966-67 Charger.

MB552 1966-70 automatic	44.99 ea
MB553 1966-70 4-speed	74.99 ea



1966-70 B-Body Console Side Cover

The side cover is located on the front driver side portion of the 4-speed center console to fill the area between the floor and console. We offer an extremely durable fiberglass cover or an inexpensive ABS plastic cover that will last much longer than fiberboard. Applications are available for 1966-70 B-Body hardtop and convertible models.

Console Side Cover, Fiberglass

MB554 1966 Charger w/MT	94.99 ea
MB555 1966-70 all w/MT (exc Charger)	74.99 ea

Console Side Cover, ABS Plastic

MB556 1966-70 all w/MT (exc Charger)	74.99 ea
--------------------------------------	----------

DEF AUTHORIZED

AUTHENTIC
 REPRODUCTION



1964-70 B-Body Console Lamps & Lenses

These bull's-eye console lamps are mounted on each side of the center console to illuminate the front footwell of the vehicle. Fits 1964-70 B-Body hardtop and convertible models equipped with optional center console.

MB896 1964-70 complete lamp set	44.99 pr
MB897 1964-70 lens set	6.99 pr



1964-65 B-Body Console Tachometer

This new tachometer features an authentic appearance, but is internally updated with modern electronic technology that allows it to work with many different types of ignition systems including breaker point, electronic ignition and even MSD or Petronix ignition systems. These features make it the ultimate bolt-in solution to your missing or inoperative original tach. For 1964-65 B-Body models.

MB493 1964-65	241.99 ea
---------------	-----------

LOKAR Accessories



BAG6145
BAG6147
BAG6146

1967-69 Dart, Barracuda Billet Throttle Assemblies and Pedals

These 1967-69 Dart, Barracuda billet aluminum throttle pedal assemblies are made to bolt into the factory mounting location on the firewall without any drilling or modification. Designed with an internal spanner nut to maintain perfect pedal tension, this throttle assembly eliminates the possibility of excess slop in the pedal. Brake and clutch pedal pads are fashioned after their OEM counterparts and feature hidden screws that allow them to bolt to the steel pedal with a clean finish. Offered in brushed or black finish with rubber inserts for style and functionality.

Brushed		
BAG6145	accelerator pedal assembly.....	169.99 ea
BAG6146	brake & clutch pads.....	89.99 pr
BAG6147	automatic trans brake pad.....	59.99 ea
Black		
BC6145	accelerator pedal assembly.....	164.99 ea
BC6146	brake & clutch pads.....	89.99 pr
BC6147	automatic trans brake pad.....	59.99 ea



Eliminator Floor Mount Gas Pedals

The Eliminator floor mount gas pedal is precision crafted from billet aluminum and designed to eliminate routing cables through the firewall. It includes an adjustable aluminum splined shaft and stainless steel under-the-floor cable mounting bracket. Can be mounted in multiple positions for various floor and toe board angles, while pedal travel stops are built in. Pedal floor spacers are recommended when installing the pedal on vehicles with thick carpet or under carpet padding.

Important: Requires a Car-To-Fit Lokar throttle cable.

FM6097	w/ball milled pad.....	149.99 ea
FM6098	polished w/rubber inserts.....	149.99 ea
FM6099	black w/rubber inserts.....	149.99 ea
GPS6016	pedal floor spacer, aluminum.....	31.99 ea
GPS6019	pedal floor spacer, black.....	31.99 ea



FR6115 FR6116 FR6117

Billet Adjustable Foot Rest

Fabricated from billet aluminum, these adjustable precision foot rests feature universal mounting and adjustable angles for your ultimate comfort. Available ball milled or with rubber inserts. Includes stainless steel mounting hardware. Measures 1-1/2" x 4".

FR6115	w/ball milled pad.....	64.99 ea
FR6116	polished w/rubber inserts.....	64.99 ea
FR6117	black w/rubber inserts.....	64.99 ea

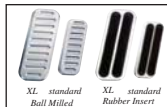

XL standard Ball Milled XL standard Rubber Insert



BAG6001

Polished Aluminum Throttle Assemblies

Polished billet aluminum throttle assemblies are the first spring loaded pedals in the industry! These beautifully curved pieces are spring loaded like the OE design and feature a splined removable lower arm for versatility in mounting to the right or left of the bracket. The shaft and arm are combined in a one piece design that requires no pins. Matching billet aluminum brake pad mounts with a 1/2"-20 stud built into the back of the pad. Available in a standard size or extra large size. Pedal floor spacers are recommended when installing pedal on vehicles with thick carpet or carpet padding.

Throttle Assembly w/Ball Milled Pad		
BAG6001	standard, 1-1/2" x 4".....	139.99 ea
BFG6010	x-large 2" x 5".....	149.99 ea
Brake Pedal w/Ball Milled Pad		
BAG6002	standard, 3" x 2".....	44.99 ea
BFG6011	x-large, 3-3/4" x 2-3/4".....	49.99 ea
Dimmer Switch Pedal w/Ball Milled Pad		
BAG6003	21.99 ea
Throttle Pedal Floor Spacer		
GPS6014	billet aluminum.....	24.99 ea
Throttle Assembly w/Rubber Insert		
BAG6004	standard, 1-1/2" x 4".....	139.99 ea
BFG6012	x-large 2" x 5".....	149.99 ea
Brake Pedal w/Rubber Insert Pad		
BAG6005	standard, 3" x 2".....	49.99 ea
BFG6013	x-large, 3-3/4" x 2-3/4".....	49.99 ea
Dimmer Switch Pedal w/Rubber Insert Pad		
BAG6006	21.99 ea
Throttle Pedal Floor Spacer		
GPS6014	billet aluminum.....	24.99 ea



XL standard

SG6007

Chromed Steel Throttle Assemblies

The first spring loaded pedals in the industry! These chromed steel throttle assemblies are spring loaded like the OE design and feature a removable, splined lower arm for versatile mounting to the right or left of the bracket mount. Matching chromed steel brake pedal pad mounts with a 1/2"-20 stud built into the back of it. Available in standard or extra large pedal sizes. A matching dimmer switch pad also available. Pedal floor spacers are recommended when installing on vehicles with thick carpet or carpet padding.

Throttle Assembly w/Rubber Insert		
SG6007	standard size, 1-1/2" x 4".....	99.99 ea
SG6016	X-Large, 2" x 5".....	109.99 ea
Brake Pedal w/Rubber Insert Pads		
SG6008	standard size, 3" x 2".....	49.99 ea
SG6017	X-Large, 3-3/4" x 2-3/4".....	51.99 ea
Dimmer Switch w/Rubber Insert Pads		
SG6009	21.99 ea
Throttle Pedal Floor Spacer		
GPS6015	chrome.....	24.99 ea



XL standard Rubber Insert

BAG6004

Black Billet Aluminum Throttle Assemblies

Gleaming polish not your style? Then take a look at these stealthy black billet spring-loaded throttle assemblies that feature a removable lower arm splined for versatile mounting to either the right or left of the bracket. The shaft and arm are machined together into a one piece design requiring no pins. Matching black billet brake pad mounts with a 1/2"-20 stud built into the back of the pad. Available in standard or extra large sizes. Pedal floor spacers are recommended when installing pedal on vehicles with thick carpet or carpet padding.

Throttle Assembly w/Rubber Insert		
BC6004	standard size, 1-1/2" x 4".....	139.99 ea
BG6012	x-large, 2" x 5".....	149.99 ea
Brake Pedal w/Rubber Insert Pad		
BG6005	standard size, 3" x 2".....	49.99 ea
BG6013	x-large, 3-3/4" x 2-3/4".....	49.99 ea
Dimmer Switch Pedal w/Rubber Insert Pad		
BG6006	21.99 ea
Throttle Pedal Floor Spacer		
GPS6014B	black.....	24.99 ea

Pedal Components



Detail



1962-65 Accelerator Pads

Replacement accelerator pedal for 1962-65 Dodge and Plymouth models. Manufactured with steel core and studs.

MD2169 1962-65 all..... 49.99 ea



MA2214



MA2215



1967-70 A-Body Accelerator Pads

Accelerator pads for 1967-70 A-Body models. Offered with or without the stainless bezel. Includes hardware.

MA2214 1967-68 without bezel..... 41.99 ea
MA2215 1967-68 with bezel..... 55.99 ea
MA2216 1969-70 without bezel..... 44.99 ea
MA2217 1969-70 with bezel..... 57.99 ea



Detail



1966-70 B-Body Accelerator Pad

Accelerator pedal for 1966-70 B-Body models. Manufactured with a steel core and includes studs for mounting.

MB327 1966-70..... 44.99 ea



MD2170



MD2144



1971-72 A/B-Body Accelerator Pads

This accelerator pedal kit is for A-Body and B-Body models. Offered with or without the stainless bezel. Includes hardware.

MD2170 1971-72 without bezel..... 44.99 ea
MD2144 1971-72 with bezel..... 59.99 ea



ME1613



ME1614



1970-74 E-Body Accelerator Pads

OER® reproduction accelerator pedal for 1970-74 E-Body models. Manufactured with steel core and studs as original. Offered with or without the stainless bezel. Accelerator pedal includes installation hardware and is available with or without the stainless bezel. Hardware also available separately.

Accelerator Pads
ME1612 1970 without bezel..... 41.99 ea
MD2170 1971-72 without bezel..... 44.99 ea
MD2144 1971-72 with bezel..... 59.99 ea
ME1613 1973-74 without bezel..... 41.99 ea
ME1614 1973-74 with bezel..... 59.99 ea

Hardware Sets
MD2608 1971-72 hardware..... 9.99 set
MD2609 1973-74 hardware..... 9.99 set



MA2468



MD1620

1966-74 Accelerator Pedal Bezel

Replacement accelerator pedal bezel for various 1966-74 models. Manufactured to original specifications and features the correct stainless steel finish.

MA2468 1967-70 A-Body..... 19.99 ea
MD1620 1971-72 A-Body..... 19.99 ea
MB3275 1966-70 B-Body..... 19.99 ea
MD1620 1971-72 B-Body..... 19.99 ea
MD1620 1973-74 E-Body..... 19.99 ea



1967-70 B-Body Accelerator Pedal Roller

This replacement accelerator pedal roller for all 1966-70 B-Body models features the correct steel insert, as original.

MB1880 1966-70 B-Body..... 17.99 ea



1967-70 Accelerator Pedal Seal

Accelerator pedal seal for 1966-70 B-Body models.

MB2243 1966-70..... 2.99 ea



1962-66 Brake Pedal Pad

Brake pedal pad for various 1962-66 Dodge and Plymouth models with automatic transmission. Measures 6" x 2".

MD2188 1963-66 A-Body..... 14.99 ea
MD2188 1962-65 B-Body..... 14.99 ea



1966-70 Brake Pedal Pad

Brake pedal pad for 1966-70 Dodge and Plymouth models with automatic transmission. Measures 6-1/2" x 2-3/8".

MD2189 1966-70..... 12.99 ea



1970-71 B & E-Body Brake Pedal Pad

Correct replacement brake pedal pad for 1970-71 B and E-Body models equipped with automatic transmission.

MN1868 1971 B-Body..... 12.99 ea
MN1868 1970-71 E-Body..... 12.99 ea

Pedal Components



1962-65 Brake/Clutch Pedal Pad

Brake and clutch pedal pad for 1962-65 Dodge and Plymouth models with a manual transmission.

MD2190 1962-65..... 9.99 ea



1966-70 Brake/Clutch Pedal Pad

Brake and clutch pedal pad for 1966-70 Dodge and Plymouth models with a manual transmission. Measures 3-3/4" x 2-1/4".

MD2191 1966-70..... 12.99 pr



1970-72 Brake/Clutch Pedal Pad

Brake and clutch pedal pads for 1970-72 Dodge and Plymouth B-Body and E-Body models with manual transmission.

MD2192 1970-72..... 11.99 ea



MD1618



MD1619

1966-76 Automatic Brake Pedal Bezel

Replacement pedal bezel for various 1966-76 models with automatic transmission. Features correct stainless steel finish as original.

MD1618 1966-70 A/B-Body..... 17.99 ea
 MD1619 1972-76 A-Body..... 17.99 ea
 MD1619 1973-76 B-Body..... 17.99 ea
 MD1619 1973-74 E-Body..... 17.99 ea



1966-70 Clutch & Brake Pedal Bezel

Replacement clutch and brake pedal bezel for all 1966-70 A & B-Body models. Features the correct stainless steel finish.

MD1612 1966-70..... 24.99 pr



1962-65 Parking Brake Pedal Pad

Parking brake pedal pad for 1962-65 Dodge and Plymouth models.

MD2193 1962-65..... 9.99 ea



1966-70 Parking Brake Pedal Pad

Park brake pedal pad for 1966-70 Dodge and Plymouth models with automatic transmission. Measures 1-5/8" x 2-3/8".

MD2194 1966-70..... 6.99 ea



ME1615



ME1616



1970-74 Parking Brake Pedal Pad

Park brake pedal pad for 1970-74 E-Body models. Measures 1-5/8" x 2-15/16".

ME1615 1970-74 black..... 7.99 ea
 ME1616 1970-74 gray..... 11.99 ea



1966-74 Parking Brake Pedal Bezel

Replacement parking brake pedal bezel for various 1966-72 B-Body and 1970-74 E-Body models. Features the correct stainless steel finish.

MD1617 1966-72 B-Body..... 9.99 ea
 MD1617 1970-74 E-Body..... 9.99 ea

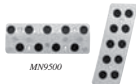

MN9500



MN9501



MN9506

Custom Aluminum Pedal Covers

Dress up your interior with these high-quality brushed aluminum pedal covers. These covers use a two-piece design that bolts through the existing pedals, much safer than clamp-on pedal covers. Includes pedals, hardware, and instructions.

A-Body

Automatic Transmission
 MN9500 1967-70..... 129.99 set
 MN9502 1971-72..... 129.99 set
 MN9504 1973-76..... 129.99 set

Manual Transmission

MN9501 1967-70..... 139.99 set
 MN9503 1971-72..... 139.99 set
 MN9505 1973-76..... 139.99 set

B-Body

Automatic Transmission
 MN9506 1966-70..... 139.99 set
 MN9510 1971-72..... 139.99 set
 MN9512 1973-74..... 139.99 set

Manual Transmission

MN9507 1966-70..... 149.99 set
 MN9511 1971-72..... 149.99 set
 MN9513 1973-74..... 149.99 set

E-Body

Automatic Transmission
 MN9508 1970..... 139.99 set
 MN9510 1971-72..... 139.99 set
 MN9512 1973-74..... 139.99 set

Manual Transmission

MN9509 1970..... 149.99 set
 MN9511 1971-72..... 149.99 set
 MN9513 1973-74..... 149.99 set

Brake Cables and Components

Available in Original Material or Long Lasting Stainless Steel!

Dodge & Plymouth Park Brake Cables and Cable Sets

Parking brake cables and components for 1963-74 model vehicles. Available in original material or stainless steel; these park brake components are available individually or as a complete set. Please add the suffix to the end of the part number for the finish of your choice. Made in USA.

Important: All our complete sets will include all the necessary individual hardware pieces for that specific set. Individual hardware pieces also sold individually.
Note: A-Body and E-Body cables came from the factory two ways: 2 short rear cables and intermediate, or 1 short and 1 long cable.



ME1634B detail

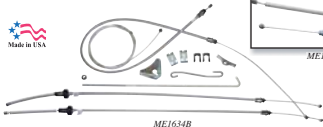

ME1634B

A-Body Park Brake Cables

1963-74 A-Body Brake Cables-Original Material

1963-66			
MA1563A	1963-66	front cable	59.99 ea
MA1564A	1963-66	intermediate cable-Dodge	17.99 ea
MA1566A	1963-66	rear cable	54.99 ea
1967-74 w/o Intermediate Cable			
MA1569A	1967-74	front cable	59.99 ea
MA1570A	1967-74	rear cable (short cable)	54.99 ea
MA1571A	1967-74	rear cable (long cable)	64.99 ea
1967-74 w/Intermediate Cable			
MA1573A	1967-74	front cable	59.99 ea
MA1574A	1967-74	intermediate cable	17.99 ea
MA1575A	1967-74	rear cable	54.99 ea
Complete Set			
MA1567A	1963-66	Plymouth	149.99 set
MA1568A	1963-66	Dodge	149.99 set
Complete Set w/o Intermediate Cable			
MA1572A	1967-74		149.99 set
Complete Set w/Intermediate Cable			
MA1577A	1967-74		149.99 set

1963-74 A-Body Brake Cables-Stainless Steel

1963-66			
MA1563B	1963-66	front cable	64.99 ea
MA1564B	1963-66	intermediate cable-Dodge	24.99 ea
MA1566B	1963-66	rear cable	64.99 ea
1967-74 w/o Intermediate Cable			
MA1569B	1967-74	front cable	69.99 ea
MA1570B	1967-74	rear cable (short cable)	64.99 ea
MA1571B	1967-74	rear cable (long cable)	69.99 ea
1967-74 w/Intermediate Cable			
MA1573B	1967-74	front cable	69.99 ea
MA1574B	1967-74	intermediate cable	24.99 ea
MA1575B	1967-74	rear cable	64.99 ea
Complete Set			
MA1567B	1963-66	Plymouth	199.99 set
MA1568B	1963-66	Dodge	199.99 set
Complete Set w/o Intermediate Cable			
MA1572B	1967-74		199.99 set
Complete Set w/Intermediate Cable			
MA1577B	1967-74		199.99 set

B-Body Park Brake Cables

1963-74 B-Body Brake Cables-Original Material

1963-65			
MB2312A	1963-65	front cable	59.99 ea
MB2313A	1963-65	intermediate cable-Dodge	17.99 ea
MB2314A	1963-65	intermediate cable-Plymouth	17.99 ea
MB2315A	1963-65	rear cable	54.99 ea
1966-70			
MB2318A	1966-70	front cable	59.99 ea
MB2319A	1966-70	rear cable (short cable)	54.99 ea
MB2320A	1966-70	rear cable (long cable)	74.99 ea
1971-74			
MB2322A	1971-74	front cable	59.99 ea
MB2323A	1971-72	intermediate cable	24.99 ea
MB2324A	1973-74	intermediate cable	24.99 ea
MB2325A	1971-74	rear cable	54.99 ea
Complete Set			
MB2316A	1963-65	Plymouth	149.99 set
MB2317A	1963-65	Dodge	149.99 set
Complete Set w/o Intermediate Cable			
MB2321A	1966-70		149.99 set
Complete Set w/Intermediate Cable			
MB2326A	1971-72		149.99 set
MB2327A	1973-74		149.99 set

1963-74 B-Body Brake Cables-Stainless Steel

1963-65			
MB2312B	1963-65	front cable	64.99 ea
MB2313B	1963-65	intermediate cable-Dodge	24.99 ea
MB2314B	1963-65	intermediate cable-Plymouth	24.99 ea
MB2315B	1963-65	rear cable	64.99 ea
1966-70			
MB2318B	1966-70	front cable	69.99 ea
MB2319B	1966-70	rear cable (short cable)	64.99 ea
MB2320B	1966-70	rear cable (long cable)	84.99 ea
1971-74			
MB2322B	1971-74	front cable	64.99 ea
MB2323B	1971-72	intermediate cable	34.99 ea
MB2324B	1973-74	intermediate cable	34.99 ea
MB2325B	1971-74	rear cable	64.99 ea
Complete Set			
MB2316B	1963-65	Plymouth	199.99 set
MB2317B	1963-65	Dodge	199.99 set
Complete Set w/o Intermediate Cable			
MB2321B	1966-70		199.99 set
Complete Set w/Intermediate Cable			
MB2326B	1971-72		199.99 set
MB2327B	1973-74		199.99 set

E-Body Park Brake Cables

1970-74 E-Body Brake Cables-Original Material

1970-74 w/Intermediate Cable			
ME1629A	1970-74	front cable-'Cuda	64.99 ea
ME1630A	1970-74	front cable-Challenger	64.99 ea
ME1631A	1970-74	'Cuda intermediate cable (85")	17.99 ea
ME1632A	1970-74	Challenger intermediate cable (86")	17.99 ea
ME1633A	1970-74	rear cable, short	54.99 ea
1970-74 w/o Intermediate Cable			
ME1636A	1970-74	front cable-'Cuda	64.99 ea
ME1637A	1970-74	front cable-Challenger	64.99 ea
ME1638A	1970-74	rear cables-includes 1 short, 1 long	109.99 pr
Complete Set w/Intermediate Cable			
ME1634A	1970-74	'Cuda	149.99 set
ME1635A	1970-74	Challenger	149.99 set
Complete Set w/o Intermediate Cable			
ME1639A	1970-74	'Cuda	149.99 set
ME1640A	1970-74	Challenger	149.99 set

1970-74 E-Body Brake Cables-Stainless Steel

1970-74 w/Intermediate Cable			
ME1629B	1970-74	front cable-'Cuda	89.99 ea
ME1630B	1970-74	front cable-Challenger	89.99 ea
ME1631B	1970-74	'Cuda intermediate cable (85")	24.99 ea
ME1632B	1970-74	Challenger intermediate cable (86")	24.99 ea
ME1633B	1970-74	rear cable (short, vehicles w/intermed)	74.99 ea
1970-74 w/o Intermediate Cable			
ME1636B	1970-74	front cable-'Cuda	89.99 ea
ME1637B	1970-74	front cable-Challenger	89.99 ea
ME1638B	1970-74	rear cables-includes 1 short, 1 long	119.99 pr
Complete Set w/Intermediate Cable			
ME1634B	1970-74	'Cuda	199.99 set
ME1635B	1970-74	Challenger	199.99 set
Complete Set w/o Intermediate Cable			
ME1639B	1970-74	'Cuda	199.99 set
ME1640B	1970-74	Challenger	199.99 set

Brake Cables and Components

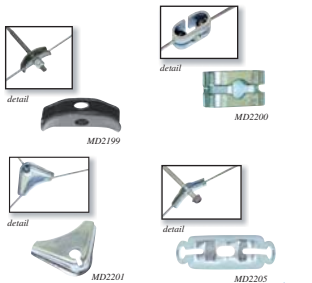

Park Brake Cable Hardware



Parking brake cable hardware to be used with parking brake cables for 1962-74 Mopar A, B and E-Body models. Listed below are the equalizers, connectors, hooks, clips, cable guides and more that are necessary to return your parking brake to good working order. Made in USA.

1962-74 A-Body Brake Cable Components

1962-66			
MD2199	1962-66	equalizer w/2 nuts.....	5.99 ea
MD2200	1962-66	intermediate to rear connectors - replacement ..	5.99 ea
MD2605	1962-66	intermediate to rear connectors - reproduction..	17.99 pr
MD2204	1962-66	cable clip - 2 required.....	2.99 ea
1967-74 w/o Intermediate Cable			
MD2204	1967-74	cable clip - 2 required.....	2.99 ea
MD2205	1967-74	cable equalizer (no intermediate)	9.99 ea
1971-74 w/Intermediate Cable			
MA1576	1971-74	long threaded hook.....	16.99 ea
MD2199	1971-74	equalizer w/2 nuts.....	5.99 ea
MD2200	1971-74	connectors (intermediate to rear).....	5.99 ea
MD2201	1971-74	cable guide (front to center).....	8.99 ea
MD2204	1971-74	cable clip - 2 required.....	2.99 ea

1962-74 B-Body Brake Cables-Components

1962-65			
MD2199	1962-65	equalizer w/2 nuts.....	5.99 ea
MD2200	1962-65	connectors (intermediate to rear) - replacement	5.99 ea
MD2605	1962-65	connectors (intermediate to rear) - reprodu.....	17.99 pr
MD2204	1962-65	cable clip - 2 required.....	2.99 ea
1966-70			
MD2204	1966-70	cable clip - 2 required.....	2.99 ea
MD2205	1966-70	cable equalizer (no intermediate)	9.99 ea
MB5058	1968-70	brake bracket.....	11.99 ea
MB5059	1968-70	rear brake cable bracket.....	9.99 ea
MB5060	1968-70	brake line support bracket.....	2.99 ea
1971-74			
MD2199	1971-74	equalizer w/2 nuts.....	5.99 ea
MD2200	1971-74	connectors (intermediate to rear).....	5.99 ea
MD2201	1971-74	cable guide (front to center).....	8.99 ea
MD2202	1971-74	short body/crossmount hook.....	9.99 ea
MD2203	1971-74	long threaded hook.....	19.99 ea
MD2204	1971-74	cable clip - 2 required.....	2.99 ea

1970-74 E-Body Brake Cable Components

Vehicles Equipped w/Intermediate Cable			
MD2199	1971-74	equalizer w/2 nuts.....	5.99 ea
MD2200	1971-74	connectors (intermediate to rear) - replacement	5.99 ea
MD2605	1971-74	connectors (intermediate to rear) - reprodu.....	17.99 pr
MD2201	1971-74	cable guide (front to center).....	8.99 ea
MD2202	1971-74	short body/cross-mount hook.....	9.99 ea
MD2203	1971-74	long threaded hook.....	19.99 ea
MD2204	1971-74	cable clip - 2 required.....	2.99 ea
Vehicles w/o Intermediate Cable			
MD2204	1970-74	cable clip - 2 required.....	2.99 ea
MD2205	1970-74	cable equalizer (no intermediate)	9.99 ea



Under-Dash Parking Brake Cables

Lokar connector cables are designed to mount directly to the under-dash, foot operated brake and connect with Lokar universal rear brake cables. These cut-to-fit 6' long cables are available with either a black or stainless steel housing.

EC8001	stainless steel housing.....	129.99 ea
EC8001B	black housing.....	84.99 ea

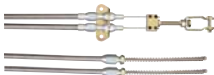

Universal Rear Parking Brake Cables

Lokar universal rear brake cables are designed to work with the Lokar Under-Dash foot operated brake cables. The outer housing is designed with a specially extruded liner for extended life of the cable and the stainless cable resists moisture. Features adjustable cable lock and clevis and come complete with two 8' cut-to-fit housings, cables, cable bracket and spacers. Available with either a black or stainless steel housing.

EC80	stainless steel housing.....	199.99 ea
EC80B	black housing.....	139.99 ea



Under-Dash Park Brake Pedal Assembly

This foot operated park brake assembly gives you ease of operation along with a clean, out of the way appearance. Available in 2 styles and 3 different finishes, these pedal assemblies feature dash-to-fire all adjustability, adaptable mounting location capability and hidden, heat treated gears and mechanisms for an uncluttered finish. They also include a rubber stop for quiet pedal return, as well as complete hardware and instructions. Connector cables sold separately.

Billet Aluminum

Solid Ball Milled Arm			
FB9000	w/ball milled pad.....	244.99 ea	
FB9001	w/rubber inserts in pad.....	244.99 ea	
CNC Cut-Out Arm			
FB9002	w/ball milled pad.....	244.99 ea	
FB9003	w/rubber inserts in pad.....	244.99 ea	

Chrome Billet Aluminum

Solid Ball Milled Arm			
FB9004	w/ball milled pad.....	299.99 ea	
FB9005	w/rubber inserts in pad.....	299.99 ea	
CNC Cut-Out Arm			
FB9006	w/ball milled pad.....	299.99 ea	
FB9007	w/rubber inserts in pad.....	299.99 ea	

Black Billet Aluminum

Solid Ball Milled Arm			
FB9001B	w/rubber inserts in pad.....	244.99 ea	
CNC Cut-Out Arm			
FB9003B	w/rubber inserts in pad.....	244.99 ea	

CLASSIC INDUSTRIES® ACCESSORIES



A



B



C



D



E



F



G



H

I

J

K



L

Classic Industries® logo is printed on the front left and sleeve of our t-shirts.

L. Classic Industries® Swirl Logo T-Shirt

This is 100% cotton T-shirt features a blue and gold swirl around the famous Classic Industries® logo. The swirl logo is on the back of the shirt with the Classic Industries logo on the chest and sleeve. Available in black only.

Note: Please specify size when ordering.

TS1008	M-XL	15.99 ea
TS1008	XXL-XXXL	17.99 ea



M

M. Classic Industries® Official Logo Cap

This great looking cap begins with a super high quality reinforced, brushed twill cap in black. It proudly displays an embroidered full color Classic Industries® logo on the front and Classic Industries® web address on the back, along with our trademark slogan in the sandwich style bill. Fully adjustable cotton strap with silver buckle and matching silver eyelets.

41306	Classic Industries® cap	12.99 ea
-------	-------------------------	----------

A. Classic Industries® Cruiser Mug

Fits in virtually every automobile cup holder. Featuring a closable lid and double wall construction to keep your beverage hot or cold for hours.

J243		6.99 ea
------	--	---------

B. Classic Industries® Mechanics Gloves

Classic Industries mechanics gloves offer outstanding gripping power as well as protection against cuts, burns and abrasions. They offer great dexterity and flexibility for intricate work and feature a soft elastic wrist band with a velcro closure for ease of use. Each glove features a high quality embroidered Classic Industries logo as shown. Small, medium, large, X large and XX large.

12565	specify size	17.99 pr
-------	--------------	----------

C. Classic Industries® Coffee Mug

This classically styled acrylic mug has the look of fine ceramic but is actually made of thick, durable, chip-resistant plastic. Dishwasher and microwave safe!

J247		5.99 ea
------	--	---------

D. Classic Industries® Retractable Pen

Ever wonder where all your pens go? Why not stock up on these eye catching inexpensive retractable pens.

J241		1.99 ea
------	--	---------

E. Classic Industries® Foam Mouse Pad

Molded in 1/4" thick foam adds the finishing touch to any computer work station. Features the Classic Industries® logo and branding.

J244		4.99 ea
------	--	---------

F. Classic Industries® Embossed License Plate

Full color logo license plate for use on any Classic vehicle! Each license plate is manufactured in aluminum and embossed with the Classic Industries logo.

LP12	white	8.99 ea
LP13	black	8.99 ea

G. Classic Industries® Logo Decal

When it comes to quality products, Classic Industries® can't be beat! Our new full color decals can be applied to virtually any clean surface. Comes in a variety of sizes.

CP10A	4" x 1-1/2"	2.99 ea
CP10B	8-1/2" x 4"	4.99 ea
CP10C	17-1/2" x 6"	7.99 ea

H. Classic Industries® Lapel/Hat Pin

Features the well-recognized Classic Industries® logo printed on a quality all metal, epoxy-coated pin and includes a metal retainer.

C106	lapel pin	2.99 ea
------	-----------	---------

I. Classic Industries® Embroidered Patch

This eye-catching patch will look right at home on your favorite hat, shirt or jacket. It features the well-recognized Classic Industries® logo embroidered in full color and ready to go on your favorite apparel.

C107	embroidered patch	2.99 ea
------	-------------------	---------

J. Key Chain Flashlight

Lithium Button Cell batteries provide over 23 hours of continuous light and years of intermittent light. The batteries are replaceable and the LED diode lasts 100,000 hours. Compact and reliable. This key chain flashlight has a convenient swivel key ring for attaching to keys, belt loops, purse straps, and more!

J245		3.99 ea
------	--	---------

K. Classic Industries® Soft Key Tag

These soft key tags are made of a sturdy material that is thick yet pliable, and comes with a spiral key ring. Makes a great give away accessory!

J242		2.99 ea
------	--	---------

N. OER® Key Chain Flashlight

Lithium Button Cell batteries provide over 23 hours of continuous light and years of intermittent light. The batteries are replaceable and the LED diode lasts 100,000 hours. Compact and reliable, OER's LED key chain flashlight has a convenient swivel key ring for attaching to keys, belt loops, purse straps, and more!
J270 1.99 ea

O. OER® Soft Key Tag

These soft key tags are made of a sturdy material that is thick yet pliable, and comes with a spiral key ring.
J25799 ea

P. OER® Retractable Pen

Ever wonder where all your pens go? Why not stock up on these eye catching inexpensive, black and yellow retractable pens.
J25099 ea

Q. OER® Foam Mouse Pad

This highly functional mouse pad, molded in 1/4" thick foam adds the finishing touch to any computer work station. Features the OER® logo.
J251 3.49 ea

R. OER® Insulated Cruiser Mug

This insulated cruiser mug fits in virtually every automobile cup holder. Featuring a closable lid and double wall construction to keep your beverage hot or cold for hours.
J254 7.99 ea

S. OER® 11 oz. Stoneware Mug

This classically styled acrylic mug has the look of fine ceramic but is actually made of thick, durable, chip resistant plastic. Dishwasher and microwave safe! Includes the OER® logo in bright yellow with words "Original Equipment Reproduction".
J252 2.99 ea

T. OER® Foam Insulator

This foam insulator will keep your 12 oz. beverage can cold or your coffee hot for hours! The insulator displays the OER® logo on one side and is microwave and dishwasher safe.
J253 1.99 ea

U. OER® Lapel/Hat Pins

OER® logo on a quality all metal, epoxy coated pin and includes a metal retainer.
OER16 3/4" x 1/2" 1.99 ea
OER18 1-1/4" x 3/8" 1.99 ea

V. OER® Embroidered Patch

OER® logo embroidered in full color. Measures approximately 5" x 1-1/4".
OER21 OER® 1.99 ea

W. OER® Official Logo Cap

High quality reinforced, brushed twill cap in black. It proudly displays an embroidered bright yellow and black OER® logo on the front and side. Features a fully adjustable cotton strap with silver buckle and matching silver eyelets.
41303 black 12.99 ea

X. OER® Badge Holder

OER® logo printed on both sides with an attached chrome plated clip that will accommodate a clip-on or pin-on type name badge.
OER15 black 1.99 ea



Y. OER® Casual Bomber Jacket

Black 100% cotton, fineline sanded twill fabric, unlined, elastic waist jacket features an embroidered trademark yellow OER® logo, heavy duty antique brass zipper and hand warmer pockets.
J255 L-XL 49.99 ea
J255 XXL 59.99 ea

Z. OER® Quality T-Shirt

Black 100% cotton T-shirt with yellow silk screened trademark OER® logo. Available in medium, large, x-large and xx-large.
J259 M-XL 14.99 ea
J259 XXL 16.99 ea

T-Shirt Gallery

Flames, pinstripes, tribal patterns, and more! These 100% cotton T-shirts set the standard with small graphics up front and full illustrations on the reverse side. Browse through our collection of the most popular silk-screen designs to find the style that fits your personal brand. Available on white, black, or gray men's T-shirt.

When ordering, please state men's size S, M, L, XL, XXL or XXXL, unless otherwise specified.

White T-Shirts:

\$15.99 (S-XL) \$17.99 (XXL-XXXXL)

Black or Gray T-Shirts:

\$17.99 (S-XL) \$19.99 (XXL-XXXXL)



ML1001..... White T-shirt
ML1101..... Gray T-shirt
ML1201..... Black T-shirt



ML1005..... White T-shirt
ML1105..... Gray T-shirt
ML1205..... Black T-shirt

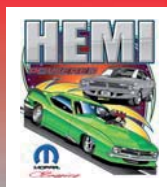

ML1002..... White T-shirt
ML1102..... Gray T-shirt
ML1202..... Black T-shirt

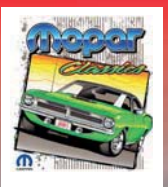

ML1006..... White T-shirt
ML1106..... Gray T-shirt
ML1206..... Black T-shirt



ML1003..... White T-shirt
ML1103..... Gray T-shirt
ML1203..... Black T-shirt



ML1007..... White T-shirt
ML1107..... Gray T-shirt
ML1207..... Black T-shirt



ML1004..... White T-shirt
ML1104..... Gray T-shirt
ML1204..... Black T-shirt



ML1008..... White T-shirt
ML1108..... Gray T-shirt
ML1208..... Black T-shirt



Available in Black, White or Gray



ML1009 White T-shirt
ML1109 Gray T-shirt
ML1209 Black T-shirt



ML1013 White T-shirt
ML1113 Gray T-shirt
ML1213 Black T-shirt



ML1010 White T-shirt
ML1110 Gray T-shirt
ML1210 Black T-shirt



ML1014 White T-shirt
ML1114 Gray T-shirt
ML1214 Black T-shirt



ML1011 White T-shirt
ML1111 Gray T-shirt
ML1211 Black T-shirt



ML1015 White T-shirt
ML1115 Gray T-shirt
ML1215 Black T-shirt



ML1017 White T-shirt
ML1117 Gray T-shirt
ML1217 Black T-shirt

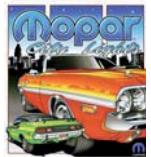

ML1012 White T-shirt
ML1112 Gray T-shirt
ML1212 Black T-shirt

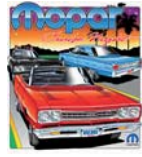

ML1016 White T-shirt
ML1116 Gray T-shirt
ML1216 Black T-shirt

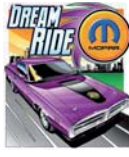

ML1018 White T-shirt
ML1118 Gray T-shirt
ML1218 Black T-shirt



ML1019 White T-shirt
ML1119 Gray T-shirt
ML1219 Black T-shirt

KIDS T-SHIRTS



When I Grow Up T-Shirt or Onesie

We have just the item for the little Mopar fans of the house. This full color shirt features your choice of "When I Grow Up..." logos. It's available as a t-shirt or a onesie for toddlers. Get your little Mopar enthusiast started early!

Mopar Logo	
HR7001 12 month	onesie 16.99 ea
HR7002 24 month	onesie 16.99 ea
HR7011 18 month	t-shirt 14.99 ea
HR7012 2T	t-shirt 14.99 ea
HR7014 4T	t-shirt 14.99 ea
HR7016 6-8	t-shirt 14.99 ea
HR7017 10-12	t-shirt 14.99 ea
Mopar Logo with Hemi Cuda	
HR7021 12 month	onesie 16.99 ea
HR7022 24 month	onesie 16.99 ea
HR7031 18 month	t-shirt 14.99 ea
HR7032 2T	t-shirt 14.99 ea
HR7034 4T	t-shirt 14.99 ea
HR7036 6-8	t-shirt 14.99 ea
HR7037 10-12	t-shirt 14.99 ea



Flaming Charger Kids T-Shirt

We have just the thing for the little Mopar fans of the house. This full color shirt features a Dodge Charger and the logo against flames on the front. Available as a t-shirt for toddlers or kids so you can get your little Mopar enthusiast started early!

TS162XS 2-4 17.99 ea
TS162S 6-8 17.99 ea
TS162M 10-12 17.99 ea
TS162L 14-16 17.99 ea

"My Daddy" or "My Grampa" Drives a Dodge T-Shirt

Get your little Mopar enthusiast started early!

This full color "My Daddy Drives a Dodge..." t-shirt for toddlers or kids is just the thing for the younger fans.

Also available in "My Grampa Drives a Dodge..." for the Mopar-loving grandchild in your family.

Note: Please specify size when ordering.

Daddy Drives a Dodge Logo	
TS160 white 17.99 ea
Grampa Drives a Dodge Logo	
TS161 white 17.99 ea



Fast Girl Mopar "M" Logo

Made from high quality 100% combed, ring-spun cotton. The 1x1 rib has great elasticity and the custom, contoured fit clings to the body. Low shrinkage.

HR5075 S-XL 15.99 ea
HR5075 XXL 17.99 ea



close-up of logo

TC203



close-up of logo

TC204

Rhinestone Ladies Tanks

These sweet black tops for the ladies feature the Dodge or Hemi logos in the center chest with set-in pink rhinestones. It makes a great gift for the girls who want to show off their love for Mopars.

Ladies T-Shirts

Dodge Logo	
TC202 S-XL 19.99 ea
TC202 XXL 21.99 ea
Hemi Logo	
TC203 S-XL 19.99 ea
TC203 XXL 21.99 ea

Ladies Tanks

Dodge Logo	
TC204 S-XL 19.99 ea
TC204 XXL 21.99 ea
Hemi Logo	
TC205 S-XL 19.99 ea
TC205 XXL 21.99 ea



TS209
front

TS209
back



TS210
front

TS210
back

Adult Under Wraps T-Shirts

These white T-shirts are screen printed with classic Mopar graphics wrapped around the side. 100% pre-shrunk cotton.

Dodge Challenger Logo

TS209	M-XL	19.99 ea
TS209	XXL	21.99 ea
TS209	XXXL	22.99 ea

68 Super Bee

TS210	M-XL	19.99 ea
TS210	XXL	21.99 ea
TS210	XXXL	22.99 ea



Warped Heads Challenger

Made from 99% cotton and 1% polyester material. This ash color shirt features Dodge Challenger Warped Heads design printed full size on the rear and a smaller 3" x 5" size design printed on center of chest.

TS206	M	19.99 ea
TS206	XXL	21.99 ea



Dodge Super Bee

Made from 100% preshrunk cotton material. White T-shirt with Super Bee design printed on front.

TS203	M-XL	19.99 ea
TS203	XXL	21.99 ea



Dodge Charger 440

Made from 100% preshrunk cotton material. White T-shirt with Charger 440 design printed on front.

TS204	M-XL	19.99 ea
TS204	XXL	21.99 ea

New!



Mopar Speed Shop Garage T-Shirt

This 100% cotton t-shirt has a Mopar Genuine Parts Speed Shop Garage design. These t-shirts feature the full design on the front. Available in gray.

Note: Please specify size when ordering.

TS186	S-XL	19.99 ea
TS186	XXL	21.99 ea
TS186	XXXL	22.99 ea



Dodge 71 Demon T-Shirts

Made from 100% pre-shrunk cotton material. White t-shirt with 71 Demon design printed on the front.

TS214	M-XL	19.99 ea
TS214	XXL	21.99 ea
TS214	XXXL	22.99 ea



Dodge Challenger

Made from 100% preshrunk cotton material. White T-shirt with Challenger design printed on front.

TS205	M-XL	19.99 ea
TS205	XXL	21.99 ea



One Hundred Percent Mopar

Made from 100% preshrunk cotton material. White T-shirt with 1964 Mopar design printed on back and pocket sized logo printed on chest.

HRP2103	M-XL	17.99 ea
HRP2103	XXL	19.99 ea

New!



MD7201L



MD7205L

MD7202L

Mopar Camp Shirts

Mopar Camp Shirt features classic Mopar muscle cars and the iconic logos on a solid colored background. Matching left chest pocket and coconut buttons. Made from machine washable 55% cotton/45% rayon. Officially licensed by Chrysler Group LLC. Available in sizes medium through XXX-Large.

Mopar Charger Black Camp Shirt

MD7201M	M	39.99 ea
MD7201L	L	39.99 ea
MD7201XL	XL	39.99 ea
MD7201XXL	XXL	40.99 ea
MD7201XXXL	XXXL	41.99 ea

Mopar Barracuda Dark Blue Camp Shirt

MD7205M	M	39.99 ea
MD7205L	L	39.99 ea
MD7205XL	XL	39.99 ea
MD7205XXL	XXL	40.99 ea
MD7205XXXL	XXXL	41.99 ea

Mopar Challenger Gray Camp Shirt

MD7202M	M	39.99 ea
MD7202L	L	39.99 ea
MD7202XL	XL	39.99 ea
MD7202XXL	XXL	40.99 ea
MD7202XXXL	XXXL	41.99 ea

New!



Dodge Challenger Car Collector T-Shirt

This 100% cotton t-shirt has a Dodge Challenger Car Collector design. These t-shirts feature the full design on the front. Available in black.

Note: Please specify size when ordering.

TS184	S-XL	19.99 ea
TS184	XXL	21.99 ea
TS184	XXXL	22.99 ea

New!



MD7203L



back design

MD7204L

Mopar Club Shirts

Officially licensed Mopar Club Shirts. Available in sizes medium through XXX-Large. Officially licensed by Chrysler Group LLC.

Mopar Club Shirt

Mopar Club Shirt features Mopar logo embroidered left chest. Made from machine washable 70% cotton/30% polyester.

MD7203M	M	39.99 ea
MD7203L	L	39.99 ea
MD7203XL	XL	39.99 ea
MD7203XXL	XXL	40.99 ea
MD7203XXXL	XXXL	41.99 ea

Mopar Pit Shirt

This pit shirt features the Mopar logo embroidered on the left chest with a large Mopar embroidery on the back. Made from machine washable 65% polyester/35% cotton.

MD7204M	M	39.99 ea
MD7204L	L	39.99 ea
MD7204XL	XL	39.99 ea
MD7204XXL	XXL	40.99 ea
MD7204XXXL	XXXL	41.99 ea

New!



Dodge Charger T-Shirt

This 100% cotton t-shirt has a Dodge Charger with checkered flag design. These t-shirts feature the full design on the front. Available in black.

Note: Please specify size when ordering.

TS183	S-XL	19.99 ea
TS183	XXL	21.99 ea
TS183	XXXL	22.99 ea

New!



Mopar Luckys Speed Shop T-Shirt

This 100% cotton t-shirt has a Mopar Luckys Speed Shop Mopar Specialties design. These t-shirts feature the full design on the front. Available in tan.

Note: Please specify size when ordering.

TS188	S-XL	19.99 ea
TS188	XXL	21.99 ea
TS188	XXXL	22.99 ea

New!



Mopar Luckys Speed Shop T-Shirt

This 100% cotton t-shirt has a Mopar Luckys Speed Shop Mopar Specialties design. These t-shirts feature the full design on the front. Available in blue.

Note: Please specify size when ordering.

TS187	S-XL	19.99 ea
TS187	XXL	21.99 ea
TS187	XXXL	22.99 ea

New!



Mopar Muscle T-Shirt

This 100% cotton t-shirt has a Mopar Muscle design. These t-shirts feature the full design on the front. Available in tan.

Note: Please specify size when ordering.

TS185	S-XL	19.99 ea
TS185	XXL	21.99 ea
TS185	XXXL	22.99 ea

New!



Laid-Back Canvas Mopar

This 100% ring spun cotton T-Shirt features rugged Mopar muscle on premium garment washed colors. Large print on back with small pocket logo.

Note: Please specify size when ordering.

MP2101	S-XL	21.99 ea
MP2101	XXL	24.99 ea
MP2101	XXXL	24.99 ea

New!



Laid-Back US Flag Mopar

This 100% ring spun cotton T-Shirt features Mopar tradition on premium garment washed colors. Large print on back with small pocket logo.

Note: Please specify size when ordering.

MP2104	S-XL	21.99 ea
MP2104	XXL	24.99 ea
MP2104	XXXL	24.99 ea

New!



Laid-Back Cooler Mopar

This 100% ring spun cotton T-Shirt tells it like it is with premium garment washed colors. Large print on back with small pocket logo.

Note: Please specify size when ordering.

MP2107	S-XL	21.99 ea
MP2107	XXL	24.99 ea
MP2107	XXXL	24.99 ea

New!



Laid-Back Ink Good Fight Mopar

Rev up and roll out with this 100% ring spun cotton T-Shirt featuring premium garment washed colors. Large print on back with small pocket logo.

Note: Please specify size when ordering.

MP2102	S-XL	21.99 ea
MP2102	XXL	24.99 ea
MP2102	XXXL	24.99 ea

New!



Laid-Back Halfway 70 Challenger

This 100% ring spun cotton T-Shirt features plum crazy power on premium garment washed colors. Large print on back with small pocket logo.

Note: Please specify size when ordering.

MP2105	S-XL	21.99 ea
MP2105	XXL	24.99 ea
MP2105	XXXL	24.99 ea

New!



Laid-Back Kingston 70 Cuda

This 100% ring spun cotton T-Shirt features high octane fuel for the soul on premium garment washed colors. Large print on back with small pocket logo.

Note: Please specify size when ordering.

MP2108	S-XL	21.99 ea
MP2108	XXL	24.99 ea
MP2108	XXXL	24.99 ea

New!



Laid-Back Dodge Power

This 100% ring spun cotton T-Shirt features deep blue Dodge power on premium garment washed colors. Large print front.

Note: Please specify size when ordering.

MP2103	S-XL	21.99 ea
MP2103	XXL	24.99 ea
MP2103	XXXL	24.99 ea

New!



Laid-Back Cuda Grunge

This 100% ring spun cotton T-Shirt features rugged Hemi power on premium garment washed colors. Large print on back with small pocket logo.

Note: Please specify size when ordering.

MP2106	S-XL	21.99 ea
MP2106	XXL	24.99 ea
MP2106	XXXL	24.99 ea

New!



Laid-Back Dream Garage Mopar

This 100% ring spun cotton T-Shirt proves that not all garages are created equal. Features premium garment washed colors. Large print on back with small pocket logo.

Note: Please specify size when ordering.

MP2110	S-XL	19.99 ea
MP2110	XXL	21.99 ea
MP2110	XXXL	22.99 ea



blue & gray



back detail

A Dodge Charger Caps

These unique low profile brushed cotton twill caps feature a raised Dodge Charger logo embroidered on the crown and above the rear strap along with a Ram logo embroidered on the fancy bill. Fully adjustable to all sizes with velcro closure. Specify black, blue or gray when ordering.

H194 Dodge Charger logo 16.99 ea

B. Dodge Hemi Caps

Tell them what's under the hood with a Dodge Hemi cap! These unique low profile brushed cotton twill caps feature a raised Dodge Hemi logo embroidered on the crown and a Dodge script on the rear strap along with a woven Hemi logo sewn onto front and rear of cap. Fully adjustable to all sizes with velcro closure. Specify black, blue, bone or gray when ordering.

H175 Dodge Hemi logo 16.99 ea

C. Dodge Ram Caps

A Dodge cap for every member of the family! These unique low profile brushed cotton twill caps feature a raised Dodge Ram logo embroidered on the crown and a Hemi script on the rear strap along with a woven Dodge logo sewn onto front edge of the bill. Fully adjustable to all sizes with velcro closure. Specify black, blue or bone when ordering.

H187 Dodge Ram logo 16.99 ea

D. Dodge Ram Logo Cap

These low profile brushed cotton twill caps feature a raised flamed bill and the Dodge Ram logo embroidered on the crown. Fully adjustable velcro closure. Choose from a variety of colored flames.

H174G with gray & blue flames 17.99 ea

H174Y with yellow & red flames 17.99 ea

H174R with red & orange flames 17.99 ea



back detail

E. Liquid Metal Logo Cap

This stylish, black low profile cap is made from brushed heavyweight cotton and features raised "liquid metal" lettering for a chrome emblem-like appearance. There's also a chrome welding embedded in the edge of the bill and a liquid metal Dodge logo on the velcro closure strap. One size fits all.

HT121 Hemi 17.99 ea

F. Mopar Caps

Let everyone know that you are a Mopar fan with one of these unique low profile brushed cotton twill caps featuring the Mopar "M" logo embroidered on the crown. Fully adjustable to all sizes with velcro closure. Specify black/black, khaki/blue or khaki/black when ordering.

H176 "M" Mopar logo 14.99 ea

G. R/T Dodge Caps

Send the message that you mean business with these Road/Track caps! These unique low profile brushed cotton twill caps are fully adjustable to all sizes with velcro closure. Specify black/black, khaki/blue or khaki/black when ordering.

H162 R/T Dodge logo 14.99 ea



**OFFICIAL
LICENSED
PRODUCT**

H. Dodge Cap

New!

This low profile cotton cap features the Dodge name with racing stripes embroidered on the cap. Available in black with red trim or bone with black trim. Velcro closer on the back.

H299B black w/red trim..... 16.99 ea
H299N bone w/black trim..... 16.99 ea

I. Mopar Performance Caps

Low profile with brushed cotton twill and fully adjustable velcro closure. Specify black/black, khaki/blue or khaki/black when ordering.

H119 Mopar Performance logo..... 14.99 ea

J. Hemi Caps

Low profile with brushed cotton twill and fully adjustable velcro closure. Specify black/black, khaki/blue or khaki/black when ordering.

H169 Hemi logo..... 14.99 ea

K. Dodge Ram Ladies Cap

Unique low profile soft crown washed twill cap features a raised Dodge Ram logo embroidered on the crown. Fully adjustable to all sizes with a hideaway buckle closure. Pink cap with pink embroidery.

H190P Dodge Ram pink..... 16.99 ea

L. Womens Hemi Cap

This 100% cotton cap is made just for the ladies with a rhinestone floral design and a sparkle fleck Hemi logo. Adjustable closure, one size fits all.

TC702 Hemi cap black..... 25.99 ea

M. Dodge Cap

This low profile brushed cotton twill cap features a raised Dodge logo embroidered on the crown. Fully velcro closure. Specify black or khaki when ordering.

H115 Dodge logo..... 14.99 ea

N. Mopar "M" Logo Cap

These low profile brushed cotton twill cap, features a raised flamed bill and the Mopar "M" logo embroidered on crown. Fully adjustable velcro closure.

H176G with gray & blue flames..... 17.99 ea

O. Dodge Challenger Low Profile Caps

These low profile caps feature a raised Challenger logo and "Dodge" lettering on the front of the crown, Dodge lettering on the sandwich bill and "Dodge" lettering on the closure. One size fits all with a Velcro closure on the back. Specify black, blue or bone when ordering.

H204 specify color..... 16.99 ea



H

I



J



K

L



M

N



back detail

bill detail



O



Mopar Heritage Series Ceramic Mug Collection



The Mopar ceramic mug collection featuring vintage logos from the 60s and 70s muscle car era. Each ceramic mug features rare and original Mopar muscle car symbols. These beautiful 11 ounce white porcelain mugs are baked with colorful enamels that are permanent and dishwasher safe. Collect all 12 Mopar ceramic mugs. They're great for home and the office, and they make a great gift for Mopar fans of all ages.



MN1886	AAR Cuda	14.99	ea
MN1887	Demon 340	14.99	ea
MN1888	Dodge Scat Pack	14.99	ea
MN1889	426 Hemi	14.99	ea
MN1890	Duster 340	14.99	ea
MN1891	R/T	14.99	ea
MN1892	Dodge Triad Symbol	14.99	ea
MN1893	Plymouth Rapid Transit System	14.99	ea
MN1894	Super Bee	14.99	ea
MN1895	Plymouth GTX	14.99	ea
MN1896	Dodge Boys	14.99	ea
MN1897	Shaker	14.99	ea



Neon Clocks

Display your Mopar pride and enthusiasm for classic cars by bringing this nostalgic look to your home or garage with these neon clocks.			
NS100034	Mopar arrow	69.99	ea
NS100035	Mopar Hemi	69.99	ea
NS100036	Vintage Mopar parts & accs.	69.99	ea



Die Cast Engine Collectibles

These 1/6 scale engines are the perfect gift for any collector. All hand assembled with precision and accuracy any collector would be amazed with the detail and work that was put into these engines.

84023	Hemi 426	36.99	ea
84024	Hemi racing engine	36.99	ea
84028	Hemi Top Fuel	36.99	ea



3-D Wall Shelves & Coat Racks

These combination 3-D wall shelves and coat racks will give you a place for tools, keys, drinks, or anything else you can think of. These combination 3-D wall shelves and coat racks will make a great addition to your house, garage, or office. They are made from resin. The screw driver and cresent wrench are 3-D wall shelves and coat racks and are approximately 5 1/4" tall and approximately 18-1/2" wide. The screw driver 3-D wall shelf and coat rack has an orange and black handle with a silver blade and the cresent wrench 3D wall shelf and coat rack is silver, they both feature a tempered glass shelf.

SB758009	screw driver	59.99	ea
SB758010	cresent wrench	59.99	ea



426 Hemi Engine Table Lamp

This 1/6:1 scale engine table lamp is constructed with a sturdy plastic base and posts. The air cleaner is removable to reveal a highly detailed carburetor. The starter motor gear drives the flywheel gear which turns the fan, the fan pulleys, belts, alternator and power steering pump. The shade features a collage of photos of the featured engine. The 84" cord with push button on/off switch allows you to place this lamp anywhere you like. 120V/60W bulb is included. Officially licensed by Dodge. 62001



Dodge buckle detail



Dodge Buckle Bags

With unique seatbelt buckles and webbed nylon accents, these durable, great looking bags are driving fashion in a new direction. Available with black/silver stripe webbing, 8" x 6" x 3".



Chrysler and Dodge Belt Buckles

Show your Mopar pride with one of these premium belt buckles. The tough-looking brushed buckles feature an embossed Mopar logo of your choice. Each buckle measures approx. 2.5" x 4". Be sure to purchase a quality leather strap to complement these stylish metal buckles. Straps are sold separately and available in sizes S-XL.

Note: Specify Strap Size When Ordering.

Dodge Ram Buckles

BD403	Ram/Dodge brushed silver	21.99 ea
BD502	Ram/Dodge framed black/silver	21.99 ea
BD503	Ram/Dodge framed black/red	21.99 ea
BD611	Ram logo framed oval	21.99 ea
BD702	Ram logo framed walnut	21.99 ea
BD900	Mopar red/white/blue	21.99 ea
BD901	Charger black/silver	21.99 ea
BD902	Charger black/silver	21.99 ea
BD903	Charger walnut	21.99 ea
BD904	Charger walnut	21.99 ea
BD905	Dodge black/silver	21.99 ea
BD906	Dodge walnut	21.99 ea

Leather Belts

BD600	Black Leather Strap	9.99 ea
BD601	Brown Leather Strap	9.99 ea



Chrysler, Dodge & Mopar Belts w/Seat Belt Buckle

Manufactured with authentic seat belt buckles. These belts are constructed from tough nylon webbing that is fully adjustable from 24" to 40". For all the Mopar fans out there looking for a little more automotive style.

Note: Specify Color When Ordering.

BD101	Chrysler logo	24.99 ea
BD201	Dodge logo	24.99 ea
BD914	Mopar logo	24.99 ea



Chrysler & Dodge Belts w/Flip Style Buckle

Manufactured with flip style buckles. These belts are constructed from tough nylon webbing that is fully adjustable from 24" to 40". For all the Mopar fans out there looking for a little more automotive style.

Note: Specify Color When Ordering.

BD301	Chrysler logo	silver/black	19.99 ea
BD302	Chrysler logo	silver/black	19.99 ea
BD303	Dodge logo	black/red	19.99 ea
BD304	Dodge logo	black/silver	19.99 ea
BD305	Dodge logo	silver/black	19.99 ea

New!



Mopar Belts w/Flip Style Buckle

For all the Mopar fans out there looking for a little more automotive style. Manufactured with authentic seat belt buckles, these belts are constructed from tough nylon webbing that is fully adjustable from 24" to 40". Available in the colors and styles shown.

Black Belt

BD915	w/Mopar "M" logo brushed buckle	14.99 ea
BD916	w/red/white/blue Mopar buckle	14.99 ea

Black Buckle

BD917	w/blue racing stripes and Mopar logo	14.99 ea
BD918	w/blue racing stripes and Mopar "M" logo	14.99 ea

New!

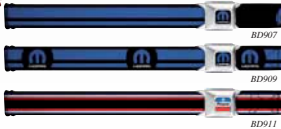

Mopar Racing Stripe Belts w/Seat Belt Buckle

For all the Mopar fans out there looking for a little more automotive style. Manufactured with authentic seat belt buckles, these belts are constructed from tough nylon webbing that is fully adjustable from 24" to 40". Available in the colors and styles shown.

BD907	blue racing stripes	29.99 ea
BD909	blue racing stripes with Mopar logo	29.99 ea
BD911	red/white/blue racing stripes	29.99 ea

MUSCLECAR BLVD

Porcelain Street Signs

As tough and authentic as a real street sign with heavy embossed letters and bright, baked-on enamel color. This heavy, stamped, steel street sign will steer you in the right direction every time! Perfect for decorating the workshop, den or rec room!
GC2080 musclecar boulevard..... 34.99 ea



ML13202



ML13203



ML13205



ML13206



ML13208



ML13209



ML13214



ML13215



ML13217



ML13218

Mopar Collectable Tin Signs

Create a rugged sense of decor and bring timeless Mopar style into your home, garage, or office with these vintage collectable signs. Nothing shows off your Mopar pride quite like the classic Chrysler logos and weathered look of these beautiful signs. Made from heavy gauge, corrosion resistant tin.

ML13202	15" x 12"	1970 Plymouth GTX Hemi	19.99 ea
ML13203	12-1/2" x 17-1/2"	Dodge Challenger R/T	19.99 ea
ML13205	12-1/2" x 17-1/2"	Dodge Dart GT5...	19.99 ea
ML13206	12-1/2" x 17-1/2"	Dodge Super Bee	19.99 ea
ML13208	18" x 12"	Super Bee	19.99 ea
ML13209	12" round	Super Bee	19.99 ea
ML13214	16" x 12-1/2"	Mopar Logo - 1937-47	19.99 ea
ML13215	16" x 12-1/2"	Mopar Logo - 1964-71	19.99 ea
ML13217	12" round	Mopar Parts and Accessories	19.99 ea
ML13218	12-1/2" x 16"	Mopar-Hemi Powered	19.99 ea
ML13220	12-1/5" x 16"	Mopar - You're With Us Or You're Behind Us	19.99 ea



FB4102



FB4108



FB5102



FB4501



FB5301



FB5004



FB5001



FB4702



FB4107



FB4100



FB4301



FB4303

Thom SanSoucie's Flash Back Prints

Thom SanSoucie's "Flash Back Prints" collection is a great way to decorate your home, office or garage. These elegant black and white prints are truly unique automotive collectibles that commemorate Mopar's golden years. Choose from a large variety of years and models featuring many different backgrounds! Each illustration is 11"x17" and comes mounted on a sturdy showboard ready to mat or frame.

Note: Frame not included.

A-Body			
FB4102	1966-69	Barracuda.....	15.99 ea
FB4108	1966-69	Barracuda.....	15.99 ea
FB5101	1966-69	Dart.....	15.99 ea
FB5102	1967-70	Dart.....	15.99 ea
FB5100	1966-71	Dart.....	15.99 ea
FB4500	1970-73	Demon/Duster.....	15.99 ea
FB4501	1970-73	Demon/Duster.....	15.99 ea
B-Body			
FB5300	1964-65	Fury.....	15.99 ea
FB5304	1964-67	Belvedere, GTX.....	15.99 ea
FB5303	1967	Belvedere, GTX.....	15.99 ea
FB5300	1967-70	Belvedere, GTX.....	15.99 ea
FB5301	1967-70	Belvedere, GTX.....	15.99 ea
FB5302	1967-70	Belvedere, GTX.....	15.99 ea
FB5004	1966	Charger.....	15.99 ea
FB5002	1966-74	Charger.....	15.99 ea
FB5001	1968-69	Charger.....	15.99 ea
FB5003	1968-69	Charger.....	15.99 ea
FB5005	1969-73	Charger.....	15.99 ea
FB5200	1965-67	Coronet.....	15.99 ea
FB5201	1968-70	Coronet.....	15.99 ea
FB5202	1968-70	Coronet, Super Bee.....	15.99 ea
FB5203	1965-70	Coronet convertibles.....	15.99 ea
FB4000	1967-71	GTX, Road Runner, Super Bee.....	15.99 ea
FB4201	1968-69	Road Runner.....	15.99 ea
FB4202	1968-72	Road Runner, Superbird.....	15.99 ea
FB4700	1969-70	Superbird, Daytona, at Mobil Station.....	15.99 ea
FB4701	1969-70	Superbird, Daytona, at Ice Cream Shop.....	15.99 ea
FB4702	1969-70	Superbird, Daytona, at Gulf Station.....	15.99 ea
FB4200	1970	Road Runner.....	15.99 ea
FB4204	1970-72	Coronet, Road Runner, Charger, Super Bee.....	15.99 ea
E-Body			
FB4203	1970	various models.....	15.99 ea
FB4107	1970	'Cuda.....	15.99 ea
FB4103	1970	'Cuda.....	15.99 ea
FB4101	1970-73	'Cuda.....	15.99 ea
FB4102	1970-73	'Cuda.....	15.99 ea
FB4104	1971	'Cuda.....	15.99 ea
FB4106	1972-74	'Cuda & Barracuda.....	15.99 ea
FB4300	1970	Challenger hardtops at Gas Station.....	15.99 ea
FB4301	1970	Challenger hardtop & Conv. at Mobil Station.....	15.99 ea
FB4302	1970	ChallengerA.....	15.99 ea
FB4303	1970	Challenger.....	15.99 ea
FB4305	1971	Challenger.....	15.99 ea
FB4306	1971	Challenger.....	15.99 ea
FB4303	1972-74	Challenger.....	15.99 ea

Car Art by David Snyder

This collection of limited edition prints is numbered and hand signed by the artist, David Snyder. Each represents 200 to 300 hours of painting, historical research and fine tuning. The original painting is meticulously hand painted without any computer generated or airbrushed art. Own one of these limited edition prints!

"Back to Brice" Limited Edition Print

At the August Mopar Nationals, the party always moves to Brice Road. Mopars light up the night as the sun goes down on Reynoldsburg, Ohio. Fans cheer as drivers put on this unofficial parade. "Back to Brice" is limited to 750 signed and numbered prints. Printed on high-quality acid-free stock trimmed to 20" x 36", image measures 15.5" x 34".
DSP101 "Back to Brice"..... 110.99 ea



"Sweetest" Limited Edition Print

In 1972, there were many ways to satisfy your sweet tooth, but the best way to satisfy the need for ground pounding horsepower from a Hemi Challenger, Cuda, Roadrunner or Charger Daytona. There was just one word for the experience: "Sweetest!". Just 950 signed and numbered prints will be produced. Printed on high quality acid-free stock and trimmed to 22" x 28", image measures 18.5" x 26".
DSP102 "Sweetest"..... 90.99 ea



"Mopar Strip" Limited Edition Print

"Mopar Strip" gives us a nostalgic look back at the glitz and glamour of the iconic landmarks along Las Vegas Boulevard in 1972 with some of the best Mopar Muscle in the foreground. Just 950 signed and numbered prints will be produced. Each print is signed and numbered by the artist. Printed on premium, acid-free stock trimmed to 23" x 36", image measures 19.5" x 34".
DSP103 "Mopar Strip"..... 110.99 ea



"Fish Food" Limited Edition Print

Plymouth beat Ford in the Pony Car War by just two weeks with the Barracuda—it was the first and it became the best. Other pony cars were just "fish food" as the Hemi Cuda became king of the street. Just 950 signed and numbered "Fish Food" prints will be produced. Printed on high quality, acid-free stock trimmed to 22" x 28", image measures 18" x 24".
DSP104 "Fish Food"..... 85.99 ea



"Fun in the Sun" Limited Edition Print

Celebrate the pinnacle of convertibles and those lazy, fun-filled summer days of sun and surf at the beach with "Fun in the Sun", featuring some of the best Mopar drop tops from Chrysler, Dodge, Plymouth and DeSoto. Limited edition of just 950 signed and numbered prints. Image size 18" x 26.5" on 22" x 28" heavy paper.
DSP105 "Fun in the Sun"..... 85.99 ea



"Quick and Dependable" Limited Edition Print

This print, entitled "Quick and Dependable," puts the spotlight on a Dodge dealership packed with performance. This painting captures the spirit of Mopar performance with this painting. Each print is signed and numbered by the artist, David Snyder, and is also signed by "Mr. Norm" Kraus of the famous Grand Spaulding Dodge dealership. Print measures 18" x 26" and is printed on high quality, acid-free stock trimmed to 22" x 28".
DSP106 "Quick and Dependable" limited edition..... 99.99 ea



MN1913

MN1914

MN1915

MN1916

Mopar Cartoon Collection by Gary Wren

Get yourself some of the zany and outrageous animated artwork of automotive artist Gary Wren for your home, office, garage or for a friend. Gary's cartoons capture the zeal and unexplainable infatuation we all possess. Collect the entire set of Limited Edition Prints! 14" x 18".

MN1913	1962	Dodge Dart Max Wedge.....	17.99 ea
MN1914	1964	Dodge 330 (old school Hemi-ology).....	17.99 ea
MN1915	1963	Dodge 330, 1963 Savoy.....	17.99 ea
MN1916	1963	Plymouth Savoy.....	17.99 ea



MN1917

MN1918

MN1919

MN1920



MN1921

MN1924

MN1927

MN1928



MN1922

MN1923

MN1925

MN1926



Mopar Limited Edition Advertising Collection

The Mopar limited edition advertising collection featuring vintage logos from the 60s and 70s muscle car era. These classic Mopar Advertisements are reproduced on acid free museum quality Hanoort Silk paper stock with permanent inks and are available in 13.5" x 17.5" size format. These limited edition prints come shrinkwrapped for protection until framing is desired. Collect the entire set of 12 Mopar Muscle Car Limited Edition Advertising Prints!

MN1917	1970 Hemi Cuda (Cuda Power).....	17.99 ea
MN1918	1970 Hemi Motor Cartoon (Beat It).....	17.99 ea
MN1919	1967 Coronet.....	17.99 ea
MN1920	1967 Belvedere.....	17.99 ea
MN1921	Dodge Scat Pack cartoon by Gary Wren.....	17.99 ea
MN1922	1971 Duster.....	17.99 ea
MN1923	1969 Road Runner.....	17.99 ea
MN1924	1970 Plymouth Rapid Transit System.....	17.99 ea
MN1925	1970 Challenger.....	17.99 ea
MN1926	1969 Super Bee (Six Pack To Go).....	17.99 ea
MN1927	1969 Charger R/T (Wailer).....	17.99 ea
MN1928	1969 Swinger 340 (Swinger).....	17.99 ea

Belly Up to These Officially Licensed Mopar Counter Stools and Pub Tables!



Choose from 14 Licensed Tabletop and Stool Seat Styles!



1948-53 Mopar Logo

01



1959-63 Mopar Logo

02



1948-53 Black/Red

03



1948-53 Blue/Yellow

04



1954-58 Mopar Logo

05



1948-53 Orange/Yellow

06



1972-84 Mopar Logo

07



2001-13 Mopar Logo

08



440 Super Commando

09



340 Four Barrel

10



440 Magnum

11



440 6BBL

12



426 HEMI

13



Air Grabber

14



OFFICIAL
LICENSED
PRODUCT



MD670101



MD670102



MD670103



MD670104



MD670105



MD670106



MD670107



MD670108



MD670109



MD670110



MD670111



MD670112



MD670113



MD670114



Mopar Counter Stools

Display your Mopar pride in your home, garage, or office with 30" tall counter stools. Mopar stools feature rugged vinyl covers on 14" diameter seats, swivel bases and chrome plated legs. Made in USA.

Note: Please add 2 digit style code to part number when ordering.
MD6701 w/chrome base 99.99 ea



black without foot rest



chrome with foot rest



black without foot rest



chrome without foot rest



chrome with foot rest

Mopar Pub Tables



Display your Mopar pride in your home, garage, or office 42" tall pub tables. Pub tables feature 30" surface and your choice of black or chromed steel cross bases without foot rest or chrome with foot rest. Made in USA.

Note: Please add 2 digit style code to part number when ordering.

Without Foot Rest

MD6711 with black base 349.99 ea

MD6721 with chrome base 399.99 ea

With Foot Rest

MD6731 with chrome base 369.99 ea



MD674113B



How to Order Tables and Stool Sets:

Please add the 2-digit style code & base code to the end of the part number. For example:

MD6741 13 B = Mopar 426 HEMI Table & Stool Set with Chrome Base

Part# Style# Base Code

Mopar Pub Table and Stool Sets

Purchase a matching pub table and stool set and save! These exclusive sets include one officially licensed Mopar pub table and a pair of Mopar stools. The table surface measures 30" across and 42" tall and includes your choice base: black wrinkle finish, chrome, or chrome with footrest. Stools features a padded vinyl 14" swivel-seat and chrome plated legs.

Base Type: A = Black Base, B = Chrome Base and C = Chrome Base w/Footrest.

MD6741 black base 494.99 set

MD6741 chrome base 539.99 set

MD6741 chrome base w/footrest 512.99 set



Mopar Playing Cards

The Mopar playing card collection featuring vintage logos from the 60s and 70s muscle car era. These attractive collectible playing cards are printed on the finest playing card stock with a lifetime plastic coating. Collect the entire set of 10 Mopar muscle car playing cards.

MN1872	Cuda.....	8.99 ea
MN1873	Dodge Demon.....	8.99 ea
MN1874	Dodge Boys.....	8.99 ea
MN1875	Mighty Mopar.....	8.99 ea
MN1877	Plymouth Rapid Transit System.....	8.99 ea
MN1878	Chrysler Pentastar.....	8.99 ea
MN1879	R/T.....	8.99 ea
MN1882	Dodge Triad.....	8.99 ea
MN1884	Swinger.....	8.99 ea
MN1885	Old Chrysler Logo.....	8.99 ea



Commemorative Metal Signs

A Classic Industries® exclusive! These PhotoSteel signs display your favorite Mopar emblems and logos on corrosion-resistant steel. These signs can be used even in harsh outdoor environments and are sturdy enough to be mounted on a wall without framing, to stand independently, to use as a table top, or to hang freely from the ceiling. Heavy gauge steel construction provides a rich, substantial feel that will continue to impress for years to come.

PS500101	Coronet R/T	14" x 6"	29.99 ea
PS500102	Super Bee	14" x 7"	29.99 ea
PS500103	Barracuda Fish	14" x 8"	29.99 ea
PS500104	"383"	22" x 3"	29.99 ea
PS500105	"440"	20" x 2"	29.99 ea
PS500106	"340 Magnum"	21" x 2"	29.99 ea
PS500107	"Cuda 340"	20" x 3"	29.99 ea
PS500108	"Cuda 383"	20" x 3"	29.99 ea
PS500109	"Cuda 440-6"	20" x 2"	29.99 ea
PS500110	"383 Magnum"	21" x 2"	29.99 ea
PS500111	"440 Magnum"	20" x 2"	29.99 ea
PS500112	Barracuda V8	18" x 4"	29.99 ea
PS500113	Dart	20" x 2"	29.99 ea
PS500114	Demon	18" x 7"	29.99 ea
PS500115	Duster	20" x 4"	29.99 ea
PS500116	GTX	14" x 4"	29.99 ea
PS500117	Charger	22" x 4"	29.99 ea
PS500118	Barracuda	20" x 3"	29.99 ea
PS500119	Challenger	20" x 4"	29.99 ea
PS500120	Cuda	20" x 4"	29.99 ea
PS500121	Pentastar	12" x 11"	29.99 ea
PS500122	Plymouth	23" x 2"	29.99 ea
PS500123	Coronet 440 Medallion	12" x 12"	29.99 ea
PS500124	Coronet 500 Medallion	12" x 12"	29.99 ea
PS500125	Charger Medallion	12" x 12"	29.99 ea
PS500126	Hemi	20" x 3"	29.99 ea
PS500127	Charger Spear	20" x 4"	29.99 ea
PS500128	Road Runner	20" x 4"	29.99 ea



AUTOMOTIVE LIFESTYLE PRODUCTS



NS100106



NS100105



NS100107



Neon Signs

Display your Mopar pride and enthusiasm for classic cars by bringing this nostalgic look to your home or garage with these neon signs.

NS100105	Hemi powered	36" x 12"	359.99 ea
NS100106	Mopar omega	23" x 23"	359.99 ea
NS100107	Vintage shield	32" x 17"	359.99 ea



E1032300 E1032301 E1032302 E1032303 E1032306 E1032307 E1032310 E1032312 E1032314



E1032316 E1032318 E1032320 E1032322 E1032325 E1032327 E1032328 E1032329 E1032330



E1032332 E1032340 E1032341 E1032342 E1032346 E1032347 E1032348 E1032419



Teardrop Key Chain



Elegant jewelry quality engraved key chains include a luxurious look and feel. Yag laser engraving maintains a high quality, long lasting logo.

E1032300	Barracuda.....	8.99 ea	E1032325	R/T.....	8.99 ea
E1032301	Cuda.....	8.99 ea	E1032327	426 Hemi.....	8.99 ea
E1032302	Challenger.....	8.99 ea	E1032328	Super Bee.....	8.99 ea
E1032303	Challenger R/T.....	8.99 ea	E1032329	426 Hemi (slanted).....	8.99 ea
E1032306	Charger.....	8.99 ea	E1032330	Hemi.....	8.99 ea
E1032307	Charger R/T.....	8.99 ea	E1032332	Hemi (reverse).....	8.99 ea
E1032310	Dart.....	8.99 ea	E1032340	340 Magnum.....	8.99 ea
E1032312	Daytona.....	8.99 ea	E1032341	383 Magnum.....	8.99 ea
E1032314	Demon.....	8.99 ea	E1032342	440 Magnum.....	8.99 ea
E1032316	Duster.....	8.99 ea	E1032346	Cuda 340.....	8.99 ea
E1032318	GTX.....	8.99 ea	E1032347	Cuda 383.....	8.99 ea
E1032320	Plymouth (block).....	8.99 ea	E1032348	Cuda 440-6.....	8.99 ea
E1032322	Plymouth.....	8.99 ea	E1032419	Dodge.....	8.99 ea



Dodge Seat Belt Key Chain

This key chain conveniently releases your keys with a push of the button! Two snaps on the 1 inch nylon webbing make it easy to attach to your belt, purse, sports bag, etc. It is made with a miniature seat belt buckle clasp that really works!
B513 Ram/Dodge logo..... 13.99 ea



Dodge Seat Belt Key Holder

This key holder is made out of an authentic seat belt buckle. With the push of a button, your keys slip into your hand. A clip on the back allows you to easily attach the key holder to your belt. This durable key holder makes a great gift.
B511 Ram/Dodge logo..... 14.99 ea

New!



Mopar Emblem Keychain

This classic blue Mopar Keychain is a true work of art. The baked enamel in official Mopar blue and bright nickel plating will warm the heart of any Mopar fan. To the Mopar lover, this keychain says it all. Measures approximately 3". Officially Licensed Mopar Product.
MD1654 6.99 ea

New!



Mopar Piston Keychain

This Mopar Piston keychain features all metal construction, bright chrome plating, and articulating piston head on a realistic connecting rod. Heavy duty epoxy dome covered Mopar logo. Measures 2-1/8". Officially Licensed Mopar Product.
MD1656 7.99 ea

New!



Mopar Connecting Rod Keychain

This combination keychain and bottle opener features heavy, all-metal construction and bright chrome plating. This realistic miniature connecting rod features heavy duty epoxy dome covered Mopar logo. Measures 2". Officially Licensed Mopar Product.
MD1658 7.99 ea

New!



Mopar Lanyard

The classic Mopar logo dominates this cool and practical key and badge lanyard. Crafted of 100% nylon, this sturdy lanyard features a detachable key and badge fob. Includes a cool, inlaid enamel keychain with the classic Mopar logo. Officially Licensed Mopar Product.
MD1657 7.99 ea

New!



Mopar Insulated Piston Can Holder

Gleaming stainless steel piston-shaped drink can cooler. Baked-in enamel art. Cleverly designed to make drinking more convenient with reduced weight, yet still keep the can cold. Officially Licensed Mopar Product.
MD1659 19.99 ea



LF12265B

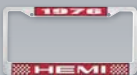

LF12276C

Year/Hemi Frames



Show off your classic Hemi with these custom license plate frames, featuring bright white lettering on your choice of black, blue, or red background. Manufactured with top mounting holes to fit any model and are triple chrome plated for rust prevention. Made in USA.

Note: Please add two-digit year suffix to the end of part number and an A for black, B for blue or C for red. Example: LF12265A = 1966 HEMI in black.
LF1222 1960-76..... 14.99 ea



LF14201A



LF14212C

Hemi/Model Frames



Custom license plate frames, featuring bright white lettering on your choice of black, blue, or red background. Manufactured with top mounting holes to fit any model and are triple chrome plated for rust prevention. Made in USA.

Note: Please add an A for black, B for blue or C for red. Example: LF14201A = HEMI Dodge in black.

Hemi	
LF14201	Dart..... 14.99 ea
LF14204	Coronet..... 14.99 ea
LF14205	Charger..... 14.99 ea
LF14206	Super Bee..... 14.99 ea
LF14207	Challenger..... 14.99 ea
LF14212	Barracuda..... 14.99 ea
LF14213	Cuda..... 14.99 ea
LF14214	Belvedere..... 14.99 ea
LF14215	GTx..... 14.99 ea
LF14216	Road Runner..... 14.99 ea
LF14217	Satellite..... 14.99 ea



LF152091



LF152102

Mopar High Impact Colors



Seat Pack/Rapid Transit Frames

Does your Dodge belong to the Seat Pack Club? Perhaps your Plymouth has the Rapid Transit System? Proudly display your Mopar pride with these custom license plate frames, available in a variety of High-Impact colors. Made in USA.

Dodge Seat Pack		Plymouth Rapid Transit	
LF152091	Plum Crazy Purp 24.99 ea	LF152101	In-Violet..... 24.99 ea
LF152092	Go Mango..... 24.99 ea	LF152102	Vitamin C..... 24.99 ea
LF152093	Sub-Lime..... 24.99 ea	LF152103	Lime Light..... 24.99 ea
LF152094	Top Banana..... 24.99 ea	LF152104	Lemon Twist..... 24.99 ea
LF152095	Hemi Orange..... 24.99 ea	LF152105	Tor-Red..... 24.99 ea
LF152096	Butterscotch..... 24.99 ea	LF152106	Bahama Yellow..... 24.99 ea
LF152097	Citrus Yellow..... 24.99 ea	LF152107	Curious Yellow..... 24.99 ea
LF152098	Black/Silver..... 24.99 ea	LF152108	Black/Silver..... 24.99 ea



Year/Model & Make/Model Frames



Faunt your Mopar pride with a custom license plate frame that shows off your vehicle year and model or make and model. Available for most 1960-76 models, with top mounting holes to fit any year. All license plate frames are manufactured in the USA and are produced in die-cast zinc with an elegant, rust-preventive triple chrome plating. Choose from a black, blue or red background with bright white lettering.

Model Codes

01	DART	02	Dodge Demon	03	DART Swinger
04	CORONET	05	Charger	06	SUPER BEE
07	Challenger	08	POLARA	09	DODGE
08	Mopar	10	VALIANT	11	Barracuda
12	Cuda	13	Bahama	14	GTx
15	road runner	16	Satellite	17	DUSTER
18	FURY	19	SPORT FURY	20	PLYMOUTH
21	HEMI				

Year/Model Frame

Note: Available in a variety of years and models. Specify your choice of color A-Black, B-Blue, C-Red.



LF120160A



LF120570C



LF120566B



LF121160A

Make/Model Frame

Note: Available in a variety of models. Specify your choice of color A-Black, B-Blue, C-Red.



LF13203B



LF13205C



LF13216A



LF13222A

How to Order Year/Model Frame:

Please select model by adding two digit model code to the part number followed by two-digit year suffix and finally the alpha color code A - Black, B - Blue, C - Red

LF12 01 60 A = Dodge Dart, 1960, Black

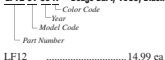

How to Order Model/Model Frames:

Please select model by adding two digit model code to the part number followed by two-digit year suffix and finally the alpha color code A - Black, B - Blue, C - Red

LF132 01 A = Dodge Dart, Black

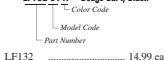



Year/Make Frames

Display the year and make of your Mopar as well as your pride! These frames feature bright white lettering on your choice of black, blue, or red background. These steel license plate frames are manufactured with top mounting holes to fit any model and are triple chrome plated for rust prevention. Made in the USA.

Note: Please add two-digit year suffix to the end of part number and an A for black, B for blue or C for red. Example: LF120960A = 1960 Dodge in black.

LF1210	1960-76	Mopar.....	14.99 ea
LF1209	1960-76	Dodge.....	14.99 ea
LF1221	1960-76	Plymouth.....	14.99 ea



Chrome License Plate Frames

All chrome license plate frames are just what you'll need when replacing a license plate or just looking for something special for your ride. Each frame is manufactured in highly polished chrome and available in several different type styles.

E9032346	Cuda 340.....	29.99 ea	E9032307	Charger R/T.....	29.99 ea
E9032347	Cuda 383.....	29.99 ea	E9032312	Daytona.....	29.99 ea
E9032348	Cuda 440-6.....	29.99 ea	E9032310	Dart.....	29.99 ea
E9032300	Barracuda.....	29.99 ea	E9032316	Duster.....	29.99 ea
E9032301	Cuda.....	29.99 ea	E9032314	Demon.....	29.99 ea
E9032340	340 Magnum.....	29.99 ea	E9032302	Challenger R/T.....	29.99 ea
E9032341	383 Magnum.....	29.99 ea	E9032303	Challenger R/T.....	29.99 ea
E9032342	440 Magnum.....	29.99 ea	E9032329	426 Hemi-reverse.....	29.99 ea
E9032322	Plymouth-script.....	29.99 ea	E9032327	426 Hemi.....	29.99 ea
E9032320	Plymouth-block.....	29.99 ea	E9032330	Hemi.....	29.99 ea
E9032318	GTX.....	29.99 ea	E9032332	Hemi - reverse.....	29.99 ea
E9032419	Dodge.....	29.99 ea			
E9032306	Charger.....	29.99 ea			



Mopar License Plate Official Licensed Product Collection

The Mopar license plate collection featuring vintage logos from the 60s and 70s muscle car era. These are official 6" x 12" license plates are made from high quality heavy gauge aluminum plates covered with vivid graphics applied to 3M reflective sheeting making plates highly visible and give you outstanding durability. These plate logos are embossed to provide increased strength. These are as thick as your state plate and they meet all government specifications for registered vehicle license plates.

MN1770	Road Runner.....	12.99 ea
MN1898	426 Hemi Cuda.....	18.99 ea
MN1900	Cuda fish.....	18.99 ea
MN1901	Demon.....	18.99 ea
MN1903	Dodge Scat Pack.....	18.99 ea
MN1904	Dodge Triad Symbol.....	18.99 ea
MN1905	Duster.....	18.99 ea
MN1906	Plymouth GTX.....	18.99 ea
MN1907	Pentastar.....	18.99 ea
MN1908	Plymouth Rapid Transit System.....	18.99 ea
MN1909	Plymouth logo.....	18.99 ea
MN1910	R/T logo.....	18.99 ea
MN1911	Shaker logo.....	18.99 ea
MN1912	Super Bee.....	18.99 ea
MN1969	Plymouth makes it.....	18.99 ea
MN2071	Plymouth heart.....	18.99 ea



Flips out to display front plate while driving



Folds up out of view to hide unsightly plate during car show.

Show & Go License Plate Transport

This Show & Go license plate transport installs below the bumper or valance panel to display the license plate on the front of your vehicle or hide it for shows. This retractable license plate holder is perfect for any show vehicle.

A400	53.99 ea
------	-------	----------

Automotive Manuals

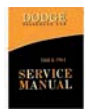

L2100



L2110



L2114



L2119



L2120



L2124



L1110



L1116



L1119



L1125



L1129



L1133



L1134



L1136



L1139



L1151



L1154



L1160



L1162



L1171



L1179



L1185



L1191



L1195



L1199



L1204

1960-76 Mopar Owners Manuals

1960-76 Dodge and Plymouth owners manuals. Sometimes called an "operating manual," these are the manuals that are typically found in the vehicle's glove box. They are used to acquaint the owner with the operating controls of the vehicle and recommends certain maintenance and minor service procedures. Provides brief specifications, capacities and other service information.

1960-76 Shop Manuals

Dodge shop manuals which cover body, chassis and mechanical service on 1960-76 models. Includes sections on the engine, transmission, suspension, brakes, driveline, electrical, doors, windows, etc. They also include wiring diagrams. Text, accompanied by diagrams or illustrations, explains how to disassemble, repair and reassemble the various components and frequently include troubleshooting information.

Dodge

L2100	1960-61	Dodge (exc. Lancer).....	64.99 ea
L2101	1962	Lancer, Dart Polara.....	64.99 ea
L2102	1963	Dodge.....	64.99 ea
L2103	1964	440, 330, Dart.....	64.99 ea
L2104	1965	880, Monaco, Polara.....	64.99 ea
L2105	1965	Coronet, Dart.....	64.99 ea
L2106	1966	Charger (seps to L2108).....	19.99 ea
L2107	1966	Charger, Coronet, Dart.....	64.99 ea
L2108	1966	Monaco, Polara.....	64.99 ea
L2109	1967	Charger, Coronet, Dart.....	64.99 ea
L2110	1968	Charger, Coronet, Dart.....	64.99 ea
L2111	1969	Charger, Coronet, Dart.....	64.99 ea
L2112	1969	Monaco, Polara.....	64.99 ea
L2113	1970	Challenger, Dart.....	64.99 ea
L2114	1970	Charger, Coronet.....	64.99 ea
L2115	1970	Monaco, Polara.....	64.99 ea
L2116	1971	all.....	94.99 ea
L2117	1972	all.....	84.99 ea
L2118	1973	all.....	84.99 ea
L2119	1974	all.....	99.99 ea

Plymouth

L2120	1963	all.....	59.99 ea
L2121	1964	all.....	59.99 ea
L2122	1965	all.....	59.99 ea
L2123	1966	all.....	64.99 ea
L2124	1967	all.....	69.99 ea
L2125	1968	all.....	69.99 ea
L2126	1969	all.....	74.99 ea
L2127	1970	all exc. RR/Superbird	89.99 ea
L2127A	1970	RR/Superbird	19.99 ea
L2128	1971	all.....	99.99 ea
L2129	1972	all.....	94.99 ea
L2130	1973	all.....	94.99 ea
L2131	1974	all.....	99.99 ea
L2132	1975	all.....	99.99 ea
L2133	1976	all.....	99.99 ea

Dodge

L1110	1960	Dodge.....	19.99 ea
L1111	1961	Dart & Polara.....	19.99 ea
L1112	1961	Lancer.....	14.99 ea
L1113	1961	Dodge.....	19.99 ea
L1114	1962	Dart.....	19.99 ea
L1115	1962	Lancer.....	19.99 ea
L1116	1963	Dodge.....	19.99 ea
L1117	1964	Dart.....	19.99 ea
L1118	1965	880, Monaco, Polara.....	19.99 ea
L1119	1965	Coronet.....	19.99 ea
L1120	1965	Dart.....	19.99 ea
L1121	1966	Charger.....	19.99 ea
L1122	1966	Coronet.....	19.99 ea
L1123	1966	Dart.....	19.99 ea
L1124	1966	Polara, Monaco.....	19.99 ea
L1125	1967	Charger.....	19.99 ea
L1126	1967	Dart.....	19.99 ea
L1127	1968	Charger.....	19.99 ea
L1128	1968	Coronet.....	19.99 ea
L1129	1968	Dart.....	19.99 ea
L1130	1968	Polara, Monaco.....	19.99 ea
L1131	1969	Charger.....	14.99 ea
L1132	1969	Coronet.....	19.99 ea
L1133	1969	Dart.....	19.99 ea
L1134	1969	Polara, Monaco.....	19.99 ea
L1135	1970	Challenger.....	19.99 ea
L1136	1970	Charger.....	19.99 ea
L1137	1970	Coronet.....	19.99 ea
L1138	1970	Dart.....	19.99 ea
L1139	1971	Challenger.....	15.99 ea
L1140	1971	Coronet & Charger.....	19.99 ea
L1141	1971	Dart & Demon.....	19.99 ea
L1142	1972	Challenger.....	19.99 ea
L1143	1972	Coronet & Charger.....	19.99 ea
L1144	1972	Dart & Demon.....	19.99 ea
L1145	1972	Monaco, Polara.....	19.99 ea
L1146	1973	Challenger.....	19.99 ea
L1147	1973	Charger, Coronet.....	19.99 ea
L1148	1973	Dart.....	19.99 ea
L1149	1973	Polara & Monaco.....	14.99 ea
L1150	1974	Challenger.....	19.99 ea
L1151	1974	Charger & Coronet.....	19.99 ea
L1152	1974	Dart.....	19.99 ea

Plymouth

L1153	1960	Plymouth.....	19.99 ea
L1154	1960	Valiant.....	19.99 ea
L1155	1961	Plymouth.....	19.99 ea
L1156	1961	Valiant.....	19.99 ea
L1157	1962	Valiant.....	19.99 ea
L1158	1962	Plymouth.....	19.99 ea
L1159	1963	Valiant.....	19.99 ea
L1160	1963	Plymouth.....	19.99 ea
L1161	1963	Plymouth 426 Supp.....	19.99 ea
L1162	1964	Plymouth.....	19.99 ea
L1163	1964	Valiant.....	19.99 ea
L1164	1964	Plymouth 426 Supp.....	19.99 ea
L1165	1965	Valiant & Barracuda.....	19.99 ea
L1166	1965	Belvedere.....	19.99 ea
L1167	1965	Super Commando 426.....	19.99 ea
L1168	1966	Barracuda.....	19.99 ea
L1169	1966	Belvedere & Satellite.....	19.99 ea
L1170	1966	Valiant.....	19.99 ea
L1171	1966	Barracuda.....	19.99 ea
L1172	1967	Barracuda.....	19.99 ea
L1174	1967	Belvedere.....	19.99 ea
L1177	1967	Valiant.....	19.99 ea
L1178	1968	Belvedere.....	19.99 ea
L1179	1968	Barracuda.....	19.99 ea
L1180	1968	Valiant.....	19.99 ea
L1181	1969	Barracuda.....	19.99 ea
L1182	1969	Satellite.....	19.99 ea
L1183	1969	Valiant.....	19.99 ea
L1185	1970	Barracuda.....	19.99 ea
L1186	1970	Belvedere.....	19.99 ea
L1187	1970	Duster & Valiant.....	19.99 ea
L1189	1971	Barracuda.....	14.99 ea
L1190	1971	Satellite.....	19.99 ea
L1191	1971	Duster & Valiant.....	19.99 ea
L1193	1972	Satellite.....	19.99 ea
L1194	1972	Barracuda.....	19.99 ea
L1195	1972	Barracuda.....	19.99 ea
L1197	1973	Barracuda.....	19.99 ea
L1198	1973	Duster & Valiant.....	19.99 ea
L1199	1973	Satellite.....	19.99 ea
L1200	1974	Duster & Valiant.....	19.99 ea
L1201	1974	Satellite.....	19.99 ea
L1202	1974	Barracuda.....	19.99 ea
L1204	1975	Valiant.....	14.99 ea
L1205	1976	Duster & Valiant.....	14.99 ea

Automotive Manuals



1960-76 Factory Shop Manuals on CD Rom

The information provided on each CD-ROM includes virtually all the information you'll find in a factory shop manual. This unique concept gives you the ability to view on your personal computer, complete factory technical information on the make and model of your vehicle. You can print out just that portion of the manual that's needed, or go to the index and type in the part that you're trying to locate. If several manuals are required for a particular make and model, all are supplied on a single CD for your convenience.

Note: CD's are non-returnable once opened.

Dodge Models

CDM6701	1960-61	all	49.99	ea
CDM6702	1962	all	49.99	ea
CDM6703	1963	all	49.99	ea
CDM6704	1964	all	49.99	ea
CDM6705	1965	all	49.99	ea
CDM6706	1966	all	49.99	ea
CDM6707	1967	all	49.99	ea
CDM6708	1968	all	49.99	ea
CDM6709	1969	all	49.99	ea
CDM6710	1970	Challenger, Dart, Polara, Monaco	49.99	ea
CDM6711	1970	Charger, Coronet	49.99	ea
CDM6712	1971	all	49.99	ea
CDM6713	1972	all	49.99	ea
CDM6714	1973	all	49.99	ea
CDM6715	1974	all	49.99	ea
CDM6815	1975	Plymouth/Chrysler/Dodge	49.99	ea
CDM6816	1976	Plymouth/Chrysler/Dodge	49.99	ea

Plymouth Models

CDM6801	1960-61	all	49.99	ea
CDM6802	1962	all	49.99	ea
CDM6803	1963	all	49.99	ea
CDM6804	1964	all	49.99	ea
CDM6805	1965	all	49.99	ea
CDM6806	1966	all	49.99	ea
CDM6807	1967	all	49.99	ea
CDM6808	1968	all	49.99	ea
CDM6809	1969	all	49.99	ea
CDM6810	1970	all	49.99	ea
CDM6811	1971	all	49.99	ea
CDM6812	1972	all	49.99	ea
CDM6813	1973	all	49.99	ea
CDM6814	1974	all	49.99	ea
CDM6815	1975	Plymouth/Chrysler/Dodge	49.99	ea
CDM6816	1976	Plymouth/Chrysler/Dodge	49.99	ea

Plymouth Performance Package Booklet

This pamphlet details the performance options available on 1969 Road Runner, GTX, and Barracuda models. Includes information on high-performance, engine, suspension, and exhaust packages.



6.99 ea

1966 Plymouth Hemi Sales Folder

This 9-page sales folder shows what made the "Hemi" engine so hot! From engine specifications to valve design, this folder explains why the "Hemi" engine was ahead of its class.



11.99 ea



1965-74 Reprinted Vintage New Car Sales Brochures

Does your finished restoration look showroom new? There's no better complement to your restoration than a new car sales brochure! These are reprints of the original showroom brochures that were issued to prospective buyers when the vehicles were new. Each brochure is printed on correct original stock paper including correct colors and type fonts. See for yourself exactly what the factory was offering when your Dodge, Chrysler, or Plymouth was new! Page count varies by year.

L3001	1965	Coronet	7.99	ea
L3059	1966	Hemi	11.99	ea
L3003	1966	Charger	7.99	ea
L3004	1966	Coronet	7.99	ea
L3005	1967	Coronet	7.99	ea
L3006	1967	Charger	7.99	ea
L3007	1967	Dart	7.99	ea
L3008	1968	Belvedere/Road Runner/GTX/Satellite	7.99	ea
L3009	1968	Charger/RT	7.99	ea
L3010	1968	Coronet/RT	7.99	ea
L3011	1968	Dart/GT/GTS	7.99	ea
L3012	1969	Belvedere/GTX/Road Runner/Satellite	7.99	ea
L3013	1969	Charger/RT/500	7.99	ea
L3014	1969	Coronet/RT/Super Bee	7.99	ea
L3015	1969	Dart/Swinger/GT	7.99	ea
L3016	1970	Charger	7.99	ea
L3017	1970	Coronet/Super Bee	7.99	ea
L3018	1970	Challenger	7.99	ea
L3019	1970	Dart	7.99	ea
L3020	1970	Challenger TA sales specification folder	11.99	ea
L3021	1970	Super Bee (sales folder)	9.99	ea
L3022	1970	Belvedere/GTX/Satellite/Road Runner	7.99	ea
L3023	1970	Barracuda	7.99	ea
L3024	1970	Challenger	7.99	ea
L3025	1971	Charger/Super Bee/RT	7.99	ea
L3026	1971	Challenger/RT	7.99	ea
L3027	1972	Challenger	7.99	ea
L3028	1972	Charger	7.99	ea
L3029	1972	Dart/Bonnet/Swinger	7.99	ea
L3030	1974	Challenger	7.99	ea
L3031	1974	Dart/Sport/Swinger	7.99	ea
L3032	1974	Charger	7.99	ea

Automotive Manuals

1964-65 Hemi Owner's Manuals

Excellent reprints of the original 1964-65 Hemi owner's manuals using exact colors, correct paper and original printing techniques.



L3033 1964 426 Hemi..... 11.99 ea
L3034 1965 426 Hemi..... 11.99 ea

1960-74 Mopar Dealer Parts Catalogs

Complete illustrated Dealer Parts Catalog that include body and chassis, text and illustration for every major part on the car. The text section gives you the part number, common name and application. The illustration section gives you labeled "exploded views" of the parts, showing what they look like and how they fit together with adjacent parts.

Note: Does not include Dodge dealer parts. These manuals are unbound.

Chrysler, Dodge, Imperial and Plymouth Dealer Parts

L1206 1961..... 89.99 ea
L1207 1961..... 89.99 ea
L1208 1962..... 89.99 ea
L1209 1963..... 89.99 ea
L1210 1964..... 99.99 ea
L1211 1965..... 99.99 ea
L1212 1966..... 99.99 ea
L1213 1967..... 99.99 ea
L1214 1968..... 99.99 ea
L1215 1969..... 99.99 ea
L1216 1970-71..... 119.99 ea
L1217 1972..... 89.99 ea
L1218 1973..... 89.99 ea
L1219 1974..... 89.99 ea



Hemi Service Bulletins

These Service Bulletin manuals are excellent reprints of the originals using exact colors, correct paper, and original printing techniques.

L3048 1964-66 426 Hemi..... 13.99 ea
L3058 1965 Hemi Coronet Manual..... 9.99 ea
L3049 1966 Belvedere Hemi HP2..... 13.99 ea
L3050 1967 Coronet 426 B..... 11.99 ea
L3057 Street Hemi bulletin..... 7.99 ea

1967-76 Dodge Dart & Plymouth Valiant Manual

Haynes manuals are a series of practical manuals aimed at both the do-it-yourselfer and professional garage mechanics. Primarily focused on maintenance and repair of your classic Mopar, this manual covers Dodge Dart, Demon, Plymouth Valiant, Duster & Barracuda (1967 thru 1969) and 6 cylinder engines for 1967 thru 1976. With a Haynes manual, you can do it yourself - from basic maintenance to in-depth repairs. Based on a complete teardown of the vehicle. Clear instructions and hundreds of photographs show each step. Whether you're a beginner or a pro, this book will be a big help to you.

L1242 1967-76..... 29.99 ea

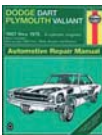

1971-89 Mopar Rear-Wheel Drive Vehicles Manual

Haynes manuals are a series of practical manuals aimed at both the do-it-yourselfer and professional garage mechanics. Primarily focused on maintenance and repair of your classic Mopar, this manual covers Dodge, Plymouth and Chrysler vehicles from 1971 through 1989. With a Haynes manual, you can do it yourself - from basic maintenance to in-depth repairs. Based on a complete teardown of the vehicle. Clear instructions and hundreds of photographs will show each step.

L1241 1971-89..... 29.99 ea



1971 Drag Racing Parts Catalog

This reprint of the 1971 Drag Racing Parts Catalog details a complete list of parts available from Chrysler Motors for the modification of Mopar vehicles in sanctioned off the highway drag racing events. 8-1/2" x 11", 56 pages, black and white illustrated.

L3053 1971..... 16.99 ea



Performance Tuning and Modification Tips

These reprinted booklets contain Dodge Engineering's tuning and modification tips for extracting more performance from Hemi and "B" series wedge engines.

L3054 Dodge "B" Series Engines..... 8.99 ea
L3055 Hemi..... 8.99 ea



Hustle Stuff High-Performance Parts/Modifications Catalogs

These reprinted 1970-71 Hustle Stuff catalogs from Chrysler are guides to modifying your engine for extra performance without losing drivability. Details modifications that require only basic tools, such as ball-on induction components. 8-1/2" x 11", black and white illustrated.

L3051 1970..... 13.99 ea
L3052 1971..... 13.99 ea



1966-74 Mopar Wiring Diagrams

Need to rewire your classic Mopar vehicle? Classic Industries® has the answer. These manuals contain wiring diagrams that cover body and engine wiring configurations and show the various electrical circuits, fuses, distributor, etc.

L1220 1966 Charger..... 9.99 ea
L1221 1966 Coronet..... 14.99 ea
L1222 1967 Charger..... 9.99 ea
L1223 1967 Coronet..... 9.99 ea
L3035 1967 Valiant..... 7.99 ea
L1224 1967 Dart..... 9.99 ea
L3044 1968 Plymouth B-Body..... 7.99 ea
L1226 1968 Charger..... 9.99 ea
L1227 1968 Coronet..... 9.99 ea
L3036 1968 Valiant..... 7.99 ea
L1228 1968 Dart..... 9.99 ea
L3045 1969 Plymouth B-Body..... 7.99 ea
L1229 1969 Charger..... 9.99 ea
L1230 1969 Coronet & Super Bee..... 9.99 ea
L3037 1969 Valiant..... 7.99 ea
L1231 1969 Dart..... 9.99 ea
L3041 1969 Barracuda..... 7.99 ea
L3046 1970 Plymouth B-Body..... 7.99 ea
L1232 1970 Challenger..... 9.99 ea
L1233 1970 Charger..... 9.99 ea
L1234 1970 Coronet & Super Bee..... 9.99 ea
L3042 1970 Cuda..... 7.99 ea
L3038 1970 Valiant/Duster..... 7.99 ea
L1235 1970 Dart..... 9.99 ea
L1237 1970 Challenger..... 9.99 ea
L1238 1971 all A-Body..... 9.99 ea
L1239 1971 Challenger..... 9.99 ea
L1237 1971 Charger & Coronet..... 9.99 ea
L3043 1971 Cuda..... 7.99 ea
L3039 1971 Valiant/Duster..... 7.99 ea
L1238 1971 Dart..... 9.99 ea
L1239 1971 all A-Body..... 9.99 ea
L3040 1973 all A-Body..... 7.99 ea
L1240 1974 all A-Body..... 9.99 ea

Laminated Wiring Diagrams

If you are tired of trying to decipher black and white wiring diagrams from old shop manuals, here is the solution! These full color diagrams feature all chassis wiring from the front lights to the dash to rear lights. Laminated in heavy plastic for durability and to prevent grease smudges. Redo your wiring the easy way...

in color! Available as a small diagram measuring 8-1/2" x 11" (one page double sided) or a large diagram measuring 11" x 17".
Note: Specify (A) for 8-1/2" x 11" or (B) for 11" x 17".

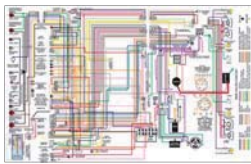
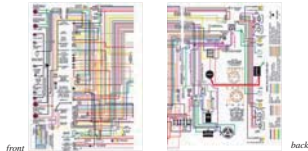

1962-76 Dodge A-Body Diagrams

Note: Specify (A) for 8-1/2" x 11" or (B) for 11" x 17".

Part#	Year	Model	8 1/2" x 11"	11" x 17"
ML13011	1962	Lancer	16.99	21.99
ML13012	1963	Dart	16.99	21.99
ML13013	1964	Dart	16.99	21.99
ML13016	1965	Dart	16.99	21.99
ML13019	1966	Dart	16.99	21.99
ML13023	1967	Dart	16.99	21.99
ML13027	1968	Dart	16.99	21.99
ML13032	1969	Dart	16.99	21.99
ML13040	1970	Dart	16.99	21.99
ML13041	1970	Dart w/rallye dash	16.99	21.99
ML13047	1971	Dart	16.99	21.99
ML13048	1971	Dart w/rallye dash	16.99	21.99
ML13053	1972	Dart	16.99	21.99
ML13058	1973	Dart	16.99	21.99
ML13063	1974	Dart	16.99	21.99
ML13065	1975	Dart	16.99	21.99
ML13066	1976	Dart	16.99	21.99

1962-75 Dodge B-Body Diagrams

Note: Specify (A) for 8-1/2" x 11" or (B) for 11" x 17".

Part#	Year	Model	8 1/2" x 11"	11" x 17"
ML13010	1962	Dart	16.99	21.99
ML13014	1964	Polara	16.99	21.99
ML13015	1965	Coronet	16.99	21.99
ML13017	1966	Charger	16.99	21.99
ML13018	1966	Coronet	16.99	21.99
ML13021	1967	Charger	16.99	21.99
ML13022	1967	Coronet	16.99	21.99
ML13026	1968	Charger	16.99	21.99
ML13025	1968	Coronet/Super Bee	16.99	21.99
ML13031	1969	Charger	16.99	21.99
ML13029	1969	Coronet/Super Bee	16.99	21.99
ML13030	1969	Coronet/Super Bee w/rallye dash	16.99	21.99
ML13036	1970	Charger	16.99	21.99
ML13035	1970	Coronet/Super Bee w/rallye dash	16.99	21.99
ML13045	1971	Charger/Super Bee	16.99	21.99
ML13046	1971	Charger/Super Bee w/rallye dash	16.99	21.99
ML13049	1972	Charger	16.99	21.99
ML13050	1972	Charger w/rallye dash	16.99	21.99
ML13054	1973	Charger	16.99	21.99
ML13055	1973	Charger w/rallye dash	16.99	21.99
ML13059	1974	Charger	16.99	21.99
ML13060	1974	Charger w/rallye dash	16.99	21.99
ML13064	1975	Charger	16.99	21.99

1970-74 Dodge E-Body Diagrams

Note: Specify (A) for 8-1/2" x 11" or (B) for 11" x 17".

Part#	Year	Model	8 1/2" x 11"	11" x 17"
ML13037	1970	Challenger	16.99	21.99
ML13038	1970	Challenger w/rallye dash	16.99	21.99
ML13039	1970	Challenger w/Hemi	16.99	21.99
ML13042	1971	Challenger	16.99	21.99
ML13043	1971	Challenger w/rallye dash	16.99	21.99
ML13044	1971	Challenger w/Hemi	16.99	21.99
ML13051	1972	Challenger	16.99	21.99
ML13052	1972	Challenger w/rallye dash	16.99	21.99
ML13056	1973	Challenger	16.99	21.99
ML13057	1973	Challenger w/rallye dash	16.99	21.99
ML13061	1974	Challenger	16.99	21.99
ML13062	1974	Challenger w/rallye dash	16.99	21.99

1962-76 Plymouth A-Body Diagrams

Note: Specify (A) for 8-1/2" x 11" or (B) for 11" x 17".

Part#	Year	Model	8 1/2" x 11"	11" x 17"
ML13068	1962	Valiant	16.99	21.99
ML13070	1964	Barracuda, Valiant	16.99	21.99
ML13072	1965	Barracuda, Valiant	16.99	21.99
ML13075	1966	Barracuda	16.99	21.99
ML13078	1966	Valiant	16.99	21.99
ML13079	1967	Barracuda	16.99	21.99
ML13082	1968	Barracuda	16.99	21.99
ML13085	1969	Barracuda	16.99	21.99
ML13088	1969	Valiant	16.99	21.99
ML13093	1970	Duster	16.99	21.99
ML13094	1970	Duster w/rallye dash	16.99	21.99
ML13102	1971	Duster	16.99	21.99
ML13093	1971	Duster w/rallye dash	16.99	21.99
ML13053	1972	Duster	16.99	21.99
ML13058	1973	Duster	16.99	21.99
ML13063	1974	Duster	16.99	21.99
ML13065	1975	Duster	16.99	21.99
ML13066	1976	Duster	16.99	21.99

1962-76 Plymouth B-Body Diagrams

Note: Specify (A) for 8-1/2" x 11" or (B) for 11" x 17".

Part#	Year	Model	8 1/2" x 11"	11" x 17"
ML13067	1962	B-Body	16.99	21.99
ML13069	1963	B-Body	16.99	21.99
ML13071	1964	B-Body	16.99	21.99
ML13073	1965	B-Body	16.99	21.99
ML13076	1966	B-Body	16.99	21.99
ML13080	1967	B-Body	16.99	21.99
ML13083	1968	B-Body	16.99	21.99
ML13086	1969	B-Body	16.99	21.99
ML13091	1970	B-Body	16.99	21.99
ML13092	1970	B-Body w/rallye dash	16.99	21.99
ML13097	1970	B-Body w/Hemi	16.99	21.99
ML13100	1971	B-Body	16.99	21.99
ML13101	1971	B-Body w/rallye dash	16.99	21.99
ML13108	1972	B-Body	16.99	21.99
ML13109	1972	B-Body w/rallye dash	16.99	21.99
ML13113	1973	B-Body	16.99	21.99
ML13114	1973	B-Body w/rallye dash	16.99	21.99
ML13118	1974	B-Body	16.99	21.99
ML13119	1974	B-Body w/rallye dash	16.99	21.99

1970-74 Plymouth E-Body Diagrams

Note: Specify (A) for 8-1/2" x 11" or (B) for 11" x 17".

Part#	Year	Model	8 1/2" x 11"	11" x 17"
ML13089	1970	Barracuda	16.99	21.99
ML13090	1970	Barracuda w/rallye dash	16.99	21.99
ML13096	1970	Hemi Cuda	16.99	21.99
ML13097	1971	Barracuda	16.99	21.99
ML13099	1971	Barracuda w/rallye dash	16.99	21.99
ML13107	1971	Hemi Cuda	16.99	21.99
ML13105	1972	Barracuda	16.99	21.99
ML13106	1972	Barracuda w/rallye dash	16.99	21.99
ML13111	1973	Barracuda	16.99	21.99
ML13112	1973	Barracuda w/rallye dash	16.99	21.99
ML13116	1974	Barracuda	16.99	21.99
ML13117	1974	Barracuda w/rallye dash	16.99	21.99

Automotive Literature

The Hemi in the Barn: More Great Stories of Automotive Archaeology

More than forty new stories of amazing finds and automotive resurrections. Avid collectors big and small recall the thrills of the hunt, the tips and hunches



followed, clues pursued, the heart-stopping payoff. There was a Plymouth Superbird found buried in a hedge out of sight in Alabama. There's the find of legendary race builder Smokey Yunick's Boss 302 Trans-Am car. As entertaining as these tales are and some are truly corkers, they're also full of tantalizing hints and suggestions for readers setting off on their own adventures in automotive archaeology. 6" x 9", 256 pages. L10412 paperback 19.99 ea

Dodge Dynamite!

An action-packed story of how Dodge came about and how it became the car to beat. High-octane images show the record-breakers, film stars, racecars and concepts, doing what Dodge does best - going faster than anyone else, in superb style. Softbound, 8-1/8" x 9-7/8", 175 pages. L1046 29.99 ea



Barracuda Muscle Portfolio 1964-1974

Covers Plymouth Barracuda 1964 to 1974, including Formula S, Cuda 340, 383, 440, AAR, Hemi and Six Pack. Includes driving impressions, first drives, road tests, comparison tests, long-term tests, handling and more. Thirty-five articles from the pages of Car and Driver, Motor Trend, Road & Track, Sports Car Graphic, Car Life and many others. Softbound, 8-1/2" x 11" 140 pages. L1059 24.99 ea

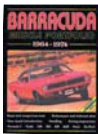

Charger Muscle Portfolio 1966-74

Complete with road tests, comparison tests and hundreds of articles on Dodge Chargers from 1966 to 1974! Softbound, 8" x 10-3/4", 140 pages. L1007 24.99 ea



Proving Ground: A History of Dodge, Chrysler and Plymouth Racing

From the early decades of the Indy 500 to the modern super-speedways of NASCAR, from the 24 Hours of Le Mans sports car race to drag racing's 4.5-second quarter-mile runs, this is the story of one company's pursuit of performance and the glory that came with it. Full of hundreds of color and black and white photos, we hear tales of the Hemi, the Superbird, Don Garlits, Richard Petty and many other legends. Noted author and Chrysler enthusiast Jim Schild tells the whole MOPAR story, from door-banging Trans Am racing, to land speed records on the salt flats of Bonneville, from the legendary C-300 to the road-shredding Dodge Viper. Hardbound, 9-1/4" x 10-7/8", 192 pages. L1045 39.99 ea

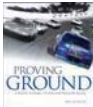

Chrysler Road Test Book: Valiant 1960-62

The Valiant was introduced by Chrysler in the compact car category to rival the Corvair and Falcon. Reaction to the styling was ambivalent but all agreed that the engine and transmission were good. A Station Wagon was introduced the following year. By 1962 there were seven models with many improvements under the skin including a larger fuel tank. This is a book of contemporary road test, technical and specification data, model introductions, drivers impressions, long-term tests, racing. Models covered include: V200 Station Wagon, V200, Signet 200, 170, S Automatic, R & S Series. Softbound, 7-3/4" x 10-3/4", 100 pages. L1010 19.99 ea

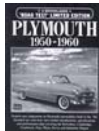
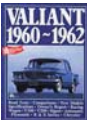

Plymouth 1950-60

Road and comparison tests, specs, model introductions, performance data and owners reports for the Belvedere, Cambridge, Cranbrook, Fury, Plaza, Savoy and Suburban Wagon. Softbound, 8" x 10-3/4", 92 pages. L1037 19.99 ea



Plymouth Fury 1956-1976

Road and comparison tests, specs, model introductions, performance data and owners reports for the Fury I, II, III, Sport, VIP Gran Coupe & sedan with convertible and wagon variations. Softbound, 8" x 10-3/4", 136 pages. L1008 29.99 ea



Dodge Dart 1960-76

Includes road and comparison tests plus technical reports, performance data and specifications on the Custom, Demon, GT, GTS, Phoenix, Pioneer, Ramcharger, Sececa, Sport, SE, Swinger, 270, 330, 440 and the D-500 Sedan, Coupe, Wagon and Convertible. 39 articles are sourced from Automobile Topics, Autopost, Buyers Guide, Car and Driver, Car Craft, Car Facts, Car Guide, Car Life, Cars, High Performance Cars, Hot Rod, Motor Life, Motor Trend, Motorcycle and Road Test. Softbound, 8" x 10-1/2", 136 pages. L1003 29.99 ea



Plymouth Muscle Portfolio

This story of Plymouths muscle cars told through road tests and contemporary articles. Fully reported on are the Barracuda with the formidable Formula S package plus the Belvedere Satellite, GTX and Road Runner. Also covered are the Duster and Sport Fury and the legendary V8 Hemi and Magnum Power plants. Included are full specifications and performance data. Softbound, 8" x 11", 136 pages. L1011 24.99 ea



The Complete Book of Classic Dodge and Plymouth Muscle

This gorgeously illustrated work takes readers the curtain down on American muscle car production. With extensive details, specs, and spectacular photographs, this book stands alone as the ultimate resource on America's muscle cars. Flexibound, 288 pages, 9-1/4" x 10-5/8". L44774 34.99 ea

Dodge Muscle Portfolio 1964-71

Fully Illustrated articles from the worlds leading automotive magazines deliver the information you're looking for. Each book in this popular series contains road tests, driving impressions, specs, technical data new model reports and comparison tests. Terrific references for enthusiasts restoring their cars to original condition. Softbound, 8" x 11", 136 pages. L1012 29.99 ea



Automotive Literature



Hemi Muscle Cars

Since the early years of the internal combustion engine, engineers recognized that the hemispherical head design, which utilized dome-shaped combustion chambers, generated phenomenal horsepower. After World War II, Chrysler applied this technology to a 330-cubic-inch V-8 destined for its 1951 production cars. This engine became so dominant on America's racetracks and boulevards that its nickname "Hemi" came to symbolize the ultimate in American performance. "Hemi Muscle Cars" tells the story of the magnificent Hemi-powered performance cars and explains why the Hemi has blown away the competition for six decades and still does so today. More importantly, the book shows how this potent engine became a cultural icon, how it came to define American performance cars. Hardcover, 10-1/2" x 12", 336 pages. L1043 49.99 ea

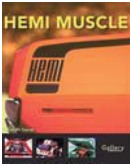

Hemi Muscle

In this value-priced celebration of Hemi muscle cars, author and photographer Robert Genat celebrates the word that has been synonymous with speed, power and muscle. Named for its hemispherically shaped combustion chambers, Chrysler's iconic engine has powered some of the most powerful automobiles down America's highways, drag strips and race tracks. This book on Hemi muscle cars profiles all of the great cars that have carried the Hemi badge, from muscle car legends like the Road Runner, Challenger, 'Cuda and Superbird to emerging legends like Dodge Hemi trucks and the next generation of Charger hitting the streets. Softbound, 6-1/2" x 8-1/4", 192 pages. L1039 39.99 ea

Challenger & Barracuda 1970-74

Renowned for their sleek shape and prodigious power, Mopar's Challenger and Barracuda were among the top cars of the muscle car era, generating a fervent following that continues to this day. Collectors Originality Guide Challenger and Barracuda 1970-1974 presents all the information you need regarding correct parts, finishes, options, and trim pieces for all the versions of the E-Body Dodge Challenger and Plymouth Barracuda, built from 1970 to 1974. Author, photographer, and MOPAR expert Jim Schild sorts out all of the details about these prized cars, including the dizzying variety of engine options. Filled with high-quality, detailed photos of excellent originals or very accurate restorations, this book is a resource that no E-Body enthusiast can do without. Softbound, 8-3/4" x 11-1/2", 128 pages. L1092 24.99 ea



Muscle Cars

Muscle Cars explores this era and the current models in a broad survey of classic muscle and today's new machines. Each chapter is organized around a theme (milestones, factory racers, etc), each model getting a multi-page spread of full-color photography, performance stats, trivia, and more. Photos and stories from the people who built and raced these amazing machines make the book a must-read for any fan of American muscle. Paperback, 240 pages, 6-1/2" x 8-1/4". L13877 19.99 ea



Street Machines: Classics, Muscle Cars, Modern

Any custom automotive project begins with making choices. There are choices under the hood, such as which engine will match well with a certain chassis and transmission. There are aesthetic choices, like whether to use custom or stock wheels, what paint scheme will look best, and what type of interior will be comfortable as well as eye catching. Street Machines: Classic, Muscle, Modern is the ideal resource for anyone looking to build a powerful and stylish modified street machine. Paperback, 160 pages, 8-1/4" x 10-5/8". L39077 24.99 ea



Virgil Exner: Visioneer

The official biography of the man who brought his own personal style to the world of industrial design. His thrilling automobile designs from the mid-fifties took the world by storm and put Chrysler at the top. With 150 color images throughout, this is a unique and fascinating insight into a pivotal player in the development of the modern automobile. Hardcover, 160 pages, 8" x 10". L41188 39.99 ea



Hemi: The Ultimate American V8

Take a high-octane tour through the design, development and muscle cars behind the greatest V-8 in Detroit history. Fire-breathing Mopars come roaring to life, from the 1951 Chrysler Saratoga through the muscle cars of the 1960s and 70s right up to the newest Hemis in Dodge's line of cars and pickups. Packed with facts and fascinating details, the book features cutaways of the most collectible Hemi-powered cars in history, as well as a look at Hemi clones and race cars. From the Hemi high-powered past to its scorching present, from its greatest racetrack feats to high-performance street achievements, this full-color, full-throttle history truly conveys the power of the ultimate American V-8. Softbound, 10" x 10", 168 pages. L1091 24.99 ea



Dodge 100 Years

In Dodge 100 Years, renowned automotive journalist Matt DeLorenzo provides an unrivaled chronicle of Dodge throughout the past century. Starting with the company's modest beginnings in the 1900s, DeLorenzo recounts the brothers' story from their decision to venture into full automotive manufacturing, to their untimely deaths in 1920, and finally the company's purchase by Chrysler in 1928. The Dodge story is not without its struggles: while the division played a key part in the muscle car wars of the 1960s and early '70s, the oil crisis of 1973 took its toll on Dodge and Chrysler as other manufacturers moved toward more efficient models. Hardcover, 10" x 12-1/4", 192 pages. L45528 44.99 ea

The Ultimate Guide to Muscle Cars

Muscle cars are loud, proud and in your face, with no other pretensions than to be just that. They may be simple, even crude, but for roaring, pumping, tire-smoking standing starts, they are the business. To the youth culture of America, raised on drag racing, red-light street racing and hot-rodding, they are irresistible. The late 1960s was the heyday of the muscle car, before soaring accident rates and insurance premiums, tougher safety and emissions legislation, and finally an oil crisis, made excessive horsepower seem irresponsible. They may be a little more high-tech, but muscle cars are definitely back with a vengeance! Hardcover, 448 pages, 11" x 8-1/2". L13730 24.99 ea



Top Muscle: The Rarest Cars from America's Fastest Decade

A muscle-car book unlike any other, featuring the rarest vehicles on Earth. Top Muscle chronicles the ultimate collection of these super-rare high-performance beasts. These cars represent the absolute zenith of the most valuable collector cars in existence, with fascinating histories that illuminate the wildest age in American automotive history. Features over 600 cars. Hardcover, 224 pages, 9-7/8" x 11-1/4". L45146 49.99 ea



Automotive Manuals

Rebuild or hot-rod your engine with manuals for your small or big-block Mopar V8!

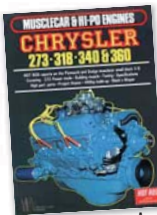

A

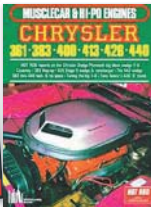

B



C

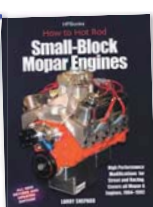

D

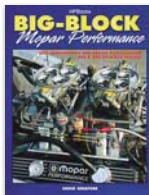

E



F



G

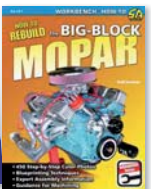

H

A - Chrysler 273-318-340 & 360

Straight from the pages of Hot Rod magazine come these tips and techniques to boost performance and build reliable horsepower. For street or strip, squeeze more horses and performance from your muscle machine. Make it move with Hot Rod and the Musclecar & Hi-Po Engine series. Softbound, 7-3/4" x 10-1/2", 100 pages.

L1050..... 19.99 ea

B - Chrysler 361-383-400-413-416-440

From the pages of Hot Rod magazine comes bolt-on, tuning tips and power secrets for the fabulous muscle engines of the 60s and 70s. Over 20 reprinted articles, each filled with great tips to hype your horsepower for street or strip. See what the muscle craze was all about, as only Hot Rod magazine can tell it. Softbound, 8" x 10-3/4", 100 pages.

L1051..... 19.99 ea

C - How to Build Big Inch Mopar Small Blocks

This book shows you how to get that big-cube power, and then it shows you how to optimize the small-block's other systems - induction, heads, valvetrain, ignition, exhaust, and more - to make the most of the extra cubic inches. Author Jim Szilagyi is a Performance Specialist for Dodge Motorsports and Mopar Performance Parts. In this book he covers building big-inches from Mopar 318/340/360 c.i. LA or Magnum 5.2/5.9-liter engines, using both factory and aftermarket parts. Black and white photos. Softbound, 8-1/2" x 11, 144 pages.

L1060..... 24.99 ea

D - How to Hot-Rod Small-Block Mopar Engines

Subtitled "High Performance Modifications for Street and Racing," this book covers all Mopar A Engines, 1964-1992. This is a completely revised, updated edition of Larry Shepard's best-selling classic, first published in 1989. Inside you'll find the latest, updated information to help modify your small-block A series Mopar for high performance, street, circle track or drag racing. Also included are updated parts information and techniques for: block, cranks, pistons and rods, cylinder heads, camshafts and valvetrain, blueprinting techniques, step-by-step engine assembly guide, oil, cooling, ignition and induction systems, engine swapping guide, engine installation and break-in tips, casting numbers and torque specs. Softbound, 8-1/2" x 11", 240 pages.

L1030..... 24.99 ea

E - Big-Block Mopar Performance

Your guide to extracting maximum horsepower and torque from the low deck "B" and high deck "RB" series Mopar engines for street and drag racing use. Techniques illustrated in this book have produced one IHRA National Championship and scores of national event wins. Includes coverage of crankshafts, rods and pistons, cylinder heads, camshafts, induction and exhaust systems; oil systems, engine assembly, race car set-ups and more. Get on the fast track to victory lane! Softbound, 8-1/2" x 11", 160 pages.

L1028..... 24.99 ea

F - How to Rebuild Big-Block Mopar Engines

This fully illustrated handbook provides detailed instructions for rebuilding and reconditioning big-block engines to factory stock specifications. Includes inspection, disassembly, reconditioning and reassembly, as well as a complete parts ID and interchange section. Softbound, 8-1/2" x 11", 176 pages.

L1027..... 24.99 ea

G - The Mopar Six-Pack Engine Handbook

How to Rebuild and Modify the 340 and 440 6-Barrel or Convert Your LA Small-Block (318-360 c.i.), Mopar Big Block (383-440 c.i.) or Magnum (5.2L-5.9L) to 6-Barrel Induction. A step-by-step guide to rebuilding, restoring and modifying the famous Mopar "Six-Pack" engines that appeared in all of Chrysler's muscle cars from 1969 through 1971, as well as the late model small-blocks and crate performance motors currently offered by Chrysler. Softbound, 8-1/4" x 5-1/4", 256 pages.

L1033..... 24.99 ea

H - How to Rebuild the Big Block Mopar

A builder's manual for Big Block 361-440 B and RB engines. Features full-color photographs with exceptionally detailed captions and clear, concise instructions to guide you through each stage of the rebuild process in exquisite detail. Install the entire rotating assembly, heads, intake, valvetrain carburetor, and all other parts with confidence. Reinstall the engine, fire it up, and get the satisfaction of having rebuilt an engine that will provide years of faithful service. Softbound, 8-1/2" x 11", 144 pages, 320 color photos.

L1094..... 24.99 ea

Automotive Manuals



I

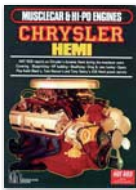

J

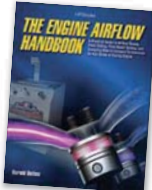

K



L

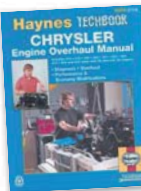

M

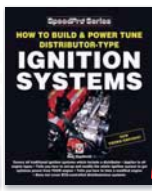

N

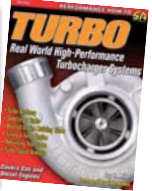

O

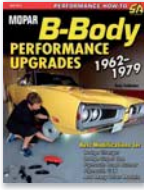

P

I - How to Rebuild & Modify Chrysler 426 Hemi Engines
Rebuild or race Chrysler's most popular engine. A step-by-step guide to rebuilding and modifying one of the most famous engines built in the U.S., including sections on racing heritage, cylinder block, ignition and lubrication systems and racing parts. Softbound, 8-1/4" x 5-1/4", 240 pages.
L1032 19.99 ea

J - Chrysler Hemi
From the pages of Hot Rod magazine comes bolt-ons, tuning tips and power secrets for the fabulous muscle engines of the 60s and 70s. Over 20 reprinted articles, each filled with great tips to hype your horsepower for street or strip. See what the muscle craze was all about, as only Hot Rod magazine can tell it. Softbound, 8" x 10-3/4", 100 pages.
L1049 19.99 ea

K - Engine Airflow Handbook
This informative and fully illustrated guide to the science of engine airflow includes basic discussion on the chemistry of airflow and fuel, testing individual components such as cylinder heads, carbs and throttle bodies, how to test an engine on a flow bench, how to analyze the numbers and how to apply to performance modifications. Softbound, 8-1/2" x 10-7/8", 192 pages.
L1054 23.99 ea

L - Step-By-Step Guide to Engine Blueprinting
Step by step guide to engine blueprinting. Includes practical methods for racing and rebuilding. How to modify pistons, cranks and connecting rods, increase performance, basic assembly tips, prepare components, compute compression, degree a camshaft and assemble cylinder heads. Softbound, 8-3/8" x 10-7/8", 160 pages.
L209 19.99 ea

M - Haynes Chrysler Engine Overhaul Manual
Covers small-block (LA series) V8 engines from 1964 through 1994, and big-block (B and RB) V8 and 3.9L V6 engines from 1958 through 1978. Includes overhaul, step-by-step procedures, diagnosis, engine removal and installation, parts interchange, performance and economy modifications, cylinder head servicing, engine identification, tools and equipment, machine shop repairs, tips on professionals, and is fully illustrated with over 300 photos. Softbound, 8-1/2" x 10-1/2", 207 pages.
L1093 29.99 ea

N. How To Build & Power Tune Distributor - Type Ignition Systems
There is a bewildering choice of expensive aftermarket ignition parts, and all claim to deliver more power. Timing and advance curves are a minefield of their own. This book cuts through the myth and hyperbole to show what really works, so that readers can build an ignition system that delivers maximum power with expert advice from an experienced race engine builder, without wasting money on parts and systems that don't deliver!
L1395 33.99 ea

O - Turbo: Real World High-Performance Turbocharger Systems
Turbochargers are incredibly appealing to performance enthusiasts because of their ability to add "free" horsepower - and lots of it - to almost any engine or vehicle. Those who want to increase the performance of their existing turbo system, or those who want to add a turbo to an existing engine, have never had so many components, vendors and resources to choose from. Whether you're running gas or diesel, 4, 6, 8, or more cylinders, this book will teach you to test, install and maintain your high-performance turbo system. You'll learn how turbochargers work, how to choose the right turbo or turbos for your engine by reading flow maps and how to tune your engine to run perfectly with your turbo system. Softbound, 8-1/2" x 11", 160 pages.
L978 24.99 ea

P - 1962-79 Mopar B-Body Performance Upgrades
This book discusses popular performance upgrades for 1962-79 Dodge & Plymouth B-Body vehicles, explains how to choose the ideal heads, carbs, intake, and carb for a complete top-end performance package. In addition, the author discusses and explains the building of a stroker engine. Stock brake upgrades and aftermarket offerings are included, including Baer and Wilwood systems. A number of weight-saving techniques that vastly improve handling and performance are revealed. This B-Body performance guide is a must-have for Mopar aficionados. Softbound, 8-1/2" x 11", 144 pages, 400 color photos.
L894 24.99 ea

Carburetor Manuals

Rebuild & Powertune Carter/ Edelbrock Carburetors

A step-by-step guide to rebuilding, modifying and tuning the Carter/Edelbrock carburetors. Carter history and model overview, an overview of carb parts and how they work, carb selection, rebuilding carbs, installation and hardware, performance and adjustments, general tuning and troubleshooting, emission, fuel economy and fuel supply, racing and special applications. Softbound, 8-1/4" x 5-1/4", 176 pages. L1034 24.99 ea

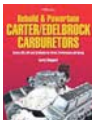

Carter/Edelbrock Carburetors

Contains photos, illustrations and diagrams, covering rebuilding, tuning and modifying Carter and Edelbrock carburetors. Also features history on the Carter company as well as the development of the AFB and the AVS since the purchase by Edelbrock. Softbound, 136 pages. 8-1/2" x 11". L433 24.99 ea

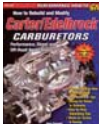

Holley Carburetors, Manifolds and Fuel Injection

High performance and stock replacement on one, two and 4 barrel Holley's, plus Holley manifolds for street and strip - how they work, basic principles, air and fuel requirements, selection and sizing, installation direction, repair and assembly, economy tuning, performance tuning and emissions. Includes sections on the operation and installation of Holley's Pro-jection fuel injection systems. Softbound, 8-1/2" x 10-7/8", 192 pages, appx. 1000 ill. L40 24.99 ea

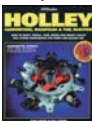

Holley Carburetor Handbook

This handbook covers the fuel inlet system, idle system, main metering system, power system, accelerator pump system, secondary system, choke system, metering blocks, repair and adjustment and more! Softbound, 6" x 9", 80 pages. L559 15.99 ea



Haynes Holley Carburetor Manual

This manual by Haynes includes detailed information on the Holley carburetor. Written for the do-it-yourselfer, it includes information the pro's could learn from. For use on 1-barrel, 2-barrel, 3-barrel and 4-barrel Holley carburetors. Information includes carburetor identification, basic troubleshooting, diagnostic checks for computer controlled carburetors, on vehicle tuning and adjustments, step by step repair and overhaul, performance and economy modifications, professional tips and tricks along with over 340 step by step photos. Softbound, 8-1/2" x 11". Approximately 200 pages. L564 29.99 ea

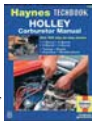

Fuel Injection Manuals

Turbocharging

A detailed, comprehensive handbook on the theory and application of turbocharging for street and high-performance use. Covers all types of domestic and import cars and trucks and RVs. Includes detailed sections on theory, types of turbocharging components, engine considerations and aftermarket applications. Softbound, 8-1/2" x 10-7/8", 192 pages. L317 24.99 ea



Turbochargers

How to select and install the correct turbo for big or small horsepower gains, turbo design, sizing and matching. Improve the performance of your engine by simply getting the right information. Covers all aspects of turbocharging and includes turbo suppliers list. Softbound, 8-1/2" x 11", 160 pages. L185 24.99 ea



High-Performance Fuel Injection Systems

In-depth discussion on the combustion basics of fuel injection as well as benefits and limitations of standalone. Covers setups and calibration, creating VE tables, creating timing maps, auxiliary output controls and start to finish calibration examples with screen shots to document the process. Softbound, 8-1/2" x 11", 128 pages. L1062 24.99 ea



Street Supercharging **New!**

Provides information regarding all aspects of supercharging, including how to install blowers, buying a kit, rebuilding manifolds, blower drives, carburetion and accessories. Softbound, 8-1/2" x 11", 128 pages. L211 24.99 ea



Painting Manuals

Paint Your Car On A Budget

This book covers everything you need to know to get a great looking coat of paint on your car and save lots of money in the process. 128 pgs. 8-1/2" x 11", 400 color photos. L917 24.99 ea



How To Paint Your Car

Reveals the techniques and technology behind automotive painting through 250 color photos, detailed captions and text. You'll get the most up-to-date information about paint chemistry, the tools of the trade and safety gear that every automotive painter must know. Step-by-step detail, how to properly prepare your car for paint, including bodywork, surface preparation and masking. Softbound, 8-1/2" x 11", 160 pgs. L3159 27.99 ea



Airbrush Painting Advanced Techniques



Airbrush Painting: Advanced Techniques

This book by famed custom painter JoAnn Bortles gives you the airbrushing tools to take your art just about anywhere. Her straightforward, clearly illustrated directions show you how to airbrush everything from backgrounds and murals to animal subjects and delicate human features on virtually any surface. Her book is an ideal guide for airbrush painters seeking to expand their skills, and for readers of Bortles' earlier book who are hungry for more. Paperback, 176 pages, 8-1/4" x 10-5/8". L35031 24.99 ea

Drivetrain Manuals



How To Rebuild & Modify Your Manual Transmission

This resource explains the principles behind the workings of all manual transmissions and helps readers understand what they need to do and know to rebuild their own transmissions. Includes how to determine what parts to replace; and where to find (& how to measure) the specifications for each particular transmission. Softbound, 8-1/4" x 10-1/2", 192 pages. L287 29.99 ea

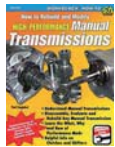

How to Build and Modify High Performance Manual Transmissions

This revised edition of How to Rebuild and Modify High-Performance Manual Transmissions breaks down the disassembly, inspection, modification/upgrade and rebuilding process into detailed yet easy-to-follow steps consistent with SA Design's other Workbook series books. The latest techniques and insider tips are revealed, so an enthusiast can quickly perform a tear-down, identify worn parts, select the best components and successfully assemble a high-performance transmission. Transmission expert and designer Paul Cangialosi shares his proven rebuilding methods, insight and 27 years of knowledge in the transmission industry. He guides you through the rebuilding process for most major high-performance transmissions, including BorgWarner T10 and super T10, GM/Muncie, Ford Toploader and Tremec T5. This new edition also contains a complete step-by-step rebuild of the Chrysler A833 transmission. Softbound, 8-1/2" x 11", 144 pages. L964 24.99 ea

Torqueflite A-727 Transmission Handbook

Provides step-by-step instructions for how to modify Chrysler's 904 Torqueflite automatic transmission for drag racing, road racing and circle racing. Topics include theory of operation, trans-brakes/valve bodies, adapters, disassembly, modifications, assembly, adjustments, installation, high horsepower application and torque converters. Softbound, 8-1/2" x 11", 240 pages. L1029 24.99 ea



High-Performance Differentials, Axles & Drivelines

Covers everything you need to know about selecting the most desirable gear ratio, rebuilding differentials and other driveline components and most importantly, matching the correct driveline components to engine power output. Learn how to set up a limited-slip differential, install high-performance axle shafts, swap out differential gears and select the best available products for the driveline. Explains rear differential basics, rear differential housings, rebuilding open rear differentials, limited-slip differentials and factory differentials. Ring and pinion gears, axle housings, axle shafts, driveshafts and U-joints are also covered. Softbound, 8-1/2" x 11", 144 pages. L1063 24.99 ea

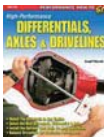

Differential Rebuilding DVD

Watch nine of the most popular differential rebuilds all in one DVD! Covered in detail is disassembly, inspection and the setup procedures for achieving a good pattern. You'll learn the different set up techniques for each unit and see the results as each shim is changed. The rebuilding and ring and pinion installation basics covered in the DVD are universal to all differentials. Approximately 120 minutes. L1610 31.99 ea

Wiring Manuals

Automotive Electrical Manual

The manual features comprehensive information which covers basic electrical fundamentals, troubleshooting and repair for both foreign and domestic vehicles. Includes: engine starting and charging systems, lights, gauges and more! Softbound, 8-1/2" x 11", 192 pages. L575 29.99 ea



Automotive Wiring & Electrical

The basics of electrical principles, including voltage, amperage, resistance and Ohm's law, are revealed in clear and concise detail, so the enthusiast understands what these mean in the construction and repair of automotive electrical circuits. Softbound, 8-1/2" x 11", 144 pages, 350 photos. L1019 24.99 ea



Automotive Wiring: A Practical Guide to Wiring Your Hot Rod or Custom Car

This book guides builders through every step from determining what components they need, to selecting wire type and gauge, methods of connection, and other considerations. The book includes numerous charts showing typical configurations and suggested installations. A troubleshooting section lends a hand in tracking down the inevitable problems that can arise. Paperback, 144 pages, 8-1/4" x 10-5/8". L39923 24.99 ea



How to Diagnose & Repair New! Automotive Electrical Systems

This book details the various tools, such as multimeters and test lights, that can be used to evaluate and troubleshoot any vehicle's electrical system. Several hands-on projects take readers on a guided tour of their vehicle's electrical system and demonstrate how to fix specific problems. Paperback, 160 pages, 8-5/16" x 10-5/8". L20990 25.99 ea



Auto Electrical Handbook

Learn about basic electrical theory, how various electrical works and drawing circuit diagrams. Includes tips on electrical test equipment and troubleshooting electrical circuits. 350 photos, drawings & diagrams. 8" x 10", softbound, 160 pages. L187 24.99 ea



Auto Electrical Performance Projects

Brilliant color photos and explanatory step-by-step captions detail the installation of the most popular, functional, and beneficial upgrades for enthusiasts of varying skill levels. Included are the installation of a complete electronic fuel injection system, upgrading an ignition system, maximizing performance of an electric fan, and the installation of electronic gauges. 8-1/2" x 11", 192 pages, 500 color photos, softbound. L3209 29.99 ea

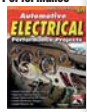

Custom Auto Wiring & Electrical

This indispensable guide to high performance and OEM automotive electrical systems covers electrical theory, wiring techniques and equipment, custom wiring harnesses for racing, hot rods and restorations, pre-made wiring harnesses, special electrical systems (navigational, audio, video), troubleshooting common electrical problems, dashboards and instrument and trailer wiring. Softbound, 8-1/4" x 5-1/4", 192 pages. L1056 24.99 ea



Custom Auto Electricity

This book will help the home based enthusiast unravel the mysteries surrounding Auto Electricals and Electronics. From a simple rewiring to installing and troubleshooting your own engine management system, it is all covered in this book. Paperback, 256 pages, 8-1/2" x 11-1/4". L98352 29.99 ea

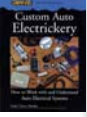

Fabrication

New!



Performance Welding Handbook

Performance Welding demonstrates the newest fabricating techniques and covers the latest in welding equipment. This complete guide helps a fabricator select the proper equipment, prepare jigs, and effectively weld 4130 steel, stainless steel, aluminum, and magnesium. It also covers plasma cutting, the technique used extensively on Monster Garage that has revolutionized metal working. 2nd edition. Paperback, 160 pages, 8.25 x 11 in.

L21720 25.99 ea



The Welder's Handbook

Excellent handbook detailing all common and not so common techniques of welding. Oxyacetylene welding and cutting, brazing and soldering. Also includes how to weld stainless-steel, aluminum, magnesium and titanium. Softbound, 8-1/2" x 11".

L144 19.99 ea

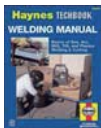

Welding Manual

This Haynes Techbook covers gas (oxyacetylene), arc, MIG and TIG welding. Soldering and flame cutting are also covered. Techniques are discussed as they relate to automotive and workshop repairs. Information on selecting equipment is also included. Softbound, 176 pages, 8-1/2" x 11".

L3088 29.99 ea

Automotive Welding: A Practical Guide

Topics include types of welding and metalworking available or commonly used, the tools required to perform welding tasks, the different types of welders available, basic welding techniques, grinding and cutting, various forms of sheetmetal work, frame repair and reinforcement, filling body holes and rust repair, tube-stee projects and more. Softbound, 8-1/2" x 11", 128 pages.

L1065 24.99 ea



Metal Fabricator's Handbook

This excellent how-to guide concentrates on race and custom cars. Covers everything from adding a hood scoop or fender flares, to building complete cars. Includes a tremendous amount of useful information. 8-1/2" x 11", 176 pages, paperback, 560 illustrations.

L42 24.99 ea



Sheet Metal Handbook

Detailed information on how to form and shape metal for competition, custom or restoration use. Chapters include hammer forming tools, terms and equipment, riveting techniques, layout, design and pattern making. Softbound, 192 pages, 8-1/2" x 11".

L243 24.99 ea



Professional Sheet Metal Fabrication

Professional Sheet Metal Fabrication is the number-one resource for sheet metal workers old and new. Dent repair and automotive patch panel fabrication are covered in detail. This is truly the most detailed enthusiast-focused sheet metal how-to book on the market. Paperback, 304 pages, 8-1/4" x 10-5/8".

L44927 39.99 ea



Automotive Bodywork and Rust Repair

Whether you want to tackle a full restoration project, or just want to save money by doing minor repairs yourself, Automotive Bodywork and Rust Repair is the book to get you through it. Softbound, 8-1/2" x 11", 160 pages.

L1086 24.99 ea



Fiberglass & Composite Materials

This informative guide covers FRP materials, fibers and fiber forms, resins, gel coats, advanced techniques, building molds and plugs, structures and materials, health and safety, tools and shop equipment. Softbound, 154 pages, b/w illustrations, 8-1/2" x 11".

L652 24.99 ea



High Performance Fasteners & Plumbing

High Performance Fasteners & Plumbing is a comprehensive guide that offers useful, practical information to help you choose the best fastener or plumbing solution for your project. Included are sections on types of fasteners, hose sizes, fittings, thread types and sizes, heat shields, brake, oil, coolant and fuel lines, routing techniques, clamping loads, stress, bolt stretch and many other tips. Softbound, 8-1/4" x 5-1/4", 176 pages.

L1053 19.99 ea



Detroit Speed's How to Build a Pro Touring Car

Learn-to-install sections cover front subframe and rear suspension assemblies as well as upgrades to wheel hubs, brakes, fuel system, driveline, cooling system, and more; also included is an LS swap. Paperback, 144 pages, 8-1/2" x 11".

L51379 26.99 ea



Race Car Chassis: Design, Structures, Materials

In this comprehensive revised and updated book, award-winning writer Forbes Aird deconstructs the race car chassis, examining the fundamentals of the design of stiff, lightweight mobile structures and the materials used to build them. Covers open-wheel and closed-wheel chassis. A valuable resource for engineers, racers and students. Softbound, 10-1/2" x 10-7/8", 128 pages.

L1055 19.99 ea



Drag Race Chassis & Suspension

Detailed information and photos on basic chassis design, how to set ride height, tubing construction, standard axle housings, choosing gear ratios, transmission choices, bolt-on traction bars, 4-link setups, ladder bars, anti-roll bars, steering, shocks, springs, brakes, wheels, tires, safety equipment and so much more! Softbound, 5-1/4" x 8 1/4", 160 pages.

L1052 24.99 ea



Chassis & Suspension Handbook

First in a series of custom techniques and tips on all areas of building a street rod. Features designing and how-to procedures on building the chassis and suspension for all types of street rods. Paperback, 8-1/2" x 11", 192 pages.

L248 24.99 ea



Automotive Welding

This book covers advanced techniques, complex joints, and working with a variety of materials. Use TIG, MIG, oxy-acetylene, and stick welding techniques to fabricate body panels, frames, weld roll cages for strength and safety, welding subframe connectors chassis rigidity, repairing an aluminum frame, creating a seat support, welding in a floor pan, and many others. Softbound, 176 pages, 8-1/2" x 11" 450 color photos.

L1399 29.99 ea



DIGITAL LITERATURE, CDS & VIDEOS

Restoration Guides

New!

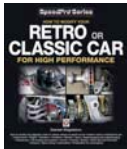

How to Modify your Retro or Classic Car for High Performance

This book explains what 'high performance' really is, analyzing each part of the classic or retro car – the engine, transmission, brakes, etc. – and showing how it can be modified and improved for greater performance, both with period correct parts (where available), and modern components such as electronic ignition. It provides specific guidance and planning advice, examining the pros and cons, and road or motorsport suitability of each modification. Paperback, 144 pages, 8" x 10".

L42895 49.99 ea

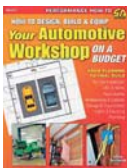

How to Design, Build & Equip Your Automotive Workshop on a Budget

This book provides the necessary information as the hobbyist considers various tools, designs, installations, and products available for their automotive workshop. Many of the ideas presented for workbenches and storage can be implemented at low or no cost. There are step-by-step instructions for the most essential and practical procedures, including basic electrical wiring sufficient to connect up bank of lights, a compressor, a welder circuit as well as a procedure for routing power from your household electrical service panel and plumbing basic shop fixtures. 8-1/2" x 11", 144 pgs, 347 color photos, softbound.

L3207 24.99 ea

How to Restore Classic Car Bodywork

A book written for the home restorer who, until now, lacked the confidence to tackle bodywork. With specially devised techniques which don't rely on workshop plant, this work spans the gap between professional and amateur. The text is readable, the photos bright and the instruction clear. A real boon for the enthusiast. Paperback, 128 pages, 8" x 10".

L44110 49.99 ea

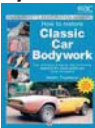

How to Keep Your Muscle Car Alive

When your muscle car was designed, the engineers never considered what it would take to make it last 30 to 40 years reliably. Luckily, this book can help turn your muscle car into a dependable driving machine. 150 color photos, 50 diagrams. Softbound, 8-1/4" x 10-5/8", 240 pgs. L11025 29.99 ea



New!



Hurst Equipped Factory Special Muscle Cars, Speed Parts & Legendary Race Cars

No other company or individual had as big an impact on so many aspects of the automotive industry as George Hurst. With an unquenchable desire to succeed, he started an automotive aftermarket parts business in his garage in Warminster, Pennsylvania. Through innovative products and marketing, Hurst Performance became the leader in high-performance shifters on the street and strip. The story of George Hurst and his companies have gone untold until now. Scores of interviews, in-depth research, and brilliant photographs make this the ultimate book on the subject. Hardbound, 160 pages, 8-1/2" x 11", 340 photos.

L1410 39.99 ea

Interior Manuals



Auto Upholstery & Interiors

A guide to performing basic upholstery and interior repairs on all kinds of automobiles written expressly for the home enthusiast. Includes helpful guides on how to replace headliners, lay carpet, repair dashboards, reupholster seat frames and more. Softbound, 8" x 10", 160 pages.

L1265 24.99 ea

Automotive Upholstery

The author teaches you how to sew like an expert, and avoid costly mistakes. Learn to recover and build seats, make headliners and carpets.

Materials are described with specific recommendations for vinyl, cloth, leather, Nimbus, panel board, etc. 230 pgs, softbound, 8-1/2" x 11", 350 b/w photos.

L378 22.99 ea

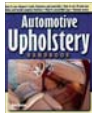

Custom Auto Interiors

More than 800 color photographs capture every detail you'll need to create your own exciting and award-winning custom interiors. Precise step-by-step instructions show you how to turn out completely professional custom interiors. This is an advanced-level book. Softbound, 192 pages, 8-1/2" x 11".

L740 26.99 ea



Automotive Custom Interiors

The book covers every aspect of design—seat and upholstery, dashboards and gauges, door panels and armrests, consoles, steering wheels, pedals, shifters, knobs and hardware, floor coverings and headliners, audio and high-tech accessories, and cargo areas and trunks. With hundreds of color photos and thorough descriptions of a wide variety of parts and accessories, this is the ultimate resource for anyone contemplating a custom interior. Paperback, 160 pages, 8-1/4" x 10-5/8".

L32887 24.99 ea



Automotive DVD



CCR04



CCR05



CCR06



Give The Gift of Knowledge, KNOWLEDGE IS HORSEPOWER

This video series' will teach you how to get a combination of carefully matched, properly tuned, horsepower pumping parts that all work together to turn your ride into a mean machine! Topics such as engine-blocks, machining, cranks, rods, pistons, compression ratios, camshafts, lifters, rocker arms, heads, porting, intake manifolds, headers, carburetion, superchargers, nitrous systems, ignition systems, tuning, gear, bearing, transmissions, torque converters and even down to which oil works the best are covered." 43006 Engine Building 34.99 ea
DCARB Perf. Constructor 29.99 ea
DSUPR Supercharges 29.99 ea
DNIT Nitrous Oxide 29.99 ea
DRTAS Rotating Assemblies 29.99 ea
DHPV Heads, Porting & Valve Trains 34.99 ea

Chop Cut Rebuild Season DVDs

Join host Dan Woods on a journey to some of Southern California's most renowned restoration and build facilities.
Season 4:
A1964 Impala and a Bricklin SV-1.
Season 5:
The first is a 1953 Chevy Pickup. The second is a 1970 Plymouth Cuda.
Season 6:
A 1969 Yenko tribute and a 1940 Mercury coupe.
CCR04 season 4 12.99 ea
CCR05 season 5 12.99 ea
CCR06 season 6 12.99 ea

Cool Ways To Protect Your Car!



Fender Gripper Fender Covers

Manufactured using a cushion-soft, non-slip material, Fender Gripper fender covers will not slide off or move around when in use. They are impervious to motor oil, coolant, brake fluid and will not harm the paint. Easily hand washable.

Note: Dimensions 22" x 34".

FG1400	Mopar Pentastar	24.99 ea
FG1401	Modern Mopar Logo	24.99 ea
FG1402	Chrysler/Plymouth	24.99 ea
FG1404	GTX	24.99 ea
FG1405	Charger	24.99 ea
FG1406	Cuda	24.99 ea
FG1407	Super Bee	24.99 ea
FG1408	Challenger	24.99 ea
FG1409	Dodge	24.99 ea
FG1410	Duster	24.99 ea
FG1411	Hemi	24.99 ea
FG1412	Plymouth	24.99 ea
FG2301	red/silver flames	24.99 ea
FG2302	blue/silver flames	24.99 ea
FG2303	yellow/silver flames	24.99 ea
FG2304	silver/blue flames	24.99 ea
FG2305	orange flames	24.99 ea
FG2307	The Money Pit	24.99 ea



BB701101

Auto Fender Bit

Hot rodders, classic car owners, and restoration craftsmen alike will appreciate the auto fender bit because it cushions and protects your paint job 360 degrees around the engine compartment. Make paint scratches a thing of the past!

BB701101	1963-76 A-Body	139.99 ea
BB701102	1965-70 B-Body	139.99 ea
BB701109	1962-64 B-Body	139.99 ea

New!

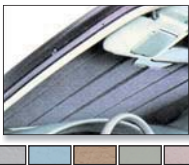

A-silver B-blue C-gold D-green E-rose

Folding Custom Windshield Heat Shield

The UVS100 Ultra-Violet Heat Shield helps reduce interior temperature and protect from damaging sun rays that come through the front windshield. One side is colored reflective fabric and the other side is finished in soft peltan felt. Both fabrics are laminated to a foam core board which acts as an insulator to help reduce heat build up. Heat Shields are easy to use. Produced using pre-sewn panels that quickly accordion-fold for handy storage. No hardware or hassles, simply fold and position across the windshield surface, then fold the sun visors down to hold the shield in place. Optional heat-shield storage bag is available in correct size for each.

Note: Specify color when ordering.

UV10128	1970-76 Duster/Demon	49.99 ea
UV10129	1967-76 Dart/Scamp/Valiant	49.99 ea
UV187	1967-76 storage bag	5.99 ea

New!



Gust Guard™ Cover Clamps

The Gust Guard™ is the easy solution for keeping your car cover in place in windy conditions! Includes 4 adjustable hem/clamps, 2 "Quick Grip" friction locks and 2-7' long white cords. These components clamp to the hem in front of the front tires and behind the rear tires. When wind gets under the car cover, the Gust Guard™ helps reduce the possibility of the cover coming loose.

CV7001		11.99 set
--------	--	-----------



Easily find your missing vehicle or family member online in real time!

Portable A-GPS Locator

With the eZoom, you can locate your children, keep tabs on teen drivers, and track down stolen items. E-mail and text message alerts tell you the unit's location, movements, and speed. The durable, waterproof eZoom device is smaller than a credit card, weighs about 2 ounces, and uses a battery that lasts up to 21 days on a single charge.

Important: A-GPS tracking and cell phone/e-mail notifications require an annual service plan with Securix, which includes live customer support and a minimum one-year commitment.

20090		99.99 ea
-------	--	----------



Phantom Key Push Button Start

The Painless Phantom Key allows the total replacement of most ignition switches. Simply remove your existing ignition switch, install the backlit stainless push button and let the Phantom Key do all the work for you. When the key fob is more than 20 feet from your vehicle, the LED backlit push button switch blinks to indicate a security device and ward off potential thieves. Extra channels for functions such as trunk popper and door lock provide the added security of not having any key tumblers for a thief to pick. Available with white, blue or red backlit 22mm switch.

Note: No further discounts apply.

55000	white backlit switch	674.99 set
55001	blue backlit switch	674.99 set
55002	red backlit switch	674.99 set

New!



RF700101

iStart™ Touch Starter System

Looking to make your classic more like late model rides? Install the iStart transponder system from Ron Francis Wiring! This system uses a security module with proximity sensors to disable the ignition switch and keep the doors locked until you come into range. Once inside, a touch-sensitive starter button lets you cycle through accessory, ignition, start/crank, and off modes just like a typical ignition switch. Skip directly to start/crank by simply holding the button!

Note: No further discounts apply. Main control box is 3-1/2" x 6". Security module is 3" x 4". iStart™ button requires 1-1/4" mounting hole.

RF700101	universal system	649.99 ea
RF700102	w/Ron Francis wiring harness	599.99 ea



TF900629

Remote Control Battery Disconnect

With this system, one click of the key fob completely shuts down your car's entire electrical system. It's accomplished by routing your main battery cable through a remote cutoff solenoid that you've stashed in a place inaccessible to a thief. Just trigger it with the key fob as you walk away. For more security, the 4-channel system not only shuts off all power from the battery, but will also control 3 other items, like closing the windows, triggering the power door locks, and interrupting electrical power to the fuel pump, all separate from the main battery cutoff. The 4-channel package can handle up to 30 amps worth of electrical equipment.

TF900629	1962-79 single channel	149.99 ea
TF900628	1962-79 4 channel	191.99 ea

Make Sure Your Vehicle Is Safe and Secure!



TF900629

1982-79 Battery Disconnect

One click of the key fob completely shuts down your car's entire electrical system by routing your main battery cable through a remote cutoff solenoid. For even more security, the 4-channel "Safe-n-Sound" system not only shuts off all power from the battery, but will also control 3 other items, like closing the windows, triggering the power door locks, and interrupting electrical power to the fuel pump, all separate from the main battery cutoff. The 4-channel package can handle up to 30 amps worth of electrical equipment.
TF900629 single channel 149.99 ea
TF900628 4 channel 191.99 ea

LED False Alarm

Deter auto theft with a "flashing red LED" that gives the appearance of a sophisticated alarm system at a fraction of the cost. In minutes the battery-operated Guardian 3000 can be installed anywhere on the dashboard.
G3000 19.99 ea

Starter-Stop Anti-Theft Device

The Starter-Stop is a low-cost theft protection device that disables the vehicles ignition. This works with virtually all 12V cars. Simply wire it into any on/off switch in your vehicle and that will become your personal kill switch. It automatically arms when the ignition is turned off. There are no batteries to wear out, no annoying siren and no transmitters to lose.
14070 19.99 ea

"Road Kill" Anti-theft Device

Stop car thieves with the "Road Kill" Anti-theft ignition shut-off kit. When activated, the engine will only run for 10 seconds. Just then, "Road Kill" shuts off the ignition and blasts the horn to get the world's attention. Each kit includes a 10 second timer, ignition relay, system on/off toggle switch, horn feed wiring and installation instructions.
T70792 99.99 ea

New!

Remote Alarm Systems

These remote alarm systems feature a one piece self contained alarm system with a 127db siren, one 4-button remote transmitter, on-board shock sensor, one-wire hook-up, built-in current sensor, panic button, car finder feature, and an antenna range up to 250 feet. Talking system features a selectable voice or chirp confirmation and 7 alarm messages.
BD800005 49.99 ea
BD2001 talking alarm 89.99 ea



Remote Keyless Entry System

Remote keyless entry system features two 4-button remote transmitters with designated lock and unlock buttons, built-in relays for door locks. Features a trunk release output, parking lamp output, starter disable output, and program buttons for special options. This system is designed for vehicles equipped with power door locks.
Note: For automatic transmissions only.
BD800006 49.99 ea



Remote Starter System

This remote starter system includes a built-in bypass, parking lamp output, and a 2-button remote. It features dedicated start and stop buttons, a 15 minute runtime, and a 400 foot range. Also works with factory keyless transmitters.
Note: For Automatic transmissions only.
BD800001 79.99 ea



Remote Starter with Keyless Entry & Trunk Release

This remote starter with keyless entry and built-in bypass includes a 4-button remote transmitter, relays for door locks, trunk release, dome lamp, and parking lamp. Features dedicated start and stop buttons, programmable runtime, programmable cold start, 400 foot range, parking lamp confirmation, and dome lamp supervision.
Note: For Automatic transmissions only.
BD800002 99.99 ea



2-Way Remote Starter w/Keyless Entry

This deluxe remote starter with keyless entry includes a 5-button LCD 2-way transmitter (up to 1/2 mile), and features an in-vehicle temperature sensing start ability, turbo timer mode, and timer controlled automatic start. The run timer is programmable for 5, 10, 20, or 30 minutes. Also features button lock, on-board relays for remote start, diesel start capability, and starter disable output. Compatible with automatic and manual transmissions.
BD800003 149.99 ea



Commando Car Alarm with Keyless Entry

Full feature car alarm system with keyless entry, a built-in relay for parking light flash, dual stage shock sensor, dome light control, and auxiliary output for trunk release.
Note: Requires existing power door lock/trunk release for keyless entry to operate.
GN520 52.99 ea



Alarm Upgrade for Keyless Entry Systems

Upgrade your car's factory or aftermarket keyless entry system to a full security system with starter-disable protection, passive or active arming, on-board flashing parking lights relay, negative output for honking horn, positive output for siren, 2 negative and 1 positive inputs, 3 programmable disarm modes, plug-in override switch, plug-in LED status indicator, dual stage shock sensor alarm pre-warning signal, 6-tone 120dB siren and a complete installation manual.
GN100 62.99 ea



GN888

Keyless Entry Alarm Systems

Two-way LCD remote car alarms with power door lock relays and built-in starter disable. Quickly unlock your doors and trunk by remote control. Built in relay for parking light flash, dual-stage dual adjust shock sensor, dome light supervision and 2 auxiliary outputs.
Note: Requires existing power door lock/trunk release for keyless entry to operate.
GN888 w/2 way pager... 104.99 ea
GN870 w/remote start... 178.99 ea



Locking Hood Pin Set

This locking hood pin set can be used in place of standard hood pins to secure your hood with two barrel locks. Kit includes two chrome plated lock sets, gaskets and escutcheons, two fully threaded lock pins with nuts and two keys. For use in conjunction with stock hood latch mechanism.
S4062 15.99 set

PEDAL JACK

The Ultimate Anti-Theft System!

By immobilizing the brake pedal, the Pedal Jack makes it impossible to drive the vehicle. Federal Vehicle safety standards require brake pedals to be unbreakable. The Pedal Jack uses this fact to its advantage in providing tamper-proof security for your vehicle. Furthermore, the Pedal Jack itself is constructed using heavy duty, heat-treated tempered steel that is saw-proof and cannot be fractured by freon gas. It has a patented high-security lock that is protected by a tempered steel plate making it drill-proof. Each lock comes with three keys that cannot be duplicated. The Pedal Jack is fully adjustable to fit perfectly on cars, vans & light trucks.
UN001A 39.99 ea



CAR CARE PRODUCTS

Inspection Approval Stamps

- Achieve complete authenticity for your vehicle by applying inspection approval stamps!
- The first and only kit designed to put inspection marks on your undercarriage and hood!
- A complete set of stamps with specially formulated paint and crayons are included to truly complete your restoration!
- Basic or deluxe kits are available depending on your restoration requirements!



It's the details that make the difference!

You may have seen the letters P.T.B. on the firewall of your vehicle. The markings have specific meanings. We've offered a brief explanation to the most commonly asked questions concerning the replacement of these markings. The key between a good restoration and a great restoration is how much detail is put into it. Enter your restored vehicle in the show of your choice and maintain complete originality by obtaining the correct inspection markings. The judges will be impressed!

Questions and Answers

- Q. What does P.T.B. stand for?
 A. P.T.B. means P = Paint, T = Trim, B = Body.
 Q. Do they go in any certain order?
 A. No. They can be mixed up in any way you like. PTB, TBP, BTP, TPB, etc. The most common way is PTB.
 Q. Where do they go?
 A. PTB can be on either side of the firewall but the drivers side is the most common. They have also been seen on the side of the cowl behind the fender but it would be useless to put them there since they can't be seen.
 Q. What color should they be?
 A. They can be orange, light green, or a mixture of both. For example P=orange, T=light green, B=orange, or anyway you like. If your PTB is still intact before your restoration, do your new PTB's in the same colors. Not all vehicles included PTB's but when restoring yours we suggest you put them on.



Factory Inspection Marking Kits

Includes the correct P.T.B. stamps with specially formulated paint to give your vehicle the final inspection marks that the factory put on. Also included are the yellow and white crayons for marking your firewall with the factory inspection marks. A must for any true restoration.

- CC12 basic kit 2 paint colors, 2 brushes 72.99 kit
 CC13 deluxe kit 7 paint colors, 7 brushes 129.99 kit

Body Markers/Paints



Chassis Inspection Mark Paints

Restore the many colored factory marks found on your suspension, engine and driveline components. These marks are found on most cars, and were used for inspection, parts picking codes and alignment marks. These inspection paints are color matched to original. In many cases they're supplied with technical bulletins to help you apply them in the proper locations. Supplied in 2 oz. brush top bottles.

PM03101	dark blue	10.99 ea
PM03101L	medium blue	10.99 ea
PM03102	bright yellow #1	10.99 ea
PM03103	white	10.99 ea
PM03104	original #1	10.99 ea
PM03105	green #1	10.99 ea
PM03106	dark green #2	10.99 ea
PM03107	red	10.99 ea
PM03108	spindle orange	10.99 ea
PM03109	pitman arm blue	10.99 ea
PM03110	lavender	10.99 ea
PM03105	orange #2	10.99 ea
PM03112	green #3	10.99 ea
PM03113	orange #3	10.99 ea
PM03114	yellow #2	10.99 ea
PM03115	light blue	10.99 ea
PM03116	dark blue	10.99 ea
PM03118	crossmember orange	10.99 ea
PM03120	purple	10.99 ea
PM03121	dark green	10.99 ea
PM03122	bright green	10.99 ea
PM03123	gray	10.99 ea
PM03124	blue	10.99 ea
PM03125	pink	10.99 ea



Firewall and Frame Marking Crayons

These are the correct "grease pencil style" crayons used for marking the factory inspection marks on your firewall, subframe and other various sheet metal areas. Included are a yellow and a white marking crayon.

K0084 5.99 pr



Frame Engine And Body Markers

Auto makers use these permanent markers to write codes and numbers on frames, engines and body components. Engine suffix codes were often written on the back of the cylinder heads. Job numbers were written on the firewall, frame, engine and other components to assure the correct car was being built according to the build sheet. These permanent paint markers will help you exactly duplicate the factory original marks.

PM0301	white	10.99 ea
PM0302	green	10.99 ea
PM0303	orange	10.99 ea
PM0304	red	10.99 ea
PM0305	yellow	10.99 ea

Car Care Products

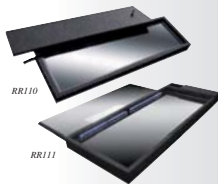

Show Mirrors

These Self-contained mirrors provides a large viewing area to display the underside of your show car. A 48" x 20" acrylic flex mirror mounted in a lightweight, frame provides a rugged, stylish package that is easy to use and transport. Available with or without lights.

Note: Shipped oversize.

RR110	unlit	304.99 ea
RR111	lighted	404.99 ea

New!



Car Show Display Stand

Next car show, let this stand show off your vehicle for you! This display stand features an elegant shape, double wall construction, and a tough polyurethane finish. Designed for standard 8.5" x 11.00" page format with 10.5" x 23.5" maximum display area. Fill with ballast for extra stability. Includes stainless steel hardware.

AS100339	61.99 ea
----------	----------

Rust Prevention Magic

RPM is a revolutionary breakthrough for auto restorers who desire to keep their metal looking brand new and factory original. This product is a blend of the finest water-proofing polymers known to the automotive industry. It republishes and protects against all forms of oxidation on bare metal components.

RP1001	8 oz. jar	34.99 ea
--------	-----------	----------

Joe Gibbs Driven™ Degreaser

Safely remove tire rubber, grease and oil from your car. Will not harm paint. Just spray on and wipe off. Works great for cleaning up shop equipment and tools as well. Professional strength formula foams away dirt, grease, and oil from all automotive parts and surfaces.

JG1310	18 oz. can	4.99 ea
JG1311	case of 12	59.99 cs

Mothers® California Gold Sealer And Glaze

Enjoy the ultimate brilliance of a show car shine on all paint types and colors including clear coats, blacks, reds and candies. Fills and hides scratches, swirl marks and spider webbing. Formulated to achieve spectacular, professional results by hand or with a buffer. Will not streak, smear or fingerprint and may be used over existing wax.

M08100	16 fl. oz.	7.99 ea
--------	------------	---------

California Gold Natural Formula Liquid Wax

This natural formula wax contains carnauba wax and just enough modern chemistry to let you easily apply it, remove the light haze and enjoy the most spectacular shine you will ever experience. For a truly brilliant shine, accept no substitute.

M05750	16 fl. oz.	11.99 ea
--------	------------	----------

Mothers® Mag & Aluminum Polish

Mothers' secret formula is world renowned for providing the easiest, brightest shine for aluminum wheels, manifolds, valve covers, brass trim, all alloy parts and accessories. Tough enough to tackle the most neglected metals, yet gentle enough to use every day.

M05100	5 oz.	5.99 ea
M05101	10 oz. economy size	8.99 ea

Leaves Surfaces Clean And Streak Free

Mothers® Chrome & Glass Cleaner/Protector

Ideal for cleaning and protecting windows, mirrors, bumpers, wheels and chrome trim. Leaves surfaces clean and streak free. Unique protecting agents resist smears and fingerprints.

M05208	12 fl. oz.	5.99 ea
--------	------------	---------

Mothers® Upholstery and Carpet Cleaner

Upholstery and Carpet Cleaner is a must for removing stubborn dirt and stains from velour, vinyl, cloth, carpets and sheepskin covers. Safe and effective on all automotive fabrics, yet works great for home use too. This special formula is designed to get out some of the toughest dirt you'll find. Even works great on grease, gum and stains caused from mud.

M05422	24 fl. oz.	7.99 ea
--------	------------	---------



LeatherTech Foaming Wash

LeatherTech Foaming Wash is an air-infused rich lather cleansing solution that penetrates and cleans stains from even the most neglected finished leather and vinyl surfaces. Glycerin-enriched micro-emulsion provides moisture balance while encapsulating agents lift away dirt and debris, leaving your leather clean and ready for conditioning.

M06410	8 fl. oz.	6.99 ea
--------	-----------	---------



Moisture Infusion Gel Cream

LeatherTech Moisture Infusion goes beyond conventional conditioning with advanced hydration to nourish and protect leather surfaces in one simple step. Premium conditioners replenish natural oils lost to heat and sunlight with a moisture lock to prevent fading, drying and cracking. Keep your leather soft and supple for years to come!

M06310	8 fl. oz.	11.99 ea
--------	-----------	----------

Mothers® Back To Black

Perfect for all vinyl, rubber, plastic, flat finishes, yet surfaces need not be black to achieve superior results. Works incredibly well on both smooth and textured surfaces, bumpers, protective and decorative moldings, lowers, air vents, window trim and wiper arms. After applying, surfaces look new again and will be protected against further oxidation or deterioration caused by harsh elements.

M06108	8 fl. oz.	6.99 ea
--------	-----------	---------



Mothers® Back to Black Tire Renew

Back-to-Black Tire Renew is formulated to dissolve and lift stubborn dirt, grease, road grime, brake dust and old dressings from any tire, even whitewalls. Tough on dirt but gentle tires, Back-to-Black leaves a naturally clean surface. Just spray on and wipe off!

M09324	24 fl. oz.	5.99 ea
--------	------------	---------



OER® - The New Standard of Excellence in Car Care!

Professional Products for the Enthusiast!

Professional grade car care detailing supplies are no longer just for professionals. OER® is pleased to offer our complete line of car care products for the auto detailing professional and/or classic car enthusiast. Now you can purchase our exclusive "Secret Formula" car care products in consumer friendly 16 oz. bottles, and you too can achieve the amazing results that only a detailer using professional grade products can achieve. If you detail your car often, take advantage of our bulk packaging and purchase your favorite products by the gallon! If you are tired of paying for expensive bottles with colorful labels and achieving mediocre results, then do your car's delicate finish a favor and order our complete car care system today. OER® offers the highest quality car care formulas at any price, without the hype of expensive advertising and high dollar packaging. No fancy bottles or labels to pay for, our product speaks for itself!



OER®
 Exclusive Formulas
 Not Available In Stores!

OER Secret Formula Wash & Wax Products

OER® Super Foam Maxi Suds Car Wash

This high sudsing, biodegradable liquid is concentrated 200:1 for economy. Mix one cap full with 4-5 gallons of water for a daily paint shampoo. Washes away dirt, grease and road grime, and rinses easily. Its pH balanced formula will not harm previously applied wax or sealant. A concentrated liquid car wash that offers economy without sacrificing high performance cleaning ability.



Whether you use hard or soft water does not matter; Super Foam produces thick, rich suds that lift away dirt and oily road film. The unique Secret Formula offers unmatched lubricity to assure that particles glide gently across surface and are safely rinsed off. Formulated with OER® Super Foam Maxi Suds - high suds foaming action. Engineered to simply be the best wash & gloss at any price.

K89612 16 oz. bottle.....	9.99 ea
K89613 1 gallon.....	24.99 ea

OER® "Secret Formula" DA Polish

This bodysop safe, 100% wax and silicone free polish will prepare any paint for the perfect sealant. Available in your choice of 2 grades to rapidly remove light scratches, swirls, key marks, fingernail scratches, and other imperfections. Each grade starts out as a polish then breaks down to a final step product that produces an exceptional shine. Use the Pro-Polish as a final product or a superior foundation for wax, sealant or glaze. To start out with a slightly more aggressive polish, step up to the medium grit product Scratch & Swirl B-Gone. For best results use with a DA or rotary polisher.



Pro-Polish - Final Step - Light Cut 3000 grit
 K89607 light to final 12 oz..... 39.99 ea
 K89608 light to final 32 oz..... 39.99 ea
Scratch & Swirl B-Gone - Med Cut 1500-1700 grit
 K89609 medium to final 12 oz..... 14.99 ea
 K89610 medium to final 32 oz..... 39.99 ea

OER® "Secret Formula" Clay Bar System

Clay pulls out all the contaminants you cannot see, but that you can definitely feel, like industrial fallout, rail dust, and brake dust. Though these contaminants are not visible, you can tell they are there because the paint will feel rough or gritty. These contaminants may cause patches of paint to appear dull, even after waxing. As these contaminants oxidize, they create rust spots within the paint. Once this happens, the oxidation is considerably harder to remove and will most likely take a good bit of paint with it. Clay bar will remove these contaminants and leave the surface silky smooth with a mirror-like smooth finish. One premium professional duty bar is enough to do 8-10 vehicles. Our clay will not break or deteriorate into small particles like inferior low quality clay bars. Super elastic to remove harmful particles quickly and effectively. Acts as a magnet to foreign particles, literally pulling the paint-fouling grime away from the surface of the paint. Clay lubricant is essential to the performance and safety of clay. It provides the necessary slick surface for clay to glide on. Using low quality clay lubes or cheap detail sprays will deteriorate your bar and lead to poor clay bar performance. Also beware of soapy water as a clay lube, detergent or surfactant based soaps will cause the clay to deteriorate. OER® Stick It Clay Lubricant is available in a 16 oz. bottle or pro-sized gallon.



OER® Stick It Clay Lubricant		
K89444 16 oz. bottle.....	9.99 ea	
K89445 1 gallon.....	32.99 ea	
OER® Secret Formula Clay Block		
K89477 blue block, light duty for regular everyday use.....	14.99 ea	
K89478 gray block, medium duty for moderate oxidation.....	14.99 ea	
K89449 black block, heavy duty for heavy oxidation.....	14.99 ea	

OER® "Secret Formula" Acrylic Shine Glaze

Glaze is a polish without any cleaning properties. Glazes are used primarily to improve the shine brilliance and clarity of paint. Primarily used by body shops for finishing jobs or by detail shops to bring out the high brilliance of paints on a vehicle, glazes are also commonly used on show vehicles to achieve a "high-luster or wet-look". It was developed for the darker finishes, using a slightly moister formulation to enhance the difficult to wax paint finishes. The application process is forgiving, smooth and dust free. Your moldings WILL NOT turn white. Glazes do not replace polishing. If a surface has minor swirls and imperfections, to achieve the best superior results, the surface should be polished with our OER® Secret Formula Pro-Polish first.

K89620 32 oz. bottle.....	39.99 ea
K89621 1 gallon.....	69.99 ea



OER® DA Paint Sealant + 3X Carnauba

Just one coat of this sealant is all you need to protect your auto's finish for 6 to 8 months. OER® DA Paint Sealant's 3X Carnauba creates an anti-static, heat resistant protective seal against corrosive elements such as ultraviolet rays, salt water, acid rain and industrial pollutants. Can be applied in multiple layers to deepen the shine and level of protection without compromising your paint or clear coat. Coats your vehicle in a protective seal delivering a glossy, rich, liquid shimmer that leaps off the paint surface. Anti-static formula discourages the settling of new dust. Bring out the depth of the paint color while the shine enhancers leave a glass-like mirror finish.

K89601 12 oz. bottle.....	17.99 ea
K89602 1 gallon.....	29.99 ea



CAR CARE PRODUCTS

Get The OER® Advantage... It's Almost Unfair!

OER® "Secret Formula" Waterless Wash

We care for the environment, and if you share the same feeling, try our OER® Secret Formula Waterless Wash... a unique product which can help you conserve water while keeping your car sparkling clean.

However, just because our product doesn't call for the use of water, by no means is it any less effective. In fact, because there is no water, it is much easier on the finish and other bodywork in general. It cleans, shines and protects all paints, clear coats, rubber, vinyl and plastic surfaces. It even softens and breaks down light surface contamination while it captures and reduces dirt particles, lifting them off the surface of your vehicle. For all its cleaning power, it won't strip or remove wax or sealants and delivers superior results in the sun or in the shade. It's inexpensive, provides outstanding results, and is so easy to use... It's almost unfair!

K89605 16 oz. bottle..... 9.99 ea
K89606 1 gallon..... 39.99 ea

OER® "Secret Formula" Stick-It Spray Wax

OER® Stick-It Spray Wax is a quick, easy-to-use spray wax. Spray on and wipe off! Our special high-lubricity secret formula actually encapsulates dust particles and enhances a deep luster without using water. This innovative product removes surface dust, fingerprints and smudges from showroom vehicles while leaving a clean glossy finish. Softens and breaks down light surface contamination while it captures and reduces dirt particles and lifts them off the surface of your vehicle. Will not strip or remove wax or sealants. Good product to upkeep shine on a show quality finish or as a final product to go over the vehicle after a good wax or sealant application. It's inexpensive, provides outstanding results, and is so easy to use... It's almost unfair!

K89444 16 oz. bottle..... 9.99 ea
K89445 1 gallon..... 32.99 ea

OER® "Secret Formula" Headlight Restorer

OER® Secret Formula Headlight Restorer Professional Polish for plastic headlight lenses is not only affordable, but unlike most of the other headlight restorer products available in the market, is a professional formula that is remarkably easy to use. However, we do recommend that you apply it with the aid of a machine for best results. Over a period of time, the headlight lenses are bound to become yellowed and hazy. In such a situation, you have two options, spend hundreds of dollars for replacement, or try restoration. The latter is what our product is meant for. Save money! That's right, you no longer have to replace foggy headlights. In addition, you do not have to settle for exorbitantly-priced headlight restorer products available elsewhere. We offer better alternative for less. Have a safer ride. When restored, your headlights will deliver better luminance, yielding up to 30% more road visibility.

K89628 12 oz. bottle..... 17.99 ea



K89440

K89828 - sold separately

OER® Premium Carnauba Hard Paste Wax

This product is a favorite among professionals in the industry as well as automotive connoisseurs who insist on the finest quality. Made from 100% pure Brazilian Carnauba Wax, this hard paste wax leaves any finish with an exceptionally long-lasting, lustrous, clear shine. Apply by hand with a damp cloth. For pre-cleaned surfaces only. As hard as a brick, yet easy to apply and remove. For use on any color paint. Bonds with clean paint, waxes and sealants to offer a deeper richer shine and longer lasting protection. One coat is truly all you need, however layered it as many times as you want to achieve desired results. Long lasting 2-3 month protection. Formulated for successful use even in the sun! Works like a sun block to protect your paint and deliver an unparalleled show-car shine. The 5" round microfibrer applicator pads make it easy to apply waxes or rubbing compounds without scratching paint or clear coat. Simply rinse and re-use. Microfibrer applicators are highly absorbent, strong yet gentle and the fabric is machine washable.

K89440 7 oz. can..... 19.99 ea
K89828 5" microfibrer applicator..... 3.99 pr



K89623

K89828 - sold separately

OER® Premium Carnauba Pre-Softened Wax

OER® Secret Formula Pre-Softened Carnauba Paste Wax is in a class all its own. A pre-softened paste wax with no cleaners, it leaves a deep, brilliant long-lasting shine. It protects and beads up with a glass like gloss that lasts up to 6 months. It works beautifully on all colors, even on blacks, reds, and burgundies, filling in swirl marks. It's also super easy on and off: just wipe on in a circular motion, and take off with a microfibrer immediately. No need to wait for it to dry! Leaves no white haze at all- there is no white residue to clean out of the cracks, and no need to be careful around the exterior trim- it won't leave white marks! There's no trade-off here: the easiest application in the world, and the best results! Great grape smell. For the enthusiast who demands the highest and wettest level of shine. OER® Secret Formula Pre-Softened Carnauba Paste Wax is a premium blend of genuine carnauba wax and natural oils that makes paint "drip off of your vehicle" with a high gloss shine and shimmer that is sure to impress even the toughest critics. The 5" round microfibrer applicator pads make it easy to apply waxes or rubbing compounds without scratching paint or clear coat. Simply rinse and re-use. Microfibrer applicators are highly absorbent, strong yet gentle and the fabric is machine washable.

K89622 15 oz. can..... 39.99 ea
K89623 20 oz. can..... 49.99 ea
K89828 5" microfibrer applicator..... 3.99 pr

OER® Liquid Carnauba Butter

Wet Wax Creme

This is a brand new technology that consists of a special blend of polymers, resins, and natural carnauba. OER® Secret Formula Liquid Carnauba Butter Wet Wax Creme gives your car shining like it was just washed! Contains no cleaners or abrasives, and will not stain plastic or rubber. Suitable for easy application and removal in the sun or shade, hot or cool temperatures. Shows best on dark finishes, but works great on all colors. Shines and polishes with no cleaners or abrasives. Long lasting protection that brings out the deep shine and luster of all colors. Slippery non-stick protection and gloss. You'll swear the car is wet. Available in your choice of 12 oz. bottle or buy the professional-sized gallon jug and save!

K89603 16 oz. bottle..... 14.99 ea
K89604 1 gallon..... 57.99 ea

OER® Liquid Carnauba Cherry Wet Wax Creme

OER® Secret Formula Cherry Wet Wax Creme! Liquid Carnauba will leave your car shining like it's still in the wet! This liquid Carnauba shines and polishes with no cleaners or abrasives and will not stain plastic or rubber! Suitable for easy application whether in the sun or shade, and is easy to use in hot or cold climates. This fast and easy one-step cream wax cleans, polishes and protects in one operation. Gently removes fine scratches, buffer marks and light oxidation. Natural oils restore gloss and enhance depth. Imported waxes and copolymers offer long term, high gloss protection. Safe for all paint finishes with a pleasant cherry scent. For hand or machine use. Offering not only long-lasting protection, it also brings out the deep shine and luster of all colors. Slippery non-stick protection and gloss. You'll swear your car's still wet! Available in your choice of 16 oz. bottle or buy the professional-sized gallon jug and save!

K89624 16 oz. bottle..... 14.99 ea
K89625 1 gallon..... 57.99 ea

OER® Proseal 109 Carnauba Paint Sealant

OER® Secret Formula ProSeal 109 Carnauba Paint Sealant is a proprietary blend of fluorocarbon polymer resins that creates a slippery, slick barrier that accelerates water runoff and protects auto finishes from rain, acid rain, salt, dust, and water spotting. Easy application by hand! OER® Secret Formula ProSeal 109 provides high gloss protection in minutes! Cleans, polishes, and protects new and classic cars, trucks, vans, and even boats. Contains 100% pure carnauba wax; the easiest natural wax available. Quickly cleans, seals and shines all paint finishes, vinyl, plastic, rubber and chrome trim. Easily removes tar, tree sap, road film, paint oxidation and water stains. OER® Secret Formula ProSeal 109 contains UV light absorbers to reduce fading, oxidation, and cracking of paints. Non-abrasive and safe for all automotive finishes.

K89626 12 oz. bottle..... 24.99 ea

OER® - The New Standard of Excellence in Car Care!



OER® Top Secret Top Care Formula

OER® Top Secret is a complete system for the care of vinyl or canvas tops. It consists of a heavy duty cleaner that safely removes the toughest soils and stains with an exclusive formula that will not harm automotive finishes. Included in the vinyl kit is our vinyl UV protectant and applicator to shield your vinyl top against damaging UV rays. A 100% dry to the touch formula that will last weeks, not days. The canvas formula includes the top cleaner and our exclusive canvas UV protectant that repels water and stains.

OER® Top Secret Kit - Vinyl Formula
K89456 cleaner, protectant & applicator..... 22.99 kit

OER® Top Secret Kit - Canvas Formula
K89457 cleaner & protectant..... 22.99 kit

OER® Top Secret Components
K89458 16 oz. bottle top cleaner..... 9.99 ea
K89468 16 oz. bottle vinyl protectant..... 10.99 ea
K89489 10 oz. aerosol canvas protectant..... 14.99 ea
K89460 applicator..... 3.99 ea



OER® Interior/Exterior Multi-Purpose Fabric & Upholstery Cleaner

OER® Secret Formula Interior Exterior Multi Purpose Fabric Cleaner is a solvent based cleaner that works quickly as a spot cleaner for all color-fast fabrics. Will not stain or leave a ring around area cleaned. This product removes oil, grease, tar, grime, paint, adhesives, chewing gum, waxes and greasy food spots. Effective on canvas and vinyl tops, upholstery, rugs, vinyl interior components, and leather. Cleans spots and stains on carpet, upholstery, fabric, vinyl and canvas tops, and just about any other interior or exterior surface made of cloth, fabric, canvas, or vinyl. Fast and easy to use. OER® Secret Formula Interior Exterior Multi Purpose Fabric Cleaner was specifically developed to tackle even the most stubborn stains. The K89465 is an Industrial Strength version of our Interior Exterior Multi Purpose Fabric Cleaner that should be diluted 100:1 minimum for use as a spray on interior and exterior fabrics. For a ready-to-use formula in spray bottle, use item # K89458.

K89458 16 oz. bottle (ready-to-spray)..... 9.99 ea
K89465 1 gallon (industrial strength)..... 29.99 ea



OER® Ammonia Free Glass Cleaner

OER® Secret Formula Glass Cleaner is a streak-free, tint safe window cleaner and quite possibly the best window cleaning liquid ever made. Streak free formula for glass or plastic that sprays like water. No foam and no harsh smell. Just wipe and watch dirt, grease, water spots, smudges, fingerprints, forehead grease and just about anything else disappear. No streaks ever! Formulated with non-ionic surfactants, specialized molecules that are 100% non-toxic and all surface safe, no-reactivity, 100% ammonia free and safe to use on tinted windows, clear plastic instrument panel lenses, and headlamp and taillamp lenses! One gallon mixes with up to 3 gallons of distilled water to make more product. It's easy to save money! Available in your choice of 16 oz. spray bottle or professional size gallon jug.

K89466 16 oz. bottle..... 8.99 ea
K89467 1 gallon..... 19.99 ea



New!



Full Function Detailing Power Sprayer

Detail your classic car or truck like a pro! Featuring heavy duty construction, this full-function power atomizer and pump sprayer operates with no noise, no electricity and no waste. Features pre-marked measures in order to mix products correctly. Can be used with any and all OER® Secret Formula sprayable products including window cleaners and degreasers. Simply fill with product, tighten the head, pump it 3 times and start detailing. One full bottle will easily detail 15-20 full size vehicles with zero waste. This sprayer system will save you 40-50 minutes when compared to traditional detailing spray bottles.

K89826 atomizer/pump..... 29.99 ea
K89828 replacement nozzle..... 4.99 ea



OER® Secret Formula Professional Dressings

Finally you can get the level of shine you desire with a professional grade formula that is not greasy, will not drip, is dry to the touch and lasts far longer than any product sold in stores. Additionally, our products soak in to nourish and protect the surface while repelling dust and dirt. Your choice of matte finish for an original appearance or super shine for a high gloss look.

OER® Super Shine High Gloss Protectant

The only 100% super shine, dry to the touch dressing that works as well on vinyl, leather, rubber, and tires as it does on hard plastics, plastic bumpers and trim. A multi-surface shield for your vehicle's interior. Dual action premium dressing leaves surfaces dry to the touch and shining better than new, while protecting the surface against dirt and dust. Maintains a 100% dry, never greasy or oily, fresh texture on vinyl, leather, plastic, rubber, tires and more! Water based emulsion repels dirt and dust while blocking out harmful UV rays. Surfaces treated with OER® Secret Agent Shine look shiny longer and require less cleaning. Extra thick, pure emulsion will not separate or sling and is easy to apply with towel or sponge. Industry leading sealant that aids in protecting seats, steering wheels, door panels, and dashboards against the elements.

K89468 16 oz. bottle..... 10.99 ea
K89469 1 gallon..... 39.99 ea



OER® Natural Shine Matte Finish Protectant

OER® Natural Shine Matte Finish Protectant is a water-based natural look dressing. It leaves surfaces supple and protected against damaging UV radiation. Like new matte finish lasts weeks and nicely complements a clean interior. Cleans, protects and beautifies in one easy step. Gently wipes away light traces of dirt while you apply. Patented UV absorber penetrates and acts as a protective barrier against harmful rays that cause premature aging, cracking, fading and peeling. Engineered to work like a lotion to soak into new vinyl or dry vinyl to aid in prolonging and strengthening the surface. Perfect for use on dashboards, vinyl tops, door panels, consoles, tires, trim, bumpers, vinyl seats, moldings and more. Available in your choice of 16 oz. bottle or professional size gallon jug.

K89480 16 oz. bottle..... 10.99 ea
K89481 1 gallon..... 39.99 ea



Get The OER® Advantage... It's Almost Unfair!



K89493



K89494



K89825

K89492



K89496

K89495

Professional Detailing Supplies

Professional detailing supplies for the automotive enthusiast. Now you can buy your favorite products in bulk 1-gallon sizes and refill your own professional grade heavy duty spray bottles! Sprayers are made of Viton® for superior chemical resistance. The adjustable nozzle sprays from a fine mist to a jet stream. Long lasting durability only available from a professional grade sprayer.

- HD Bottles with Chemical Resistant Sprayers**
 K89493 package of three 16 oz. bottles..... 13.99 pk
 K89494 package of three 32 oz. bottles..... 16.99 pk
"Ketchup" 12 oz. Bottle
 K89825 12 oz. "ketchup" bottle..... 2.99 ea
"Ketchup" Top for Squeeze Bottle (38/400 thread)
 K89492 package of three..... 4.99 pk
Hand Pump for One Gallon Bottle
 K89496 professional pump..... 7.99 ea
Chemical Resistant Industrial Trigger Sprayer
 K89495 for 16 oz. or 32 oz. bottle..... 2.99 ea



OER® Extreme Shine Premium Metal Polish & Sealant

OER® Extreme Shine Metal Polish & Sealant cuts through layers of dulling oxides to restore a wet-mirror like finish that outshines chrome. This outstanding polish makes chrome, copper, brass, aluminum, stainless steel and other metalwork gleam and look their absolute best. Spreads on with ease, buffs off with little effort. Great for oxidized metals and even light rust. Can be easily applied in the shade or sun. Leaves virtually no smear, dust or powder. The most innovative metal polish ever. A 3-step product in one, this diminishing metal polish cuts fast, cleans like no other, shines like a mirror and protects like a sealant. Utilizing friction and heat OER® Extreme Shine Metal Polish cleans, restores, revives and polishes. Friction generates heat that allows the product to break down into a micro-fine polish that leaves the surface shining like a mirror. During the final phase, it breaks down to release the durable protective sealant that bonds to metal surfaces reducing corrosion and prolonging shine. Use by hand with a polisher or with your polish ball & drill.

K89483 16 oz. bottle..... 17.99 ea

OER® "Secret Formula" Wheel & Tire Care



OER® Secret Formula Wheel & Tire Care

Over the years, OER® has become the name that you have come to trust for quality restoration products. We are dedicated to bringing our valued customers the absolute best products our industry has to offer. When it comes to car care, our "Secret Formula" products are no exception! We know you have a lot invested in your classic car, so we have formulated products that not only perform at a level unmatched by any other brand, but a formula that keeps your investment in mind. Our formulas are engineered not only to keep your pride and joy looking good, but also to protect your vehicle's delicate surfaces from the elements without the use of harsh damaging chemicals.

OER® Acid Free Wheel & Tire Cleaner

Spray on and rinse off! Easily removes deposits of brake dust, grease, and road grime from wheels. Safe for clear coated, painted, and polished finishes. This strong non-acid formula is fortified with a citrus cleaning agent. This is an industrial strength 1:1 concentrate. Dilute with water as needed. Long time accumulations of brake dust may need light agitation with a soft brush. Unlike many alternative products, OER® Acid Free Wheel Cleaner dissolves grime and brake dust without damaging your chrome and alloy wheels. Non-acidic, spray-on wipe-off formula with no scrubbing necessary and no harsh scent.



K89614 32 oz. bottle..... 17.99 ea
 K89615 1 gallon..... 34.99 ea



Secret Weapon Polish Ball

The Secret Weapon Polish Ball bends and compresses enabling it to fit into tight spaces and make the cleaning and polishing of difficult, hard to reach areas like wheels, rims and other metal work much easier. Can be attached to any hand held drill or drill-like device for fast and superior cleaning and polishing. Great for cleaning and buffing small items like mirrors, headlight lenses and trim parts. Space-age Dura-foam and fiber-soft materials make it the most durable tool of its kind. Comes in your choice of two sizes, a 2.5-inch, 3.5-inch, or 4.5-inch ball. Ideal for use with your favorite wax, polish, wheel product or compound.

K89490 2.5 inch polish ball..... 26.99 ea
 K89491 3.5 inch polish ball..... 28.99 ea
 K89498 4.5 inch polish ball..... 29.99 ea

OER® TNT Extended Life Tire & Trim Dressing

This unique formula quickly penetrates rubber trim and seals to hydrate and provide lasting protection. TNT Extended Life gel by OER® finally delivers on that promise. Simply wipe on using a pad and TNT gel restores the look of faded tires, trim, bumpers, seals and weatherstrip.

What's more, OER® TNT gel lasts for many months, not days. Our exclusive non-streak, non-run and non-drip formula works to repel water and detergents and helps keep tire walls hydrated and supple as well as looking brand spanking new. Prepare your trim for a product unlike any other. A true premium trim restorer and protectant, that will not drip, dry out or destroy surfaces. Provides unmatched durability, ease of application and a superior "new look" shine that lasts through numerous washes. Non-greasy, non-tacky and simply amazing.



K89616 32 oz. bottle..... 22.99 ea
 K89617 1 gallon..... 49.99 ea

High Performance Car Care Products



Grit Guard insert
keeps the wash water
clean & scratch-free!

Grit Guard Wash System

This unique wash bucket provides a convenient way to store or transport all of your car cleaning supplies while doubling as an extremely effective finish-protecting wash tool. The Grit Guard insert sits in the bottom of the pail to extract particles and contaminants from mitts and brushes. Gravity causes sand and dirt to settle below the guard so the wash water stays clean and scratch-free.

Basic Wash System

The basic wash system includes a black pail with a yellow sealing lid and a Grit Guard insert.

K89740	3.5 gal.	28.99 ea
K89741	5 gal.	32.99 ea

Grit Guard Deluxe Wash Bucket Sets

This superb washing system features a Grit Guard insert, a heavy-duty bucket, a seat cushion and a dolly that turns the washing system into a rolling stool, so you can sit down and detail your car comfortably. Five heavy-duty smooth-rolling casters roll over cracks without tipping. Two locking casters hold your washing system in place while working on inclines. The convenient spin-on lid creates a perfectly sealed storage compartment for all of your favorite cleaning supplies. Supports up to 250 pounds.

Deluxe Washing System

K89742	3.5 gal black pail w/yellow top	64.99 set
K89743	5 gal yellow pail w/black top	67.99 set

Individual Components

K89744	Grit Guard insert	9.99 ea
K89745	5 caster dolly	34.99 ea
K89746	cushion/kneeling pad	9.99 ea
K89750	Gamma seal lid	11.99 ea
K89751	5 gal yellow pail w/black insert	26.99 ea

Dual Wash Bucket System

This system includes two dollies, two Grit Guard inserts, two sealing lids, a dual-bucket connector plate and a seat cushion. The idea behind a two bucket wash is simple; two buckets means double the protection from swirl marks and scratches. With a designated rinse bucket, all the dirt and grime from your vehicle stays out of the clean, soap-filled wash bucket and off your prized possessions.

K89748	5 gal dual wash	134.99 set
--------	-----------------	------------

Torpedo Billet Polisher

The Torpedo Billet Polisher is great for getting into tight areas on wheels, engine components and more.

Attaches to most all drills and effortlessly buffs out scuffs, oxidation, tarnish, brake dust and corrosion on metals even fiberglass. This is a strong and perfectly balanced brush, densely filled with soft white cotton yarn. Unique material holds polishing and buffing compound better than cloth and has great pliability, which enables for a directional mark free finish.

K89860		19.99 ea
--------	--	----------

New!



Buffer Bit

The Buffer Bit Bullet and Mini are made from a unique, high-density foam, which will not tear or break apart. Designed for longevity and durability, yet soft enough for polishing or finishing. Works great on intricate metal trim, fiberglass, plastics, wheels and even engine components. Each Buffer Bit Mini includes 1 bit and 2 pads, 1 cone and 1 circle. Available in orange for polishing and in blue for finishing.

Buffer Bit Bullet

K89845	orange	polishing	29.99 ea
K89846	blue	finishing	29.99 ea

Buffer Bit Mini

K89847	orange	polishing	22.99 ea
K89848	blue	finishing	22.99 ea



62441
(large duster)

62443
(mini duster)

Pick Up Layers of Dust with One Sweep!

An easy way of keeping your vehicle clean and free of dust, looking like it was just washed. If's specially-treated cotton fibers lift dust off the surface without scratching the paint, even delicate lacquers. The more you use it, the better it works! Regular use can significantly reduce the frequency of washings.

62441	large duster	16.99 ea
62443	mini duster	8.99 ea
62444	buy both dusters & save!	23.99 set



K89811

K89812

K89813

TW9X

Microfiber Wash/Polish Mitts and Pads

Chenille microfiber wash mitts and pads are gentle on your paint and clean great. Chenille is a deep-pile, velvety cord made of durable, woolen microfiber and are plush, absorbent, lint-free and 100% scratch free. The "scrubber side" is made from a microfiber mesh great for removing bird or bug mess from non-painted surfaces. The cotton wash mitts superior water absorption and retention qualities are combined using the right amount of durable fiber. Microfiber polish mitt puts waxing in your hands easier. This polish mitt will beautifully and protect your paint or metal surfaces when waxing.

Chenille Microfiber

K89811	premium Chenille wash mitt	7.99 ea
K89812	wash mitt with scrubber side	6.99 ea
K89813	wash pad with scrubber side	6.99 ea

Cotton Microfiber

TW9X	wash mitt	4.99 ea
------	-----------	---------

Monster Microfiber Towels

Fattest, thickest and most absorbent microfiber towel. They are durable and silk bonded for long lasting use with streak and scratch free results every time.

K89805	16" x 16"	single	4.99 ea
K89806	16" x 16"	3 pack	13.49 set
K89807	17" x 24"	single	6.99 ea
K89808	17" x 24"	3 pack	18.99 set



K89808

Elite Microfiber Towels

Extra plush, super absorbent, lint-free and 100% scratch-free.

The long fiber side works great in quick detail and waterless car wash applications. The short fiber side is great for buffing and cleaning windows.

K89819	16" x 16"	single	3.99 ea
K89820	16" x 16"	3 pack	10.99 set
K89824	25" x 36"	extra thick	12.99 ea



K89819

Waffle Weave Towels

Super absorbent, ultra plush, waffle weave towels. Its unique magnetic charge attracts lint and dirt, trapping it in the weave so it will not scratch the surface.

K89810	26" x 32"	each	9.99 ea
K89821	26" x 32"	3 pack	34.99 set



K89821

Premium White Cotton Towels

These thick, super absorbent, pre-shrunk combed cotton white towels are manufactured from 100% Supima cotton.

K89809	25" x 16"	dozen	24.99 set
--------	-----------	-------	-----------



Extra Large Chamois

Our synthetic chamois is great for detailers or those with large vehicles. This synthetic, machine washable chamois glides over surfaces and soaks up water without leaving any water residue.

K89814	natural	31" x 23"	24.99 ea
--------	---------	-----------	----------



Microfiber Bug Remover Cloth

The microfiber bug remover cloth makes it safe and easy to remove that unwanted bug splatter from your vehicle without scratching your paint.

M121	16" x 16"	4.99 ea
------	-----------	---------



Microfiber Applicator Pads

Professional grade microfiber applicator pads are the ideal choice for applying wax, sealants, glazes, dressing or your favorite conditioners.

K89816		5.99 pr
--------	--	---------



Microfiber Applicator Pads

These 5" round microfiber applicator pads make it easy to apply waxes or rubbing compounds. Deep penetrating fibers are lint and scratch free. Won't scratch paint or clear coat. They absorb 8 times their own weight in water and hold dust, dirt, grease and spills. Simply rinse and re-use. Machine washable. Apply dressing and begin detailing!

K89828		3.99 pr
--------	--	---------



New!

High Performance Car Care Products

13 Piece Set Includes:

- Tire Brush
- Wheel Spoke Brush
- Interior Brush
- Carpet Brush
- Ultra-Soft Body Brush
- Soft Grill/Trim Brush
- Heavy-Duty Brush
- Wheel Well Brush
- 10" Handles
- 20" Handles



Soft rubber edging prevents paint dings

Contoured rubber handle for comfort and grip

Deluxe Professional Detailing Brushes

These deluxe professional detailing brushes are the finest on the market. They feature ergonomically, soft padded handles for hours of use with less fatigue. A soft rubber edging surrounding the edges on the bristle portion of the brush helps to prevent accidental scratches or dings to your vehicle. Sets are available to meet your needs.

Specialty Small Brush Set

BS201	7 piece	29.99 set
Body Wash Brush Set		
BS202	3 piece 10" handles	26.99 set
BS203	3 piece 20" handles	33.99 set
Buy the Complete Set and Save!		
BS204	13 piece complete brush set	88.99 set

New!



Attaches to any standard drill.

Power Scrub Drill Brush

Use drill brush with any drill to clean carpet, fabrics, upholstery, seats, wheels and much more. The yellow brush has soft bristles and can be used to clean carpet, upholstery, fabrics, door panels, wheels and more. The red brush is heavy duty with very stiff bristles and is meant for intense scrubbing of hard surfaces. Use it to remove heavy grease, grime or loose paint.

K8987	yellow-light duty	14.99 ea
K89818	red-heavy duty	14.99 ea

Power Automotive Waxer

This lightweight, rechargeable buffer/waxer features a built-in liquid wax pump and reservoir for effortless waxing and polishing.

Runs for one hour on a single charge.

Includes three 10" machine washable buffing pads,		
(2) waxing pads and (1) fine polishing pad.		
800669	waxer/buffer	55.99 ea



New!



10 Piece Set Includes:

- Tire Brush
- Wheel Spoke Brush
- Interior Brush
- Heavy-Duty Brush
- Soft Wash Brush
- Gentle Grill/Trim Brush
- 8" Handles
- 18" Handles

Professional Detailing Brushes

These are professional type brushes that will make detailing your classic a little easier. They feature heavy-duty, soft or gentle bristles, depending on the cleaning job on hand. Handles are made of quality hard plastic to withstand hours of use. Several kits are available to meet your needs.

Specialty Brush Set

K89852	4 piece	22.99 set
Body Wash Brush Set		
K89850	3 piece 8" handles	18.99 set
K89851	3 piece 18" handles	26.99 set
Buy the Complete Set and Save!		
K89853	10 piece complete brush set	68.99 set



Specialty Brushes

Keep your vehicle shining with these high-quality specialty brushes. Each brush is specially designed for the application indicated.

TW117	tire brush	3.99 ea
TW114	wheel and bumper brush	4.99 ea
K89497	soft foam wheel/spoke brush	9.99 ea
K89840	standard head, soft bristles	14.99 ea
K89841	tri-head, soft bristles	15.99 ea
K89842	wrap-around head, soft bristles	16.99 ea
K89843	wrap-around head, strong bristles	16.99 ea
K89844	telescoping comfort grip handle	15.99 ea

New!

CLASSIC AUTHORIZED



The Jerry Blade

The Jerry Blade sweeps away water droplets faster than a cloth or a sponge. Soft silicone material flexes to follow contours without scratching. Also ideal for use around the home on windows or glass surfaces. K89829 blue handle 9.99 ea



Quick & Effortless Drying

The Ezi Dry squeegee is a revolutionary tool designed for quick & effortless drying of your car. The twin blade, flexible-head contours to any surface. Comfortable non-slip grip makes it easy to dry large areas. C800504 9.99 ea



Auto Wash Stick

The Auto Wash Stick is the fastest & easiest way to wash your vehicle. Cleaning solution is pulled into stick by submersing in bucket & then pulling back on handle. Dispense solution as needed by pushing forward as you wash. C800477 19.99 ea



Industrial Grade Fire Hose Nozzle

Control your spray pattern and pressure with this industrial grade fire hose nozzle. This nozzle works just like those used by fire departments. Manufactured of heavy-duty, anodized aluminum and features a protective rubber bumper. K89815 12.99 ea

Protect Your Wheels From Harmful Overspray

The RIM PRO™ wheel-protector is foldable and comes with a handy pouch for easy storage and accessibility. Hand washable. Available in 13", 14", 16" & 18".



RM105, buy one for each of your vehicles. 9.99 ea

Accessories For The Ultimate Classic Car Garage!



MV101

Powerful Dual-Purpose Vacuum/Blowers

The Vac 'N' Blo® is an industrial-type 200MPH indoor/outdoor Vacuum Cleaner/Blower combination together in one portable lightweight unit. The original model features a powerful 4.0 peak horsepower motor, and comes complete with two 20' extension wands, Powerizer™ Air Maximizer, permanent cloth bag, and 2 year manufacturer's limited motor warranty. The miniature Vac 'N' Blo® Jr. models include 1/2 horsepower motor, power unit, one 20' extension wand, and five extra reusable/disposable paper bags. Choose from 110-volt (household current) or 12-volt (cigarette lighter) power source for Jr. models. All models feature rugged steel construction, baked enamel finish, flexible hose, Pick-All nozzle, Magic Air™ inflator adapter, dust brush, crevice tool, and shoulder strap.

Vac 'N' Blo Original

MV101 vacuum/power blower 219.99 ea

Vac 'N' Blo Jr. 110 Volt

MV102A household use 84.99 ea

Vac 'N' Blo Jr. 12 Volt

MV102B attaches to car lighter 89.99 ea

Adjustable seat provides the support, leaving your feet free to control your movement



Floating, attached kneepads eliminate direct pressure on knees, circulation problems

Removable tray holds tools, small

Aluminum frame is elevated on 2" casters to eliminate pressure on toes, ankles and knees

Speed And Comfort For A Demanding Job!

This seat provides support while taking pressure off knees, ankles and toes. The caster wheels allow you to move freely, and the attached floating kneepads allow your knees to rest. Attached to the tool is a 7" x 15" removable tray which is great for holding tools, fasteners, small parts, etc. Weighing only 8 lbs., the tool is manufactured from 1/8" thick industrial strength aluminum. The comfortable webbing seat is covered with a soft leather-like cover and adjusts vertically 11.5" to 15.5" in height. It also adjusts 3" horizontally and tilts. Backed by a 1 year manufacturer's limited warranty. X99115 197.99 ea

The Kneepool

Manufactured from brittle dip anodized aircraft aluminum, The Kneepool features premium extruded aluminum wheel carriers with an increased tool carrying capacity. Includes soft yet durable pads for hours of use.



14660 The Kneepool 174.99 ea

Garage Laser Park

Laser shines onto your vehicle to precisely guide you to the correct spot. Helps prevent damage to your car and your garage. Easy installation. Simply attach to your garage ceiling with included hook-&-loop tape or screws. No wiring necessary. Automatically activates when your vehicle enters the garage. Powered by 110 Volt AC adapter (included). Park your car in the garage in the same spot every time!



37310 1-Laser Park 29.99 ea
37312 2-Laser Park 39.99 ea

New!



T243



T245

Stainless Steel Magnetic Parts Trays

Put an end to lost parts with these magnetic trays! Powerful rubber-coated magnets keep your parts where they belong and prevent the tray from sliding on metal surfaces. Manufactured from durable stainless steel with a partial lid to keep parts in their place.

T243 circular single parts dish 9.99 ea
T245 rectangular double parts tray 17.99 ea

New!



AR200100



MF980071



MF980072

Wall Mount Rolling Rack

shown with dollies stored - not included

Auto Dollies

Move your project around the garage with ease! The Auto Dollies are manufactured from 1/4" steel plate, featuring zinc plated ball-bearing castors and 1-3/4" wide rollers. Each standard dolly supports up to 1500 pounds, and for larger vehicles, the heavy duty model supports up to 2500 pounds. Storage is made simple with the wall-mount Dolly Dock, or the convenient Rolling Rack! Auto Dollies measure 16" long and are available in 8", 12", and 16" widths. Sold in pairs.

Standard

AS200100 8" wide x 16" long 71.99 pr
AS200101 12" wide x 16" long 74.99 pr
AS200102 16" wide x 16" long 79.99 pr

Heavy Duty

AS200103 8" wide x 16" long 89.99 pr
AS200104 12" wide x 16" long 99.99 pr
AS200105 16" wide x 16" long 109.99 pr

Accessories

MF980071 dolly dock 39.99 ea
MF980072 dolly rolling rack 84.99 ea

New!



K89747

K89749

Buffing Pad Wash Bucket & Detailing Cart

Buffing/Polishing Pad Washer

When you hand wash pads, the backing pad gets wet, oversaturating the foam. The universal pad washer keeps the backing pads dry and extends the life of your pads. No more throwing away perfectly good pads because the backing pad has torn off. Your buffing pads, buffing bonnets, polishing tools and accessories clean up so well you'll think they're new! Condition, clean, and dry all in one system. The universal pad washer extracts contaminants trapped deep inside your buffing pads. No cross contamination worries when switching buffing compounds. O-ring seal lid provides water-tight portability. Wash and dry in under 30 seconds! K89747 134.99 ea

Detailing Cart

The universal detail cart organizes all of your most commonly used detailing products and makes them mobile! Store your compounds, polishes, sealants, waxes, cleaners, brushes, pads, towels and polishers. It also features a built in cutout for holding your wash bucket or pad washer. Overall Dimensions: 24" wide x 18" long x 40" high. Shelf clearance is 12".

Note: Cart only. Buckets and products shown are sold separately.

K89749 189.99 ea



car completely covered



Touchless Car Cover

Using an old-fashioned car cover after washing your car can promote the growth of mold and bacteria under the cover in those unreachable nooks and crannies resulting in a car that smells like mildew. No dust, no trapped moisture, and no chance for mold to grow. Just drive in and out to cover your car! Zippered sides allow access with the cover in place. There are no metal parts to corrode. Easy to set up and use with universal front and rear skirts. Fit sedans, wagons and coupes 196" or shorter. W34002 289.99 ea

Accessories For The Ultimate Classic Car Garage!



Protection For Your Garage Floor

The Clean Park Mat catches all of the fluids and debris that falls off your vehicle while it is parked. Made of heavy duty 20-mil vinyl with raised plastic edges, it can prevent gallons of liquid from spreading onto the garage floor.

ACP115	7-1/2' x 16'	184.99 ea
ACP116	7-1/2' x 18'	179.99 ea
ACP117	7-1/2' x 20'	189.99 ea



Wall Guard



Hanging Door Guard

Two Ways To Prevent Costly Paint Chips

The Wall Guard attaches to your garage wall providing cushioned protection for both your car door and your wall. Comes complete with hardware needed to attach to drywall, studs, brick or concrete. Pre-drilled holes are 16 and 24" apart for fastening to stud. Measures 25" x 6-1/2". Our Hanging Door Guard is ideal for two car households. This rubber-like pad hangs from the rafters or drywall ceiling of your garage providing a protective barrier between both vehicles. You in effect protect two vehicles with one product. Hardware for hanging the device is included. Measures 25" x 6-1/2"

ACP102	Wall Guard	11.99 ea
ACP103	Hanging Door Guard	19.99 ea

Park Perfectly Every Time

The Park Smart Mat helps guide you into your garage space letting you know exactly when to stop. Perfect for getting your classic or collectible car into the correct position in a crowded garage.

As you feel yourself driving over the first bump, the second bump tells you that you have driven far enough forward. Measures 27-1/2" x 12" x 1-1/2". Comes with a manufacturers limited lifetime warranty. Buy one for each of your cars.

ACP101	Park Smart Mat	19.99 ea
--------	----------------	----------



Wheel Checks

Wheel Checks are ideal for use with all Race Ramp products, providing additional safety in the working environment. Made from solid rubber composite with an extra-grip bottom, they each weigh 3 pounds. Set of 4.

Note: For increased safety, use Wheel Checks with all Race Ramp products.

RR109	6" L x 4" H x 5" W	59.99 set
-------	--------------------	-----------



Wheel Cribs

Wheel Cribs are a safe, lightweight alternative to jack stands. They cradle the tire 10" off the ground, providing unobstructed access underneath the car. Each crib supports 1,500 pounds (3,000 pounds per set) and weighs only 5 pounds. Wheel Cribs also can be used for car display.

Note: For increased safety, use Wheel Checks with all Race Ramp products.

RR108	15" L x 10" H x 12" W	104.99 pr
-------	-----------------------	-----------



Race Ramps

Race Ramps are ideal for vehicles with tires up to 10" wide. With an incline of only 10.75 degrees, they lift your car up 8" or 10" and hold up to 3,000 pounds per set while weighing only 10 pounds per ramp. Will not slide across a garage floor, dig into an asphalt driveway, or scratch or otherwise damage a cement or painted floor. They can be used on grass, dirt, or almost any other flat surface, and they will never rust. Race Ramps come complete with straps for easy carrying and storage.

Note: For increased safety, use Wheel Checks with all Race Ramp products. *Shipped oversize.

56" x 12" Race Ramp with 8" Lift	209.99 pr	
RR100	one piece design	
RR101	two piece design	234.99 pr
67" x 14" Race Ramp with 10" Lift		
RR102*	one piece design	299.99 pr
RR103*	two piece design	344.99 pr



Flatstoppers

This product helps to keep your tires from flat spotting during long periods of storage. Once the tires are set in the FlatStoppers, more of the bottom portion of the tire will be fully supported, thus dispersing the weight of the car more evenly onto the tire to prevent any flattening. FlatStoppers will not conduct heat or cold to your tires despite changing floor temperatures.

RR104	4 piece set	259.99 set
-------	-------------	------------



Wall Mounted Wheel/Tire Hanger

Free up space by getting wheels and tires off the floor! Each heavy duty powder coated hanger is approx. 21" long and mounts at a slight angle so wheels won't slide off.

Note: Each hanger will hold 2 wheels with tire inside.

M998070	wheel/tire hanger	39.99 ea
---------	-------------------	----------



KG007

KG003

Seasonal Tire Totes

Take the hassle out of changing your seasonal tires with this handy pair of Seasonal Tire Totes. Heavy duty shell with ease to carry handles protect you and your clothes from brake and tire residue. Tires stay neatly covered and stacked until the next season. Wheel Felts slide into the Tire Tote and clip into place to protect wheels from nicks and scratches.

KG003	Tire Totes	one size fits all	19.99 pr
KG007	Wheel Felts	20" diameter	12.99 pr

Store Your Tires in the Tire Garage!

The Tire Garage allows you to keep tires outside and free-up needed space in your garage or storage area. This rugged weatherproof shell is made from the same material used to make boat covers and awnings.

KG005	one size fits all	39.99 ea
-------	-------------------	----------



Protection From Moisture During Storage

Sta-Dri pouches significantly reduce humidity and moisture inside of your vehicle safely & conveniently.

Pouches can be regenerated up to 3 times. Use 1-2 pouches per vehicle. Depending on humidity level, one pouch can last up to a year of continuous storage, though it is recommended that you check every month & regenerate as necessary. Non-toxic & non-corrosive, remains dry to the touch even when fully saturated.

BF1001	2 lb. pouch	11.99 ea
BF1002	2 lb. pouches	21.99 pr
BF1003	four 2 lb. pouches	35.99 set



OER® Rust Removal & Prevention

Remove Rust

OER® Dissolve Rust

OER® Chemical Restoration Dissolve Rust returns rusted surfaces to bare metal without harming the integrity of the metal. The viscous formula is reusable and will not harm plastic, rubber, seal, soft metals, or non-oxide coatings

such as paint and chrome. OER® Chemical Restoration Dissolve Rust works like an acid, but is safe for you and the environment. OER® Chemical Restoration Dissolve Rust is ideal for removing rust from any part or surface that can remain damp with the product until the rust is gone!

K86110 quart..... 19.99 ea



dissolve

- **OER® Dissolve Rust** removes rust leaving a bare metal surface.



Treat Rust

OER® Etch Metal

OER® Chemical Restoration Etch Metal inhibits rust and promotes paint adhesion for bare metal surfaces. This specially formulated liquid gently etches the metal, then leaves a zinc coating that helps chemically bind paint to the surface. OER® Chemical Restoration Etch Metal is non-toxic, non-flammable and reusable. Ideal for application on bare metal parts after sandblasting or using OER® Chemical Restoration Dissolve Rust.

K86114 pint..... 19.99 ea



etch

- **OER® Etch Metal** removes light surface rust and leaves a coating that bonds paint to the metal surface.



OER® Convert Rust

OER® Chemical Restoration Convert Rust instantly neutralizes rust and converts the rusted surface, leaving a protective dark polymer coating. The inert coating provides an excellent primer base that seals out moisture to prevent future rust and corrosion. Protected surface can then be top coated with most paints. OER® Chemical Restoration Convert Rust can be applied with a brush, trigger bottle or a spray gun. Brush - A common household paint brush or foam applicator. Spray Gun - HVLP or conventional spray gun using a 1.0-1.4 nozzle at low pressure. Available in quart bottles.

K86112 quart..... 29.99 ea



convert

- **OER® Convert Rust** turns rust into a black, paintable polymeric coating that's ready for primer or top coat.



Inhibit Rust

OER® Inhibit Rust

OER® Chemical Restoration Inhibit Rust is durable clear coating that protects any metal substrate from rust and corrosion for up to 7 years.

It provides a superior bond to treated and non treated surfaces such as undercarriage, suspension components, wheel wells, fenders, and more. Easy to use and safe for use on metal, stainless, copper, aluminum, and fiberglass. Withstands temperatures up to 190°F with two or more coats.

Clear formula eliminates the need to mask off areas and it cleans up easily with solvent cleaner. OER® Chemical Restoration Inhibit Rust also protects and provides added UV resistance to painted to powder coated surfaces. OER® Chemical Restoration Inhibit Rust protects against weathering, oxidation, pitting, salt spray, fuel, tar, road debris, and modest abrasion.

K86123 16 oz. aerosol..... 19.99 ea



glossy clear coat

- **OER® Inhibit Rust** bonds to any metal substrate completely sealing the area to starve rust and oxidation, to prevent pitting, weathering, abrasion, & protect against salt spray, fuel, tar, and road debris.



Your Choice of Gloss Black, Satin Black or Gloss Clear!

■ OER® Corrosion Barrier 77

bonds to bare or rusty metal. Can be brushed or sprayed on to permanently stop corrosion. Isolates metal from moisture and oxygen keeping rust in a suspended state and creates a finish that is unaffected by road salt, battery acid and other corrosives.



gloss black



satin black



gloss clear



apply over bare metal



apply over rusty metal



apply over bare metal



OER® Corrosion Barrier 77

After removing or treating rust on floors, subframes, or other under-car components, OER® Chemical Restoration Corrosion Barrier 77 is a single-component, high-solids, rust stopping paint specially formulated to bond to bare or rusted metal surfaces. The coating forms a rock hard finish that's flexible, non-porous and will not crack, chip, flake or peel. No hardeners or activators are needed. OER® Chemical Restoration Corrosion Barrier 77 is perfect for floors, subframes and other under-car panels. It is completely unaffected by salt, gasoline, oils, battery acids, hydraulic fluids, solvents, chemicals, or corrosives. Available in gloss or satin finish.

K86118 1 quart, gloss..... 59.99 ea
K86118 1 quart, satin..... 59.99 ea
K86132 1 quart, gloss clear..... 49.99 ea

Spray-On Insulation

New!



Buy the Complete Set & Save!

BEFORE APPLICATION



AFTER APPLICATION



Shared Benefits:

- Easy spray-on application
- Continuous protective moisture barrier
- Fast clean up with soap and water
- Environmentally friendly solution
- Applicable to interior or exterior of vehicle
- Non-toxic and class A fire-rated
- Both are paintable
- Coverage is approx. 50 ft² gallons

Sound Control Benefits:

- Provides non-combustible thermal insulation
- Able to withstand temperatures up to 500°F
- Interior temperature reduced by 30°F
- Offers a protective, seamless membrane

Ceramic Insulation Benefits:

- Protects surface from moisture & rust
- Dampens annoying rattles, vibrations & road noise
- Impressive damping to weight ratio
- Coating can withstand temperatures up to 300°F

Lizard Skin® Sound Control and Ceramic Insulation

Get the comfort of premium grade insulation without the extra weight! These environmentally safe formulas from LizardSkin® can be used as a one-part coating or as a two stage system for a cooler, quieter driving experience. The Sound Control formula dampens unwanted engine and road noise, while the Ceramic Insulation formula cools your vehicle up to 30°F or more creating a more comfortable ride. Designed for floors, roofs, firewalls, fenders, transmission tunnels, door panels, trunks, and more, all at a combined cured weight of 52 lbs. for four gallons. Insulating a vehicle has never been this easy, thanks to a custom-designed application gun made specifically to handle the thick density of the coatings with ease. Order the individual components or buy a complete kit and save!

Important: For two-stage applications, Sound Control coating should be used as the base. Four gallons of each coating are required to encapsulate a typical interior and trunk area of 1 vehicle, and 1 gallon of Sound Control when applied as undercoating.

Sound Control			
152984	1-gallon pail	84.99	ea
152985	2-gallon pail	159.99	ea
Ceramic Insulation			
152986	1-gallon pail	89.99	ea
152987	2-gallon pail	169.99	ea
SuperPro Gun			
152988	SuperPro gun and stir paddle	85.99	ea
Mini Sets			
R8091	4-gallons of Sound Control with SuperPro gun	359.99	kit
R8092	4-gallons of Ceramic Insulation with SuperPro gun	379.99	kit
Complete Set			
R8093	4-gallons of each formula with a SuperPro gun	669.99	kit



PX2006 Master Tech Kit Includes:

- 1 ea. 30g powder-white
- 1 ea. 30g powder-black
- 1 ea. 30g powder-clear
- 1 ea. 50ml liquid
- 2 ea. molding bar
- 2 ea. applicator bottle
- 4 ea. applicator needle
- 3 ea. powder dish
- 1 ea. pipet
- 1 ea. fiber reinforcement cloth
- 1 ea. plastic reusable case
- 1 ea. instruction CD

PX1901 Shop Kit Includes:

- 1 ea. 250g powder - white
- 1 ea. 300ml liquid
- 3 ea. molding bar
- 1 ea. applicator bottle
- 2 ea. applicator needle
- 1 ea. applicator dish
- 1 ea. pipet
- 1 ea. Video CD

PLASTEX Master/Shop Plastic Repair Sets

Plastex plastic repair sets are just what you need to repair those small plastic parts that can still be used on the vehicle instead of replacement. Each set includes all the necessary components required to repair plastic parts.

PX2006	master tech set-30g ea. powder, 50ml liquid with case	68.99	ea
PX1901	shop set-white 250g powder, 300ml liquid	102.99	ea
PX1902	shop set-black 250g powder, 300ml liquid	102.99	ea
PX1903	shop set-clear-250g powder, 300ml liquid	102.99	ea



PLASTEX Plastic Repair Sets

Plastex plastic repair sets are just what you need to repair those small plastic parts that can still be used on the vehicle instead of replacement. Each set includes all the necessary components required to repair plastic parts. Available in white, black or clear. All sets include molding bar, bottle, needle and pipet.

PX2001	standard set, white-30g powder, 50ml liquid	29.99	ea
PX2002	standard set, black-30g powder, 50ml liquid	29.99	ea
PX2003	standard set, clear-30g powder, 50ml liquid	26.99	ea
PX1801	small set white-5g powder, 10ml liquid	11.99	ea
PX1802	small set black-5g powder, 10ml liquid	13.99	ea
PX1803	small set clear-5g powder, 10ml liquid	13.99	ea
PX1805	mini master set 5g ea. wht, blk & clear powder, 10ml liquid	14.99	ea

PLASTEX Plastic Repair Set Refills

Individual refills for all the components of the repair kits to replenish your stock.			
PX2101	30g powder	white	10.99 ea
PX2102	30g powder	black	11.99 ea
PX2103	30g powder	clear	11.99 ea
PX2110	50ml liquid		9.99 ea
PX2115	molding bars	set of 3	9.99 set
PX2120	applicator needles	set of 4	3.99 set
PX2121	applicator bottles	set of 2	3.99 set
PX2122	mixing cups	set of 2	2.99 set
PX2123	pipet		.99 ea
PX2124	fiberglass cloth	approx. 1 sq. ft.	2.49 ea
PX1002	instruction CD		2.49 ea

OER® Aerosol Coatings



All new quart cans
now available!

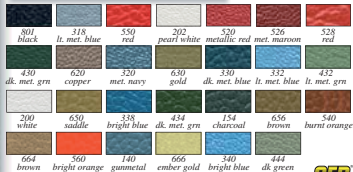

OER® Premium Quality Aerosol Interior Paint

OER's revolutionary formula provides 40% more coverage than standard dyes and lacquers and actually penetrates and bonds at the molecular level to the surface to permanently seal in the color. Dries to the touch in 45 seconds and forms a complete bond in just 10 minutes. UV stable and color fast, it will not crack, flake or peel. For use on vinyl, leather, ABS plastic, polycarbonate, polypropylene, polyurethane, acrylic, lexan, fiberglass and recycled plastics. When only the best will do, use OER® Premium Quality Interior Paint. Available in your choice of convenient 12 oz. aerosol cans or quart cans for bigger jobs where a spray gun is required.

Note: Shipped within the continental U.S. only. Shipped ground only.

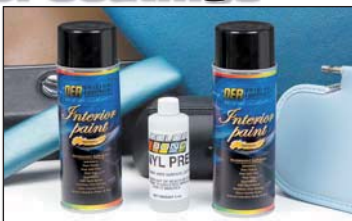

OER® Interior Surface Preparation Formulas

Before spray painting, make sure to properly prepare the surface for topcoat. We offer a variety of surface preparation products to ready reproduction dash pads, headrests, door panels, padded pillar moldings, plastic parts, metal components and other parts for the application of the topcoat.

Note: Shipped within the continental U.S. only. Shipped ground only.

- PP1009 OER® colorbond prep cleaner, 4 oz. bottle..... 7.99 ea
- PP215 OER® paint adhesion promoter, 12 oz. aerosol..... 15.99 ea
- PP618 OER® metal and plastic primer, 12 oz. aerosol..... 16.99 ea



OER® Carpet Restoration Formula

Formulated to enhance and restore faded, worn or stained surfaces, our OER® Carpet Dyes molecularly bond to carpeting for a finished result that will not wear off. A great product for restoring carpet or for spraying carpeted trim panels on consoles, door panels and other carpeted trim. An easy way to renew worn or stained carpeted floor mats as well. Available in a convenient user friendly aerosol spray that dries in minutes. Available in a variety of colors to match or accent your interior. Order each color in 12 oz. individual aerosol cans or buy the case of six cans and save!

Note: Shipped within the continental U.S. only. Shipped ground only.

12 oz. Aerosol Cans

- PP900 black..... 16.99 ea
- PP901 taupe..... 16.99 ea
- PP902 gray..... 16.99 ea
- PP903 dark gray..... 16.99 ea
- PP904 crimson red..... 16.99 ea

Case of Six 12 oz. Aerosol Cans

- PP905 black..... 89.99 cs
- PP907 gray..... 89.99 cs
- PP908 dark gray..... 89.99 cs
- PP909 crimson red..... 89.99 cs

Retail Pricing

		Aerosol \$16.99 ea	Quart \$59.99 ea
1960-76	Mopar black	PP801	PQ801
1964-67	Mopar light metallic blue	PP318	PQ318
1964-65, 1970	Mopar red	PP550	PQ550
1962-69	Mopar pearl white	PP202	PQ202
1964-68	Mopar metallic red	PP520	PQ520
1965, 1968	Mopar metallic maroon	PP526	PQ526
1966, 1968-69	Mopar red	PP528	PQ528
1966-68	Mopar dark metallic green	PP430	PQ430
1967	Mopar copper	PP620	PQ620
1965-68	Mopar metallic navy	PP320	PQ320
1967-69	Mopar gold	PP630	PQ630
1968-71	Mopar dark metallic blue	PP330	PQ330
1968-72	Mopar light metallic blue	PP332	PQ332
1968-72	Mopar light metallic green	PP432	PQ432
1969	Mopar white	PP200	PQ200
1969	Mopar saddle	PP650	PQ650
1969-70	Mopar bright blue	PP338	PQ338
1969-71	Mopar dark metallic green	PP434	PQ434
1969-72	Mopar charcoal	PP154	PQ154
1970	Mopar brown	PP656	PQ656
1970	Mopar burnt orange	PP540	PQ540
1970-71	Mopar brown	PP664	PQ664
1971	Mopar bright orange	PP560	PQ560
1971	Mopar gunmetal	PP140	PQ140
1971-72	Mopar ember gold	PP666	PQ666
1971-73	Mopar bright blue	PP340	PQ340
1972-73	Mopar dark green	PP444	PQ444

OER® Aerosol Coatings

- Correct Original Colors**
- High Hiding Formulation**
- Simple-to-Use Spray Can**
- Manufactured In The USA!**
- Cost Effective/No Waste**
- Resistant to 400° F**

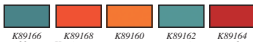

OER® Classic Blend Engine Paint

OER® Classic Blend Engine Paint offers maximum coverage and adhesion to air cleaners, engine blocks, heads, intake manifolds, valve covers, water pumps, oil pans, transmission cases and more. This specially formulated engine paint is unaffected by rust, gasoline, oil, grease, salt and extreme humidity and is also resistant to temperatures of up to 400° F. This special paint blend offers excellent hiding ability and delivers spray-gun quality results without the mess or hassle of mixing paint or cleaning equipment. Available by the can or by a case of 6 and save! See chart below for details regarding color and application.

Note: Ships ground only. No air shipment.

16 oz. aerosol can	
K89166 specify color.....	16.99 ea
K89260 gray primer.....	16.99 ea
K89265 clear coat.....	16.99 ea
K89543 factory black.....	16.99 ea

Case of Six 16 oz. aerosol cans	
K8917 specify color.....	89.99 cs
K89261 gray primer.....	89.99 cs
K89266 clear coat.....	89.99 cs



Application Chart

Engine	Year	Notes	Color	16 oz. Can	Case of Six
170ci - L6	1960	exc. Valiant	turquoise	K89162	K89172
170ci - L6	1960-69	Valiant	red	K89164	K89174
198ci - L6	1973	all	blue	K89166	K89176
225ci - L6	1960	exc. Valiant	turquoise	K89162	K89172
225ci - L6	1970-74	all	blue	K89166	K89176
273ci - V8	1964-69	all	red	K89164	K89174
318ci - V8	1962-66	all	red	K89164	K89174
318ci - V8	1967-69	except Police	red	K89164	K89174
318ci - V8	1970-74	except Police	blue	K89166	K89176
318ci - V8	1968-70	Police engine	Hemi Orange	K89168	K89178
340ci - V8	1968	all	Red	K89164	K89174
340ci - V8	1969	all	Turquoise	K89162	K89172
340ci - V8	1970-71	all	Hemi Orange	K89168	K89178
340ci - V8	1972-73	all	Blue	K89166	K89176
360ci - V8	1971-74	all	Blue	K89166	K89176
361ci - V8	1960	Commando	Red	K89164	K89174
361ci - V8	1962-64	all	Turquoise	K89162	K89172
363ci - V8	1962-69	all	Turquoise	K89162	K89172
383ci - V8	1969-71	HP and Police	Hemi Orange	K89168	K89178
383ci - V8	1970-71	exc. HP, Police	Blue	K89166	K89176
400ci - V8	1972-74	all	Blue	K89166	K89176
413ci - V8	1962-63	all	Orange	K89160	K89170
413ci - V8	1964	race engine	Orange	K89160	K89170
413ci - V8	1964	all	Turquoise	K89162	K89172
413ci - V8	1965	all	Orange	K89160	K89170
426ci - V8	1963	Wedge	Orange	K89160	K89170
426ci - V8	1964	Wedge	Turquoise	K89162	K89172
426ci - V8	1964	Hemi race eng.	Orange	K89160	K89170
426ci - V8	1965-71	Hemi street eng.	Hemi Orange	K89168	K89178
426ci - V8	1966-68	Wedge	Turquoise	K89162	K89172
440ci - V8	1966-69	all	Turquoise	K89162	K89172
440ci - V8	1969-71	HP and Police	Hemi Orange	K89168	K89178
440ci - V8	1970-74	exc. HP, Police	Blue	K89166	K89176

OER® Metal Mimic FX Coatings

OER® Metal Mimic FX high performance coatings were developed to mimic the appearance of bare metal so that you can refresh and protect all of the components that were originally left unpainted by the factory. Items such as cast iron housings, aluminum housings, stainless steel parts, galvanized parts and even chrome can now be coated with a "factory correct" looking finish that is extremely durable and amazingly close to the original color. Metal Mimic FX high performance coatings are available individually.

Note: Ships ground only. No air shipment.

OER Metal Mimic FX Coatings - Individual 16 oz. Cans

K89500	Aluminum Blast Coating.....	12.99 ea
K89502	Cast Blast Cast Iron Gray Coating.....	12.99 ea
K89501	Galv Blast Zinc Coating.....	14.99 ea
K89091	Stainless Steel Coating.....	12.99 ea
K0090	Cast Iron Gray-High Temp.....	14.99 ea



OER® Factory Black Coatings

OER® factory black coatings

are available in a variety of sheen levels to help you achieve the correct factory look for your restoration. Our Ultra-Flat sheen is an extremely flat non-glare finish. The next level up is our low gloss formula followed by the semi-gloss and finally our exclusive high gloss formulation. Whatever you are spraying, we have the correct sheen for an original factory black look. *Note: Ships ground only. No air shipment.*

Factory Black Set - Contains all four formulations

Buy the complete OER Factory Black set and you will have all the necessary sheen levels for a correct factory look no matter what component you are spraying.

K89550	4 can set, all four sheens.....	59.99 set
--------	---------------------------------	-----------

Ultra Flat Factory Black

Extremely flat non-glare finish that is perfect for a variety of uses including underhood items like hood hinges, latches, carburetor parts, seat adjusters, pulleys, linkage nuts, bolts, washers, screws, clips, brackets and more. Provides a durable flat black zinc phosphate look without the high cost of black zinc phosphate plating.

K89540	16 oz. can.....	16.99 ea
K89590	case of six 16 oz. cans.....	89.99 cs

Low Gloss Factory Black

A durable low gloss coating that provides a factory fresh appearance on the frame, transmission crossmember, leaf spring shackles, control arms, firewall, cowl, brake components, AC compressor or anywhere else a low gloss, but not quite flat black finish is desired.

K89541	16 oz. can.....	16.99 ea
K89592	case of six 16 oz. cans.....	89.99 cs

Semi Gloss Factory Black

A durable low gloss coating that provides a factory fresh appearance on the underside of the hood or on inner fender skirts, battery tray, radiator support, master cylinder, front control arms, brackets, pulleys, fan blade, smog pump tail housing, starter, power steering assembly, horns, sway bars, wiper motor assembly and suspension components or anywhere else a semi gloss black finish is desired.

K89542	16 oz. can.....	16.99 ea
K89593	case of six 16 oz. cans.....	89.99 cs

High Gloss Factory Black

A high gloss coating that is perfect for restoration of air cleaner assemblies, valve covers, radiator tanks and brackets, ignition coils, voltage regulator covers, suspension springs, wheel inserts, shock absorbers, rear axle housings, differential tubes, brake backing plates and any other parts where a durable gloss black finish is desired.

K89543	16 oz. can.....	16.99 ea
K89594	case of six 16 oz. cans.....	89.99 cs

OER® Aerosol Coatings

OER® Rubberized Undercoating

A black, rubberized undercoating for all automobile under surfaces. Sprays evenly and dries completely to a smooth consistency. Can be topcoated with any type of automotive finish. Prevents rust, reduces road noise, seals out water, fumes, road chemicals & dirt. Special formula greatly reduces lingering odor associated with most other brands of undercoating. No "bleed through" when top coated. Use on undersides of panels, hoods & decks, trunk interiors, section repainers, weld joints, rust holes or on chassis parts. Buy the case and save!
Note: Ships ground only. No air shipment.
 K89570 20 oz. can..... 16.99 ea
 K89669 case of six..... 79.99 cs



OER® PBE Guide Coat Black

A fast dry black coating which enables the user to quickly identify the high and low areas on primed surfaces. Now you can achieve a professional, ultra smooth finish in an easy to use aerosol can. Apply one light coat over primed area. When dry, block sand the area to reveal high spots and depressions in the primed surface. Smoother finish than a conventional primer alone. Reduced overspray and fast drying formulation will lightly cover nearly 40 square feet.
Note: Ships ground only. No air shipment.
 K89571 12 oz. can..... 7.99 ea



OER® Black Wrinkle Finish

A durable and long lasting finish which has a unique wrinkled texture. Excellent hiding qualities provides an excellent finish for hiding surface imperfections such as pitting, scratches or chips. Extremely durable formula resists oil, gas and grease. Can be used where harsh conditions break down conventional coatings. Comes in 16 oz. aerosol can. Great for valve covers, air cleaners, dash components and more. Buy the case and save!
Note: Ships ground only. No air shipment.
 K89548 16 oz. can..... 12.99 ea
 K89549 case of six..... 69.99 cs



OER® Hi-Temp Exhaust Coat

A fast drying coating designed to withstand temperatures up to 1200 degrees F on a continuous basis. Forms a porcelain-like bond after curing. Resists blistering, peeling, discoloration, or loss of adhesion. Excellent for headers, manifolds, mufflers, pipes and more.
Note: Ships ground only. No air shipment.
16 oz. Can
 K89555 silver..... 14.99 ea
 K89556 black..... 14.99 ea
 K0090 cast iron gray.... 14.99 ea
Case of Six 16 oz. cans
 K89557 silver..... 79.99 cs
 K89558 black..... 79.99 cs
 K89559 cast iron gray.... 79.99 cs



OER® High Solids Detail Coatings

A superior professional grade coating formulated for restorations where maximum performance is required. These high solid paints do not run or sag and provide twice the coverage of conventional aerosol enamels. Each 20 oz. can offers the highest solid content (40%) of any aerosol paint on the market for maximum coverage. One 20 oz. can of OER High Solids is equal to four 16 oz. cans of competing brands.
Note: Ships ground only. No air shipment.



20 oz. Can		
K89577	gloss black.....	12.99 ea
K89578	flat black.....	12.99 ea
K89579	aluminum.....	12.99 ea
K89580	stainless steel.....	12.99 ea
K89581	dark gray.....	12.99 ea
Case of Six 20 oz. Cans		
K89577	gloss black.....	69.99 cs
K89678	flat black.....	69.99 cs
K89679	aluminum.....	69.99 cs
K89680	stainless steel.....	69.99 cs
K89681	dark gray.....	69.99 cs



OER® Professional Grade PBE Primers

OER® is pleased to offer our professional grade primers specifically formulated to meet the performance needs of body shop personnel but conveniently packaged for the automotive enthusiast. Tough and dependable, these primers adhere extremely well, prevent rust and corrosion and enhance the quality and appearance of the finished product. Large fan sprayhead gives a professional looking application. Eliminates the need for a spray gun for small repairs, reduces cleanup time. One 20 oz. can will cover as much area as four 16 oz. cans of a conventional low solids formulation.
Note: Ships ground only. No air shipment.

OER Self Etching Sanding Primers

Manufactured with a modified acrylic resin to give you excellent adhesion to all types of metal, aluminum and prepared surfaces. Dries to the touch in 10 minutes. Dry to sand or topcoat in 15 minutes. Available individually in 20 oz. cans or in case of six:

Individual 20 oz. Cans		
K89560	Gray.....	12.99 ea
K89561	Black.....	12.99 ea
K89562	Red Oxide.....	12.99 ea
Case of Six 20 oz. Cans		
K89660	Gray.....	69.99 cs
K89661	Black.....	69.99 cs
K89662	Red Oxide.....	69.99 cs

OER High Solids Sanding Primers

A superior professional grade primer formulated with 40% solids to provide twice the coverage of conventional aerosol primers. One 20 oz. can will cover as much area as four 16 oz. cans of a conventional low solids formulation. Fewer cans needed to complete the job to save you time and money. Protects against rust and corrosion. Provides excellent adhesion with single coat hiding capability and minimum overspray. Available individually in 20 oz. cans or in case of six.

Individual 20 oz. Cans		
K89575	Red Oxide.....	12.99 ea
K89576	Gray.....	12.99 ea
Case of Six 20 oz. Cans		
K89664	Red Oxide.....	69.99 cs
K89665	Gray.....	69.99 cs

OER Zinc Phosphate Primers

Specifically formulated primer that is chromate-free and chemically bonds with iron, steel and aluminum to form a hard, highly adherent coating. It has exceptional corrosion resistance. Ideal for spot repair of damaged coatings. Exceptional protection against rust and corrosion. Compatible under two component coatings. Forms a hard, highly adherent, water-resistant coating that can be painted or left as is. Dries to the touch in 10 minutes. Available individually in 16 oz. cans or in case of six.

Individual 16 oz. Cans		
K89565	Green.....	14.99 ea
K89566	Yellow.....	14.99 ea
Case of Six 16 oz. Cans		
K89666	Green.....	79.99 cs
K89667	Yellow.....	79.99 cs

OER Spray Galv Weld-Thru Coating

A smooth, cold galvanizing compound that chemically bonds with bare steel and forms an extremely rust-resistant barrier. Perfect for application on the inside of newly installed panels where rust prevention of new metal is important, but where the part treated will not be painted. Fast dry, sag-free spray that is abrasion resistant. Stops rust creepage, resists chemicals and is rust inhibitive. Apply it to sheet metal pieces before installation, then weld as usual. The coating will not affect the quality of the weld and will retain its rust-preventative properties. Available individually in 16 oz. cans or in case of six.

Individual 16 oz. Cans		
K89567	OER Spray Galv.....	16.99 ea
Case of Six 16 oz. Cans		
K89668	OER Spray Galv.....	89.99 cs

OER® Aerosol Coatings

OER® Underhood Detail Paint

The perfect alternative to expensive zinc phosphate plating. A variety of choices are available to correctly refinish underhood items such as hood hinges, hood latch and safety catch, carbs, pulleys, linkage, nuts, bolts, brackets, clips, screws and more with a durable flat or non-gloss finish that mimics the appearance of zinc phosphate plating.

Note: Ships ground only. No air shipment.
K89540 factory black..... 16.99 ea
K89520 dark gray..... 16.99 ea



OER® Clear Enamel

Provide extra durability and color depth on a variety of surfaces. OER Clear Enamel will enhance the appearance of engine components, wheels, suspension components and other painted and unpainted surfaces where a gloss clear topcoat is desired. Withstands rust, gas, oil grease, salt and intermittent temperatures up to 400 degrees F.

Note: Ships ground only. No air shipment.
K89265 gloss clear..... 16.99 ea



Experience Spray Gun Control!

Transform your aerosol container into a versatile spray gun. Using it's unique "lock-on" device, simply snap-it on and SPRAY! You'll experience better control for applying steady even coats, easy handling and comfort, all adding up to reduced fatigue. Use with paints, lubricants, cleaners, craft sprays and more! Universal fit for most aerosols.

81001 aerosol trigger grip..... 4.99 ea



OER ORIGINAL EQUIPMENT REPRODUCTION

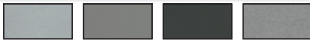

Argent Silver

Low Luster Gray

Charcoal Gray Metallic

Simulated Magnesium

OER® Factory Wheel Coatings

OER factory wheel coatings are available in a variety of original colors so you can achieve the correct factory look when restoring your wheels. Eliminates the need for expensive custom paint mixing and greatly simplifies the restoration process by providing spray gun results without the hassle and mess of a spray gun or the need for an air compressor. *Note: Ships ground only. No air shipment.*

Argent Silver Wheel Paint
Correct color and sheen for the restoration of Mopar Rally wheels grills, light bezels and other parts where Argent Silver was originally utilized.

K89320 16 oz. can..... 16.99 ea
K89321 case of six 16 oz. cans..... 89.99 cs

Low Luster Gray Wheel Paint

Correct color and sheen for the restoration of steel and mag wheels that call for a unique shade of gray. This gray was used on the backside and in some cases both sides of steel factory sport wheels. Can also be used on jack mechanism and jack base on some models.

K89410 16 oz. can..... 16.99 ea
K89411 case of six 16 oz. cans..... 89.99 cs

Charcoal Gray Metallic Wheel Insert Paint

Charcoal gray metallic paint for the restoration of the wheel insert area on various wheels. Correct color, tone and luster for a factory fresh appearance.

K89330 16 oz. can..... 16.99 ea
K89331 case of six 16 oz. cans..... 89.99 cs

Simulated Magnesium Wheel Paint

Correct color, sheen and texture for the restoration of magnesium wheels.

K89315 16 oz. can..... 16.99 ea
K89316 case of six 16 oz. cans..... 89.99 cs



black/gray

black/aqua

gray/white

OER® Trunk Refinish Kit

Customize the trunk area of your classic car and provide the ultimate protection from the elements. First prime the area to be painted. On bare metal, you should use a self etching primer. Next, spray your base coat. Then spray your spatter coat and let dry thoroughly. Finally, coat the entire surface with our clear topcoat to seal the surface. Buy the kit and save!

Note: Ships ground only. No air shipment.

Complete Trunk Refinishing Kit

Contains practically everything you need to refinish the trunk of your classic vehicle including 2 cans of primer, 2 cans of base coat, 3 cans of spatter paint and 2 cans of clear topcoat.

with Standard Gray Primer

K51490 black and gray..... 104.99 kit
K51491 black and aqua..... 104.99 kit

K51492 gray and white..... 104.99 kit

with Self Etching Gray Primer

K51493 black and gray..... 104.99 kit

K51494 black and aqua..... 104.99 kit

K51495 gray and white..... 104.99 kit

Trunk Refinishing Components

Need an extra can of any component from the Trunk Refinishing kit?

Primer Only - 20 oz. Cans

K89576 standard gray primer..... 12.99 ea

K89560 self etching gray..... 12.99 ea

Base Coat Only - 20 oz. Cans

K89578 flat black..... 12.99 ea

K89581 dark gray..... 12.99 ea

Spatter Coat Only - 16 oz. Cans

K51496 black and gray..... 12.99 ea

K51499 black and aqua..... 12.99 ea

K51498 gray and white..... 12.99 ea

Clear Topcoat Only - 16 oz. Cans

K51497 clear topcoat..... 12.99 ea

Reproduction Grill Emblems



1968 Coronet "R/T" Grill Emblem

Authentic die-cast reproduction "R/T" grill emblem for 1968 Coronet R/T models. Each emblem features correct red fill, bright accents, black edging and correct locating studs as original. Includes mounting hardware. Made in USA!

2786711 1968 Coronet 74.99 ea



1969 Charger Grill/Headlamp Door Emblem

Reproduction emblem located on the headlamp door of the 1969 Charger front grill assembly. Emblem features correct locating studs and finish as original. Includes mounting hardware. Made in USA!

2898929 1969 Charger 59.99 ea



1969 Charger 500 Grill Emblem

OER reproduction "Charger" grill emblem designed for 1969 Charger 500 models. Includes mounting hardware for installation. Made in USA!

2840066 1969 Charger 500 59.99 ea



1969 Super Bee Grill Emblem

Authentic die-cast reproduction Super Bee grill emblem for 1969 Dodge Super Bee models. Emblem features 3 fins on the locating studs that align it with the vertical rows on the 1969 Coronet grill. Includes mounting hardware. Made in USA!

2949303 1969 Super Bee 84.99 ea



1970 Challenger "R/T" Grill Emblem

Reproduction "R/T" grill emblem for 1970 Challenger models. Each emblem features correct mounting studs and finish as original. Mounting hardware is included. Made in USA! Replaces OE number 2998547.

ME18147 1970 Challenger 49.99 ea



1970 Charger Grill Emblem

Authentic die-cast reproduction "Charger" grill emblem for 1970 Charger models. Emblem features correct finish, black edging and mounting studs. Includes mounting hardware. Made in USA!

2998278 1970 Charger 54.99 ea



1970 Barracuda "Plymouth" Grill Emblem

Authentic die-cast reproduction "Plymouth" grill emblem for 1970 Barracuda models. Emblem features correct locating studs, font and finish for an original appearance. Includes mounting hardware. Made in USA!

2998282 1970 Barracuda 44.99 ea



1970-74 Challenger Grill Emblems

Authentic die-cast reproduction Challenger grill emblem for 1970-74 models. Each emblem features correct locating studs and black edging as original. Includes mounting hardware.

ME1751 1970 Challenger 39.99 ea
3573505 1972-74 Challenger Made in USA 47.99 ea

Reproduction Hood Emblems



1971-72 Charger Vertical Nose Emblem

Authentic die-cast reproduction front bumper emblem for 1971-72 Charger models. This emblem features correct colors, mounts on the center of the bumper and uses two speed nuts as original. Includes mounting hardware. Made in USA!
3464348 1971-72 Dodge arrow emblem..... 59.99 ea



PLYMOUTH



1963 B-Body "PLYMOUTH" Hood Letter Set

Reproduction "PLYMOUTH" hood letter set for 1963 B-Body models. Each letter is polished to match the original finish and includes mounting hardware. Mounts to hood on 1963 Belvedere and Savoy models, and 1963 Fury models. Made in USA!
MB1844 1963 P-L-Y-M-O-U-T-H..... 94.99 set



PLYMOUTH



1965 "PLYMOUTH" Hood Letter Set

Reproduction "PLYMOUTH" hood emblem lettering set for 1965 Belvedere models. Features the correct black center with polished border and includes mounting hardware. Made in USA!
MB1843 1965 P-L-Y-M-O-U-T-H..... 94.99 set



PLYMOUTH



1966-71 "PLYMOUTH" Hood Letter Set

Authentic die-cast reproduction "PLYMOUTH" letters that were installed on the hoods of various 1966-71 Plymouth models. Features correct locating studs. Includes mounting hardware. Made in USA!
RM4124 1966-71 P-L-Y-M-O-U-T-H..... 89.99 set



1967-68 Barracuda Hood Emblem

Authentic die-cast reproduction hood and trunk lid emblem for 1967-68 Barracuda models. Each emblem features correct "fish" design, bright chrome finish and correct locating studs for an original fit and appearance. Includes mounting hardware. Made in USA!
2784610 1967-68 Barracuda..... 44.99 ea



1967 GTX "440" Hood Ornament

Authentic die-cast reproduction 440 hood ornament for 1967 GTX models. This complete ornament features correct red paint, chrome accents and includes the base, gasket and retainer. The perfect addition to any restoration. Includes mounting hardware. Made in USA!
2785534 1967 GTX..... 79.99 ea



PLYMOUTH



1968-72 Plymouth Name Plate Emblem

Reproduction die-cast Plymouth emblem which install onto the hoods and header panels of various Mopar models. Includes correct locating studs and mounting hardware. Made in USA!

A-Body	
1968-69 Barracuda	
2785791 1968-69	"Plymouth" header panel emblem..... 49.99 ea
1969-72 Valiant	
2785791 1969-72	"Plymouth" hood emblem..... 49.99 ea
1970-72 Duster	
2785791 1970-72	"Plymouth" hood emblem..... 49.99 ea
B-Body	
1968-69 Belvedere	
2785791 1968-69	"Plymouth" hood emblem..... 49.99 ea
1971-72 Satellite 4 Door	
2785791 1971-72	"Plymouth" hood emblem..... 49.99 ea



MB2658



3613278



2898876



1969-70 B-Body Hood Emblems

Authentic reproduction 1969-70 B-Body "383", "440" and "HEMI" engine size callouts for 1969 Road Runner and GTX and 1969-70 Coronet R/T and Super Bee models with air induction options. Emblems feature correct locating studs for authentic fit and finish. Includes mounting hardware. Two emblems required per vehicle.
MB2658 1969-70 "383" Made in USA..... 29.99 ea
3613278 1969 "440" Made in USA..... 59.99 ea
2898876 1969-70 "HEMI" Made in USA..... 59.99 ea

Reproduction Hood Emblems



1970 Coronet "R/T" Hood Emblem



Authentic reproduction "R/T" center hood emblem for 1970 Coronet R/T models. Emblem features correct contours, red fill with silver accents, and correct locating studs. Includes mounting hardware. Made in USA!
2998066 1970 Coronet 59.99 ea

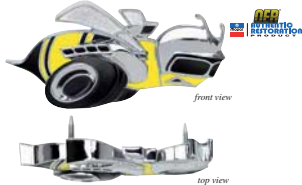

1970 Super Bee Hood Emblem



Reproduction hood emblem for 1970 Dodge Super Bee models. Follows the contours of the Coronet Super Bee hood exactly for a perfect fit and features correct colors and finish. Includes mounting hardware. Made in USA!
2998065 1970 Super Bee 59.99 ea



1972 Road Runner Header Panel Emblem

Reproduction header panel emblem for 1972 Road Runner models. This emblem is mounted on the center of the header panel and features correct embossed "Plymouth" lettering. Constructed in correct metal with original chrome finish. Emblem decal featuring the Road Runner® face and black background sold separately.
MB2071 1972 header panel emblem w/o decal 184.99 ea
MD4227 1972 road runner decal only 7.99 ea



1973-74 GTX Hood Emblem



Authentic reproduction "GTX" hood emblem for 1973-74 Road Runner GTX models. Features correct font and finish with black edging. Adhesive backed for easy peel and stick application. Made in USA!
3680160 1973-74 GTX 57.99 ea



1971-73 Charger "340 Magnum" Hood Emblem

Authentic reproduction 340 Magnum hood emblem which is installed on each side of the hood of 1971-73 Charger models equipped with a power bulge hood. Features correct font and finish for an authentic appearance. Made in USA!
3573632 1971-73 Charger 59.99 ea



3443159



2998796



2998798



2998801



2998802



1970-73 E-Body Hood Emblems

Reproduction engine callout emblems for 1970-73 E-Body models. Features correct colors and includes mounting hardware for easy installation. Made in USA!

1970-73 'Cuda	
3443159	1970-73 'Cuda-340 54.99 ea
2998796	1970-71 'Cuda-383 54.99 ea
2998798	1970-71 'Cuda-440-6 54.99 ea
1970-73 Challenger	
2998801	1970-71 383 Magnum 59.99 ea
2998802	1970-71 440 Magnum 59.99 ea



1967 Barracuda Fender Emblem

Authentic die-cast reproduction "Barracuda" fender emblem for 1967 Barracuda models. Each emblem features correct font and black fill with silver edging and correct mounting pins for an original appearance. Includes mounting hardware. Made in USA!

2582878 1967 Barracuda - 2 required 59.99 ea



2786591



1968 Barracuda V8 Fender Emblem

Authentic die-cast reproduction fender emblem for 1968 Barracuda models equipped with V8 engine. Each emblem features correct locating studs and paint colors. Includes mounting hardware. Made in USA!

2786591 1968 LH 46.99 ea
2786590 1968 RH 46.99 ea



Reproduction Fender Emblems

New!



2898938

2786559



1968 & 70 Barracuda Fender Emblem

Authentic die-cast reproduction "Barracuda" fender emblem for 1968 & 70 Barracuda models. Emblem features correct font and finish with correctly positioned mounting pins. Includes mounting hardware. 2 required. Made in USA!

2898938	1968	chrome	46.99	ea
2786559	1968 & 70	chrome with black trim	49.99	ea

New!



1969-70 Coronet "440" Fender Emblem

OER® reproduction of the "440" fender emblem for 1969-70 Dodge Coronet 440 models. These die-cast emblems feature correct marking and Pentastar logo as original. Includes mounting hardware. Made in USA!

2901810	1969-70	Coronet 440	49.99	ea
---------	---------	-------------	-------	----

New!



1969-72 Coronet Fender Emblem

OER® reproduction of the "Coronet" fender emblem for 1969-72 Dodge Coronet 440 models. These die-cast emblems feature all correct markings and the Pentastar logo as original. Includes mounting hardware. Made in USA!

2901751	1969-72	Coronet 440	49.99	ea
---------	---------	-------------	-------	----



1969-70 Dart Fender Emblem

Authentic die-cast reproduction "DART" fender emblem for 1969-70 Dart models. Each emblem features correct locating studs and paint color. Includes mounting hardware. Made in USA!

2901894	1969-70	Dart - 2 required	49.99	ea
---------	---------	-------------------	-------	----



1968-70 V-8 Fender Emblem

Authentic reproduction "V-8" fender emblem for select 1966-70 models with 8-cylinder engines. Emblem features correct silver finish with black edging and correct mounting studs. Includes mounting hardware. Made in USA!

1968-69 Dart	1967 Charger			
1966-70 Belvedere	1970 Challenger			
1966-70 Coronet				
2579748	1966-70	"V8" - 2 required	29.99	ea



3680160



1967-74 GTX Fender Emblems

Authentic reproduction "GTx" fender emblem for 1967-74 GTX models. Emblem features correct font, silver finish with black edging for an original appearance. Made in USA!

2785518	1967	mounting pin back	3-1/2"	42.99	ea
3680160	1972-74	adhesive back	2-3/4"	57.99	ea

New!



MD7087



MD7086

1967-72 Fender Pentastar Emblem

OER® reproduction Pentastar fender emblem for various 1967-72 models. Each emblem mounts on the lower part of the RH fender on most models. Features correct gold or silver finish and mounting pin on back as original. Officially licensed Mopar Authentic Restoration Product.

MD7087	1967-72	gold	7.99	ea
MD7086	1967-72	silver	7.99	ea



1966-71 383 Fender Emblem - Black

Authentic reproduction "383 FOUR BARREL" fender emblem. Each emblem features correct font, color and mounting studs as original. Includes mounting hardware. 2 emblems required per vehicle. Made in USA!

1967 Barracuda	1968 Dart GTS			
1966 Charger	1969-70 Coronet			
1969-70 Super Bee	1970-71 Barracuda			
2579804	1966-71	"383 FOUR BARREL" black emblem	44.99	ea



1966-71 383 Fender Emblem - Red

Authentic reproduction "383 FOUR BARREL" fender emblem which may be installed on a variety of Dodge and Plymouth A & E-Body vehicles. Each emblem features correct font, color and mounting studs as original. Includes mounting hardware. 2 emblems required per vehicle. Made in USA!

1967 Barracuda	1968 Dart GTS			
1966 Charger	1969-70 Coronet			
1969-70 Super Bee	1970-71 Barracuda			
2785749	1966-71	"383 FOUR BARREL" red emblem	44.99	ea

Fender & Door Emblems

New!



OEER AUTHENTIC REPRODUCTION

Made in USA

1970-72 Challenger Fender Emblem

Authentic die-cast reproduction "Challenger" emblem, which installs on the fenders of 1970-72 Challenger models. Available in a 3 pin mounting style or adhesive backed design for easy peel and stick application. The 3 pin mounting style includes hardware. Made in USA!

3444938 1970-72 Challenger - adhesive backed..... 59.99 ea
3445224 1970-72 Challenger - 3 pin style..... 49.99 ea



OEER AUTHENTIC REPRODUCTION

Made in USA

1971 Charger Fender Emblem

Authentic die-cast reproduction "Charger" fender emblem for 1971 Charger models. Features correct font and finish for an authentic appearance. Attaches with correct mounting studs as original. Includes mounting hardware. Made in USA!

3504807 1971 Charger - 2 required..... 59.99 ea



OEER AUTHENTIC REPRODUCTION

Made in USA

1971-74 Charger Fender Emblem

Authentic die-cast reproduction arrow emblem for 1971-74 Charger models. Features correct black, white and red fill with chrome edging. Made in USA!

3506410 1971-74 arrow emblem - 2 required..... 59.99 ea



OEER AUTHENTIC REPRODUCTION

Made in USA

1972-74 'Cuda Fender Emblem

Reproduction die-cast "Cuda emblem for 1972-74 'Cuda models. Features correct finish and font for an authentic appearance. This adhesive backed emblem is applied to the front fenders of 1972-74 models. Made in USA!

ME1750 1972-74 'cuda emblem - 2 required..... 34.99 ea

Made in USA



OEER AUTHENTIC REPRODUCTION

1971 Super Bee Fender Emblem

Reproduction front fender emblem for 1971 Charger Super Bee models. Manufactured as original with chrome lettering and black accents. Features the correct locating studs for an authentic appearance. Sold individually. Made in USA!

3504804 1971 Super Bee - 2 required..... 59.99 ea



OEER AUTHENTIC REPRODUCTION

Made in USA

1971-74 Dart Fender Emblem

Authentic die-cast reproduction "DART" emblem which was installed in various locations including the front fenders on 1971-74 Dodge Dart models. Each emblem features correct locating studs as original. Includes mounting hardware. Made in USA!

3505419 1971-74 Dart - 2 required..... 49.99 ea



OEER AUTHENTIC REPRODUCTION

Made in USA

1972 Demon Fender Emblem

Authentic die-cast reproduction "Demon" fender emblem for 1972 Demon models. Each emblem features correct locating studs and yellow and red fill with chrome edging for an authentic appearance. Includes mounting hardware. Made in USA!

3680247 1972 Demon - 2 required..... 49.99 ea



OEER AUTHENTIC REPRODUCTION

Made in USA

1972-76 Duster Fender Emblem

Authentic die-cast reproduction "DUSTER" emblem which is installed on each fender of 1972-76 Plymouth Duster models. Emblem features correct white fill with silver edging and locating studs. Includes mounting hardware. Made in USA!

3680304 1972-76 Duster - 2 required..... 64.99 ea



OEER AUTHENTIC REPRODUCTION

Made in USA

MB1841

1970 Charger "R/T" Door Emblem

Reproduction "R/T" emblem for 1970 Charger and Coronet models. Manufactured to factory specifications with either original mounting studs or with 3M backing for simple installation. This emblem was mounted to the door on Charger models. Replaces OE number 3445919. Made in USA!

MB1841 1970 Caharger "R/T" emblem with studs..... 39.99 ea
MB1842 1970 Charger "R/T" emblem with 3M backing..... 39.99 ea



OEER AUTHENTIC REPRODUCTION

Made in USA

1973-74 Charger Door Emblem

Authentic die-cast reproduction "Charger" door emblem for 1973-74 Charger models. Features correct font and finish for an authentic appearance. Adhesive backed design as original for easy peel and stick application. Made in USA!

3504807A 1973-74 Charger - 2 required..... 59.99 ea

Made in USA



OEER AUTHENTIC REPRODUCTION

1971-74 Charger Door Emblem

Authentic die-cast reproduction arrow emblem for 1971-74 Charger models. Features correct black, white and red fill with chrome edging as original. Made in USA!

3506410 1971-74 arrow emblem - 2 required..... 59.99 ea

Door, Dash & Quarter Emblems



1968-69 Road Runner Door Emblems

Reproduction "road runner" emblems for 1968-69 Road Runner models. These emblems mount in various locations depending on vehicle model year. The door emblem is offered as a metal insert only or as a complete assembly with metal insert and die-cast metal bezel. The metal insert only is an adhesive-backed nameplate that adheres to your original bezel through peel-and-stick application, while the metal insert with die-cast metal bezel uses speed nuts to mount to your vehicle just like the original. All emblems include mounting hardware where applicable.

2785877	1968	"road runner" metal insert with die-cast bezel	39.99 ea
MB6869	1968	"road runner" metal insert only	19.99 ea
K699	1969	"road" & "runner" script emblem set	59.99 set



1971-74 Barracuda Door Emblem

Authentic die-cast reproduction Barracuda door emblem for 1971-74 non-performance models. Emblem features correct font and finish and correctly located mounting pins for an original fit and appearance. Includes mounting hardware. Made in USA!

3505456	1971-74	Barracuda - 2 required	39.99 ea
---------	---------	------------------------------	----------



1970-74 E-Body Dash Emblems

Reproduction dash pad emblems for 1970-74 E-Body models. 1970 Challenger and Barracuda emblems are made from injection molded ABS and feature chrome lettering. 1971-74 Challenger and Barracuda emblems feature an embossed metal insert attached to a plastic bezel, as original. 1971-74 emblems are also available as a metal insert only without the plastic bezel for use when your original bezel is intact. All emblems include mounting hardware where applicable.

1970-74 Challenger			
ME8167	1970	Challenger script emblem	34.99 ea
ME7177	1971-74	Challenger emblem insert only - OER®	19.99 ea
3590127	1971-74	Challenger emblem insert w/bezel - OER®	34.99 ea
1970-74 Barracuda			
ME8166	1970	Barracuda script emblem	34.99 ea
ME7178	1971-74	Barracuda emblem insert only - OER®	19.99 ea
3590126	1971-74	Barracuda emblem insert w/bezel - OER®	34.99 ea



1968-69 Road Runner Dash Emblem

Reproduction "road runner" dash emblem insert and bezel for 1968-69 Road Runner models. The metal insert is adhesive backed for easy peel and stick application while the complete metal insert and die-cast metal bezel assembly uses speed nuts to mount to dash. Mounting hardware is included where applicable.

2785877	1968-69	"road runner" metal insert with die-cast bezel	39.99 ea
MB6869	1968-69	"road runner" metal insert only	19.99 ea



1967 & 1970 Dodge SE Quarter Panel Emblem

Authentic reproduction Special Edition quarter panel emblem for 1967 Coronet 500 and R/T models and also for 1970 Charger 500 and R/T models. Each emblem features correct font and Fratzlog logo. Includes mounting hardware. Made in USA!

2782966	1967	Coronet 500, R/T	59.99 ea
2782966	1970	Charger 500, R/T	59.99 ea



1970 Coronet "R/T" Quarter Scoop Emblem

Reproduction "R/T" emblem for 1970 Coronet models. Manufactured to factory specifications with either original mounting studs or with 3M backing for simple installation. This emblem was mounted on the quarter scoops of Coronet models. Replaces OE number 3445919. Made in USA!

MB1841	1970	"R/T" emblem with studs	39.99 ea
MB1842	1970	"R/T" emblem with 3M backing	39.99 ea



1970-74 Road Runner Quarter Panel Emblems

Authentic die-cast reproduction "road runner" emblem for 1970-74 Road Runner and Superbird models. This emblem mounts on various locations depending on vehicle model year and uses speed nuts just like the original. Includes mounting hardware. Made in USA!

K699	1970-74	"road" & "runner" emblem set	59.99 set
------	---------	------------------------------------	-----------



1973-74 Challenger Quarter Panel Emblem

Authentic die-cast reproduction "Challenger" emblem, which installs on the quarter panels on 1973-74 Challenger models. Available in a 3 pin mounting style or adhesive backed design for easy peel and stick application. The 3 pin mounting style includes hardware. Made in USA!

3444938	1973-74	Challenger - adhesive backed	59.99 ea
3445224	1973-74	Challenger - 3 pin style	49.99 ea

Trunk Emblems

New!

DODGE



1965 Coronet Sedan "DODGE" Trunk Emblem

Reproduction "DODGE" trunk emblem for 1965 Coronet models. Manufactured to factory specifications featuring the correct font and bright chrome finish.

MB280990 1965 Coronet sedan 99.99 set

PLYMOUTH



1966-71 A-Body "PLYMOUTH" Trunk Lid Letter Set

Authentic die-cast reproduction "PLYMOUTH" letters which were installed on the trunk lids of various 1966-71 Plymouth A-Body models. Features correct mounting studs and includes mounting hardware. Made in USA!

RM4124 1966-71 P-L-Y-M-O-U-T-H 89.99 set

1967-68 Barracuda Trunk Lid Emblem

Authentic die-cast reproduction trunk lid emblem for 1967-68 Barracuda models. Each emblem features correct mounting studs and finish for an original fit and appearance. Includes mounting hardware. Made in USA!



2784610 1967-68 Barracuda 44.99 ea

New!

Charger



1968 Charger Rear Panel Emblem

OER® reproduction "Charger" rear panel emblem for 1968 Charger R/T and 2 door hardtop models. Includes mounting hardware for installation. Made in USA!

2840066 1968 Charger R/T 59.99 ea

2840066 1968 Charger 2 door hardtop 59.99 ea

PLYMOUTH



1968-69 Valiant "PLYMOUTH" Trunk Lid Emblem

Reproduction die-cast "PLYMOUTH" emblem which is installed on the trunk of 1968-69 Valiant models. Includes correct mounting pins and mounting hardware. Made in USA!

2785791 1968-69 Valiant 49.99 ea

New!

Swinger



1970 Dart "Swinger" Trunk Emblem

OER® reproduction of the "Swinger" trunk emblem for 1970 Dodge Dart models. This die-cast emblem features the correct colors and markings as original. Includes mounting hardware. Made in USA!

3446102 1970 Dart Swinger 49.99 ea



DUSTER

1972-76 Duster Trunk Lid Emblem



Authentic die-cast reproduction "DUSTER" emblem which is installed on the trunk lid of 1972-76 Plymouth Duster models. Emblem features correct mounting pins. Includes mounting hardware. Made in USA!

3680304 1972-76 Duster 64.99 ea



DART

1973-74 Dart Sport Trunk Lid Emblem



Authentic die-cast reproduction "DART" emblem which was installed in various locations including the rear trunk lid of 1973-74 Dart Sport models. Each emblem is produced in correct finish and features correct locating studs as original. Includes mounting hardware. Made in USA!

3505419 1973-74 Dart 49.99 ea



PLYMOUTH



1963-64 B-Body "PLYMOUTH" Trunk Letter Set

Reproduction "PLYMOUTH" trunk letter set for 1963-64 B-Body models. Each letter is polished to match the original finish and includes mounting hardware. Correct for 1963 Belvedere and 1963-64 Savoy models. Made in USA!

MB1844 1963-64 P-L-Y-M-O-U-T-H 94.99 set



PLYMOUTH



1965 "PLYMOUTH" Trunk Letter Set

Reproduction "PLYMOUTH" trunk emblem lettering set for 1965 Belvedere models. Features the correct black center with polished border and includes mounting hardware. Made in USA!

MB1843 1965 Belvedere 94.99 set



1965-67 Charger & Coronet Trunk Emblem Bezel & Assemblies

Reproduction trunk lid bezels and assemblies for 1965-67 Coronet and Charger models. Available as the bezel only, which surrounds the trunk lid emblem, or as an assembly that includes the emblem. Features correct finish and colors for an authentic appearance.

1965 Coronet Trunk Lid Medallion			
MB2107	1965	440/500 models, bezel only	144.99 ea
MB2652	1965	440 assembly	274.99 ea
MB2653	1965	500 assembly	294.99 ea

1966-67 Charger Trunk Lid Medallion			
MB2100	1966-67	assembly	259.99 ea
MB2101	1966-67	insert only	134.99 ea
MB2102	1966-67	base only	154.99 ea

Mounting Gasket			
MB184609	1966-67	sold as pair	9.99 pr

Trunk Emblems



PLYMOUTH

1966-73 B-Body "PLYMOUTH" Trunk Lid Letter Set

Authentic die-cast reproduction "PLYMOUTH" letters which were installed on the trunk of various 1966-73 Plymouth B-Body models. Features correct font, finish and mounting studs. Includes mounting hardware. Made in USA!

RM4124 1966-73 P-L-Y-M-O-U-T-H..... 89.99 set



HEMI

1967-69 Belvedere "HEMI" Trunk Lid Emblem

Authentic reproduction "HEMI" trunk lid emblem which installs on 1967-69 Belvedere models. Emblem features correct HEMI font, silver face and mounting studs. Includes mounting hardware. Made in USA!

2840867 1967-69 Belvedere..... 39.99 ea



GTX

1967 GTX Trunk Lid Emblem

Authentic die-cast reproduction "GTX" emblem which is installed on the rear trunk lid and between the rear seats of 1967 Plymouth GTX models. Features correct silver finish with black edging for an authentic appearance. This emblem measures 2-3/4" in length. Emblems feature correct mounting studs as original. Includes mounting hardware. Made in USA!

2840214 1967 GTX..... 42.99 ea



road runner

1969-74 Road Runner Deck Lid Emblems

Authentic die-cast reproduction "road runner" emblem for 1969-74 Road Runner and Superbird models. This emblem mounts on various locations depending on vehicle model year and uses two speed nuts just like the original. Includes mounting hardware. Made in USA!

K699 1973-74 Road Runner..... 59.99 set
K699 1969-70 Road Runner/Superbird..... 59.99 set



Charger

1971 Charger Trunk Lid Emblem

Authentic die-cast reproduction "Charger Dodge Division" emblem, which installs onto the trunk lid of 1971 Charger models. Features correct font and finish and adhesive backed design as original for easy peel and stick application. Made in USA!

3570035 1971 Charger Dodge Division..... 49.99 ea



road runner road runner

2785877

MB6869

1968 Road Runner Trunk Lid Emblem and Insert

Authentic die-cast reproduction "road runner" trunk emblem for 1968 Road Runner models. Available as an insert only, or as an insert with the die-cast metal bezel. Each insert features adhesive backing for an easy peel and stick application, while the insert with the die-cast metal bezel attaches with studs and speed nuts as original.

2785877 1968 "road runner" metal insert with die-cast bezel 39.99 ea
MB6869 1968 "road runner" metal insert only..... 19.99 ea



1969 Super Bee Trunk Lid Emblem

Authentic die-cast reproduction Super Bee trunk lid emblem for 1969 Dodge Super Bee models. Manufactured in the correct style with yellow/black coloring and chrome trim. Includes mounting hardware. Made in USA!

294635 1969 Super Bee..... 59.99 ea



GTX



1972 GTX Trunk Lid Emblem

Authentic reproduction "GTX" emblem which installs on the trunk lid of later GTX models. Features correct font and finish. Adhesive-backed design with locating pins on rear. Simple peel and stick application. Made in USA!

3680160 1972 GTX..... 57.99 ea



Challenger

1970 Challenger Trunk Lid Emblem

Authentic die-cast reproduction "Challenger" emblem, which installs onto the trunk lid of 1970 Challenger models. Available in a 3 pin mounting style or adhesive backed design for easy peel and stick application. The 3 pin mounting style includes hardware. Made in USA!

3444938 1970 Challenger - adhesive backed..... 59.99 ea
3445224 1970 Challenger - 3 pin style..... 49.99 ea



Tail Panel Emblems



1968 Charger Tail Panel Emblem



Authentic die-cast reproduction tail panel arrow emblem for 1968 Charger models. Emblem features correct black, white and red fill and mounting studs as original. Includes mounting hardware. Made in USA!
2840065 1968 Charger..... 49.99 ea



2842387

MF1724

1968 Plymouth B-Body Tail Panel Emblem

OER® reproduction "Satellite" or "GTX" tail panel emblem. Each die-cast reproduction is manufactured to exact factory original Mopar specifications featuring the correct chrome finish and markings on rear of emblem. For ease of installation, OER® supplies push-style retaining nuts with each emblem. However, for a factory original installation, these emblems may be installed by "spin welding" the emblem to the rear panel, provided installer has the proper equipment and experience with the "spin welding" procedure. Officially licensed Mopar Authentic Restoration Product.
2842387 1968 Satellite..... 69.99 ea
MF1724 1968 GTX..... 69.99 ea



2902389

2965253

1969-70 Charger "R/T" Tail Panel Emblem

Authentic die-cast reproduction "R/T" emblems which install on the tail panel of 1969-70 Charger R/T models. Each emblem features correct font, red fill, silver edging and mounting studs for an original appearance. Includes mounting hardware. Made in USA!
2902389 1969 Charger..... 44.99 ea
2965253 1970 Charger..... 59.99 ea



1969-70 Charger Tail Panel Emblem

Authentic die-cast reproduction tail panel emblem for 1969-70 Charger models. Features red/black painted arrows with chrome accents as original. Manufactured in the USA!
2902306 1969-70 Charger..... 54.99 ea



1970 Coronet "500" Rear Finish Panel Emblem

Authentic reproduction "500" emblem which mounts on the rear finish panel of 1970 Charger 500 and 1970 Coronet 500 models. This is the rivet-on version that features a short 3/16" molded-in die-cast rivet stud. Emblem is installed on the panel by rivet peening. Made in USA!
3505338 1970 Coronet 500..... 27.99 ea



1970 Coronet "R/T" Tail Panel Emblem



Authentic die-cast reproduction "R/T" tail panel emblem for 1970 Coronet models. Features correct red/black painted letters and chrome accents for an as original appearance. Made in USA!
3444609 1970 Coronet R/T..... 64.99 ea



1970-74 'Cuda Tail Panel Emblem



This die-cast reproduction 'Cuda tail panel emblem is correct for late 1970 models and all 1971-74 models. Features adhesive backing and correct finish and font for an original appearance. Made in USA.
Note: Correct for 'Cuda models built after April 1, 1970.
ME1750 1970-74 'Cuda..... 34.99 ea



1971-74 Barracuda Tail Panel Emblem



Authentic die-cast reproduction "Barracuda" tail panel emblem for 1971-74 non-performance Barracuda models. Emblem features correct mounting pins, font and finish for an as original appearance. Includes mounting hardware. Made in USA!
3505456 1971-74 Barracuda..... 39.99 ea



1963-66 Sport Fury Emblem

Reproduction Sport Fury emblem for placement on various locations of 1963-66 Plymouth Sport Fury models. Manufactured to factory specifications featuring the correct script and finish.

MB184615	1963	front fenders/deck lid.....	44.99 ea
MB184615	1964	deck lid.....	44.99 ea
MB184615	1965	front fenders.....	44.99 ea
MB184615	1966	deck lid.....	44.99 ea

Body Emblem Barrel Nuts

These are the nuts needed to install body emblems on your A, B, or E-Body. The barrel nuts are push on style, rather than the original twist on style, as this style will not require removal of body panels for emblem installation.



MM2267



MM2268

MM2267	for 1/8" diameter pins.....	.69 ea
MM2268	for 3/16" diameter pins.....	.69 ea

Custom Emblems



CM5185



CM5186



CM5188

Custom Adhesive-Back Numbers

Announce the engine size of your choice on the side of your Mopar with these chrome plated, die-cast numerals. Each numeral features a strong self-adhesive backing with no studs, so there is no need to drill holes in your car. Can be used for the fender, quarter panel, rear panel, roof panel or virtually anywhere there's a surface to stick to. Available with black, white or red painted face. Specify color and number(s) when ordering.

Note: Each number is 5/8" tall by varying widths (approximately 1-1/2" wide).

CM5185	black numerals.....	16.99 ea
CM5186	white numerals.....	16.99 ea
CM5188	red numerals.....	16.99 ea



383 Billet Fender Emblems

These billet 383 fender emblems are the perfect way to proclaim your engine size to the world. These finely crafted emblems are CNC laser cut from T6061 aluminum. Made in USA.

Note: No further discounts apply.

MD1014	383.....	114.99 set
--------	----------	------------



Polished Stainless Steel 383 Emblems

Let the world see just how many cubes are lurking under your hood with this engine size emblem to customize your car! Show your engine size with this exceptional laser cut polished stainless steel emblem that attach with 3M adhesive tape. Sold in pairs.

14556	383.....	44.99 pr
-------	----------	----------



Proud of Your Equipment? Show Them with a Retro Hurst Emblem!

Based on original Hurst blueprints, this Hurst Equipped emblem is an authentic reproduction of the one used on the late 60's muscle cars equipped with a factory Hurst shifter. Made of durable ABS plastic with 3M adhesive tape backing for an easy installation. Measures 1-1/4" x 5-1/4".

Note: No further discounts apply.

1361000	Hurst Equipped emblem.....	19.99 ea
---------	----------------------------	----------



CM38364

CM38368



CM38370

CM57269

CM57264

Custom Engine Callout Emblems

If you are building a custom car and want to add a custom touch to your fenders, hood scoops or just about any place on your car's body, check out these custom engine callout emblems. Measurements and pin diameter are given, as well as the emblem nuts that will retain these emblems.

Part#	Callout	Height	Width	Pin Dia.	Pin Distance	Price
C38364	383	1-1/16"	1-3/8"	1/8"	3/4"	29.99 pr
C38368	383	1-1/16"	4-3/8"	3/16"	4-1/16"	49.99 pr
C38369	383	3/4"	4-3/8"	3/16"	3-5/8"	49.99 pr
C38370	383	7/8"	4-1/8"	1/8"	2-3/4"	49.99 pr
CS7264	572	1-1/16"	1-3/8"	1/8"	3/4"	39.99 pr
CS7269	572	3/4"	4-3/8"	3/16"	3-5/8"	49.99 pr

Emblem Speed Nuts

11502547	1/8"	individual.....	1.49 ea
11501047	3/16"	individual.....	.99 ea
R401	1/8"	kit of 8.....	9.99 kit
R402	1/8"	kit of 4.....	4.99 kit
R403	3/16"	kit of 4.....	2.99 kit
R404	3/16"	kit of 8.....	6.99 kit



Plastic and Emblem Adhesive

This 3M adhesive is designed for interior and exterior trim such as emblems, moldings, tail lamp lenses, and vinyl trim. It is formulated to dry quickly and is resistant to water, heat, and fuel.

03601	1 oz tube.....	4.99 ea
-------	----------------	---------



Quick Set Auto Epoxy

This fast curing, non shrinking, colorless epoxy comes in a convenient 2-part dispensing syringe. Bonds most rigid materials and resists most solvents. Versatile and shock resistant. For use with auto trim moldings, ornaments, emblems, knobs, etc.

S81787	1 fl. oz.....	4.99 ea
--------	---------------	---------

Scotch-Mount Attachment Tape

Closed cell foam tape coated on both sides with a pressure-sensitive adhesive. Designed for attaching trim moldings, emblems and other articles where high internal strength is required.

06377	1/2" x 20 yards.....	35.99 ea
06378	7/8" x 20 yards.....	54.99 ea

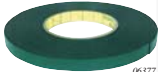

06377

Reproduction Decals



1969-70 GTX & Road Runner Hood Decals

Reproduction 440 hood decals for 1969-70 GTX and Road Runner models. The "440 6 BBL" decal is for the 1969 Road Runner models with fiberglass hood and the "440+6" decal is for 1970 GTX and Road Runner models equipped with a 440 6-bbl engine.

MS433 1969 "440 6 BBL"..... 19.99 ea
MS437 1970 "440+6"..... 19.99 ea



1969 Super Bee Hood Scoop Decal

Reproduction "SIX PACK" hood scoop decal for 1969 Super Bee models. This decal is applied on each side of the fiberglass hood scoop.

MD4206 1969..... 29.99 pr



1971-72 Hood Bezel Decals

Reproduction hood bezel decals for 1971-72 Road Runner and GTX models. Sold each. Two required per vehicle.

MD1647 1971 blk w/wht num 340..... 24.99 ea
MD4216 1971 blk w/wht num 383..... 24.99 ea
MD4217 1971 wht w/blk num 383..... 24.99 ea
MD4218 1971 blk w/wht num 440..... 24.99 ea
MD4219 1971 wht w/blk num 440..... 24.99 ea
MD4220 1971 blk w/wht num 440+6..... 24.99 ea
MD4221 1971 wht w/blk num 440+6..... 24.99 ea
MD4222 1972 wht w/blk num 340..... 24.99 ea
MD4223 1972 wht w/blk num 400..... 24.99 ea
MD4224 1972 wht w/blk num 440..... 24.99 ea
MD1649 1972 wht w/blank..... 24.99 ea



1971-72 383 Fender Decal

Reproduction "383" fender decals for all 1971 Plymouth models equipped with the air grabber system. This decal is applied on each fender above the side markers.

MD4208 1971 white #s..... 14.99 ea
MD4209 1971 black #s..... 14.99 ea



1971-74 Plymouth Engine Call Out Decals

Reproduction reflective individual engine size callout decals for 1971-74 Road Runner and GTX models.

MD4212 1971-74 white 440..... 14.99 ea
MD4213 1971-74 black 440..... 14.99 ea
MD4214 1971 white 440+6..... 14.99 ea
MD4215 1971 black 440+6..... 14.99 ea
MS512BK 1971 black "Hemi"..... 14.99 ea
MS511BK 1974 black "360"..... 14.99 ea
MD4225 1972-74 white 400..... 14.99 ea
MD4226 1972-74 black 400..... 14.99 ea
MD4210 1971-73 white 340..... 14.99 ea
MD4211 1971-73 black 340..... 14.99 ea



1971-74 Duster Hood/Quarter Decals

Reproduction hood and quarter panel decals for 1971-74 Duster models. These decals specify the engine option and were placed on the front of the hood and rear of the quarter panel. Hood decals are available in black & white (BK), or black/red/white (RD). Quarter decals are available in matte black (BK), or white (WH).

Hood Decals

MS339BK 1971 340 Wedge..... 49.99 ea
MS339RD 1971 340 Wedge..... 49.99 ea
MS340BK 1971-72 440 Wedge..... 49.99 ea
MS340RD 1971-72 440 Wedge..... 49.99 ea

Quarter Panel Decals

MS341ABK 1971-74 340..... 19.99 pr
MS341AWH 1971-74 340..... 19.99 pr
MS341BBK 1971-74 360..... 19.99 pr
MS341BWH 1971-74 360..... 19.99 pr
MS341CBK 1971-74 383..... 19.99 pr
MS341CWH 1971-74 383..... 19.99 pr
MS341DBK 1971-74 440..... 19.99 pr
MS341DWH 1971-74 440..... 19.99 pr

1968-70 Super Bee Quarter Panel Decals

Reproduction quarter panel decals for non-stripe 1968-70 Super Bee models. These decals are applied on the rear end of each quarter panel.

MS386BK 1968-70 black..... 59.99 pr
MS386WH 1968-70 white..... 59.99 pr
MS386RD 1968-70 red..... 59.99 pr
MS386GR 1970 green..... 59.99 pr



1968-71 Super Bee Individual Decals

Reproduction individual decals for 1968-71 Super Bee models. These quality reflective decals will replace your faded originals for a fresh appearance.

MS392 1968-71 LH fender..... 13.99 ea
MS393 1968-71 RH fender/deck lid..... 13.99 ea



1970 Rear Side Window SCAT PACK Bees

Reproduction multi-colored rear side window SCAT PACK Bee decals for 1970 Road Runner models.

MS520 1970 SCAT PACK Bee..... 13.99 pr



1971 Ramcharger Air Door Decal

Reproduction Ramcharger air door decal for 1971 Charger and Super Bee models. This decal is for models equipped with the Ramcharger hood.

MS370 1971..... 29.99 pr



1970-72 Plymouth Air Grabber Door Decal

Reproduction air grabber door decals for 1970-72 GTX and Road Runner models. Replace your damaged original with this reproduction. These decals are applied to each side of the hood door.

MS399 1970 teeth decals..... 29.99 pr
MS422 1971-72 teeth decals..... 29.99 pr
MS513 1971-72 door top letters..... 14.99 ea

1969-72 Road Runner

Horn Button Decal

Reproduction standard steering wheel horn button decal for Road Runner models. Freshen-up that standard steering wheel horn button with this quality reproduction decal.

MW795 1969-70..... 9.99 ea
MD4176 1972..... 6.99 ea

1971 Plymouth

Header Panel Decal

Reproduction black/white header panel decal for 1971 Road Runner and GTX models. This circular decal is applied to the center of the header panel.

MS486 1971..... 15.99 ea

1972 Header Panel Decal

Reproduction header panel decal for 1972 Road Runner models. This decal is applied on the medallion that mounts in the center of the header panel.

MD4227 1972..... 7.99 ea

Reproduction Decals

New!



1964-65 A-Body Rocker Molding Decals

Reproduction rocker molding decals for 1964-65 Barracuda and 1964 Valiant models. These high quality decals will save you hours of masking and painting time. One decal sheet provides enough decals for one rocker molding, two decal sets required per vehicle. MP41265 1964 Valiant..... 24.99 set MP41265 1964-65 Barracuda..... 24.99 set

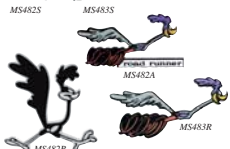

1968-75 Road Runner Decals

Individual reproduction bird decals for 1968-75 Road Runner models. These decals are applied in different locations depending on the year of the vehicle and all feature correct colors and reflective material.

Standing Decals		
MS482S	1968	black/white..... 14.99 ea
MS483S	1969-75	colored..... 19.99 ea
MS484	1971-75	w/circle..... 19.99 ea
Running Decals		
MS482A	1968	w/alum. deck panel. 19.99 ea
MS482L	1968	LH..... 14.99 ea
MS482R	1968	RH..... 14.99 ea
MS483L	1969-75	LH..... 14.99 ea
MS483R	1969-75	RH..... 14.99 ea



1971 R/T Hood Decal

Reproduction small R/T pinstripe hood decals for 1971 Charger and Challenger R/T models. These decals will replace your faded originals exactly for a showroom-new look. MS379BK 1971 matte black..... 19.99 ea MS379WH 1971 white..... 19.99 ea



1970-76 Duster Decals

Reproduction decals for 1970-76 Duster models. These quality decals will replace faded or damaged originals for a showroom appearance.

Fender Decals		
MS346	1970-72	"Duster"..... 14.99 ea
MS347	1970	"340"..... 9.99 ea
MS349	1970-75	"Gold Duster"..... 14.99 ea
MS351	1976	"Feather Duster"..... 14.99 ea
"Twister" Quarter Panel Decals		
MS350BK	1971-72	black..... 14.99 ea
MS350WH	1971-72	white..... 14.99 ea
MA1176	1973-74	black..... 14.99 ea
MA1177	1973-74	white..... 14.99 ea
Tail Panel Decals		
MS348	1970-72	"Duster"..... 29.99 ea
MS348A	1970-72	"Duster 340"..... 29.99 ea
Window Decal		
DD400	1970-72	Duster cloud..... 4.99 ea



1971-72 Demon Decals

Reproduction decals for 1971-72 Demon models. These quality reflective decals will replace your faded original for a fresh appearance.

Fender Decals		
MS355	1971-72	"Demon"..... 19.99 ea
MS356	1971-72	"Demon 340"..... 19.99 ea
Deck Lid Decal		
MS357	1971-72	"340"..... 9.99 ea
Hood Decal		
MS358	1971-72	"Sizzler"..... 29.99 ea



1970 Challenger T/A Spoiler Decal

Reproduction "Challenger T/A" spoiler decal for 1970 T/A models. This decal is applied on the passenger side of the rear spoiler. MD4205 1970..... 11.99 ea

Western SPORT SPECIAL

1969-70 "Western Sport Special" Decal

Reproduction of the "Western Sport Special" decal mounted on the quarters of 1969 Dart and 1970 Challenger models. Manufactured in the correct script on original style reflective material. MD1650 1969-70..... 24.99 ea



1971-72 Scamp Decal

Reproduction "Scamp" fender decal for 1971-72 Plymouth Scamp models. This decal is applied on each fender as well as the trunk lid. MD4207 1971-72..... 7.99 ea



1973-74 Swinger Decal

Reproduction "Swinger" decal for all 1973-74 Dart Swinger models. This decal is applied to both fenders and the deck lid. Sold individually. MD4204 1973-74..... 9.99 ea



1971 GTX Deck Lid Decal

This red/reflective Plymouth GTX decal is applied on the right side of the deck lid of 1971 GTX models. Replace your damaged original with this quality reproduction for a showroom-new look. MS485 1971..... 29.99 ea



1976 "Dart Lite" Fender Decal

Reproduction "Dart Lite" fender decal for 1976 Dart models. Features the correct white center with black outline. MA1175 1976..... 14.99 ea



1968-70 Charger General Lee Decal Sets

Feel like a good ol' boy with these General Lee decals for 1968-70 Charger models. This complete set includes a Confederate flag and two "General Lee" names for the roof and two "01" door decals. General Lee font differs between the TV and Movie version.

Note: The only difference between the two sets is the font of the "General Lee" roof name. Complete Sets MS377 1968-70 movie version..... 299.99 set MS378 1968-70 TV version..... 299.99 set

Underhood Decals



MD906



MD893



MD907



MD908



MD915



MD932



MS434



MS436



MD933



MD877



MD881



MD882



MD884

1962-76 Air Cleaner Decals

Restore the air cleaner on your 1962-76 Dodge or Plymouth with this factory appearance with these high quality reproduction decals manufactured with correct colors in their same design as original.

Service Instructions

MD885	1962-64	413/426 2x4 carbs	4.99 ea
MD886	1963-65	all models	4.99 ea
MD887	1966-67	426 2-4V Hemi	4.99 ea
MD888	1966	318	4.99 ea
MD889	1966	Charger 361	4.99 ea
MD890	1966	383-4V	4.99 ea
MD891	1967	383-4V	4.99 ea
MD892	1969	Six-Pack	4.99 ea
MD893	1970-71	air cleaner instruction decal	4.99 ea
MD894	1970-71	fresh air hood scoop special instructions	4.99 ea
MD895	1971	w/non-fresh air hood	4.99 ea
MD896	1972-74	blue/black print	4.99 ea
MD897	1972-74	blue print	7.99 ea

Air Cleaner Lid

MD898	1964	426 Wedge 365 HP	4.99 ea
MD899	1964	Plym. 426 Stage III	4.99 ea
MD900	1968-71	340, 360 w/o snorkel	4.99 ea
MD900	1970-71	440 dual snorkel	4.99 ea
MD900	1972	340, 360 dual snorkel	4.99 ea
MD900	1972	400, 440-4V dual snorkel	4.99 ea
MD901	1964-67	Valiant, "Cuda Commando 273	11.99 ea
MD902	1965-69	Dart, "Charger" 273 4BBL	11.99 ea
MD903	1964-65	Plymouth Commando 426	11.99 ea
MD904	1966	Plymouth Sport Fury	4.99 ea
MD905	1967-71	361, 383, 440 single snorkel	6.99 ea
MD906	1963-69	Dodge, "Charger 225"	5.99 ea
MD907	1963-69	Plymouth, "Super 225"	5.99 ea
MD908	1966-67	426 HEMI (small)	6.99 ea
MD909	1968-70	426 HEMI HEAD (large)	9.99 ea
MD910	1966-70	Plymouth Super Commando 383	11.99 ea
MD911	1966-70	Plymouth Super Commando 440	11.99 ea
MD912	1966-70	Dodge Magnum 383 (red)	11.99 ea
MD913	1966-70	Dodge Magnum 383 (orange)	11.99 ea
MD914	1966-70	Dodge Magnum 440 (red)	11.99 ea
MD915	1966-70	Dodge Magnum 440 (orange)	11.99 ea
MD916	1966-70	340 Four Barrel (red)	11.99 ea
MD917	1966-71	340 Four Barrel (orange)	11.99 ea
MD918	1966-70	383 Four Barrel (red)	11.99 ea
MD919	1966-70	383 Four Barrel (orange)	11.99 ea
MD920	1966-68	440 Four Barrel (red)	11.99 ea
MD921	1966-71	440 Four Barrel (orange)	11.99 ea
MD922	1968-70	Road Runner 383	11.99 ea
MS434	1969	Road Runner - Coyote Duster	39.99 ea
MS436	1970	Road Runner - Coyote Duster	29.99 ea
MD923	1970-71	Plymouth 340 Six Barrel	6.99 ea
MD924	1970-71	Dodge 340 Six Pack	6.99 ea
MD925	1970-71	Plymouth 440 Six Barrel	6.99 ea
MD926	1970-71	Dodge Magnum 440 Six Pack	6.99 ea
MD927	1971	440 Six Pack	6.99 ea
MD928	1971	HEMI 426	6.99 ea
MD929	1972-74	340 Four Barrel	6.99 ea
MD930	1972-74	360 Four Barrel	6.99 ea
MD931	1972-74	400 Four Barrel	6.99 ea
MD932	1972-74	440 Four Barrel	6.99 ea
MD933	1975-76	360 Cubic Inches	4.99 ea
MD934	1975-76	400 Cubic Inches	4.99 ea

1962-74 Valve Cover Decals

Reproduction valve cover decals for various 1962-74 Dodge and Plymouth models. Valve cover decals feature correct lettering and colors as original.

Note: Two decals required per vehicle.

Dodge-"Ramcharger"

MD877	1963-66	426	6.99 ea
MD878	1963-64	426-A	6.99 ea
MD879	1964	II	6.99 ea
MD880	1964	III	6.99 ea

Plymouth-"Super Stock 426"

MD881	1963-64	stage I	6.99 ea
MD882	1964	stage II	6.99 ea
MD883	1964	stage III	6.99 ea
MD884	1962-74	"426 Hemi Powered 425 HP"	5.99 ea



1969 B-Body AIR GRABBER Decal

Reproduction AIR GRABBER decal for 1969 Plymouth B-Body models equipped with the N96 option. This decal is applied to the front of the under hood Air Grabber box.

MD4089 1969-70..... 7.99 ea



1969-70 B-Body RAMCHARGER Air Box Decal

Reproduction RAMCHARGER air box decal for 1969-70 Dodge B-Body models equipped with the N96 option. This decal is applied to the front of the under hood RAMCHARGER unit.

MD4090 1969-70..... 7.99 ea



1970-71 E-Body SHAKER Decal

Reproduction SHAKER decal for 1970-71 Barracuda and Challenger models. This decal is applied to the underside of the hood at the back of the shaker scoop opening for to give the appearance of shaking when the hood is opened with the engine running.

MD4088 1970-71..... 4.99 ea

Underhood Decals



IMPORTANT
180°F. Thermostat Must Be Removed
And 160°F. Thermostat Installed If
Alcohol Type Anti-Freeze is Used.

1960 Important Thermostat Decal

Thermostat decal for all 1960 Dodge and Plymouth models.

MD4072 1960..... 4.99 ea

IMPORTANT
Protects to 180°F. with MOPAR Permanent Antifreeze
(Ethylene Glycol Type) Only.
Checked by Dealer.

MD4071

IMPORTANT
Protects to 180°F. with MOPAR Permanent Antifreeze
(Ethylene Glycol Type) Only.
Checked by Dealer.

MD4076

1960-64 Important Antifreeze Decal

Reproduction important antifreeze decal for 1960-64 Dodge and Plymouth models. Features correct black, yellow and red colors.

MD4071 1960..... 4.99 ea

MD4076 1962-64..... 4.99 ea



USE MOPAR RUST RESISTOR
USE MOPAR ANTIFREEZE

REPLACE 180°F. WITH 160°F. THERMOSTAT
FOR ALCOHOL TYPE ANTIFREEZE

1960-64 Important Rust Resistor Decal

Reproduction rust resistor decal for all 1960-64 Dodge and Plymouth models. Features correct black, yellow and red colors.

MD4073 1960-64..... 4.99 ea



IMPORTANT
Protects to 180°F. with MOPAR Permanent Antifreeze
(Ethylene Glycol Type) Only.
Checked by Dealer.

MD4077

IMPORTANT
Protects to 180°F. with MOPAR Permanent Antifreeze
(Ethylene Glycol Type) Only.
Checked by Dealer.

RC11

1962-73 Important Rust Resistor Decal

Reproduction Mopar antifreeze decal for all 1962-73 Dodge and Plymouth models. Features correct black, yellow and red colors.

MD4077 1962-68 Mopar..... 4.99 ea

RC11 1969-73 Chrysler..... 8.99 ea



Use only 180° Thermostat!
Use Mopar antifreeze (Permanent type only).
Protect radiator to 187° for summer operation.

MD4074

1962-69 Mopar Warm Climate Decal

Reproduction Mopar warm climate decal for all 1962-69 Dodge and Plymouth models. Features correct black and yellow colors as original.

MD4074 1962-64..... 4.99 ea

MD4075 1965-69..... 3.99 ea



COOLANT RESERVE SYSTEM COOLANT ADDITIONS
MAINTAIN COOLANT LEVEL TO 20% BELOW TOP
BETWEEN MARK AND 50% MARKS AT NORMAL
WARM ENGINE OPERATING TEMPERATURE
(INDICATOR)
PROTECTED TO 200°F. BY 15W-40 MOTOR OILS AND POLICE
WITH MOPAR ANTIFREEZE (ETHYLENE GLYCOL TYPE)
CHECKED BY DEALER

MD4078

COOLANT RESERVE SYSTEM
COOLANT ADDITIONS
MAINTAIN COOLANT LEVEL TO 20% BELOW TOP
BETWEEN MARK AND 50% MARKS AT NORMAL
WARM ENGINE OPERATING TEMPERATURE
(INDICATOR)
PROTECTED TO 200°F. BY 15W-40 MOTOR OILS AND POLICE
WITH MOPAR ANTIFREEZE (ETHYLENE GLYCOL TYPE)
CHECKED BY DEALER

MD4079

COOLANT RESERVE SYSTEM
COOLANT ADDITIONS
MAINTAIN COOLANT LEVEL IN RESERVE
TANK BETWEEN 1 AND 3/4 MARK AT NORMAL
TEMPERATURE WITH 50-50 ANTIFREEZE
BLEEDING SYSTEM
REMOVE RADIATOR CAP AND FILL RADIATOR FULL

MD4080

1973-76 Coolant Reserve Decal

Reproduction coolant reserve decal for all 1973-76 Dodge and Plymouth models. Features correct white and green colors as original.

MD4078 1973-75..... 3.99 ea

MD4079 1975-76 5-1/2"..... 3.99 ea

MD4080 1975-76 3"..... 3.99 ea



IMPORTANT
PROTECTED TO 200°F. WITH MOPAR
PERMANENT ANTIFREEZE (ETHYLENE GLYCOL
TYPE) ONLY.
CHECKED BY DEALER

IMPORTANT
MAINTAIN COOLANT LEVEL AND
TEMPERATURE WITH MOPAR
ANTIFREEZE (ETHYLENE GLYCOL
TYPE) ONLY.
CHECKED BY DEALER

1976 Coolant Warning Decal

Reproduction coolant warning decal for all 1976 Dodge and Plymouth models. Features correct white, red, blue and black colors.

MD4081 1976..... 5.99 ea



1960-64 Fuel Filter Decal

Reproduction fuel filter decal for all 1960-64 Dodge and Plymouth models. This decal is applied on the body of the in-line fuel filter assembly.

MD4093 1960-64..... 4.99 ea



1960-64 Power Steering Pump Decal

Reproduction power steering pump decal for all 1960-64 Dodge and Plymouth models.

MD4091 1960-64..... 4.99 ea



1968-71 Alternator Inspection Decal

This decal is applied on the bottom portion of the alternator housing near the part number and date code stamping by the inspector at the factory.

Note: Inspector number will vary.

CA10 1968-71 all..... 6.99 ea



1970-71 Vacuum Advance Decal

This decal is applied on the front curved side of the vacuum advance module on 1970-71 models.

VA10 1970-71 all..... 6.99 ea



DRY CYCLE ADJUSTMENT
REMOVE SCREW - OPERATE
WASHER TO FLUSH. RE-
PLACE SCREW TO ORIGINAL
DRY CYCLE SETTING.

CAPACITY
60 FL. OZS.

MD191

1960-61 Windshield Washer Decals

Reproduction windshield washer decals for all 1960-61 Dodge and Plymouth models.

MD4187 1960-61 flush instructions.... 3.99 ea

MD4191 1960-61 washer capacity.... 3.99 ea



1960-64 Cruise Control Decal

Reproduction cruise control decal for all 1960-64 Dodge and Plymouth models. This decal is applied to the auto pilot cruise control unit housing, in the engine compartment.

MD4186 1960-64..... 4.99 ea



1960-65 Oil Filter Decal

Reproduction oil filter decal for all 1960-65 Dodge and Plymouth models with a spin on style oil filter.

MD4070 1960-65..... 4.99 ea

Underhood Decals

1968-76 Emission Decals



These decals were applied in various locations, most commonly on the driver's side inner fender. This decal denoted the engine tuning specifications, instructions and emission information (when applicable). These quality reproduction decals feature the original part number and correct color for an authentic appearance. Location of decal may vary depending on year and model of vehicle. OE numbers are for cross reference purposes only, use Classic Industries item numbers to order.



MDS16



MD823



1960-64 Voltage Regulator Tag

Reproduction voltage regulator decal for all 1960-64 Dodge and Plymouth models. This tag folds over and staples around the wire on the voltage regulator, stating where to connect wire.

MD4189 1960-64 4.99 ea



Item # OE # Engine Specs Price

1968 Manual Transmission			
MD800	2899844	383-2V	4.99 ea
MD803	2899844	225	4.99 ea
MD803	2899844	225	4.99 ea
MD803	2899844	383-4V	4.99 ea
MD805	2899846	426-8V	4.99 ea
MD806	2899847	318-2V	4.99 ea
MD808	2899978	273-2V	4.99 ea

1968 Automatic Transmission

MD801	2899842	340-4V	4.99 ea
MD801	2899842	383-4V	4.99 ea
MD801	2899842	440-4V	4.99 ea
MD802	2899843	273-2V	4.99 ea
MD802	2899846	426-8V	4.99 ea
MD807	2899977	318-2V	4.99 ea

1969 Manual Transmission

MD800	2899841	383-2V	4.99 ea
MD804	2899845	440-4V	4.99 ea
MD804	2899845	440-4V	4.99 ea
MD804	2899845	440+6	4.99 ea
MD805	2899846	340-4V	4.99 ea
MD808	2899978	273-2V	4.99 ea
MD811	2951367	426-8V	4.99 ea

1969 Automatic Transmission

MD801	2899842	383-4V	4.99 ea
MD801	2899842	440-4V	4.99 ea
MD803	2899844	225	4.99 ea
MD803	2899844	318-2V	4.99 ea
MD809	2946585	426-8V	4.99 ea
MD810	2951808	340-4V	4.99 ea
MD812	2951367	426-8V	4.99 ea
MD812	3412418	440+6	4.99 ea

1970 Manual Transmission

MD805	2899846	383-4V before 1/70	4.99 ea
MD805	2899846	318-2V before 1/70	4.99 ea
MD812	3412418	340-4V before 1/70	4.99 ea
MD812	3412418	440+6 before 1/70	4.99 ea
MD817	3462553	440-4V before 1/70	4.99 ea
MD819	3512031	426-8V before 1/70	4.99 ea
MD820	3557719	225 before 1/70	4.99 ea
MD823	3577705	318-2V after 1/70	4.99 ea
MD824	3577707	340-4V after 1/70	4.99 ea
MD825	3577708	383-4V after 1/70	4.99 ea
MD827	3577712	440-4V after 1/70	4.99 ea
MD828	3577713	440-4B after 1/70	4.99 ea
MD829	3577715	440+6-Body only after 1/70	4.99 ea
MD832	3577718	440+6 after 1/70	4.99 ea
MD835	3577729	340-6V after 1/70	4.99 ea

1970 Automatic Transmission

MD803	2899844	225 AT before 1/70	4.99 ea
MD804	2899845	318-2V before 1/70	4.99 ea
MD812	3412418	340-4V before 1/70	4.99 ea
MD812	3412418	440+6 before 1/70	4.99 ea
MD813	3462424	383-2V before 1/70	4.99 ea
MD814	3462438	383-4V before 1/70	4.99 ea
MD815	3462517	383-4V before 1/70	4.99 ea
MD816	3462552	440-4V before 1/70	4.99 ea
MD818	3513030	426-8V before 1/70	4.99 ea
MD821	3577703	225 AT after 1/70	4.99 ea
MD822	3577704	225 AT B-Body only after 1/70	4.99 ea
MD826	3577711	383-4V after 1/70	4.99 ea
MD829	3577715	440+6 E-Body only after 1/70	4.99 ea
MD830	3577716	426-8V after 1/70	4.99 ea
MD831	3577717	426-8V after 1/70	4.99 ea
MD832	3577718	440+6 after 1/70	4.99 ea
MD834	3577727	318-2V after 1/70	4.99 ea
MD836	3577730	340-6V after 1/70	4.99 ea

Item # OE # Engine Specs Price

1971 Manual Transmission			
MD840	3614865	340-4V late models	4.99 ea
MD841	3614872	383-4V	4.99 ea
MD843	3614875	440-4V	4.99 ea
MD845	3614877	440+6	4.99 ea
MD846	3614878	426-8V Hemi	4.99 ea

1971 Automatic Transmission

MD837	3414862	225	4.99 ea
MD839	3577732	340-4V early	4.99 ea
MD840	3614865	340-4V late models	4.99 ea
MD842	3614873	383-4V	4.99 ea
MD844	3614876	440-4V	4.99 ea
MD845	3614877	440+6	4.99 ea
MD847	3614879	426-8V Hemi	4.99 ea

1972 Manual Transmission

MD850	3671761	318-2V CA emission	4.99 ea
MD851	3698706	318	4.99 ea
MD852	3698707	340-4V	4.99 ea

1972 Automatic Transmission

MD849	3698702	225	4.99 ea
MD850	3671761	318-2V CA emission	4.99 ea
MD853	3698708	340-4V	4.99 ea
MD854	3698733	318	4.99 ea
MD855	3671764	340-4V before 1/72	4.99 ea
MD856	3698866	400-4V late models	5.99 ea

1973 Manual Transmission

MD857	3751308	225 AT/MT	4.99 ea
MD858	3751311	318 AT/MT	4.99 ea
MD859	3751312	340-4V MT	4.99 ea
MD861	3751315	400	5.99 ea
MD862	3751323	340 Air system	4.99 ea
MD863	3751338	340 Calif. air system	4.99 ea
MD864	3751349	Calif. window	5.99 ea

1973 Automatic Transmission

MD857	3751308	225	4.99 ea
MD858	3751311	318	4.99 ea
MD860	3751313	340-4V	4.99 ea
MD861	3751315	400	5.99 ea
MD862	3751323	340 Air system	4.99 ea
MD863	3751338	340 Calif. air system	4.99 ea
MD864	3751349	Calif. window	5.99 ea

1974 Manual Transmission

MD865	3830257	318	4.99 ea
MD866	3830259	360	4.99 ea
MD867	3830262	400	5.99 ea
MD868	3830266	318	4.99 ea

1974 Automatic Transmission

MD865	3830257	318	4.99 ea
MD866	3830259	360	4.99 ea
MD867	3830262	400	5.99 ea
MD868	3830266	318	4.99 ea

1975 Manual Transmission

MD873	4027041	225 AT/MT	6.99 ea
-------	---------	-----------	---------

1975 Automatic Transmission

MD869	4041301	225 Vacuum hose routing decal	6.99 ea
MD870	4071779	225-1V Vacuum hose routing decal	6.99 ea
MD871	4006954	360-4V Vacuum hose routing decal	6.99 ea
MD872	4027030	440-4V Vacuum hose routing decal	4.99 ea

1976 Manual Transmission

MD875	4041169	318 AT/MT	5.99 ea
-------	---------	-----------	---------

1976 Automatic Transmission

MD874	4041198	225	5.99 ea
MD875	4041169	318	5.99 ea
MD876	4100522	318-2V Vacuum hose routing decal	6.99 ea



1971-76 Electronic Ignition Decal

Reproduction electronic ignition decal for all 1971-76 Dodge and Plymouth models. This decal is applied on the electronic ignition control box, which is usually mounted to the firewall.

MD4094 1971-76 4.99 ea



1962-67 Super Stock Battery Decal

Reproduction of the trunk mounted super stock battery decal for all 1962-67 Dodge and Plymouth models. This decal is applied on the side of the trunk mounted Mopar battery which came in super stock cars.

MD4095 1962-67 5.99 ea



1960-64 Battery Decal

Reproduction group 27 battery decal for all 1960-64 Dodge and Plymouth models.

MD4181 1960-64 4.99 ea

Underhood Decals/Tags



BOOSTER OR BATTERY NEG. (-) CABLE MUST GO TO NEG. (-) POS. (+) TO POS. (+) DISCONNECT BATTERY CABLES BEFORE USING CHARGER.

MD4082

CAUTION
BOOSTER OR BATTERY NEG. (-) CABLE MUST GO TO NEG. (-) POS. (+) TO POS. (+) DISCONNECT BATTERY CABLES BEFORE USING CHARGER.

MD4083

1960-68 Battery Warning Decal

Reproduction battery warning decal for all 1960-68 Dodge and Plymouth models. Features correct red and black colors as original.

MD4082 1960-61 4.99 ea
MD4083 1962-68 4.99 ea



MD4174



MD4175

1960-73 Airtemp Decal

Reproduction Airtemp air conditioning window decal for all 1960-73 Dodge and Plymouth models. This decal was usually applied on the right hand quarter window in the forward lower corner

MD4174 1960-65 4.99 ea
MD4175 1966-73 4.99 ea



1968-75 AC Charge Decal

Reproduction air conditioner charge decal for all 1968-75 Dodge and Plymouth models.

MD4187 1968-75 4.99 ea



1973 AC Compressor Decal

Reproduction AC compressor decal for all 1973 Dodge and Plymouth models. Mounts between the cylinders on the air conditioning compressor.

MD4188 1973 4.99 ea



S 25356	2802 648	96555 N
2770 414	96555 N	2802 710
S 25356	2802 648	96555 N
2770 414	96555 N	2802 710
S 25356	2802 648	96555 N
2770 414	96555 N	2802 710
S 25356	2802 648	96555 N
2770 414	96555 N	2802 710
S 25356	2802 648	96555 N
2770 414	96555 N	2802 710

BP10

BP22

BP24

1966-71 Positive Battery Cable Tags

Replacement positive battery cable tags for various 1966-71 models. Positive battery cable tags are located where the wrap starts near the terminal head, but some were positioned at the tape wrap/sheathing, near the ground end of the cable.

Manual

A-Body Models		
BP14 1968	426 Hemi	7.99 ea
B-Body Models		
BP10 1966	426 Hemi	7.99 ea
BP12 1967	426 Hemi	7.99 ea
BP14 1968	426 Hemi	7.99 ea
BP18 1969	383	7.99 ea
BP18 1969	440-4 bbl.	7.99 ea
BP18 1969	440-6 bbl.	7.99 ea
BP16 1969	426 Hemi	7.99 ea
BP19 1970	383 & 440	7.99 ea
BP19 1970	440-6 bbl.	7.99 ea
BP20 1970	426 Hemi	7.99 ea
BP26 1971	383 & 440 - 6 pack	7.99 ea
BP28 1971	426 Hemi	7.99 ea

E-Body Models		
BP22 1970	340-4 bbl.	7.99 ea
BP22 1970	340-6 bbl.	7.99 ea
BP23 1970	383	7.99 ea
BP23 1970	440-4 bbl.	7.99 ea
BP23 1970	440-6 bbl.	7.99 ea
BP24 1970	426 Hemi	7.99 ea
BP27 1971	340-4 bbl.	7.99 ea
BP28 1971	383	7.99 ea
BP28 1971	440-4 bbl.	7.99 ea
BP28 1971	440-6 bbl.	7.99 ea
BP29 1971	426 Hemi	7.99 ea

Automatic

A-Body Models		
BP15 1968	426 Hemi	7.99 ea
B-Body Models		
BP11 1966	426 Hemi	7.99 ea
BP13 1967	426 Hemi	7.99 ea
BP15 1968	426 Hemi	7.99 ea
BP18 1969	383	7.99 ea
BP18 1969	440-4 bbl.	7.99 ea
BP18 1969	440-6 bbl.	7.99 ea
BP17 1969	426 Hemi	7.99 ea
BP19 1970	383 & 440	7.99 ea
BP19 1970	440-6 bbl.	7.99 ea
BP21 1970	426 Hemi	7.99 ea
BP30 1971	426 Hemi	7.99 ea

E-Body Models		
BP22 1970	340-4 bbl.	7.99 ea
BP22 1970	340-6 bbl.	7.99 ea
BP23 1970	383	7.99 ea
BP23 1970	440-4 bbl.	7.99 ea
BP23 1970	440-6 bbl.	7.99 ea
BP23 1970	426 Hemi	7.99 ea
BP27 1971	340-4 bbl.	7.99 ea
BP28 1971	383	7.99 ea
BP28 1971	440-4 bbl.	7.99 ea
BP28 1971	440-6 bbl.	7.99 ea
BP30 1971	426 Hemi	7.99 ea



96555 N	2802 770	96555 N
2770 423	96555 N	2802 770
96555 N	2802 770	96555 N
2770 423	96555 N	2802 770
96555 N	2802 770	96555 N
2770 423	96555 N	2802 770
96555 N	2802 770	96555 N
2770 423	96555 N	2802 770
96555 N	2802 770	96555 N
2770 423	96555 N	2802 770

BN10

BN11

BN12

1966-71 Negative Battery Cable Tags

Replacement negative battery cable tags for various 1966-71 models. The tag is located on the cable approximately 3-5 inches down from the terminal head.

Manual

A-Body Models		
BN10 1968	426 Hemi	7.99 ea
B-Body Models		
BN10 1966-69	426 Hemi	7.99 ea
BN11 1970-71	383 & 440	7.99 ea
BN12 1970-71	440-6 bbl.	7.99 ea
BN12 1970-71	426 Hemi	7.99 ea

E-Body Models		
BN11 1970-71	383 & 440	7.99 ea
BN11 1970-71	440-6 bbl.	7.99 ea
BN12 1970-71	426 Hemi	7.99 ea

Automatic

A-Body Models		
BN10 1968	426 Hemi	7.99 ea
B-Body Models		
BN10 1968	426 Hemi	7.99 ea
BN10 1966-69	426 Hemi	7.99 ea
BN11 1970-71	383 & 440	7.99 ea
BN11 1970-71	440-6 bbl.	7.99 ea
BN12 1970-71	426 Hemi	7.99 ea
E-Body Models		
BN11 1970-71	383 & 440	7.99 ea
BN11 1970-71	440-6 bbl.	7.99 ea
BN12 1970-71	426 Hemi	7.99 ea



25797	2631	2983
	828	706
2631	25797	25797
828	25797	2983
25797	2631	2983
	828	706
2631	25797	25797

FZ10

FZ13

FZ14

1968-71 Fusible Link Wire Tag

Replacement fusible link wire tag for 1968-71 models. This tag is installed approximately an inch from the end of the wire that plugs into the headlamp harness.

B-Body Models		
FZ10 1968	w/o 60 & 65 amp alt.	7.99 ea
FZ11 1969	w/o 60 & 65 amp alt.	7.99 ea
FZ12 1969	w/60 & 65 amp alt.	7.99 ea
FZ13 1970	w/60 & 65 amp alt.	7.99 ea
FZ15 1971	w/60 & 65 amp alt.	7.99 ea
E-Body Models		
FZ14 1970	all	7.99 ea

Reproduction Decals/Tags



2406 627	3513 636	55062
55062	55062	2983 815
2406 627	3513 636	55062
55062	55062	2983 815
2406 627	3513 636	55062
55062	55062	2983 815
2406 627	3513 636	55062
55062	55062	2983 815

FT10 FT11 FT16

1968-71 Fender Mounted Turn Signal Wire Tags

Replacement wire tags for 1968-71 vehicles equipped with fender mounted turn signals. The tags are located approximately 2 inches down the wire from the bulb socket. Sold in pairs.

B-Body Models

FT10 1968	Belvedere, Satellite	9.99 pr
FT12 1969	Belvedere, Satellite	9.99 pr
FT14 1970	Belvedere, Satellite	9.99 pr
FT18 1971	Belvedere, Satellite	9.99 pr
FT10 1968	Coronet	9.99 pr
FT11 1968	Charger	9.99 pr
FT12 1969	Coronet	9.99 pr
FT13 1969	Charger, R/T	9.99 pr
FT14 1970	Coronet	9.99 pr
FT15 1970	Charger, R/T	9.99 pr
FT18 1971	Coronet	9.99 pr
FT19 1971	Charger, R/T	9.99 pr

E-Body Models

FT17 1970	w/340	9.99 pr
FT16 1970	all exc. 340	9.99 pr
FT200 1971	all	9.99 pr



96555 C	2926 087	78352	2983 718
2926 088	78352	96555 C	
96555 C	2926 087	78352	2983 718
		96555 C	

NR16 NR11 NR16

1968-71 Neutral Safety & Reverse Switch Harness Tag

Replacement neutral safety and reverse switch harness tag for various 1968-71 models. The tag is located approximately 6 inches from where the harness connector plugs into the switch. Available for manual and automatic transmissions.

B-Body

NR10 1968	manual	6.99 ea
NR11 1968	automatic	6.99 ea
NR12 1969	manual	6.99 ea
NR13 1969	automatic	6.99 ea
NR14 1970	manual	6.99 ea
NR15 1970	automatic	6.99 ea
NR18 1971	manual	6.99 ea
NR19 1971	automatic	6.99 ea

E-Body

NR16 1970	manual	6.99 ea
NR17 1970	automatic	6.99 ea
NR20 1971	manual	6.99 ea
NR21 1971	automatic	6.99 ea



1970-71 Fog Lamp (Road Lamp) Wire Decal

Replacement fog lamp notice decal for 1970-71 Barracuda models. This decal is located on the wire, approximately 10 to 12 inches down from where it exits the firewall.

FL10 1970-71	Barracuda	11.99 pr
--------------	-----------	----------

45

BB10

46

BB11

1971 Power Brake Booster Decal

Replacement power brake booster decal for all 1971 models. This decal is applied to the top, front side area of the brake booster.

BB10 1971	340, 383 & 440	6.99 ea
BB11 1971	426	6.99 ea

1969 Plymouth Master

Cylinder Tag

Reproduction disc brake master cylinder tag for 1969 Plymouth Road Runner, GTX and Satellite models.

This is the small tag that came attached to the disc brake master cylinder.

MD4092 1969	5.99 ea
-------------	---------



TS10



TS11



TS13

1968-71 Turn Signal Switch Harness Tag

Replacement turn signal switch harness tag for various 1968-71 models. This tag is located near the center area of the harness that is routed the length of the steering column.

B-Body Models

TS10 1968	all	6.99 ea
TS11 1969	all	6.99 ea
TS12 1970	w/knob	6.99 ea
TS14 1971	w/o tilt steering	6.99 ea
TS15 1971	w/tilt steering	6.99 ea

E-Body Models

TS13 1970	w/knob	6.99 ea
TS16 1971	all	6.99 ea



1968-71 Engine Break-In Tag

Reproduction engine break-in instructions tag for all 1968-71 Dodge and Plymouth models.

MD4199 1968-71	4.99 ea
----------------	---------

1970-73 Engine Starting Tag Decal

Reproduction engine starting tag for all 1970-73 Dodge and Plymouth models. This tag was hung on to either the windshield wiper switch or on the steering column shift lever and offered the owner hot and cold starting instructions.

MD4171 1970-73	5.99 ea
----------------	---------



1971-74 Key Removal Decal

Reproduction key removal lever decal for all 1971-74 Dodge and Plymouth models. This decal is applied on the safety lever that must be held down to take the key out of the ignition.

MD4172 1971-74	4.99 ea
----------------	---------



1960-67 Glove Box I.D. Decal

Reproduction of the glove box owners identification decal for all 1960-67 Dodge and Plymouth models.

MD4180 1960-67	4.99 ea
----------------	---------



1962-65 426 "Sold As Is" Glove Box Decal

"Sold As Is" decal for all 1962-65 Dodge and Plymouth models equipped with a 426 cubic inch engine. Applied inside the glove box of any Hemi powered car.

MD4170 1962-65	3.99 ea
----------------	---------

Reproduction Decals



MD4194



MD4193

1968-71 Seat Belt Instruction Tag

Reproduction seat belt usage instruction tag for all 1968-71 Dodge and Plymouth models.

- MD4194 1960-66 5.99 ea
- MD4193 1968-71 4.99 ea



1974 Seat Belt Interlock Decal

Reproduction seat belt interlock and reminder system decal for all 1974 Dodge and Plymouth models. This decal is applied to the drivers side sun visor and is manufactured with correct adhesive backed cloth as original.

- MD4195 1974 5.99 ea



MD4177



MD4178



MD4179

1968-70 Door Post Decal

Reproduction door post decal for all 1968-70 Dodge and Plymouth models. This decal was typically applied vertically on the driver's side door jamb. 1968 Super Stock cars used a different decal which states that the vehicle does not meet U.S. safety standards. This decal was applied on the driver side A pillar, readable from the inside of the vehicle.

- MD4177 1968 all models 4.99 ea
- MD4178 1968 Super Stock models.. 4.99 ea
- MD4179 1969-70 all models 4.99 ea



MD4085

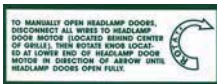

MD4086

1970-72 Charger Headlamp Rotation Decal

Reproduction of the hidden headlamp rotation decal for 1970-72 Dodge Charger models. Features correct green, yellow and black colors as original.

- MD4085 1970 4.99 ea
- MD4086 1971-72 4.99 ea



1962-65 Max Wedge Shipping Decal

Reproduction Max Wedge windshield shipping decal for all 1962-65 B-Body models equipped with a 426 engine. This decal was applied on the front windshield and gave the transporter shipping instructions.

- MD4190 1962-65 4.99 ea



1971 Satellite Car Of The Year Decal

Reproduction car of the year decal for 1971 Plymouth Satellite models.

- MD4173 1971 6.99 ea



1966-70 Dealer Accessory Window Card

Reproduction dealer accessory window card for all 1966-70 Dodge and Plymouth models. This card was attached to the window and listed dealer added accessories.

- MD4202 1966-70 4.99 ea



MD4196

MD4201

1964-71 Vehicle Warranty Information

Reproduction new vehicle warranty cards and folders for Dodge and Plymouth models. These cards were applied next to the new car window sticker offering information on the warranty, while the warranty folders themselves were in the glove box with the owner's manual.

- MD4196 1964 warranty card 4.99 ea
- MD4197 1965 warranty card 4.99 ea
- MD4200 1970 warranty folder 4.99 ea
- MD4201 1971 warranty folder 4.99 ea



1969 Dart GTS Warranty Supplement Sheet

Reproduction warranty supplement sheet for 1969 Dart GTS 440 models. Since this was a high performance car, the warranty was altered and this document outlined those changes.

- MD4198 1969 4.99 ea

1960-61 Plymouth Service Policy Booklet

Reproduction new vehicle service policy booklet for all 1960-61 Plymouth models. This booklet was included in the glove box and provided service information.

- MD4203 1960-61 4.99 ea

Reproduction Decals

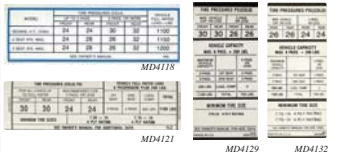

1966-76 Reproduction Tire Pressure Decals

Reproduction tire pressure decal for various 1966-76 Dodge and Plymouth models. This decal offered different specification details, based on tire size, body style, or engine size. This decal is commonly applied on the drivers side door jamb on the end of the quarter panel below the striker. The OE# column specifies the original code or part number on the decal.

A-Body	Year	OE#	Engine Specifications	Price
MD4100	1967	VL	Barracuda/Dart	4.99 ea
MD4101	1967	VC	Valiant	4.99 ea
MD4102	1967	BX-29	Barracuda	4.99 ea
MD4103	1968	VL	early Cuda/Dart/Valiant	4.99 ea
MD4104	1968	2948064	early models w/D70 x 14	4.99 ea
MD4105	1968	2948068	late models w/D70 x 14	4.99 ea
MD4106	1969	3400476	340 models w/D70 x 14	4.99 ea
MD4107	1969	3400494	all with 700 x 13 and 695 x 14 tires	4.99 ea
MD4108	1970-71	3402054	Twister	4.99 ea
MD4109	1970-72	3402055	340 models with E70 x 14 tires	4.99 ea
MD4110	1970	3402056	Dart 340 w/E70 x 14 tires	4.99 ea
MD4111	1970	3402057	all with E78 x 14 tires	4.99 ea
MD4112	1970	3402181	all w/695 x 14 and C78 x 14 tires	4.99 ea
MD4113	1971	3402334	all w/695 x 14 tires	4.99 ea
MD4114	1971-73	3402339	Swinger w/695 x 14 tires	4.99 ea
MD4115	1973-75	3815046	all with 735 x 14 tires	4.99 ea
MD4116	1974	3845103	Duster with 695 x 14 tires	4.99 ea
MD4117	1975-76	3845384	Dart/Duster with D78 x 14 tires	4.99 ea
B-Body	Year	OE#	Engine Specifications	Price
MD4118	1966	RW	all	4.99 ea
MD4102	1967	BX-29	Charger	4.99 ea
MD4119	1967	RV	Belvedere/Coronet	4.99 ea
MD4120	1968	RW-W29	Belvedere/Coronet	4.99 ea
MD4121	1968	2948052	Charger	4.99 ea
MD4122	1968	2948053	all late models w/775 x 14/775 x 15	4.99 ea
MD4123	1968	54	Road Runner w/F70 x 14	4.99 ea
MD4124	1968	2948055	late Hemi w/F70 x 15	4.99 ea
MD4125	1969	3400452	all w/735 x 14/775 x 15	4.99 ea
MD4126	1969	3400453	383/440 w/775 x 14 and 775 x 15	4.99 ea
B-Body	Year	OE#	Engine Specifications	Price
MD4127	1969	3400454	383/440 w/F70 x 14	4.99 ea
MD4128	1969	3402163	with G70 x 14 tires	4.99 ea
MD4129	1969	3400455	AT Hemi w/F70 x 15 tires	4.99 ea
MD4130	1969	3400477	all with F70 x 14 tires	4.99 ea
MD4131	1969	3400478	Charger w/air w/775 x 14/775 x 15	4.99 ea
MD4132	1969	3400481	Charger w/o air w/775 x 14/775 x 15	4.99 ea
MD4133	1969	3400485	all with E70 x 14 tires	4.99 ea
MD4134	1969	3400486	all with F70 x 14 tires w/air	4.99 ea
MD4135	1969	3400487	all Hemi MT with F70 x 15 tires	4.99 ea
MD4136	1969	3402105	Daytona w/F70 x 14 tires	4.99 ea
MD4137	1970	3402067	Charger w/F78 x 14 tires	4.99 ea
MD4138	1970	3402068	383/440 models w/F70 x 14 tires	4.99 ea
MD4139	1971-73	3402195	Charger SE w/G78 x 14 tires	4.99 ea
MD4140	1971	3402336	all with F70 x 14 tires	4.99 ea
MD4141	1973	3402322	Road Runner	4.99 ea
MD4142	1974	3845107	Satellite w/F78 x 14 tires	4.99 ea
E-Body	Year	OE#	Engine Specifications	Price
MD4143	1970	3402059	440+6 models w/E60 x 15 tires	4.99 ea
MD4144	1970	3402067	Challenger convertible	4.99 ea
MD4145	1970	3402062	all w/F70 x 14 w/o air	4.99 ea
MD4146	1970	3402064	Hemi models w/F60 x 15 tires	4.99 ea
MD4147	1970	3402098	AAR/Challenger TA	4.99 ea
MD4148	1971	3402317	convertible w/735 x 14 tires	4.99 ea
MD4149	1971-74	3402318	hardtop with 735 x 14 tires	4.99 ea
MD4150	1971	3402330	Hemi with F60 x 15 tires	4.99 ea
MD4151	1971-74	3402331	hardtop with F70 x 14 tires	4.99 ea
MD4152	1971	3402335	hardtop with F78 x 14 tires	4.99 ea
MD4153	1974	3815047	all with F70 x w/14 tires	4.99 ea



MA2200 MB2076 ME3001 ME3002

1963-76 Reproduction Jack Instruction Decals

Reproduction jack instructions decal for various 1963-76 models. Features correct peel and stick backing for easy application. For best results, be sure to clean the area thoroughly of dirt before applying the decal. Choose from the different applications listed below.

A-Body	Year	Model	Price
MA2200	1963-64	Valiant/Dart	4.99 ea
MA2201	1965-66	Dart	4.99 ea
MA2202	1965	Valiant	4.99 ea
MA2203	1966-67	all models	4.99 ea
MA2204	1968-69	Dart	4.99 ea
MA2205	1970-71	all models	4.99 ea
MA2206	1972	Valiant/Dart	4.99 ea
MA2207	1973-74	Valiant/Dart	4.99 ea
MA2208	1974-75	Duster	4.99 ea
MA2209	1976	Valiant/Dart	4.99 ea
B-Body	Year	Model	Price
MB2072	1965	Belvedere/Coronet	4.99 ea
MB2073	1966	Belvedere/Coronet	4.99 ea
MB2074	1967	all models	4.99 ea
MB2075	1968	Belvedere/Coronet	4.99 ea
MB2076	1968	Charger	4.99 ea
B-Body	Year	Model	Price
MB2077	1969	Belvedere/Coronet	4.99 ea
MB2078	1969	Charger	4.99 ea
MB2079	1969	Daytona	4.99 ea
MB2080	1970	Belvedere/Coronet	4.99 ea
MB2081	1970	Charger	4.99 ea
MB2082	1970	Superbird	4.99 ea
MB2083	1971	all models	4.99 ea
MB2084	1972	Satellite/Road Runner	4.99 ea
MB2085	1972	Charger	4.99 ea
MB2086	1973	Satellite/Road Runner	4.99 ea
MB2087	1973	Charger	4.99 ea
MB2088	1974	Charger	4.99 ea
E-Body	Year	Model	Price
ME3000	1970	all	4.99 ea
ME3001	1971	all	4.99 ea
ME3002	1972-74	all	4.99 ea



UNLEADED GASOLINE ONLY



Unleaded Fuel Only Decal

Reproduction "unleaded fuel only" decals which are applied to the gas cap or gas tank fuel door.

Decal	Description	Price
"Unleaded Gasoline Only"		
DZ8	5" straight white	4.99 ea
DZ9	5" straight black	4.99 ea
DZ13	5" straight black and white	4.99 ea
"Unleaded Fuel Only"		
DZ10	3" curved white	4.99 ea
DZ11	3" curved black	4.99 ea
DZ12	4" straight black and silver	4.99 ea

We Have More to Offer!



Check out all the great catalogs Classic Industries® has to offer.

CAMARO
FIFTH GEN CAMARO
FIREBIRD/TRANS AM
CHEVY II/NOVA
TRI-FIVE CHEVROLET
IMPALA/FULL SIZE
CHEVY/GMC TRUCKS
MOPAR

FREE catalog of your choice for you or a friend.

Simply fill out the postcard, affix proper postage, and mail it to receive your FREE* printed catalog.

*Some restrictions apply. Visit www.classicindustries.com/info for additional information.

Free Catalog or CD ROM
888-46-CATALOG
(888-462-2825)

Free Catalog Offer for You or a Friend

Choose Your Free Catalog:

PRINTED CATALOG

- 1967-02 Camaro
- 2010-up Fifth Gen Camaro
- 1967-02 Firebird/Trans Am
- 1962-79 Chevy II/Novo
- 1955-57 "Tri-Five" Chevrolet
- 1958-96 Impala/Full Size Chevrolet
- 1947-08 Chevy/GMC Truck
- 1960-76 Mopar

CD-ROM CATALOG

- Includes All Catalogs on CD-ROM

My Address (please print):

Name _____
Address _____
City _____
State _____ ZIP Code _____
Email _____

Send a Catalog to a Friend:

PRINTED CATALOG

- 1967-02 Camaro
- 2010-up Fifth Gen Camaro
- 1967-02 Firebird/Trans Am
- 1962-79 Chevy II/Novo
- 1955-57 "Tri-Five" Chevrolet
- 1958-96 Impala/Full Size Chevrolet
- 1947-08 Chevy/GMC Truck
- 1960-76 Mopar

CD-ROM CATALOG

- Includes All Catalogs on CD-ROM

My Friend's Address (please print):

Name _____
Address _____
City _____
State _____ ZIP Code _____
Email _____

Free printed catalog offer valid for U.S. customers only. Limit one free printed catalog per address.

Important: Due to the uncertainty of our catalogs reaching the proper subscriber along with size and weight restrictions that vary from each individual facility, our free catalog offer does not apply to correctional facilities, government offices or any other institutional address where there are specific mail restrictions. Your cooperation and understanding are appreciated.

FREE
CATALOG

Special Offer!

3 Ways to Receive Your FREE Catalog



1 Printed Catalog

Fill Out & Mail The Postcard (affix proper postage)

To receive your FREE* printed catalog or call toll free 888-46-CATALOGS (888-462-2825)

*Some restrictions apply. Visit www.classicindustries.com/info for additional information.

2 CD Catalog

Fill Out & Mail the Postcard

(affix proper postage)

To receive your FREE CD catalog.

3 Download a Catalog

Visit Us On-line at

www.classicindustries.com

To download a FREE catalog.

Return Address

PLACE
STAMP
HERE

Classic
INDUSTRIES
Parts & Accessories

18460 Gothard St.
Huntington Beach, CA 92648-1229

Reproduction Decals



E.C.S.

1970 California Emissions Decal

Replacement fuel cap decal for all 1970 models equipped with California emissions. This decal is applied to the top flat portion of the gas cap below the twist lever grip bar.

CE10 1970 all 6.99 ea



CAUTION
FOLLOW JACKING
INSTRUCTIONS

MD4097

1962-70 Jack Base Decal

Reproduction jack base decal for various 1962-70 Dodge and Plymouth models. This decal is applied on the flat area of the top of the base plate and is readable from the front of the jack.

MD4096 1962-69 all 3.99 ea
MD4097 1968-70 Charger 4.99 ea
MD4097 1970 Barracuda/Challenger 4.99 ea



JACKING INSTRUCTIONS
SURE-GRIP DIFFERENTIAL

1964-71 Sure-Grip Warning Decal

Reproduction Sure-Grip differential warning decal for all 1964-71 models equipped with a limited-slip differential. This decal warns you not to start the vehicle if one of the rear wheels is still on the ground.

MD935 1964-71 4.99 ea



1970-71 Spare Tire Inflator Bottle Decal

Replace your missing space saver tire inflator bottle with this quality reproduction decal for 1970-71 models. Features correct colors and appearance.

MD937 1970-71 4.99 ea



MD936

1970-74 Space Saver Tire Decal

Reproduction space saver tire decal for 1970-74 models. This decal is applied to the spare tire's rim, centered with the valve stem. Available for models equipped with the BF Goodrich spare or the Goodyear spare.

MD936 1970-74 Goodyear spare 4.99 ea
MD4098 1970-74 Goodyear spare 4.99 ea



MD4182



MD4183



MD4185

1967-71 Convertible Caution Decal

Reproduction convertible caution decal for all 1967-71 Dodge and Plymouth models. This decal is applied on the convertible top header panel above the sun visors.

MD4182 1967 4.99 ea
MD4183 1968 4.99 ea
MD4184 1969 4.99 ea
MD4185 1970-71 4.99 ea



CAUTION: DO NOT
USE TIRE CHAINS!

1970-74 Space Saver Chain Warning Decal

Reproduction space saver chain warning decal for all 1970-74 Dodge and Plymouth models. This decal is applied on the inward part of the spare wheel.

MD4099 1970-74 4.99 ea



MD4158

MD4164

1960-75 New Vehicle Price Label

Reproduction window price label for various 1960-75 Dodge and Plymouth models. This label is applied on the side window. The decal is sold blank and will have to be filled out.

MD4154 1960 all Plymouth 4.99 ea
MD4155 1960 Valiant 4.99 ea
MD4156 1961 all Plymouth 4.99 ea
MD4157 1961 Valiant 4.99 ea
MD4158 1963 all early models 4.99 ea
MD4159 1963 all late models 4.99 ea
MD4160 1964-65 all models 4.99 ea
MD4161 1966 all Plymouth 4.99 ea
MD4162 1967 all Plymouth 4.99 ea
MD4163 1968 all Plymouth 4.99 ea
MD4164 1968 all Dodge 4.99 ea
MD4165 1970-73 all Dodge 4.99 ea
MD4166 1970-71 all Plymouth 4.99 ea
MD4192 1972-73 all Plymouth 4.99 ea
MD4167 1974 all Plymouth 4.99 ea
MD4168 1974-75 all Dodge 4.99 ea
MD4169 1975 all Plymouth 4.99 ea



EB13

1970-71 Emergency Brake Cable Tags

These tags are located approximately 12 to 14 inches down the cable from where the brake cable exits the drum backing plate. Sold in pairs.

Note: There is no conclusive evidence to determine whether or not 1970 vehicles came from the factory with these cable tags in place. The tags were on the cables that were sold by Chrysler (factory/service replacements) in the early 1970's.

B-Body Models

EB10 1970 318/383 w/std brakes 10.99 pr
EB11 1970 318/383 w/H/D brakes 10.99 pr
EB12 1970 383 w/o disc brakes 10.99 pr
EB13 1970 383 w/disc brakes 10.99 pr
EB14 1970 440/426 w/o disc brakes 10.99 pr
EB15 1970 440/426 w/disc brakes 10.99 pr
EB20 1971 w/H/D & w/o disc brakes 10.99 pr
EB21 1971 w/std disc brakes 10.99 pr

E-Body Models

EB16 1970 318/383 w/std brakes 10.99 pr
EB17 1970 318/383 w/H/D brakes 10.99 pr
EB18 1970 w/o disc brakes 10.99 pr
EB19 1970 w/disc brakes 10.99 pr
EB22 1971 w/H/D & w/o disc brakes 10.99 pr
EB23 1971 w/std disc brakes 10.99 pr



2931596 2931596 2931596 2931596

DX10

2931597 2931597 2931597 2931597

DX11

2931644 2931644 2931644 2931644

DX12

3432079 3432079 3432079 3432079

DX14

1969-71 Dana Axle Identification Decals

This decal is applied to the axle housing tube of Dana-axle equipped vehicles. It is positioned on the drivers side, inside the leaf spring U-bolts and wraps around the axle tube. Replace this often-missing decal with this factory-style replacement.

B-Body Models

Axles with 3.54 Ratio Gears
DX11 1969 10" power brakes 9.99 ea
DX10 1969 11" power brakes 9.99 ea
DX10 1969 w/manual brakes 9.99 ea
DX17 1970 w/manual drums 9.99 ea
DX18 1970 w/power brakes 9.99 ea
DX23 1971 w/manual brakes 9.99 ea
DX24 1971 w/power brakes 9.99 ea

Axles with 4.10 Ratio Gears

DX12 1969 w/power brakes 9.99 ea
DX13 1969 w/A12 package 9.99 ea
DX19 1970 all 9.99 ea
DX25 1971 all 9.99 ea

E-Body Models

Axles with 3.54 Ratio Gears
DX14 1970 w/power brakes 9.99 ea
DX15 1970 w/manual brakes 9.99 ea
DX20 1971 w/manual brakes 9.99 ea
DX21 1971 w/manual brakes 9.99 ea
Axles with 4.10 Ratio Gears
DX16 1970 all 9.99 ea
DX22 1971 all 9.99 ea

Reproduction Window Decals



Mopar Decal

Adhesive backed and applied from the outside of the window.

DD98	3-1/4"	4.99 ea
DD99	4"	4.99 ea
DD100	6-1/2"	5.99 ea



Chrysler Parts Decal

Adhesive backed and applied from the outside of the window.

DD141	4" x 3-1/8"	4.99 ea
-------	-------------	---------



Late 60s-80s Direct Connection Decal

Adhesive backed and applied from the outside of the window.

DD634	3-1/8" x 1-5/8"	4.99 ea
-------	-----------------	---------



Direct Connection Decal

Adhesive backed and applied from the outside of the window.

DD635	10-1/4" x 3-1/2"	6.99 ea
-------	------------------	---------



Direct Connected Decal

Adhesive backed and applied from the outside of the window.

DD115	10" x 3-1/2"	5.99 ea
-------	--------------	---------



Stage IV Direct Connection Decal

Adhesive backed and applied from the outside of the window.

DD126	4-1/4" x 1-3/4"	4.99 ea
-------	-----------------	---------



W-2 Direct Connection Decal

Adhesive backed and applied from the outside of the window.

DD127	5-1/2" x 1-3/4"	4.99 ea
-------	-----------------	---------



Direct Connection Special Parts Decal

Adhesive backed and applied from the outside of the window.

DD138	5-1/2"	4.99 ea
-------	--------	---------



Mighty Mopar Performance Parts Decal

Adhesive backed and applied from the outside of the window.

DD139	5-1/2"	4.99 ea
-------	--------	---------



Powered By Dodge Genuine Parts Decal

Adhesive backed and applied from the outside of the window.

DZ200	5-1/8" x 2-3/8"	4.99 ea
-------	-----------------	---------



Genuine Dodge Parts Decal

Adhesive backed and applied from the outside of the window.

DZ246	2-3/4" x 1-3/4"	4.99 ea
-------	-----------------	---------



White Bear Dodge Decal

Adhesive backed and applied from the outside of the window.

DZ206	3-1/2"	4.99 ea
-------	--------	---------



Dodge Scat Pack Window Decal

Adhesive backed and applied from the outside of the window.

DZ24	6"	6.99 ea
------	----	---------



Dodge Super Bee Decal

Adhesive backed and applied from the outside of the window.

DD53	4"	4.99 ea
------	----	---------

New!



shown on mirror

OBJECTS IN MIRROR
ARE LOSING

Objects in Mirror Are Losing Decal

Just because your Mopar is bold and powerful doesn't mean it can't have a sense of humor. These high quality computer-cut decals bring a sense of bravado to your rear view mirror.

GF18000	4" x 5/8"	4.99 ea
GF18001	3" x 1/2"	4.99 ea

Reproduction Stripes & Decals



MS305BK



1965-67 Barracuda Stencil/Stripe Sets

Reproduction over roof stencil and stripe sets for 1965-67 Barracuda models. These stripes were originally painted on using the stencil sets, however we also offer vinyl stripes which offer easier application. These complete sets include stripes for the nose, hood, cowl, roof, deck lid and rear valance panel. Made in USA.

1965-67 Stencils

MS300	1965	stencil.....	109.99 set
MS301	1966	stencil.....	109.99 set
MS302	1967	stencil.....	109.99 set

1965 Vinyl Stripes

MS303BK	1965	black.....	109.99 set
MS303WH	1965	white.....	109.99 set
MS303GD	1965	gold.....	109.99 set
MS303SV	1965	silver.....	109.99 set
MS303RD	1965	red.....	109.99 set
MS303BL	1965	blue.....	109.99 set

1966 Vinyl Stripes

MS304BK	1966	black.....	109.99 set
MS304WH	1966	white.....	109.99 set
MS304GD	1966	gold.....	109.99 set
MS304SV	1966	silver.....	109.99 set
MS304RD	1966	red.....	109.99 set
MS304BL	1966	blue.....	109.99 set

1967 Vinyl Stripes

MS305BK	1967	black.....	109.99 set
MS305WH	1967	white.....	109.99 set
MS305GD	1967	gold.....	109.99 set
MS305SV	1967	silver.....	109.99 set
MS305RD	1967	red.....	109.99 set
MS305BL	1967	blue.....	109.99 set



MS306BK



1967-68 Barracuda Lower Body Stripes

Reproduction lower side stripe sets for 1967-68 Barracuda models. These complete sets include decals for the fenders, doors and quarter panels. Apply these stripes to give your Barracuda a showroom new appearance. Made in USA.

Complete Sets

MS306BK	1967-68	black.....	79.99 set
MS306WH	1967-68	white.....	79.99 set
MS306MR	1967-68	maroon.....	79.99 set
MS306BL	1967-68	blue.....	79.99 set
MS306GR	1967-68	green.....	79.99 set

Optional-Deck Lid Stripe

MS307MR	1968	reflective maroon.....	49.99 set
---------	------	------------------------	-----------



MS310

1969 Barracuda Lower Body Stripe Sets

Reproduction lower body side stripe sets for 1969 Barracuda models. These complete sets include decals for the fenders, doors and quarter panels with engine size numbers and 'Cuda logos. These sets help give your vehicle a factory fresh appearance. Officially licensed by Chrysler as a Mopar Authentic Restoration Product.

Barracuda 340

MS308	1969	matte black.....	169.99 set
-------	------	------------------	------------

Barracuda 383

MS309	1969	matte black.....	169.99 set
-------	------	------------------	------------

Barracuda 440

MS310	1969	matte black.....	169.99 set
-------	------	------------------	------------



MS311WH

1969 Barracuda Upper Body Stripe Sets

Reproduction upper body side stripe sets for 1969 Barracuda models. These complete sets include decals for the fenders, doors and quarter panels for a complete replacement. The 340 and 383 decal sets feature engine size number cutouts. Officially licensed by Chrysler as a Mopar Authentic Restoration Product.

Barracuda-No Cutouts

MS311BK	1969	black.....	159.99 set
MS311WH	1969	white.....	159.99 set
MS311RD	1969	red.....	159.99 set

Barracuda 340

MS312BK	1969	black.....	159.99 set
MS312WH	1969	white.....	159.99 set
MS312RD	1969	red.....	159.99 set

Barracuda 383

MS313BK	1969	black.....	159.99 set
MS313WH	1969	white.....	159.99 set
MS313RD	1969	red.....	159.99 set



1969 Barracuda Hood/Header Stripe Sets

Reproduction hood and header stripe set for 1969 Barracuda models. This complete set includes decals for the hood and header panel. Officially licensed by Chrysler as a Mopar Authentic Restoration Product.

MS314	1969	matte black.....	79.99 set
-------	------	------------------	-----------

Reproduction Stripes & Decals



MS315WH



MS322BK



1968 Dart Side Stripe Sets

Reproduction side stripe sets for 1968 Dart models. These complete sets include the fender, door and quarter panel decals and will give your car a showroom appearance. Made in USA.

MS315BK	1968	black	119.99	set
MS315WH	1968	white	119.99	set
MS315RD	1968	red	119.99	set



MS325WH



MS325BK



1973-75 Dart Sport Side Stripe Sets

Reproduction side stripe sets for 1973-75 A-Body Dart Sport models. These sets include the fender, door, quarter panel, tail panel and over-roof decals for a complete replacement. Apply these stripes for a showroom new look. Made in USA.

Dart Sport - Includes Sides And Over Roof

MS322BK	1973	black	249.99	set
MS322WH	1973	white	249.99	set
MS321BK	1974	black	249.99	set
MS321WH	1974	white	249.99	set

Dart Sport - 340-Includes Side Stripes

MS323BK	1973	black	169.99	set
MS323WH	1973	white	169.99	set

Dart Sport - 360-Includes Side Stripes

MS324BK	1974	black	169.99	set
MS324WH	1974	white	169.99	set

Dart Sport - Includes Sides And Over Roof

MS325BK	1975	black	189.99	set
MS325WH	1975	white	189.99	set

Optional - Black Out Stripes-Includes Header, Hood And Cowl

MS326	1973-74	black	109.99	set
-------	---------	-------	--------	-----

Optional - Dodge Quarter Panel Names

MS327BK	1973-74	black	19.99	ea
MS327WH	1973-74	white	19.99	ea



MS319BK



MS316BK



MS317BK



MS318WH



1968-71 Dart Rear Bumble Bee Stripes

Reproduction rear "Bumble Bee" stripe sets for 1968-71 A-Body Dart models. These complete sets include two quarter panel and one deck lid decal for a complete replacement and showroom fresh appearance. Made in USA.

Dart Swinger

MS316RD	1968	black	119.99	set
MS316WH	1968	white	119.99	set
MS316RD	1968	red	119.99	set

Dart GTS

MS317BK	1969	black	129.99	set
MS317WH	1969	white	129.99	set
MS317RD	1969	red	129.99	set

Dart Swinger

MS318BK	1969	black	129.99	set
MS318WH	1969	white	129.99	set
MS318RD	1969	red	129.99	set

Dart

MS319BK	1970-71	black	119.99	set
MS319WH	1970-71	white	119.99	set
MS319RD	1970-71	red	119.99	set
MS319BL	1970-71	blue	119.99	set



quarter panel decal



hood decal



1974-75 Dart Hang 10 Decal Set

Reproduction of the red, white and blue decal set for 1974-75 Dart Hang 10 models. This decal set was applied on surfer edition Dart models. They featured hood stripes and side stripes with the Hang 10 wording and a surfer on the quarter panels. Made in USA.

MA1179	1974-75	Hang 10 edition	304.99	set
--------	---------	-----------------	--------	-----

Reproduction Stripes & Decals



MADE IN USA AUTHENTIC RESTORATION

MS352BK



MS354

MADE IN USA

1971-72 Demon Side Stripe Sets

Reproduction side stripe sets for 1971-72 Demon models. These complete sets include the side, tail panel and all name decals and are available in matte black or white. Curved hood stripes are available only in black. Made in USA.

Complete Sets

MS352BK	1971	matte black	219.99 set
MS352WH	1971	white	219.99 set
MS353BK	1972	matte black	219.99 set
MS353WH	1972	white	219.99 set

Optional-Hood and Cowl Curved Stripes

MS354	1971-72	matte black	129.99 set
-------	---------	-------------	------------



MADE IN USA AUTHENTIC RESTORATION

1971-72 Twister Hood Stripes

Reproduction hood stripes for 1971-72 Twister models. This set is finished in the correct matte black finish, and features the correct step ladder pattern up to the cowl panel. Includes the large center piece and the two point dividers. Made in USA.

MA1178	1971-72	Twister	89.99 set
--------	---------	---------	-----------



MADE IN USA AUTHENTIC RESTORATION

1973 Duster Hood Black Out Set

Reproduction hood black out decal set for 1973 Duster models. Manufactured in the correct matte black finish, these decals run up to the cowl panel. Made in USA.

MA1180	1973		74.99 set
--------	------	--	-----------



MADE IN USA

MADE IN USA AUTHENTIC RESTORATION

MS342BR

1970-75 Gold Duster Stripe Sets

Reproduction side stripe sets for 1970-75 Gold Duster models. These complete sets include side decals, tail panel decals and Gold Duster logos for a complete replacement. Install these stripes for a factory-fresh appearance. Made in USA.

MS342BK	1970	matte black	199.99 set
MS342WH	1970	white	199.99 set
MS342GD	1970	gold	199.99 set
MS342BR	1970	brown	199.99 set
MS343BK	1971	matte black	199.99 set
MS343WH	1971	white	199.99 set
MS343GD	1971	gold	199.99 set
MS343BR	1971	brown	199.99 set
MS344BK	1972	matte black	199.99 set
MS344WH	1972	white	199.99 set
MS344GD	1972	gold	199.99 set
MS344BR	1972	brown	199.99 set
MS345BK	1973-75	matte black	199.99 set
MS345WH	1973-75	white	199.99 set
MS345GD	1973-75	gold	199.99 set
MS345BR	1973-75	brown	199.99 set

MADE IN USA



MS337WH

1970-74 Duster Stripe Sets

Reproduction side stripe sets for 1970-74 Duster models. These complete sets include side decals, tail panel decals and all Duster logos for a complete replacement. Made in USA.

Duster

MS328BK	1970	matte black	169.99 set
MS328WH	1970	white	169.99 set
MS328GD	1970	gold	169.99 set

Duster - 340

MS329BK	1970	matte black	179.99 set
MS329WH	1970	white	179.99 set
MS329GD	1970	gold	179.99 set

Duster

MS330BK	1971	matte black	199.99 set
MS330WH	1971	white	199.99 set

Duster - 340

MS331BK	1971	matte black	199.99 set
MS331WH	1971	white	199.99 set

Duster - Twister with Dust Clouds on quarter stripes

MS332BK	1971	matte black	219.99 set
MS332WH	1971	white	219.99 set

Duster

MS333BK	1972	matte black	199.99 set
MS333WH	1972	white	199.99 set

Duster with Dust Clouds on quarter stripes

MS334BK	1972	matte black	219.99 set
MS334WH	1972	white	219.99 set

Duster - 340 with Dust Clouds on quarter stripes

MS335BK	1972	matte black	219.99 set
MS335WH	1972	white	219.99 set

Duster - Twister with Dust Clouds on quarter stripes

MS336BK	1972	matte black	219.99 set
MS336WH	1972	white	219.99 set

Duster - 340

MS337BK	1973-74	matte black	189.99 set
MS337WH	1973-74	white	189.99 set

Duster - 360

MS338BK	1973-74	matte black	189.99 set
MS338WH	1973-74	white	189.99 set

Reproduction Stripes & Decals



MS359WH



MS360BK



MS362WH



1968-69 Charger Bumble Bee Stripe Sets

Reproduction rear Bumble Bee stripes for 1968-69 Charger models. These complete sets include the two quarter panel and deck lid stripes. The quarter panel stripes have the cutouts for the R/T or 500 logos. Made in USA.

Charger - No Cutouts

MS359BK 1968	black	109.99 set
MS359WH 1968	white	109.99 set
MS359RD 1968	red	109.99 set

Charger R/T

MS360BK 1969	black	119.99 set
MS360WH 1969	white	119.99 set
MS360RD 1969	red	119.99 set

Charger 500

MS362BK 1969	black	129.99 set
MS362WH 1969	white	129.99 set
MS362RD 1969	red	129.99 set

Optional - Turn Signal Hood Depression Decals
MS363 1968-69 matte blk (set of 4) 9.99 set



MS361WH



MS361WH detail



1969 Charger Daytona Stripe Sets

Reproduction rear stripe with "Daytona" cutouts for 1969 Charger Daytona models. These complete sets include the two quarter panel stripes and deck lid stripe. These sets are manufactured to meet or exceed OEM standards. Made in USA.

Charger Daytona

MS361BK 1969	black	159.99 set
MS361WH 1969	white	159.99 set
MS361RD 1969	red	159.99 set

Optional-Turn Signal Hood Depression Decals

MS363 1968-69	matte blk (set of 4)	9.99 set
---------------	----------------------	----------



MS364RD



MS365WH



1970 Charger R/T Bumble Bee Stripe Sets

Reproduction rear Bumble Bee stripes for 1970 Charger R/T models. These complete sets include the two quarter panel and deck lid stripes. Made in USA.

Complete Sets

MS364BK 1970	black	109.99 set
MS364WH 1970	white	109.99 set
MS364RD 1970	red	109.99 set
MS364BL 1970	blue	109.99 set
MS364GR 1970	green	109.99 set

Optional "440" Hood Decals

MS365WH 1970	white	59.99 pr
MS365RD 1970	red	59.99 pr

Optional "Hemi" Hood Decals

MS366WH 1970	white	59.99 pr
MS366RD 1970	red	59.99 pr



MS367WH



1970 Charger R/T Pin Stripe Sets

Reproduction side stripes for 1970 Charger R/T models. These complete sets include the pinstripes that run from the door scoops to the rear quarter panels. Made in USA.

Complete Sets

MS367BK 1970	black	129.99 set
MS367WH 1970	white	129.99 set
MS367RD 1970	red	129.99 set
MS367BL 1970	blue	129.99 set
MS367GR 1970	green	129.99 set



MS369



MS371



1971 Charger R/T Decal Sets

Reproduction complete decal set for 1971 Charger R/T models that include the pinstripes that run from the hood and cowli to the rear quarter panels, vertical door stripes and small R/T hood decal. Made in USA.

Complete Set

MS369 1971	matte black	199.99 set
------------	-------------	------------

Optional - Hood Blackout with R/T Cutouts

MS371 1971	matte black	119.99 set
------------	-------------	------------

Vertical Door Stripe Set

MS380 1971	matte black	199.99 set
------------	-------------	------------



MS372



1972 Charger Rallye Decal Sets

Reproduction decal set for 1972 Charger Rallye models. This sets includes 10 door depression inserts for both sides and deck lid stripe. Officially licensed by Chrysler as a Mopar Authentic Restoration Product.

Set

MS372 1972	matte black	99.99 set
------------	-------------	-----------

Optional - Hood Blackout Stencil

MS373 1972	for painted blackout	109.99 set
------------	----------------------	------------



MS374



MS375



1973-74 Charger Rallye Decal Sets

Reproduction complete decal set for 1973-74 Charger Rallye models. These complete sets include the Rallye side stripes and deck lid stripes. Officially licensed by Chrysler as a Mopar Authentic Restoration Product. Made in USA.

Complete Set

MS374 1973-74	matte black	199.99 set
---------------	-------------	------------

Optional - Hood Blackout Stencil

MS375 1973-74	for painted blackout	109.99 set
---------------	----------------------	------------



MS376



1973-74 Charger Rallye Side Stripes

Reproduction reflective side stripes for 1973-74 Charger Rallye models. These sets include the Sunburst Rallye side reflective laser stripes only. Made in USA.

Complete Sets

MS376 1973-74	red (reflective)	321.99 set
---------------	------------------	------------

MS376GD 1973-74	gold (reflective)	321.99 set
-----------------	-------------------	------------

Options-Hood Blackout stencil

MS375 1973-74		109.99 set
---------------	--	------------

Reproduction Stripes & Decals



AUTHENTIC RESTORATION

MS381WH



MS382BK



MS383BK

Made in USA

1968-70 Coronet Bumble Bee Stripe Sets

Reproduction Bumble Bee side stripe sets for 1968-70 B-Body Coronet models. These complete sets include two quarter panel and one-deck lid decal for a complete replacement and factory fresh look. The R/T sets feature correct cutouts for R/T logos. Officially licensed by Chrysler as a Mopar Authentic Restoration Product. Made in USA.

Coronet			
MS381BK	1968	black.....	109.99 set
MS381WH	1968	white.....	109.99 set
MS381RD	1968	red.....	109.99 set
Coronet R/T			
MS382BK	1969	black.....	129.99 set
MS382WH	1969	white.....	129.99 set
MS382RD	1969	red.....	129.99 set
Coronet			
MS383BK	1970	black.....	109.99 set
MS383WH	1970	white.....	109.99 set
MS383RD	1970	red.....	109.99 set
MS383BL	1970	blue.....	109.99 set
MS383GR	1970	green.....	109.99 set

Made in USA



AUTHENTIC RESTORATION

1968 Super Bee Tail Lamp Panel Black Out

Reproduction tail lamp panel black out for 1968 Super Bee models. This decal surrounds the rear tail moldings and features the correct matte black finish. Made in USA.

MB1757	1968	matte black.....	74.99 ea
--------	------	------------------	----------

Made in USA

1970 Coronet Side Scoop Decals

Reproduction side scoop decals for 1970 Coronet models. These decals are applied on the inside of the side scoop and feature the correct matte black finish. Made in USA.

MB1759	1970	matte black.....	19.99 pr
--------	------	------------------	----------



AUTHENTIC RESTORATION

MS385BK

Made in USA

1968-70 Coronet Super Bee Stripe Sets

Reproduction stripe sets for 1968-70 Coronet Super Bee models. These complete sets include two quarter panel stripes with Super Bee circles and one deck lid stripe for a complete replacement. Made in USA.

Complete Sets			
MS384BK	1968	black.....	149.99 set
MS384WH	1968	white.....	149.99 set
MS384RD	1968	red.....	149.99 set
MS385BK	1969-70	black.....	149.99 set
MS385WH	1969-70	white.....	149.99 set
MS385RD	1969-70	red.....	149.99 set
Optional - Hood Scoop Decal "Six Pack"			
MS387	1969	red.....	29.99 pr



AUTHENTIC RESTORATION

MS388BK

Made in USA

1970 Super Bee Side Stripe Sets

Reproduction side stripe sets for 1970 Super Bee models. These complete sets include two quarter panel reverse "C" stripes with Super Bee circles. Made in USA.

MS388BK	1970	black.....	169.99 set
MS388WH	1970	white.....	169.99 set
MS388RD	1970	red.....	169.99 set
MS388BL	1970	blue.....	169.99 set
MS388GR	1970	green.....	169.99 set



AUTHENTIC RESTORATION

MS389BK



MS390

Made in USA

1971 Super Bee Side Stripe Sets

Reproduction side stripe sets for 1971 Super Bee models. These complete sets include the fender, side, cowl and hood stripes with the large Super Bee blackout hood decal and all bee character decals. Made in USA.

Complete Set			
MS389BK	1971	matte black.....	299.99 set
Optional - Hood Blackout Decal			
MS390	1971	matte black.....	149.99 set

Reproduction Stripes & Decals



MS395MR



MS396RD



MS397WH



1968-70 GTX Side Stripe Sets

Reproduction side stripe sets for 1968-70 B-Body GTX models. These complete sets include all of the decals to put your GTX in showroom condition. Made in USA.

Lower Side Stripes with Reflective Tail Panel

MS395BK	1968	black.....	119.99 set
MS395WH	1968	white.....	119.99 set
MS395MR	1968	maroon.....	119.99 set
MS395BL	1968	blue.....	119.99 set
MS395GR	1968	green.....	119.99 set

Lower Pinstripes

MS396WH	1969	white - reflective.....	79.99 set
MS396RD	1969	red - reflective.....	79.99 set

Mid Body Side Stripes

MS397BK	1970	black - reflective.....	129.99 set
MS397WH	1970	white - reflective.....	129.99 set
MS397GD	1970	gold - reflective.....	129.99 set

Decal Application Cleaner, Gel & UV Protectant

Don't make an expensive mistake by trying to put on your decals the hard way! Help ensure a safe application by a proper preparation of the vehicles painted surface with **Pre-App®** surface cleaner. The **Slide-on®** Application Gel is specially formulated for applying automotive stripe kits by eliminating air bubbles and helps temporarily overcome the tack of pressure sensitive materials during installation. **Slide-over® UV Protectant** was designed to give an optically enhanced appearance by repelling dirt, oils, tree sap, smudges and stains. **Application Gel and UV Protectant Sold as A Kit, Buy Both and Save!**

33910 application gel/UV protectant 30.99 kit

Individual Items

33913	Pre-App® surface cleaner.....	9.99 ea
33911	Slide-on® application gel.....	16.99 ea
33912	Slide-over® UV protectant.....	16.99 ea



Plastic Detailing Scraper

This 4 side edge, 4 different angle corner plastic razor blade scraper can be used for many detailing jobs. For use on most surfaces, excellent for removing unwanted decals, tags, pin stripes, tar, sap, or adhesive. For best results spray contained area with appropriate liquid remover and gently scrape away.

K89830 1" x 3" x 2.5"..... 1.99 ea



MS400BK



1971 GTX Hood to Fender Stripe Sets

Reproduction GTX hood to fender stripe sets for 1971 Plymouth GTX models. These complete sets include reflective hood to fender stripes, Plymouth circle, GTX deck logo and hood bezel engine callouts. Made in USA.

Note: For non-air grabber vehicles.

GTX 440

MS400BK	1971	black (reflective).....	199.99 set
MS400WH	1971	white (reflective).....	199.99 set
MS400GD	1971	gold (reflective).....	199.99 set

GTX 440+6

MS401BK	1971	black (reflective).....	199.99 set
MS401WH	1971	white (reflective).....	199.99 set
MS401GD	1971	gold (reflective).....	199.99 set



MS404BK



1971 GTX Body Pinstripe Sets

Reproduction GTX body pinstripe sets for 1971 GTX models equipped with N96 air grabber option. These complete sets include the fine body pinstripes, Plymouth circle, GTX deck name, Air Grabber teeth, door top lettering and fender engine callouts. Officially licensed by Chrysler as a Mopar Authentic Restoration Product. Made in USA.

Note: These sets do not include the hood to fender stripes.

GTX 440 w/Air Grabber

MS404BK	1971	black.....	129.99 set
MS404WH	1971	white.....	129.99 set
GTX 440+6 w/Air Grabber			
MS405BK	1971	black.....	129.99 set
MS405WH	1971	white.....	129.99 set

GTX Hemi w/Air Grabber

MS406BK	1971	black.....	129.99 set
MS406WH	1971	white.....	129.99 set



1971 GTX & Road Runner Rear Blackout

Reproduction rear valance blackout decals for 1971 GTX and Road Runner models. Made in USA.

MS447 1971 matte black..... 49.99 set

Reproduction Stripes & Decals



MS431



Made in USA



Authentic Motorcraft

1968-69 Road Runner Decal Sets

Reproduction reflective decal sets for 1968-69 Road Runner models. Complete set includes hood paint schematic, steering wheel horn decal and all birds. 1969 sets also include the horn speaker decal. Made in USA.

Complete 6 Piece Sets

MS430	1968	79.99 set
MS430A	1968 w/aluminum deck	79.99 set
Complete 7 Piece Set		
MS431	1969	79.99 set

Optional - Upper Body Stripes

MS432WH	1969 reflective white	109.99 set
MS432RD	1969 reflective red	109.99 set



MS601GD



Made in USA



Authentic Motorcraft

1970 Road Runner Decal Sets

Reproduction decal sets for 1970 Road Runner models. Each set includes the reflective gold dust trail stripes and Road Runner birds. Deck lid stripe sets which include the deck lid stripe with the "Road Runner" cutout and the bird are also available. Made in USA.

Gold Side Stripe Set

MS601GD	1970 gold (reflective)	209.99 set
---------	------------------------	------------

Deck Lid Stripe Sets

MS435BK	1970 black (reflective)	85.99 set
MS435WH	1970 white (reflective)	85.99 set
MS435GD	1970 gold (reflective)	85.99 set
MS435GB	1970 black (gloss)	85.99 set



MS443BK



Made in USA



Authentic Motorcraft

1971 Road Runner Roof & Hood Stripe Sets

Reproduction roof stripe sets for 1971 Road Runner models. These complete sets include reflective strobe roof stripes, all birds, Plymouth circle and hood bezel engine callouts. The Air Grabber models include the reflective roof stripes, all birds, Plymouth circle, fender engine numbers, Air Grabber teeth and door top lettering. Available in reflective black (BK), reflective white (WH), or reflective gold (GD). Officially licensed by Chrysler as a Mopar Authentic Restoration Product. Made in USA.

Without Air Grabber

MS438BK	1971 Road Runner 340	269.99 set
MS438WH	1971 Road Runner 340	269.99 set
MS438GD	1971 Road Runner 340	269.99 set
MS439BK	1971 Road Runner 383	269.99 set
MS439WH	1971 Road Runner 383	269.99 set
MS439GD	1971 Road Runner 383	269.99 set
MS440BK	1971 Road Runner 440	269.99 set
MS440WH	1971 Road Runner 440	269.99 set
MS440GD	1971 Road Runner 440	269.99 set
MS441BK	1971 Road Runner 440+6	269.99 set
MS441WH	1971 Road Runner 440+6	269.99 set
MS441GD	1971 Road Runner 440+6	269.99 set

With Air Grabber

MS442BK	1971 Road Runner 340	289.99 set
MS442WH	1971 Road Runner 340	289.99 set
MS442GD	1971 Road Runner 340	289.99 set
MS443BK	1971 Road Runner 383	289.99 set
MS443WH	1971 Road Runner 383	289.99 set
MS443GD	1971 Road Runner 383	289.99 set
MS444BK	1971 Road Runner 440	289.99 set
MS444WH	1971 Road Runner 440	289.99 set
MS444GD	1971 Road Runner 440	289.99 set
MS445BK	1971 Road Runner 440+6	289.99 set
MS445WH	1971 Road Runner 440+6	289.99 set
MS445GD	1971 Road Runner 440+6	289.99 set
MS446BK	1971 Road Runner Hemi	289.99 set
MS446WH	1971 Road Runner Hemi	289.99 set
MS446GD	1971 Road Runner Hemi	289.99 set



MS459



Made in USA



Authentic Motorcraft

1972 Road Runner Decal Sets

Reproduction hood and deck lid decal sets for 1972 Road Runner models. Sets include hood and deck lid stripes, all birds, Air Grabber teeth, door top letters and engine size numbers for the fenders. Available in matte black. Made in USA.

MS459	1972 Road Runner 340	189.99 set
MS460	1972 Road Runner 400	189.99 set
MS461	1972 Road Runner 440	189.99 set



MS454BK



Made in USA



Authentic Motorcraft

1972 Road Runner and GTX Roof Stripes

Reproduction hood stripe sets for 1972 Road Runner and GTX models that include reflective roof stripes, all birds and hood bezel engine numbers. The Air Grabber models include reflective roof stripes, all birds, fender engine callouts, Air Grabber teeth and door top lettering. Made in USA.

Road Runner w/o engine numbers

MS454BK	1972 reflective black	269.99 set
MS454WH	1972 reflective white	269.99 set
MS454GD	1972 reflective gold	269.99 set

Road Runner 340

MS448BK	1972 reflective black	269.99 set
MS448WH	1972 reflective white	269.99 set
MS448GD	1972 reflective gold	269.99 set

Road Runner 400

MS449BK	1972 reflective black	269.99 set
MS449WH	1972 reflective white	269.99 set
MS449GD	1972 reflective gold	269.99 set

Road Runner/GTX 440

MS450BK	1972 reflective black	269.99 set
MS450WH	1972 reflective white	269.99 set
MS450GD	1972 reflective gold	269.99 set

Road Runner 340 w/Air Grabber

MS551BK	1972 reflective black	299.99 set
MS551WH	1972 reflective white	299.99 set
MS551GD	1972 reflective gold	299.99 set

Road Runner 400 w/Air Grabber

MS552BK	1972 reflective black	299.99 set
MS552WH	1972 reflective white	299.99 set
MS552GD	1972 reflective gold	299.99 set

Road Runner/GTX 440 w/Air Grabber

MS553BK	1972 reflective black	299.99 set
MS553WH	1972 reflective white	299.99 set
MS553GD	1972 reflective gold	299.99 set



1971 GTX & Road Runner Hood Pinstripes

Reproduction hood pinstripes for 1971 GTX and Road Runner models. These pinstripes are applied to the depression on each side of the hood. Available in your choice original matte black or white. Made in USA.

Note: Engine size inserts are not included.

MS402BK	1971 matte black	39.99 set
MS402WH	1971 white	39.99 set



Made in USA



Authentic Motorcraft

Reproduction Stripes & Decals



MS455BK



Made in USA



1972 Road Runner/GTX Hood/Fender Stripes

Reproduction hood to fender stripe sets for 1972 Road Runner and GTX models. These complete sets include hood to fender "Tank Tracks" stripes, four birds and hood bezel engine numbers. Made in USA.

Road Runner w/ engine numbers

MS455BK	1972	matte black	189.99	set
MS455WH	1972	white	189.99	set
Road Runner 340				
MS456BK	1972	matte black	189.99	set
MS456WH	1972	white	189.99	set
Road Runner 400				
MS457BK	1972	matte black	189.99	set
MS457WH	1972	white	189.99	set
Road Runner/GTX 440				
MS458BK	1972	matte black	189.99	set
MS458WH	1972	white	189.99	set



MS463WH



Made in USA



1973 Road Runner Stripe Sets

Reproduction over-the-roof stripe sets for 1973 Road Runner models that include side stripes, strobe roof stripes, hood bulge stripes, engine numbers and all birds. Available in plain or reflective finish. Officially licensed by Chrysler as a Mopar Authentic Restoration Product. Made in USA.

Road Runner 318

MS462BK	1973	black	249.99	set
MS462WH	1973	white	249.99	set
MS462RD	1973	red	249.99	set
Road Runner 340				
MS463BK	1973	black	249.99	set
MS463WH	1973	white	249.99	set
MS463RD	1973	red	249.99	set
Road Runner 400				
MS464BK	1973	black	249.99	set
MS464WH	1973	white	249.99	set
MS464RD	1973	red	249.99	set

Road Runner 440

MS465BK	1973	black	249.99	set
MS465WH	1973	white	249.99	set
MS465RD	1973	red	249.99	set

Road Runner 318 - Reflective

MS468BK	1973	black	299.99	set
MS468WH	1973	white	299.99	set
MS468RD	1973	red	299.99	set
MS468GD	1973	gold	299.99	set

Road Runner 340 - Reflective

MS469BK	1973	black	299.99	set
MS469WH	1973	white	299.99	set
MS469RD	1973	red	299.99	set
MS469GD	1973	gold	299.99	set

Road Runner 400 - Reflective

MS470BK	1973	black	299.99	set
MS470WH	1973	white	299.99	set
MS470RD	1973	red	299.99	set
MS470GD	1973	gold	299.99	set

Road Runner 440 - Reflective

MS471BK	1973	black	299.99	set
MS471WH	1973	white	299.99	set
MS471RD	1973	red	299.99	set
MS471GD	1973	gold	299.99	set



MS472WH



Made in USA



1974 Road Runner Stripe Sets

Reproduction over roof stripe sets for 1974 Road Runner models that include side stripes, solid roof stripes, hood bulge stripes, engine numbers and all birds. Available in plain or reflective finish. Made in USA.

Note: Some early 1974 models used the strobe roof stripes. See 1973 Road Runner stripe sets for strobe type decals.

Road Runner 318

MS472BK	1974	black	249.99	set
MS472WH	1974	white	249.99	set
MS472RD	1974	red	249.99	set

Road Runner 360

MS473BK	1974	black	249.99	set
MS473WH	1974	white	249.99	set
MS473RD	1974	red	249.99	set

Road Runner 400

MS474BK	1974	black	249.99	set
MS474WH	1974	white	249.99	set
MS474RD	1974	red	249.99	set

Road Runner 440

MS475BK	1974	black	249.99	set
MS475WH	1974	white	249.99	set
MS475RD	1974	red	249.99	set

Road Runner 318 - Reflective

MS476BK	1974	black	299.99	set
MS476WH	1974	white	299.99	set
MS476RD	1974	red	299.99	set
MS476GD	1974	gold	299.99	set

Road Runner 360 - Reflective

MS477BK	1974	black	299.99	set
MS477WH	1974	white	299.99	set
MS477RD	1974	red	299.99	set
MS477GD	1974	gold	299.99	set

Road Runner 400 - Reflective

MS478BK	1974	black	299.99	set
MS478WH	1974	white	299.99	set
MS478RD	1974	red	299.99	set
MS478GD	1974	gold	299.99	set

Road Runner 440 - Reflective

MS479BK	1974	black	299.99	set
MS479WH	1974	white	299.99	set
MS479RD	1974	red	299.99	set
MS479GD	1974	gold	299.99	set



MS480WH



Made in USA



1975 Road Runner Stripe Sets

Reproduction stripe sets for 1975 Road Runner models. These sets include the side, tail and over the roof stripes with all 4 birds for a complete replacement.

Note: Tunnel decal is not included with the stripe set.

Stripe Sets

MS480BK	1975	black	169.99	set
MS480WH	1975	white	169.99	set
MS480RD	1975	gold	169.99	set
MS480SY	1975	silver	169.99	set

Options - Tunnel Decal

MS481	1975	black/white	109.99	ea
-------	------	-------------	--------	----



MS487WH



Made in USA



MS487BK



Made in USA



1970 Superbird Decal Sets

Reproduction decal sets for 1970 Superbird models. These complete sets include the front nose block with bird, two quarter panel Plymouth decals, both wing birds and deck lid bird. Officially licensed by Chrysler as a Mopar Authentic Restoration Product. Made in USA.

MS487BK	1970	black	309.99	set
MS487WH	1970	white	309.99	set



MS492WH



Made in USA



1970 Barracuda Side Stripe Sets

Reproduction strobe style side stripes for 1970 Barracuda models. This complete set includes decals for the doors, fenders and quarter panels. Officially licensed by Chrysler as a Mopar Authentic Restoration Product.

MS492BK	1970	black	128.99	set
MS492WH	1970	white	128.99	set
MS492MG	1970	magenta	128.99	set



MS488BK



Made in USA



1970 'Cuda Hockey Stick Stripe Sets

Reproduction Hockey Stick side stripes for 1970 'Cuda models. This set includes engine callouts for both quarter panels and two hockey stick stripes. Available exclusively in black. Officially licensed by Chrysler as a Mopar Authentic Restoration Product.

Note: Though cosmetically correct for 'Cuda models only, will also fit 1970 Barracuda models.

MS488BK	1970	black	99.99	set
Barracuda 383				
MS489BK	1970	black	99.99	set
Barracuda 440				
MS490BK	1970	black	99.99	set
MS490MB	1970	matte black	99.99	set
Barracuda Hemi				
MS491BK	1970	black	99.99	set

Reproduction Stripes & Decals



1970 AAR 'Cuda Side Stripe Sets

Reproduction side stripes for 1970 limited edition AAR 'Cuda models. These include the strobe decals for the doors, fenders and quarter panels with the "Cuda AAR" shield for a complete replacement. Officially licensed by Chrysler as a Mopar Authentic Restoration Product. Made in USA.

MS493 1970 matte black 209.99 set



MS494BK



1971 'Cuda Side Stripe Sets

Reproduction Billboard side stripes for 1971 Plymouth 'Cuda models. This set includes decals for the quarter panels and doors with engine size callouts for an authentic appearance. Officially licensed by Chrysler as a Mopar Authentic Restoration Product. Made in USA.

Barracuda 340
MS494BK 1971 matte black 199.99 set
MS494WH 1971 white 199.99 set
Barracuda 383
MS495BK 1971 matte black 199.99 set
MS495WH 1971 white 199.99 set
Barracuda 440
MS496BK 1971 matte black 199.99 set
MS496WH 1971 white 199.99 set
Barracuda Homi
MS497BK 1971 matte black 199.99 set
MS497WH 1971 white 199.99 set



MS498BK

1972 Barracuda Upper Side Stripe Sets

Reproduction upper side stripes for 1972 Barracuda models. This set includes decals for the upper fenders, doors and quarter panels. Officially licensed by Chrysler as a Mopar Authentic Restoration Product. Made in USA.

MS498BK 1972 matte black 149.99 set
MS498WH 1972 white 149.99 set



MS499WH

1973-74 Barracuda Side Stripe Sets

Reproduction upper side stripes for 1973-74 Barracuda models. This set includes decals for the upper fenders, doors and quarter panels. Officially licensed by Chrysler as a Mopar Authentic Restoration Product. Made in USA.

MS499BK 1973-74 matte black 139.99 set
MS499WH 1973-74 white 139.99 set



1970 Challenger T/A Stripe Set

Reproduction side stripe set for 1970 Challenger T/A models. This set includes the fender, door, rear quarter panel stripes, "Challenger T/A" and "340 Six Pak" decals for a complete replacement. Officially licensed by Chrysler as a Mopar Authentic Restoration Product. Made in USA.

MS505BK 1970 matte black 189.99 set



1970 Challenger R/T Bumble Bee Stencils

Stencils used to paint the rear Bumble Bee stripes on 1970 Challenger R/T models. This set includes all three stencils for the quarter panel and deck lid stripes. Officially licensed by Chrysler as a Mopar Authentic Restoration Product. Made in USA.

MS500 1970 99.99 set



1970 Challenger R/T Side Stripe Sets

Reproduction side stripes for 1970 Challenger base and R/T models. These stripe sets include the rear quarter panel, door and fender stripes. The R/T fender stripes feature correct R/T cutouts for an authentic look. Officially licensed by Chrysler as a Mopar Authentic Restoration Product. Made in USA.

Note: The hood blackout decal is not included in these sets.

Challenger
MS502BK 1970 black 109.99 set
MS502WH 1970 white 109.99 set
MS502RD 1970 red 109.99 set
MS502BL 1970 blue 109.99 set
MS502MG 1970 magenta 109.99 set
MS502GR 1970 green 109.99 set
Challenger R/T
MS503BK 1970 black 129.99 set
MS503WH 1970 white 129.99 set
MS503RD 1970 red 129.99 set
MS503BL 1970 blue 129.99 set
MS503MG 1970 magenta 129.99 set
MS503GR 1970 green 129.99 set



MS504BK



MS508WH



1970-71 Challenger Hood Blackout Decal

Reproduction hood blackout decal for 1970-71 Challenger models. The R/T decal features the correct R/T cutout, the non R/T decal does not have any cutouts. Made in USA.

Without R/T Cut Outs
MS504BK 1970-71 matte black 119.99 set
MS504WH 1970-71 white 119.99 set
With R/T Cut Outs
MS508BK 1971 matte black 119.99 set
MS508WH 1971 white 119.99 set



MS507BK



1971 Challenger Side Stripe Sets

Reproduction side stripes for 1971 Challenger and Challenger R/T models. These quality sets include the fender, door and rear quarter panel stripes. On the Challenger R/T sets, the quarter panel stripes feature R/T cutouts and include a small R/T pinstripe decal for the hood. Made in USA.

Note: The hood blackout decal is not included in any of these sets.

Challenger
MS506BK 1971 black 119.99 set
MS506WH 1971 white 119.99 set
Challenger R/T
MS507BK 1971 black 129.99 set
MS507WH 1971 white 129.99 set
Optional - Rear Quarter Panel Scoop Blackouts
MS509BK 1971 matte black 14.99 set



1972-74 Challenger Rallye Side Stripes

Reproduction side stripes for 1972-74 Challenger Rallye models. This complete set includes the strobe stripes that run from the front fender to the door. Made in USA.

MS510BK 1972-74 matte black 159.99 set

Weatherstrip



1970 Superbird Nose Cone Seal

Reproduction 3" nose cone seal for 1970 Superbird models. 2 required per vehicle.

MB2223 1970..... 19.99 ea

New!



MB1249

1962-76 Hood to Radiator Seal

Reproduction hood to radiator support seal for various 1962-76 Mopar models. This seal is installed on the front of the hood, and seals the area between the hood and the radiator support.

A-Body	
1966 Barracuda, Dart, Valiant	
MA9887 1966	49.99 ea
1967-72 Valiant	
MA2460 1967-72	49.99 ea
1971-72 Demon	
MA82044 1971-72	69.99 ea
1970-72 Duster	
MA2460 1970-72	49.99 ea
1967-69 Barracuda/Dart	
MA2460 1967-69	49.99 ea

B-Body	
MB1177 1962-65 narrow version	39.99 ea
MB1178 1963-65 wide version	29.99 ea
MB1248 1966-67 all	49.99 ea
MB1249 1968-69 all	24.99 ea
MB1250 1970 all	44.99 ea
MB1251 1971-72 all	49.99 ea
MB1252 1973-74 all	49.99 ea

E-Body	
ME536 1970-74 all	59.99 ea



MB1173

1962-76 Hood to Cowl Seal

Help keep water and dirt out of the engine bay by installing a replacement hood to cowl seal. Available for various 1962-76 Mopar A, B and E-Body models.

A-Body	
MA9873 1963-66	31.99 ea
MA9874 1967-76	12.99 ea

B-Body	
MB2224 1962-65	34.99 ea
MB1173 1966-70	22.99 ea
MB1174 1971-74	34.99 ea

E-Body	
ME535 1970-74	16.99 ea



MA9803



MB1261

1962-76 Windshield Weatherstrip

Prevent interior damage from windshield leaks! These weatherstrips for 1962-76 A-Body and B-Body models is manufactured to original specifications to replace your existing warped or damaged windshield weatherstripping.

A-Body	
Dart	
MA9801 1963-66 all exc convertible	84.99 ea
MA9802 1967-69 convertible	89.99 ea
MA9803 1968-76 hdp exc Dart Sport	84.99 ea
MA9804 1968-76 2/4 dr sedan	94.99 ea
Demon/Dart Sport	
MA9805 1971-76 accepts trim	89.99 ea
Duster	
MA9805 1970-76 accepts trim	89.99 ea
Valiant	
MA9801 1963-66 hardtop/sedan/wagon	84.99 ea
MA9804 1968-76 2/4 dr sedan	94.99 ea
MA9803 1971-75 2 dr hardtop	84.99 ea
MA9805 1970-76 accepts trim	89.99 ea
Barracuda	
MA9801 1964-66 2 dr hardtop	84.99 ea
MA9806 1967 2 dr hdp accepts trim	169.99 ea
MA9803 1968-69 2 dr hardtop	84.99 ea
MA9802 1967-69 convertible	89.99 ea

B-Body	
Dart	
MB1255 1962 2 dr hdp/sdn/wgn.	94.99 ea
Belvedere	
MB1255 1962-63 all accepts trim	94.99 ea
MB1256 1964-65 all exc convertible	94.99 ea
MB1257 1964-65 convertible	81.99 ea
MB1258 1966-67 2 dr hardtop	94.99 ea
MB1260 1968-70 convertible	94.99 ea
MB1261 1968-70 2 dr hardtop/sedan	69.99 ea
Charger	
MB1258 1966-67 all	94.99 ea
MB1261 1968-70 all	69.99 ea
Coronet	
MB1255 1962-63 all accepts trim	94.99 ea
MB1256 1964-65 all exc convertible	94.99 ea
MB1257 1964-65 convertible	81.99 ea
MB1258 1966-67 2 dr hardtop	94.99 ea
MB1260 1968-70 convertible	94.99 ea
MB1261 1968-70 2 dr hardtop/sedan	69.99 ea
Fury	
MB1255 1962-63 all accepts trim	94.99 ea
MB1256 1964 all exc convertible	94.99 ea
MB1257 1964 convertible	81.99 ea
Road Runner	
MB1261 1968-70 2 dr hardtop/sedan	69.99 ea
MB1260 1968-70 convertible	94.99 ea
Satellite	
MB1256 1965 all exc convertible	94.99 ea
MB1257 1965 convertible	81.99 ea
MB1258 1966-67 2 dr hardtop	94.99 ea
MB1260 1968-70 convertible	94.99 ea
MB1261 1968-70 2 dr hardtop/sedan	69.99 ea
Super Bee	
MB1261 1968-70 2 dr hardtop/sedan	69.99 ea
MB1260 1968-70 convertible	94.99 ea



MA9808

MA9808 detail



MA9808 installed

1963-76 Windshield Lock Strip

Windshield seal lock strip for a variety of 1963-76 Dodge and Plymouth A-Body vehicles.

Chrome	
PW1042 1963-66 all exc convertible	14.99 ea
Black	
MA9808 1970-76 Duster	99.99 ea
MA9808 1971-76 Demon/Dart Sport	99.99 ea

New!



MB1288

1963-72 Vent Window Weatherstrip

Seal out moisture and reduce wind noise in the cabin by replacing damaged vent window weatherstripping. For various 1963-72 A-Body and 1966-70 B-Body models.

A-Body	
MA2463 1963-66 2 dr. hardtop	99.99 pr
MA2463 1963-66 2 dr. convertible	99.99 pr
MA2464 1967-69 2 dr convertible	99.99 pr
MA2464 1967-69 2 dr hardtop	99.99 pr
MA2464 1967-69 2 dr fastback	99.99 pr
MA2464 1970-72 2 dr hardtop	99.99 pr
B-Body	
MB192062 1966-67 2 dr convertible	99.99 pr
MB192062 1966-67 2 dr hardtop	99.99 pr
MB192062 1968-70 2 dr convertible	99.99 pr
MB1288 1968-70 2 dr hardtop	89.99 pr
MB1288 1968-70 2 dr sedan	89.99 pr



MB2237

1962-65 B-Body Vent Window Glass Run

Replacement vent window glass run weatherstrip. This weatherstrip mounts to the back of the vent window frame and runs vertically down the window channel.

MB2236 1962-63 2 door hardtop	29.99 pr
MB2237 1962-65 2 door sedan	29.99 pr
MB2238 1964-65 2 door hardtop	29.99 pr

Weatherstrip



MM8283

1962-76 Door Glass Weatherstrip

Replacement door glass weatherstrip for 1962-76 Dodge and Plymouth vehicles. Available in 8-piece sets including both inner and outer weatherstripping, or in 4-piece sets with outer weatherstripping only.

Note: *Indicated kits include inner and outer window weatherstrip for front doors only.

**4 piece is inner and outer door pieces for models with pop out option.

A-Body

Barracuda	
MA9831	1964-66 Sport hardtop - 8 piece..... 99.99 set
MA9832	1964-66 Sport hardtop - 4 piece..... 84.99 set
MA9833	1967-69 2 door notchback - 8 piece..... 109.99 set
MA9834	1967-69 2 door notchback - 4 piece..... 69.99 set
MA9835	1967-69 2 door fastback - 8 piece..... 109.99 set
MA9836	1967-69 2 door fastback - 4 piece..... 89.99 set
MA9837*	1967-69 convertible - 4 piece..... 109.99 set
Dart	
MA9838	1963-66 convertible - 8 piece..... 84.99 set
MA9839	1963-66 convertible - 4 piece..... 59.99 set
MA9840	1963-66 2 door sedan - 8 piece..... 89.99 set
MA9841	1963-66 2 door hardtop - 8 piece..... 94.99 set
MA9842	1963-66 2 door hardtop - 4 piece..... 79.99 set
MA9843	1963-66 4 door sedan/wagon - 8 piece..... 99.99 set
MA9844*	1964-66 2 door GT hardtop - 4 piece..... 99.99 set
MA9845	1967-69 convertible - 8 piece..... 109.99 set
MA9846	1967-69 convertible - 4 piece..... 109.99 set
MA9847	1967-69 2 door sedan - 8 piece..... 109.99 set
MA9848	1967-69 2 door sedan - 4 piece..... 69.99 set
MA9849	1967-69 4 door sedan - 8 piece..... 109.99 set
MA9850	1967-69 2 door coupe - 8 piece..... 109.99 set
MA9851	1967-69 2 door coupe - 4 piece..... 69.99 set
MA9852	1970-71 2 door hardtop - 8 piece..... 119.99 set
MA9853	1970-71 2 door hardtop - 4 piece..... 89.99 set
MA9854*	1970-72 Sport/Demon - 4 piece..... 109.99 set
MA1173	1970-72 4 door sedan - 8 piece..... 109.99 set
MA1174	1973-76 4 door sedan - 8 piece..... 109.99 set
Valiant	
MA9856*	1963-66 2 door sedan - 4 piece..... 99.99 set
MA9857*	1963-66 4 door sedan - 4 piece, front..... 99.99 set
MA9858*	1963-66 2 door hardtop - 4 piece..... 99.99 set
MA9847	1967-69 2 door sedan - 8 piece..... 109.99 set
MA9848	1967-69 2 door sedan - 4 piece..... 69.99 set
MA9854*	1970-72 2 door hardtop - 4 piece..... 109.99 set
Duster/Demon	
MA9859	1970-72 2 door hardtop - 4 piece..... 99.99 set
MA9860	1970-72 2 door hardtop - 2 piece..... 69.99 set
Belvedere	
MB1295	1962 2 door hardtop - 4 piece..... 99.99 set
MB1296	1962 2 door sedan - 4 piece..... 99.99 set
MB1297	1962 4 door sedan - 8 piece..... 99.99 set
MB1145	1963 2 door hardtop - 4 piece..... 99.99 set
MB1130	1963-65 2 door sedan - 4 piece..... 99.99 set
MB1131	1963-65 4 door sedan - 8 piece..... 99.99 set
MB1127	1963-65 2 door sedan - 4 piece w/flt chrome bead..... 109.99 set
MB1128	1963-65 2 door hardtop - 4 piece w/flt chrome bead..... 109.99 set
MB1129	1964-65 2 door hardtop - 4 piece w/flt chrome bead..... 109.99 set
MM8281	1964-65 2 door hardtop - 8 piece w/flt chrome bead..... 119.99 set
MB1132	1966-67 2 door sedan - 8 piece..... 109.99 set
MB1133	1966-67 2 door sedan - 4 piece..... 69.99 set
MB1134	1966-67 convertible - 8 piece..... 119.99 set
MB1135	1966-67 convertible - 4 piece..... 64.99 set
MB1136	1966-67 2 door hardtop - 8 piece..... 114.99 set
MB1137	1966-67 2 door hardtop - 4 piece..... 79.99 set
MB1138	1966-70 4 door sedan - 8 piece..... 99.99 set
MB1139	1966-70 4 door wagon - 8 piece..... 114.99 set
MB1146	1968 convertible - 8 piece..... 119.99 set
MB1149	1968 convertible - 4 piece..... 79.99 set
MB1142**	1968-70 2 door coupe, w/popout - 4 piece..... 99.99 set

B-Body

MB1295	1962 2 door hardtop - 4 piece..... 99.99 set
MB1296	1962 2 door sedan - 4 piece..... 99.99 set
MB1297	1962 4 door sedan - 8 piece..... 99.99 set
MB1145	1963 2 door hardtop - 4 piece..... 99.99 set
MB1130	1963-65 2 door sedan - 4 piece..... 99.99 set
MB1131	1963-65 4 door sedan - 8 piece..... 99.99 set
MB1127	1963-65 2 door sedan - 4 piece w/flt chrome bead..... 109.99 set
MB1128	1963-65 2 door hardtop - 4 piece w/flt chrome bead..... 109.99 set
MB1129	1964-65 2 door hardtop - 4 piece w/flt chrome bead..... 109.99 set
MM8281	1964-65 2 door hardtop - 8 piece w/flt chrome bead..... 119.99 set
MB1132	1966-67 2 door sedan - 8 piece..... 109.99 set
MB1133	1966-67 2 door sedan - 4 piece..... 69.99 set
MB1134	1966-67 convertible - 8 piece..... 119.99 set
MB1135	1966-67 convertible - 4 piece..... 64.99 set
MB1136	1966-67 2 door hardtop - 8 piece..... 114.99 set
MB1137	1966-67 2 door hardtop - 4 piece..... 79.99 set
MB1138	1966-70 4 door sedan - 8 piece..... 99.99 set
MB1139	1966-70 4 door wagon - 8 piece..... 114.99 set
MB1146	1968 convertible - 8 piece..... 119.99 set
MB1149	1968 convertible - 4 piece..... 79.99 set
MB1142**	1968-70 2 door coupe, w/popout - 4 piece..... 99.99 set

B-Body Continued

Charger	
MB1299	1966-67 2 door fastback - 10 piece..... 104.99 set
MB1125	1968-70 2 door hardtop - 8 piece..... 109.99 set
MB1126	1968-70 2 door hardtop - 4 piece..... 69.99 set
MM8279	1971-72 Charger, (exc. SE) - 10 piece..... 129.99 set
MM8283	1972 Charger SE - 12 piece..... 174.99 set

Coronet	
MB1127	1965 2 door sedan - 4 piece w/flt chrome bead..... 109.99 set
MB1128	1965 2 door hardtop - 4 piece w/flt chrome bead..... 109.99 set
MB1129	1965 2 door hardtop - 4 piece w/flt chrome bead..... 109.99 set
MB1132	1966-67 2 door sedan - 8 piece..... 109.99 set
MB1133	1966-67 2 door sedan - 4 piece..... 69.99 set
MB1134	1966-67 convertible - 8 piece..... 119.99 set
MB1135	1966-67 convertible - 4 piece..... 64.99 set
MB1138	1966-70 4 door sedan, fronts - 4 piece..... 99.99 set
MB1139	1966-70 4 door wagon - 8 piece..... 114.99 set
MB1140	1968 convertible - 8 piece..... 109.99 set
MB1141	1968 convertible - 4 piece..... 89.99 set
MB1147	1968-70 2 door hardtop - 8 piece..... 109.99 set
MB1148	1968-70 2 door hardtop - 4 piece..... 89.99 set
MB1142**	1968-70 2 door coupe - 4 pc. outer w/pop out window..... 99.99 set
MB1143	1969-70 convertible - 8 piece..... 109.99 set
MB1144	1969-70 convertible - 4 piece..... 64.99 set

Dart	
MB1295	1962 2 door hardtop - 4 piece..... 99.99 set
MB1296	1962 2 door sedan - 4 piece..... 99.99 set
MB1297	1962 4 door sedan - 8 piece..... 99.99 set

Fury	
MB1155	1962 convertible - 8 piece..... 99.99 set
MB1295	1962 2 door hardtop - 4 piece..... 99.99 set
MB1296	1962 2 door sedan - 4 piece..... 99.99 set
MB1127	1963 2 door sedan, w/flt chrome bead - 4 piece..... 109.99 set
MB1128	1964 2 door hardtop w/flt chrome bead - 4 piece..... 109.99 set
MB1129	1964 2 door hardtop w/flt chrome bead - 4 piece..... 109.99 set
MB1130	1964 2 door sedan - 4 piece..... 99.99 set
MB1156	1963-64 convertible - 4 piece..... 99.99 set

GTX Satellite	
MB1134	1967 convertible - 8 piece..... 119.99 set
MB1135	1967 convertible - 4 piece..... 64.99 set
MB1136	1967 2 door hardtop - 8 piece..... 114.99 set
MB1137	1967 2 door hardtop - 4 piece..... 79.99 set
MB1146	1968 convertible - 8 piece..... 119.99 set
MB1149	1968 convertible - 4 piece..... 79.99 set
MB1151	1968-70 2 door hardtop - 8 piece..... 119.99 set
MB1152	1968-70 2 door hardtop - 4 piece..... 89.99 set
MB1153	1969-70 convertible - 8 piece..... 104.99 set
MB1154	1969-70 convertible - 4 piece..... 79.99 set

Road Runner	
MB1142**	1968-70 2 door coupe, w/pop out window - 4 pc. outer..... 99.99 set
MB1151	1968-70 2 door hardtop - 8 piece..... 119.99 set
MB1152	1968-70 2 door hardtop - 4 piece..... 89.99 set
MB1153	1969-70 convertible - 8 piece..... 104.99 set
MB1154	1969-70 convertible - 4 piece..... 79.99 set
MM8286	1973-74 2 door - 10 piece..... 129.99 set

E-Body

Barracuda	
MES22	1970 hardtop - 8 piece..... 154.99 set
MES23	1970 hardtop - 4 piece..... 94.99 set
MES24	1970 convertible - 8 piece..... 139.99 set
MES25	1970 convertible - 4 piece..... 74.99 set
MES26	1971-74 hardtop - 8 piece..... 154.99 set
MES27	1971-74 hardtop - 4 piece..... 89.99 set
Challenger	
MES15	1970 hardtop - 8 piece..... 149.99 set
MES16	1970 hardtop - 4 piece..... 79.99 set
MES24	1970 convertible - 8 piece..... 139.99 set
MES18	1970 convertible - 4 piece..... 84.99 set
MES21	1971 convertible - 4 piece..... 159.99 set
MES19	1971-74 hardtop - 8 piece..... 154.99 set
MES20	1971-74 hardtop - 4 piece..... 89.99 set

1968-70 B-Body

Door Window Weatherstrip Plug

Door window weatherstrip plug for 1968-

70 Belvedere, Coronet, Charger, Road

Runner, Superbird and Satellite models.

This is the fuzzy coated piece that plugs

into the inner door at the end of the window weatherstrip.

MB1268 1968-70 14.99 pr



Weatherstrip



MB1290

1962-76 Roof Rail Weatherstrip

Seal doors properly and keep rain and weather from entering the passenger compartment with these replacement roof rail weatherstrips for 1962-76 Mopar A, B and E-Body models.

Note: *Includes heavier seal. **Models without pop-out quarter windows. *mb* = molded ends. *B-Body* coupes have a center post and pop-out quarter windows.

A-Body

Dart				
MA1153	1963-66	convertible	69.99	set
MA9825	1964-65	2 dr hrdtp	154.99	pr
MA9826	1967-72	2 dr, exc fastback	39.99	pr
MA9828*	1973-76	hrdtp	84.99	pr
MA1154	1967-69	convertible	194.99	set
Barracuda				
MA9829B	1964-66	2 dr hrdtp	164.99	pr
MA9829A	1964-66	2 dr hrdtp	69.99	pr
MA9826	1967-69	2 dr coupe	39.99	pr
MA9830	1967-69	2 dr fastbk/notchbk	64.99	pr
MA1154	1967-69	convertible	194.99	set
Duster				
MA9827	1970-72	all	84.99	pr
Scamp				
MA9826	1971-72	2 dr hrdtp	39.99	pr
Valiant				
MA1153	1963-66	convertible	69.99	set
MA9826**	1967-69	hrdtp	39.99	pr
MA9828**	1973-76	hrdtp	84.99	pr

B-Body

Dart				
MB2233	1962	convertible	94.99	set
Polar/Fury				
MB2233	1963-64	convertible	94.99	set
Barracuda				
MB1839	1966-67	2 dr hrdtp	69.99	pr
MB1290	1968-70	2 dr hrdtp	38.99	pr
MB1291	1968-70	2 dr with post	64.99	pr
Charger				
MB1292	1966-67	2 dr fastback	115.99	pr
MB1290	1968-70	2 dr hrdtp	38.99	pr
MB1293	1971-74	2 dr hrdtp, exc SE	69.99	pr
MB1294	1973-74	2 dr hrdtp, SE	79.99	pr
Coronet				
MB1289	1965	2 dr hrdtp	69.99	pr
MB1839	1966-67	2 dr hrdtp	69.99	pr
MB1290	1968-70	2 dr hrdtp	38.99	pr
MB1291	1968-70	2 dr with post	64.99	pr
Satellite				
MB1289	1965	2 dr hrdtp	69.99	pr
MB1839	1966-67	2 dr hrdtp	69.99	pr
MB1293	1971	2 dr hrdtp	38.99	pr
MB1293	1971-74	2 dr hrdtp	69.99	pr
GTx				
MB1839	1967	2 dr hrdtp	69.99	pr
MB1290	1968-70	2 dr hrdtp	38.99	pr
MB1293	1971	2 dr hrdtp	69.99	pr
MB1740*	1967-70	convertible	199.99	set
Road Runner				
MB1291	1968-70	2 dr with post	64.99	pr
MB1290	1968-70	2 dr hrdtp	38.99	pr
MB1293	1971	2 dr hrdtp	69.99	pr
MB1293	1968-70	convertible	199.99	set
Super Bee				
MB1291	1968-70	2 dr with post	64.99	pr
MB1290	1968-70	2 dr hrdtp	38.99	pr
MB1293	1971	2 dr hrdtp	69.99	pr
E-Body				
Barracuda				
ME513	1970	hrdtp, molded ends	38.99	pr
ME514	1971-74	hrdtp, molded ends	44.99	pr
Challenger				
ME513	1970	hrdtp	38.99	pr
ME514*	1971-74	hrdtp, molded ends	44.99	pr



MB1271

1966-76 Door Weatherstrip

Door seal weatherstrip for various 1966-76 A, B and 1970-74 E-Body models. Includes installation clips and screws where applicable.

Note: *Four door sedan sets only includes weatherstrip for front doors.

A-Body

Dart				
MA9816	1967-69	2 door sedan	79.99	pr
MA9817	1967-72	2 door coupe	64.99	pr
MA9818	1973	2 door hardtop	89.99	pr
Barracuda				
MA9817	1967-69	2 door fastback	64.99	pr
MA9817	1967-69	2 door coupe	64.99	pr
Duster				
MA9817	1970-72	2 door hardtop	64.99	pr
MA9818	1973-76	2 door hardtop	89.99	pr
Scamp				
MA9817	1971-72	2 door hardtop	64.99	pr
MA9818	1973-76	2 door hardtop	89.99	pr
Valiant				
MA9816	1967-69	2 door sedan	79.99	pr
MA9817	1967-69	2 door hardtop	64.99	pr

B-Body

Beldere				
MB1269	1966-67	2 door sedan	99.99	pr
MB1270	1966-67	2 door hard/conv.	74.99	pr
MB1742*	1966-70	4 door sedan	149.99	pr
MB1271	1968-70	2 door hardtop	69.99	pr
Charger				
MB1270	1966-67	2 door hardtop	74.99	pr
MB1271	1968-70	2 door hardtop	69.99	pr
MB1272	1971-74	2 door hardtop	69.99	pr
Coronet				
MB1270	1966-67	2 door hard/conv.	74.99	pr
MB1269	1966-67	2 door sedan	99.99	pr
MB1742*	1966-70	4 door sedan	149.99	pr
MB1271	1968-70	2 door hardtop	69.99	pr
Satellite				
MB1270	1966-67	2 door hard/conv.	74.99	pr
MB1742*	1968-70	4 door sedan	149.99	pr
MB1271	1968-70	2 door hardtop	69.99	pr
MB1272	1971-74	2 door hardtop	69.99	pr
GTx				
MB1271	1968-70	2 door hardtop	69.99	pr
MB1272	1971-74	2 door hardtop	69.99	pr
Road Runner				
MB1271	1968-70	2 door hardtop	69.99	pr
MB1272	1971-74	2 door hardtop	69.99	pr
Super Bee				
MB1271	1968-70	2 door hardtop	69.99	pr

E-Body

ME500	1970-71	convertible	46.99	pr
ME500	1970-74	2 door hardtop	46.99	pr

1966-69 Door Weatherstrip to Panel Clip

Replacement door weatherstrip to inside panel clip for 1966-69 models. This white nylon clip is 3/8" long and secures the weatherstrip to the door. Officially licensed by Mopar as an Authentic Restoration Product.



ME2106 1966-69 .99 ea



1962-66 Colored Door Weatherstrip

Door seal weatherstrip with attached windlace. Mounts on the body at the door opening of 1962-66 Dart, Lancer and Valiant; 1962-65 Polara, 330, 440, Polara 500, Belvedere, Fury and Savoy. These seals feature the correct rubber profile and the correct color and cloth covering to match the original.

2 Door Hardtop/Convertible	MD2063 1962-66	specify color	124.99	pr
2 Door Sedan	MD2064 1962-66	specify color	154.99	pr
4 Door Sedan-Front Doors	MD2065 1962-66	specify color	134.99	pr
4 Door Sedan-Rear Doors	MD2066 1962-66	specify color	129.99	pr



1967-74 Door Jamb Rubber Seals

Rubber door jamb seals for Mopar B/E-Body models.

B-Body				
MB2239	1962	2 dr hardtop/conv.	39.99	pr
MB1320	1966-67	2 dr hrdtp/conv.	49.99	pr
MB1274	1968-70	2 door	19.99	pr
MB1319	1971-74	Plymouth 2dr hrd/pc.	44.99	pr
MB1319	1973-74	Dodge 2dr hrd/pc.	44.99	pr
E-Body				
ME501	1970-74	E-Body	34.99	pr



1963-74 Door Jamb Seal Screws

Replacement door jamb and door end seal screws for 1963-74 A, B, and E-Body cars. These Phillips head screws are black-anodized and designed to accurately replace the screws in the door jamb seals and the door end seal caps.

MP41260	1963-66	A-Body 6 pieces	2.99	set
MP41261	1966-70	B-Body 14 pieces	5.99	set
MP41262	1970-74	E-Body 16 pieces	6.99	set

3M Super Weatherstrip Adhesive

A black colored adhesive used for bonding and sealing weatherstripping to the trunk, body, and doors. This general purpose adhesive which is fast drying, waterproof, flexible (rubbery). Also resists oil, grease and solvents.



08008	5 oz. tube	black	9.99	ea
08001	5 oz. tube	yellow	8.99	ea

Weatherstrip



MB1273

1966-74 Molded Door Seal End Caps

Replacement rubber molded door seal end caps for 1966-70 Belvedere, Charger, Coronet, 1968-70 Road Runner and Satellite 2 door hardtop models. Also available for 1970-74 Barracuda and Challenger models. This molded end cap screws to the door and caps off the end of the door weatherstrip. Includes molded-in steel core where applicable.

B-Body

MB1273 1966-67 2 door models..... 54.99 pr
MB1275 1968-70 2 door models..... 29.99 pr

E-Body

ME502 1970-74 2 door models..... 29.99 pr



MA9866

1962-76 Quarter Glass Seals

Replacement quarter glass seals for 1970-76 A-Body and 1962-76 B-Body models. Help keep the weather out of the cabin by replacing the rear quarter glass seals. **A-Body With Pop Out Window**

MA9866 1970-76 2 door..... 87.99 pr

B-Body With Pop Out Window

MB1158 1962-65 LH wagon, with trim... 79.99 ea
MB1183 1962-65 RH wagon, with trim... 79.99 ea
MB1159 1968-70 Super Bee..... 79.99 pr
MB1160 1968-70 Belvedere..... 79.99 pr



MA9863

ME529

1966-74 Quarter Window Vertical Seals

Replacement quarter window vertical seals that install on the side window glass and seal the area between the side window and the quarter window.

A-Body

MA9863 1967-69 Barracuda hardtop... 11.99 pr
MD1611 1967-69 Barracuda fastback... 16.99 pr
MD1610 1967-69 Barracuda conv..... 15.99 pr
MD1610 1967-72 Dart hardtop/conv..... 15.99 pr

B-Body

MD1610 1966-67 2 door hardtop/conv 15.99 pr
MD1611 1968-70 2 door hardtop..... 16.99 pr
MD1610 1967-70 convertible..... 15.99 pr
MB1157 1971-74 2 door hardtop..... 31.99 pr

E-Body

ME529 1970 all, (early 1970)..... 24.99 pr
ME530 1970-74 all, (late 1970)..... 24.99 pr

New!



MP41202

1962-76 Rear Window Weatherstrip

Keep water out of the rear of the cabin and help prevent rust by replacing cracked or weathered original rear window weatherstrip.

A-Body

Dart
MP41201 1963..... 334.99 ea
MP41202 1967-76 2 dr ht w/vinyl top... 239.99 ea
MA9809 1965-66 2 dr hardtop/edan... 197.99 ea
MP41203 1968-71 2/4 dr sedan..... 239.99 ea
MA9810 1968-76 ht exc. Dart Sport... 78.99 ea

Dart Sport/Duster/Demon

MA9811 1971-76 2 dr hardtop..... 94.99 ea

Barracuda

MA9812 1964-66 2 dr fastback..... 79.99 ea
MP41204 1967 fastback..... 299.99 ea
MA9813 1968-69 2 dr fastback..... 94.99 ea
MA9814 1968-69 2 dr notch coupe..... 209.99 ea

Valiant/Scamp

MP41205 1963-65 exc conv/wagon..... 329.99 ea
MP41202 1967-76 2 dr ht w/vinyl top... 239.99 ea
MA9810 1968-76 2 dr hardtop..... 78.99 ea
MP41206 1968-69 2 dr sedan..... 294.99 ea
MP41206 1968-73 4 dr sedan..... 294.99 ea

B-Body

Do not re-use weathered rear window rubber gaskets. Replace them with quality weatherstrips for a secure seal and longer life.

Dart

MB1262 1962 2/4 dr hardtop/sedan 69.99 ea

Belvedere

MB1262 1962 2/4 dr hardtop/sedan 69.99 ea
MB1263 1963 2/4 dr hdtp/sdn..... 69.99 ea
MB1264 1964-65 2/4 dr sedan..... 69.99 ea
MB1265 1964-65 2 dr hardtop..... 65.99 ea
MB1266 1966-67 2 dr hardtop..... 198.99 ea
MB1267 1966-67 2/4 dr sedan..... 202.99 ea

Charger

MB1685 1966-67 w/o vinyl roof..... 171.99 ea

Coronet

MB1265 1964-65 2 dr hardtop..... 65.99 ea
MB1264 1964-65 2/4 dr sedan..... 69.99 ea
MB1266 1966-67 2 dr hardtop..... 198.99 ea
MB1267 1966-67 2/4 dr sedan..... 202.99 ea

Fury

MB1262 1962 2/4 dr hdtp/sedan..... 69.99 ea

Satellite

MB1265 1965 2 dr hardtop..... 65.99 ea
MB1266 1966-67 2 dr hardtop..... 198.99 ea



MA9808 detail

1970-76 A-Body Rear Window Lock Strip

Replacement rear window lock strip. Mounts to the rear window and helps secure the rear window molding to the window glass.

Dart Sport/Demon/Duster

MA9808 1970-76 2 door hdt, black... 9.99 ea

New!



MD2096



MD2097



MD2097 detail



MB1181



MB1181 detail

1963-76 Trunk Weatherstrip

Replacement trunk weatherstrip for various 1963-76 A, B and E-Body models.

A-Body

Dart-2 Door Hardtop
MD2096 1963-73 early '73 - exc. sport 18.99 ea
MD2096 1971-72 Demon..... 18.99 ea
MD2097 1973-76 late '76 - exc. sport... 24.99 ea

Barracuda

MD2096 1964-69 fastback..... 18.99 ea

MD2096 1967-69

coupe..... 18.99 ea

Duster

MD2096 1970-74 hardtop..... 18.99 ea

Scamp

MD2096 1971-74 all..... 18.99 ea

Valiant

MD2096 1964-73 early '73 - all..... 18.99 ea

MD2097 1973-76 late '76 - all..... 24.99 ea

B-Body

Belvedere

MD2096 1964-67 all..... 18.99 ea

MB1977 1968-69 all..... 29.99 ea

MB1978 1970

all..... 29.99 ea

Charger

MB1181 1966-67 hardtop..... 29.99 ea

MB1182 1968-70 hardtop..... 14.99 ea

MD2097 1971-74 hardtop..... 24.99 ea

Coronet

MD2096 1965-67 all..... 18.99 ea

MB1979 1968-69 all..... 29.99 ea

MB1978 1970 2 door hardtop..... 29.99 ea

Satellite

MD2096 1965-67 all..... 18.99 ea

MB1977 1968-69 all..... 29.99 ea

MB1978 1970 all..... 29.99 ea

MD2097 1972-74 all..... 24.99 ea

GTX

MB1977 1968-69 all..... 29.99 ea

Road Runner

MB1977 1968-69 all..... 29.99 ea

MB1978 1970 all..... 29.99 ea

E-Body

Challenger

MD2096 1970-73 early '73 - hardtop... 18.99 ea

MD2096 1970-71 convertible..... 18.99 ea

ME528 1973-74 late '74 - hardtop... 24.99 ea

Barracuda

MD2096 1970-73 early '73 - hardtop... 18.99 ea

MD2096 1970-71 convertible..... 18.99 ea

MD2097 1973-74 late '74 - hardtop... 24.99 ea

Weatherstrip/Rubber Stoppers



1962-71 Convertible Top Weatherstrip Sets

MA9877

Replacement convertible top weatherstrip sets for various 1962-71 models. Available with and without header seal. Officially licensed as a Mopar Authentic Restoration Product.

A-Body			
MA1153	1963-66	6 pc. w/o header seal	69.99 set
MA9877	1963-66	7 pc. w/header seal	119.99 set
MD2116	1967-69	7 pc. w/header seal	109.99 set
B-Body			
MB2233	1962-65	6 pc. w/o header seal	94.99 set
MB2234	1962-65	7 pc. w/header seal	124.99 set
MD2116	1966-70	7 pc. w/header seal	109.99 set
E-Body			
ME1605	1970-71	7 pc. w/header seal	134.99 set



MA9886

1966-71 Convertible Pillar Post Weatherstripping

Replacement pillar post weatherstripping for various 1966-71 convertible models. These seals install on the A-pillar where the door vent window meets the windshield.

A-Body			
MA9886	1967-69	Barracuda	137.99 pr
MA9886	1967-69	Dart	137.99 pr
B-Body			
MB1176	1966-70	all	56.99 pr
E-Body			
ME1607	1970-71	all	78.99 pr

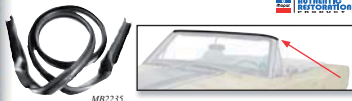

MB2235

1962-71 Convertible Top Header Seals

Replacement convertible top headers for various 1962-71 models. The seal installs along the top of the windshield where the convertible top meets the windshield. Officially licensed as a Mopar Authentic Restoration Product.

MA9882	1963-66	A-Body	54.99 ea
MD2117	1967-69	A-Body	53.99 ea
MB2235	1962-65	B-Body	59.99 ea
MD2117	1966-70	B-Body	53.99 ea
ME1606	1970-71	E-Body	58.99 ea



1966-87 Convertible Top Front Bow Retainer

Replacement convertible top front bow retainer for Mopar B-Body convertible models. MB1175 1966-67 B-Body 34.99 ea



1962-76 Individual Rubber Bumpers

Rubber bumpers for various Mopar vehicles. Available are the door bumpers, hood side bumpers, hood adjust bumpers, ash tray bumpers, glove box bumpers, trunk bumpers, fuel door bumpers, license plate bumpers. Contents and quantity may vary by application.

Door Bumper			
MD2067	1962-72	all, 5/8" long x 3/4" high x 1/2" wide, OER*	1.99 ea
MD2068	1972-79	all, 5/8" wide	1.99 ea
MD2069	1971-76	all, 5/8" wide	2.99 ea
Ash Tray Bumper			
MB1281	1962-70	B-Body, 9/16" long	1.99 ea
ME509	1970-74	E-Body, 7/8" long, 1/2" OD	1.99 ea
Glove Box Bumper			
MD2070	1962-70	all, 1/2"	1.99 ea
MD2071	1962-74	all	1.99 ea
ME510	1970-74	E-Body	2.99 ea
Fuel Door Bumper			
ME510	1970-74	E-Body	2.99 ea
License Plate Bumper			
MD2072	1960-70	7/16" OD, fits 1/4" hole	1.99 ea
MD2073	1968-74	5/8" OD, 5/8" high	1.99 ea
Hood Side Bumper			
MB1282	1962-64	B-Body	2.99 ea
MD2074	1962-65	B, E-Body	2.99 ea
MA9822	1963-66	Barracuda, Dart, Valiant	2.99 ea
MB1283	1964-65	B-Body	2.99 ea
MA9823	1964-66	A-Body, wide slot	4.99 ea
MB1284	1966-67	B-Body	1.99 ea
MB1285	1968-71	B-Body	2.99 ea
MD2075	1968-74	A, B, E-Body	1.99 ea
MD2074	1968-74	B, E-Body	2.99 ea
MD2076	1970-74	B, E-Body, rear center hood, 15/16" OD x 1-1/8"	4.99 ea
ME511	1970-74	Barracuda, hood front bumper	2.99 ea
ME512	1970-74	Challenger, hood front bumper	2.99 ea
MA9824	1971-74	Dart, Duster, Scamp, Valiant	2.99 ea
Hood Adjust Bumpers			
MD2077	1962-76	1-3/16" rubber OD, 1-1/4" x 5/16"	4.99 ea
MD2078	1962-76	1-1/4" rubber OD, 1-1/4" x 1/2"	2.99 ea
MD2079	1964-66	1" rubber OD, 1-3/4" x 5/16"	4.99 ea
MD2080	1964-66	1-1/8" rubber OD, 2-1/8" x 5/16"	4.99 ea
Trunk Bumpers			
MD2074	1962-65	B, E-Body	2.99 ea
MB1286	1963	Belvedere, 5/8" OD x 1-3/16"	1.99 ea
MB1286	1964	Polara, 5/8" OD x 1-3/16"	1.99 ea
MD2081	1966-74	A, B, E-Body	1.99 ea
MD2076	1968	B, E-Body, 15/16" OD x 1-1/8"	4.99 ea
MB1287	1968-72	Belvedere/Coronet/Road Runner/Satellite	2.99 ea
MD2075	1968-74	A, B, E-Body	1.99 ea
MD2074	1968-74	B, E-Body	2.99 ea

1963-71 Convertible Door Alignment Wedges

Door alignment wedges for 1963-71 Dodge and Plymouth convertible models. Set includes two wedges with correct mounting screws.

MD2082	1963-71	all convertible	39.99 pr
--------	---------	-----------------	----------

Weatherstrip/Rubber Stoppers



MB1277

1966-74 Rubber Bumper Sets

Complete rubber bumper sets for various Mopar vehicles. Sets include door bumpers, hood side bumpers, hood/adjay bumpers, ashtray bumpers, glove box bumpers, trunk bumpers, fuel door bumpers, rear cowl bumpers, license plate bumpers. Contents and quantity may vary by model and application.

Dodge

A-Body	Year	Model	Price
MA9819	1967-70	Dart	26.99 set
MA9820	1971	Dart, Demon	32.99 set
MA9819	1972-74	Dart	26.99 set

B-Body	Year	Model	Price
MB1276	1966-67	Charger, Coronet	24.99 set
MB1277	1968-70	Coronet, Super Bee	29.99 set
MB1278	1968-70	Charger	34.99 set
MB1279	1971	all	34.99 set
MN1785	1973-74	all	39.99 set

E-Body	Year	Model	Price
ME503	1970	Challenger	29.99 set
ME504	1971	Challenger	29.99 set
ME505	1972-74	Challenger	29.99 set

Plymouth

A-Body	Year	Model	Price
MA9819	1967-70	all	26.99 set
MA9820	1971	all	32.99 set
MA9821	1972-74	all	32.99 set

B-Body	Year	Model	Price
MB1280	1968-70	all	24.99 set
MB1279	1971	all	34.99 set
MN1784	1973-74	all	39.99 set

E-Body	Year	Model	Price
ME506	1970	Barracuda	29.99 set
ME507	1971	Barracuda	29.99 set
ME508	1972-74	Barracuda	29.99 set

New!



Made in USA

MB192055

1966-74 Headlamp Splash Shields

These replacement headlamp splash shields are manufactured out of masticated rubber, with mounting hardware included. Made in USA.

A-Body	Year	Model	Price
MAR2015	1967-69	Barracuda	19.99 pr
MAR2022	1967-69	Dart	19.99 pr
MAR2019	1967-69	Valiant	19.99 pr
MAR20159	1970-76	Duster	19.99 pr

B-Body	Year	Model	Price
MB192051	1966-67	Charger	24.99 pr
MB184565	1968-69	Charger	24.99 pr
MB192052	1970	Charger	24.99 pr
MB192053	1971-74	Charger	24.99 pr
MB184604	1966-67	Coronet	24.99 pr
MB192050	1968-69	Coronet	24.99 pr
MB184605	1970	Coronet	24.99 pr
MB192054	1966-67	Belvedere	24.99 pr
MB192055	1968-69	all Plymouth	24.99 pr
MB192056	1970	all Plymouth	24.99 pr
MB192057	1971-72	all Plymouth	24.99 pr

New!



MAR22084A

MAR22088A

1963-74 Complete Splash Shield Sets

Reproduction splash shield sets for various 1963-74 models. Manufactured to look and fit like the originals, these masticated rubber splash shield sets include the pieces to restore your vehicle. Stainless mounting clips are included with all sets. Made in USA.

A-Body

Model	Year	Model	Price
Barracuda	1964-65	auto	79.99 set
MAR22084A	1964-65	manual	68.99 set
MAR22092A	1966	auto	109.99 set
MAR22092M	1966	manual	97.99 set
MAR22086A	1967-69	auto	64.99 set
MAR22086M	1967-69	manual	52.99 set

Dart

Model	Year	Model	Price
MAR22087A	1963-65	auto	76.99 set
MAR22087M	1963-65	manual	64.99 set
MAR22088A	1966	auto	109.99 set
MAR22088M	1966	manual	97.99 set
MAR22089A	1967-69	auto	64.99 set
MAR22089M	1967-69	manual	52.99 set
MAR22090A	1970-72	auto	59.99 set
MAR22090M	1970-72	manual	49.99 set

Demon/Duster/Scamp

Model	Year	Model	Price
MAR22091A	1970-72	auto	59.99 set
MAR22091M	1970-72	manual	49.99 set

B-Body

Model	Year	Model	Price
Belvedere	1963	auto	89.99 set
MB281003A	1963	manual	79.99 set
MB281004A	1963	auto	89.99 set
MB281004M	1964	manual	79.99 set
MB281005A	1965	auto	89.99 set
MB281005M	1965	manual	79.99 set
MB281006A	1966	auto	109.99 set
MB281006M	1966	manual	99.99 set
MB281007A	1967	auto	104.99 set
MB281007M	1967	manual	94.99 set
Dodge 330/440/Polara	1963	auto	89.99 set

Dodge 330/440/Polara

Model	Year	Model	Price
MB281008A	1963	auto	89.99 set

B-Body - Continued

Model	Year	Model	Price
Dodge 330/440/Polara	1963	auto	89.99 set
MB281008M	1963	manual	79.99 set

Coronet

Model	Year	Model	Price
MB281009A	1964	auto	89.99 set
MB281009M	1964	manual	79.99 set
MB281010A	1965	auto	89.99 set
MB281010M	1965	manual	79.99 set

Charger

Model	Year	Model	Price
MB281011A	1966	auto	109.99 set
MB281011M	1966	manual	99.99 set
MB281012A	1967	auto	104.99 set
MB281012M	1967	manual	94.99 set
MB281013A	1968-69	auto	84.99 set
MB281013M	1968-69	manual	74.99 set
MB281014A	1970	auto	84.99 set
MB281014M	1970	manual	74.99 set

Charger

Model	Year	Model	Price
MB281015A	1966	auto	109.99 set
MB281015M	1966	manual	99.99 set
MB281016A	1967	auto	104.99 set
MB281016M	1967	manual	94.99 set
MB281017A	1968-69	auto	84.99 set
MB281017M	1968-69	manual	74.99 set
MB281018M	1970	auto	74.99 set
MB281019	1971-72	all	39.99 set
MB281020	1973-74	all	44.99 set

Road Runner

Model	Year	Model	Price
MB281022A	1968-69	auto	79.99 set
MB281022M	1968-69	manual	69.99 set
MB281023A	1970	auto	74.99 set
MB281023M	1970	manual	64.99 set

Satellite

Model	Year	Model	Price
MB281021	1971-72	all	59.99 set

New!



Made in USA

MB184601

1966-74 Inner Fender Splash Shields

Replacement inner fender splash shields for all 1966-74 Mopar B and E-Body models. These shields are mounted to the inner fenders, are manufactured out of masticated rubber and includes stainless mounting hardware. Made in USA.

Model	Year	Model	Price
MB184600	1966-70	B-Body	19.99 pr
MB184601	1971-72	B-Body	19.99 pr
MB184602	1973-74	B-Body	19.99 pr
ME861021	1970	E-Body	19.99 pr
ME861022	1971-74	E-Body	19.99 pr



Made in USA

MB184603

1971-72 B-Body Bumper Shields

Replacement front bumper bracket splash shields for all 1971-72 Plymouth B-Body models. Manufactured out of masticated rubber with mounting hardware included. Made in USA.

Model	Year	Model	Price
MB184603	1971-72	Plymouth B-Body	13.99 pr



Made in USA

MB184601

1966-74 Inner Fender Splash Shields

Replacement inner fender splash shields for all 1966-74 Mopar B and E-Body models. These shields are mounted to the inner fenders, are manufactured out of masticated rubber and includes stainless mounting hardware. Made in USA.

Model	Year	Model	Price
MB184600	1966-70	B-Body	19.99 pr
MB184601	1971-72	B-Body	19.99 pr
MB184602	1973-74	B-Body	19.99 pr
ME861021	1970	E-Body	19.99 pr
ME861022	1971-74	E-Body	19.99 pr

Body Gaskets



MAR20168



1967-68 Barracuda Hood Insert Gaskets

Replacement hood insert gaskets for all 1967-68 Barracuda models. These gaskets are manufactured out of ABS plastic and are a great way to replace your factory originals. Made in the USA.

MAR20168 1967..... 16.99 pr
MAR20169 1968..... 11.99 pr



MB184596



1970-72 N96 Fresh Air Door Seals

Replacement fresh air door to hood seal for 1970-72 Road Runner and 1969-72 Charger models equipped with the N96 option. This seal attaches to the recess in the hood to protect the paint from door vibration. Made in the USA.

MB184596 1970 Road Runner..... 11.99 ea
MB184597 1971-72 Road Runner..... 11.99 ea
MB184596 1971-72 Charger..... 11.99 ea



MB184598



1969-72 N96 Fresh Air Box Seals

Replacement fresh air box to hood seal for 1970-72 Road Runner and 1969-72 Dodge models equipped with the N96 option. This piece seals the air grabber box to the underside of the hood. Made in the USA.

MB184598 1970 Road Runner..... 11.99 ea
MB184599 1971-72 Road Runner..... 9.99 ea
MB184598 1971-72 Charger..... 11.99 ea
MB192049 1969-70 Coronet/Super Bee 14.99 set



1970 Road Runner Hood Call-Out Gaskets

Replacement hood call-out and indicator gaskets for 1970 Road Runner models. Laser cut to the correct shape for a proper fit. Made in the USA.

MB184595 1970..... 13.99 set



1970-71 Challenger R/T Hood Scoop Gaskets

Replacement hood scoop gaskets for 1970-71 Challenger models equipped with an R/T style hood. These gaskets are cut to the correct shape and will seal the area between the scoops and the hood. Made in the USA.

ME861020 1970-71..... 9.99 pr



MAR20218



MD600328



1966-76 Firewall Gasket Sets

These replacement firewall gasket sets for various 1966-76 models are manufactured to original specifications for a proper fit and appearance. Each set comes with a variety of firewall gaskets including the wiper motor, bulkhead connector, wiper pivot, steering column, master cylinder, and more. Made in the USA.

A-Body	
Without Air Conditioning	
MAR20214 1967-72 all.....	34.99 set
MAR20215 1973-74 all.....	34.99 set
MAR20216 1975-76 all.....	34.99 set
With Air Conditioning	
MAR20217 1967-72 all.....	29.99 set
MAR20218 1973-74 all.....	29.99 set
MAR20219 1975-76 all.....	29.99 set

B-Body	
Without Air Conditioning	
MB184607 1966-70 all.....	34.99 set
MD600327 1971-74 all.....	34.99 set
With Air Conditioning	
MB184608 1966-70 all.....	44.99 set
MD600328 1971-74 all.....	34.99 set

E-Body	
Without Air Conditioning	
MD600327 1970-74 all.....	34.99 set
With Air Conditioning	
MD600328 1970-74 all.....	34.99 set

MB192058

MB184549

MB184552



1966-70 B-Body Quarter Extension Gaskets

Replacement quarter extension gaskets for various 1966-70 B-Body models. Replace your damaged originals with these quality pieces. Made in the USA.

Dodge	
MB192058 1968-70 Charger.....	14.99 pr
MB192059 1966 Coronet.....	11.99 pr
MB184546 1967 Coronet, 4-piece.....	23.99 set
MB184547 1968 Coronet.....	34.99 pr
MB184548 1969 Coronet.....	14.99 pr
MB184549 1970 Coronet.....	14.99 pr
Plymouth	
MB184553 1966 Belvedere.....	14.99 pr
MB184550 1967 Belvedere.....	14.99 pr
MB184551 1968 Road Runner.....	14.99 pr
MB184552 1969 Road Runner.....	19.99 pr



MB184567



ME861014



1967-71 Convertible Top Seal Sets

Replacement convertible top seal sets for various 1967-71 models. These sets install between the top and its attachment points and include foam tape for installation under the windshield cap. Made in USA.

MAR20170 1967-69 A-Body..... 11.99 set
MB184567 1967-69 B-Body..... 11.99 set
ME861014 1970-71 E-Body..... 11.99 set

Body Gaskets



MA147100 dentail



MA147100



Installation detail



WL208 detail

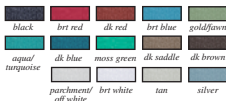

Universal Snap On Windlace by the Foot

Reproduction-style snap on flexible trim, double lip style windlace. Often used to seal interior rear door jamb edges to sill plates and much more. Featuring authentic vinyl grain texture. Unique gripping power and rapid application, this flexible vinyl trim is ideal for classic car applications. Available in a variety of colors. Sold by the foot

WL200	black	2.99 ft	WL207	moose green	2.99 ft
WL201	bright red	2.99 ft	WL208	tan	2.99 ft
WL202	dark red	2.99 ft	WL209	silver	2.99 ft
WL203	bright blue	2.99 ft	WL210	dark saddle	2.99 ft
WL204	gold/fawn	2.99 ft	WL211	dark brown	2.99 ft
WL205	gold/turquoise	2.99 ft	WL212	parchment/off white	2.99 ft
WL206	dark blue	2.99 ft	WL213	bright white	2.99 ft

1966-69 2-Door Sedan Windlace

Exact replacement door jamb windlace for 1966-69 A-body and B-Body 2-door sedan models, including Dart, Barracuda, Valiant, Coronet, Belvedere, and Satellite models. Color keyed to match your interior, includes enough windlace for two doors jamba.

A-Body

MA147100	1967-69	black	69.99
MA147200	1969	white	69.99
MA147202	1967-69	pearl white	69.99
MA147520	1967-68	metallic red	69.99
MA147526	1968	metallic maroon	69.99
MA147528	1968-69	red	69.99
MA147430	1967-68	metallic green	69.99
MA147620	1967	copper	69.99
MA147320	1967-68	metallic navy	69.99
MA147630	1967-69	gold	69.99
MA147330	1968-69	dk metallic blue	69.99
MA147432	1968-69	lt metallic blue	69.99
MA147650	1969	lt metallic green	69.99
MA147338	1969	saddle	69.99
MA147434	1969	dk metallic green	69.99
MA147154	1969	charcoal	69.99

B-Body

MB193100	1966-67	black	109.99
MB193020	1966-67	white	109.99
MB193118	1966-67	light blue	109.99
MB193320	1966-67	navy	109.99
MB193430	1966-67	dark green	109.99
MB193520	1966-67	red	109.99
MB193630	1966-67	gold	109.99



1967-74 Tail Lamp Bezel Gaskets

Replacement tail lamp bezel gaskets for 1967-69 Dart, 1970 Barracuda, and 1972-74 Challenger models. Manufactured in the correct gray paper, black rubber, or plastic gasket material for each respective year.

MAR20210	1967	Dart - rubber	10.99
MAR20211	1968-69	Dart - paper	8.99
ME861029	1970	Barracuda - paper	10.99
ME861032	1972-74	Challenger - plastic	10.99

New!

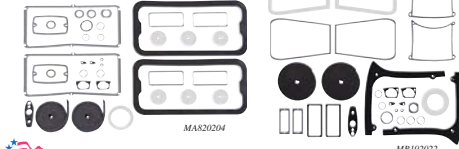

1963-76 Paint Gasket Sets

Replacement paint gasket sets for various 1963-76 Dodge and Plymouth models. These are the most correct and complete paint gasket sets available on the market. Manufactured from OEM style material and laser cut for a proper fit.

Dodge		A-Body		
MAR22064	1963	Dart	59.99	set
MAR22065	1964	Dart	64.99	set
MAR22066	1965	Dart	59.99	set
MAR22067	1966	Dart	66.99	set
MAR20190	1967	Dart	59.99	set
MAR20191	1968	Dart	69.99	set
MAR20192	1969	Dart	74.99	set
MAR20193	1970	Dart	66.99	set
MAR20194	1971	Dart	66.99	set
MAR20195	1972	Dart	59.99	set
MAR20196	1973	Dart	59.99	set
MAR20197	1974-75	Dart	54.99	set
MAR20198	1973-76	Dart Sport	49.99	set
MAR20199	1971	Demon	74.99	set
MAR20200	1972	Demon	64.99	set

Plymouth		B-Body - Continued		
MB28085	1964	Barracuda	64.99	set
MAR22060	1964-65	Barracuda	64.99	set
MAR22061	1965	Barracuda	69.99	set
MAR20201	1967	Barracuda	69.99	set
MAR20202	1968	Barracuda	79.99	set
MAR20203	1969	Barracuda	79.99	set
MAR20204	1970-71	Duster	74.99	set
MAR20205	1972	Duster	59.99	set
MAR20206	1973-76	Duster	59.99	set
MAR20207	1971	Scamp	64.99	set
MAR20208	1972	Scamp	59.99	set
MAR22062	1966	Valiant	64.99	set
MAR20209	1967	Valiant	64.99	set
MAR22063	1968	Valiant	59.99	set

B-Body

Dodge				
MB281000	1965	Coronet	64.99	set
MB281001	1965	Coronet 500	64.99	set
MB192022	1966	Coronet	69.99	set
MB192023	1967	Coronet 440	59.99	set

MB192024	1967	Coronet R/T	79.99	set
MB192025	1968	Coronet	69.99	set
MB192026	1969	Coronet/Super Bee	72.99	set
MB192027	1969	Coronet R/T	72.99	set
MB192028	1970	Coronet/Super Bee	76.99	set
MB192029	1970	Coronet R/T	76.99	set
MB192030	1966-67	Charger	69.99	set
MB192031	1968	Charger	66.99	set
MB192032	1969	Charger	89.99	set
MB192033	1970	Charger	94.99	set
MB192034	1971	Charger - base	56.99	set
MB192035	1971	Charger R/T	59.99	set
MB192036	1972	Charger - base	54.99	set
MB192037	1972	Charger Rallye	59.99	set
MB192038	1973-74	Charger	54.99	set

Plymouth

MB280991	1963	Belvedere	67.99	set
MB280992	1964	Belvedere	77.99	set
MB280993	1965	Belvedere	69.99	set
MB192039	1966	Belvedere/Satellite	66.99	set
MB192040	1967	Belvedere/Satellite	66.99	set
MB192041	1968	RdRnrr/Satellite	66.99	set
MB192042	1969	RdRnrr/Satellite	69.99	set
MB192043	1969	GTX/Sprt Satellite	69.99	set
MB192044	1970	Road Runner	69.99	set
MB192045	1970	Satellite	64.99	set
MB192046	1971	all	59.99	set
MB192047	1972	all	54.99	set
MB192048	1973-74	all	46.99	set

E-Body

ME861023	1970	Barracuda	84.99	set
ME861024	1971	Barracuda	84.99	set
ME861025	1972-74	Barracuda	67.99	set
ME861026	1970	Challenger	82.99	set
ME861027	1971	Challenger	82.99	set
ME861028	1972-74	Challenger	77.99	set

Reproduction Glass

Restorer's Choice or Standard Replacement?

Classic Industries® offers two lines of auto glass to suit the needs of your Mopar. For glass that matches the shape and contours of the originals, our Standard

Replacement line of glass is the economical way to make your Mopar look like new. For glass that goes beyond simple replacement, our officially licensed Restorer's Choice auto glass adds further authenticity in the form of correct etched Pentastar logos and specification notes (without date coding). Restorer's Choice is available as a complete set so you can "Buy the Set and Save!". Both versions are offered in your choice of tinted or clear glass.



detail of Pentastar markings



1968-76 Restorer's Choice Glass Set

Restorer's Choice glass sets for 1968-76 models are officially licensed by Mopar, feature Pentastar markings and include windshield, back window, door glass, quarter glass and vent glass when applicable.

Important: When ordering glass for A-Body models, make sure the door glass has the correct number of holes for the window track.

Note: Shipped truck freight.

A-Body	
Demon, Duster	
MM1726 1970-72 clear	949.99 set
MM1727 1970-72 tinted	949.99 set
Dart Sport, Duster	
MM1728 1973-74 clear w/5 holes	949.99 set
MM1729 1973-74 tinted w/5 holes	949.99 set
MM1730 1974-76 clear w/7 holes	949.99 set
MM1731 1974-76 tinted w/7 holes	949.99 set

B-Body	
Except Charger	
MM1732 1968-70 clear	2 dr hrdtp... 1224.99 set
MM1733 1968-70 tinted	2 dr hrdtp... 1224.99 set
MM1742 1971 clear	2 dr hrdtp... 1144.99 set
MM1743 1971 tinted	2 dr hrdtp... 1144.99 set

Charger	
MM1736 1968-70 clear	w/5 holes... 1224.99 set
MM1737 1968-70 tinted	w/5 holes... 1224.99 set
MM1738 1971 clear	w/7 holes... 1144.99 set
MM1739 1971 tinted	w/7 holes... 1144.99 set

Dodge	
MM1734 1968-70 clear	2 dr sdn... 1224.99 set
MM1735 1968-70 tinted	2 dr sdn... 1224.99 set

Plymouth	
MM1740 1968-70 clear	2 dr sdn... 1224.99 set
MM1741 1968-70 tinted	2 dr sdn... 1224.99 set

E-Body	
Barracuda	
MM1744 1970-74 clear	hardtop ... 1144.99 set
MM1745 1970-74 tinted	hardtop ... 1144.99 set

Challenger	
MM1746 1970-74 clear	hardtop ... 1144.99 set
MM1747 1970-74 tinted	hardtop ... 1144.99 set

Convertible	
MM1748 1970-71 clear	1089.99 set
MM1749 1970-71 tinted	1089.99 set



1961-76 Windshield Glass

These windshields are tempered laminate safety glass, designed to protect from road debris in the event of a crash. Available in your choice of clear or with a green tinted band at the top. Each glass is professionally packed with extra care to prevent damage during shipping.

Note: Shipped truck freight.

Restorer's Choice Glass	
A-Body	
Barracuda, Dart	
MM1622 1967-76 clear	189.99 ea
MM1623 1967-76 tinted	189.99 ea
Dart Sport, Demon, Duster	
MM1624 1970-76 clear	204.99 ea
MM1625 1970-76 tinted	204.99 ea

B-Body	
All	
MM1626 1962-63 clear	224.99 ea
MM1627 1962-63 tinted	224.99 ea
MM1628 1964-65 clear	224.99 ea
MM1629 1964-65 tinted	224.99 ea
MM1630 1966-67 clear	hrdtp/convt 224.99 ea
MM1631 1966-67 tinted	hrdtp/convt 224.99 ea
MM1634 1971-74 clear	224.99 ea
MM1635 1971-74 tinted	224.99 ea

Convertible	
MM1630 1968-70 clear	224.99 ea
MM1631 1968-70 tinted	224.99 ea
MM1632 1968-70 clear	224.99 ea
MM1633 1968-70 tinted	224.99 ea

E-Body	
MM1636 1970-74 clear	all... 224.99 ea
MM1637 1970-74 tinted	all... 224.99 ea

Standard Replacement Glass

A-Body	
Lancer - 2 Door Hardtop	
MM3134 1961-62 tinted	309.99 ea
Dart - 2 Door Hardtop/Convertible	
MM3135 1963-66 tinted	309.99 ea

B-Body	
Dart - 2/4 Door Hardtop/Convertible	
MM3135 1962 tinted	309.99 ea
All Hardtop/Convertible/Sedan	
MM8342 1966-67 tinted	hrtp/convt... 189.99 ea
MM8359 1966-67 tinted	sedan... 239.99 ea



This reproduction door vent glass for all 1961-76 models feature correct contours, and are available in clear or green tinted shade.

Restorer's Choice Glass	
A-Body	
All	
MM3156C 1968-76 LH	clear... 79.99 ea
MM3156B 1968-76 RH	clear... 79.99 ea
MM3156T 1968-76 LH	tinted... 79.99 ea
MM3157T 1968-76 RH	tinted... 79.99 ea

B-Body	
2 Door	
MM1638 1968-70 LH	clear... 81.99 ea
MM1639 1968-70 RH	clear... 81.99 ea
MM1640 1968-70 LH	tinted... 81.99 ea
MM1641 1968-70 RH	tinted... 81.99 ea

Standard Replacement Glass

A-Body	
Lancer - 2 Door Hardtop	
MM3137C 1961-62 LH/RH	clear... 34.99 ea
MM3137T 1961-62 LH/RH	tinted... 34.99 ea
Dart - 2 Door Hardtop/Conv	
MM3138C 1963-66 LH/RH	clear... 34.99 ea
MM3138T 1963-66 LH/RH	tinted... 34.99 ea

All	
MM3139T 1967 LH	tinted... 81.99 ea
MM3140T 1967 RH	tinted... 81.99 ea

B-Body	
All Dart	
MM3143C 1962 LH/RH	clear... 34.99 ea
MM3143T 1962 LH/RH	tinted... 34.99 ea

2 Door	
MM8343C 1966-67 LH	clear... 81.99 ea
MM8344C 1966-67 RH	clear... 81.99 ea
MM8345T 1966-67 LH	tinted... 81.99 ea
MM8344T 1966-67 RH	tinted... 81.99 ea



1966-76 Back Window Glass

Quality reproduction back window glass for various 1966-76 A-Body, B-Body and E-Body models. Available in your choice of clear or tinted.

Note: Shipped truck freight.

Restorer's Choice Glass

A-Body	
Dart & Scamp - 2 Door Hardtop	
MM3164C 1967-76 clear	234.99 ea
MM3164T 1967-76 tinted	234.99 ea
Dart Sport/Demon/Duster	
MM1674 1970-76 clear	234.99 ea
MM1675 1970-76 tinted	234.99 ea

B-Body	
Charger Only	
MM1676 1968-70 clear	354.99 ea
MM1677 1968-70 tinted	354.99 ea

Except Charger	
MM1678 1968-70 clear	394.99 ea
MM1679 1968-70 tinted	394.99 ea

All	
MM1680 1971-74 clear	354.99 ea
MM1681 1971-74 tinted	354.99 ea

E-Body	
Barracuda	
MM1682 1970-74 clear	354.99 ea
MM1683 1970-74 tinted	354.99 ea

Challenger	
MM1684 1970-74 clear	339.99 ea
MM1685 1970-74 tinted	339.99 ea

Standard Replacement Glass

A-Body	
2 Door Hardtop	
MM3165 1967-72 tinted	349.99 ea

B-Body	
Charger Only	
MM8357C 1966-67 clear	284.99 ea
MM8357T 1966-67 tinted	284.99 ea

Except Charger - 2 Door Hardtop	
MM8358C 1966-67 clear	354.99 ea
MM8358T 1966-67 tinted	354.99 ea

Reproduction Glass



detail of Pentastar markings



1961-76 Reproduction Door Glass

Quality reproduction door window glass for various 1961-76 A-Body, B-Body and E-Body models. Available in your choice of clear or tinted.

Note: Shipped exercise.

Restorer's Choice Glass

Part No.	Year	Color	Application	Price
MM3162C	1968-72	LH clear	Dart - 2 door	159.99 ea
MM3163C	1968-72	RH clear	Dart - 2 door	159.99 ea
MM3162T	1968-72	LH tinted	Dart - 2 door	159.99 ea
MM3163T	1968-72	RH tinted	Dart - 2 door	159.99 ea
MM1642	1970-72	LH clear	Demon, Duster - w/6 holes	181.99 ea
MM1643	1970-72	RH clear	Demon, Duster - w/6 holes	181.99 ea
MM1644	1970-72	LH tinted	Demon, Duster - w/6 holes	181.99 ea
MM1645	1970-72	RH tinted	Demon, Duster - w/6 holes	181.99 ea
MM1646	1973-74	LH clear	Dart Sport, Duster - w/5 holes	181.99 ea
MM1647	1973-74	RH clear	Dart Sport, Duster - w/5 holes	181.99 ea
MM1648	1973-74	LH tinted	Dart Sport, Duster - w/5 holes	181.99 ea
MM1649	1973-74	RH tinted	Dart Sport, Duster - w/5 holes	181.99 ea
MM1650	1974-76	LH clear	Dart Sport, Duster - w/7 holes	181.99 ea
MM1651	1974-76	RH clear	Dart Sport, Duster - w/7 holes	181.99 ea
MM1652	1974-76	LH tinted	Dart Sport, Duster - w/7 holes	181.99 ea
MM1653	1974-76	RH tinted	Dart Sport, Duster - w/7 holes	181.99 ea

Part No.	Year	Color	Application	Price
MM1654	1968-70	LH clear	hardtop	209.99 ea
MM1655	1968-70	RH clear	hardtop	209.99 ea
MM1656	1968-70	LH tinted	hardtop	209.99 ea
MM1657	1968-70	RH tinted	hardtop	209.99 ea
MM1658	1968-70	LH clear	sedan	209.99 ea
MM1659	1968-70	RH clear	sedan	209.99 ea
MM1660	1968-70	LH tinted	sedan	209.99 ea
MM1661	1968-70	RH tinted	sedan	209.99 ea
MM1662	1971-74	LH clear	hardtop	209.99 ea
MM1663	1971-74	RH clear	hardtop	209.99 ea
MM1664	1971-74	LH tinted	hardtop	209.99 ea
MM1665	1971-74	RH tinted	hardtop	209.99 ea

Part No.	Year	Color	Application	Price
MM1666	1970-74	LH clear	hardtop	209.99 ea
MM1667	1970-74	RH clear	hardtop	209.99 ea
MM1668	1970-74	LH tinted	hardtop	209.99 ea
MM1669	1970-74	RH tinted	hardtop	209.99 ea
MM1670	1970-71	LH clear	convertible	289.99 ea
MM1671	1970-71	RH clear	convertible	289.99 ea
MM1672	1970-71	LH tinted	convertible	289.99 ea
MM1673	1970-71	RH tinted	convertible	289.99 ea

Standard Replacement Glass

Note: Please add the correct suffix for glass preference. (C=clear or T=tinted)

Part No.	Year	Color	Application	Price
MM3150	1961	LH/RH	Lancer 2 dr hardtop	64.99 ea
MM3151	1962	LH/RH	Lancer 2 dr hardtop	64.99 ea
MM3152	1963-66	LH/RH	Dart 2 dr hardtop/convertible	64.99 ea

Part No.	Year	Color	Application	Price
MM3153	1962	LH/RH	Dart 2 dr hardtop/convertible	64.99 ea
MM3154	1962	LH/RH	Dart 4 dr hardtop front	64.99 ea
MM3155	1962	LH/RH	Dart 4 dr hardtop rear	64.99 ea
MM38353	1966	LH all	2 dr hardtop/convertible	149.99 ea
MM38354	1966	RH all	2 dr hardtop/convertible	149.99 ea
MM38355	1967	LH all	2 dr hardtop/convertible	149.99 ea
MM38356	1967	RH all	2 dr hardtop/convertible	149.99 ea



3M® Super Fast Urethane

A rapid curing adhesive/sealant intended for all flush mounted and bonded windshield or back glass replacements. Provides the necessary strength for automotive glass replacement. 10 fl. oz. cartridge. 08609 21.99 ea

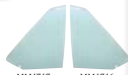

1961-76 Reproduction Quarter Glass

Quality reproduction quarter window glass for various 1961-76 A-Body, B-Body and E-Body models. Available in your choice of clear or tinted.

Restorer's Choice Glass

Part No.	Year	Color	Application	Price
MM3158C	1968-72	LH clear	Dart - 2 door	149.99 ea
MM3159C	1968-72	RH clear	Dart - 2 door	149.99 ea
MM3158T	1968-72	LH tinted	Dart - 2 door	149.99 ea
MM3159T	1968-72	RH tinted	Dart - 2 door	149.99 ea
MM1686	1970-72	LH clear	Demon/Duster	144.99 ea
MM1687	1970-72	RH clear	Demon/Duster	144.99 ea
MM1688	1970-72	LH tinted	Demon/Duster	144.99 ea
MM1689	1970-72	RH tinted	Demon/Duster	144.99 ea
MM1690	1973-76	LH clear	Dart Sport/Duster	144.99 ea
MM1691	1973-76	RH clear	Dart Sport/Duster	144.99 ea
MM1692	1973-76	LH tinted	Dart Sport/Duster	144.99 ea
MM1693	1973-76	RH tinted	Dart Sport/Duster	144.99 ea

Part No.	Year	Color	Application	Price
MM1694	1968-70	LH clear	hardtop	149.99 ea
MM1695	1968-70	RH clear	hardtop	149.99 ea
MM1696	1968-70	LH tinted	hardtop	149.99 ea
MM1697	1968-70	RH tinted	hardtop	149.99 ea
MM1698	1968-70	LH clear	sedan	149.99 ea
MM1699	1968-70	RH clear	sedan	149.99 ea
MM1700	1968-70	LH tinted	sedan	149.99 ea
MM1701	1968-70	RH tinted	sedan	149.99 ea
MM1702	1971	LH clear	Charger	149.99 ea
MM1703	1971	RH clear	Charger	149.99 ea
MM1704	1971	LH tinted	Charger	149.99 ea
MM1705	1971	RH tinted	Charger	149.99 ea

Part No.	Year	Color	Application	Price
MM1694	1968-70	LH clear	hardtop	149.99 ea
MM1695	1968-70	RH clear	hardtop	149.99 ea
MM1696	1968-70	LH tinted	hardtop	149.99 ea
MM1697	1968-70	RH tinted	hardtop	149.99 ea
MM1706	1968-70	LH clear	sedan	149.99 ea
MM1707	1968-70	RH clear	sedan	149.99 ea
MM1708	1968-70	LH tinted	sedan	149.99 ea
MM1709	1968-70	RH tinted	sedan	149.99 ea
MM1710	1971	LH clear	hardtop	149.99 ea
MM1711	1971	RH clear	hardtop	149.99 ea
MM1712	1971	LH tinted	hardtop	149.99 ea
MM1713	1971	RH tinted	hardtop	149.99 ea

Part No.	Year	Color	Application	Price
MM1714	1970-74	LH clear	Barracuda - hardtop	149.99 ea
MM1715	1970-74	RH clear	Barracuda - hardtop	149.99 ea
MM1716	1970-74	LH tinted	Barracuda - hardtop	149.99 ea
MM1717	1970-74	RH tinted	Barracuda - hardtop	149.99 ea
MM1718	1970-74	LH clear	Challenger - hardtop	149.99 ea
MM1719	1970-74	RH clear	Challenger - hardtop	149.99 ea
MM1720	1970-74	LH tinted	Challenger - hardtop	149.99 ea
MM1721	1970-74	RH tinted	Challenger - hardtop	149.99 ea
MM1722	1970-71	LH clear	convertible	179.99 ea
MM1723	1970-71	RH clear	convertible	179.99 ea
MM1724	1970-71	LH tinted	convertible	179.99 ea
MM1725	1970-71	RH tinted	convertible	179.99 ea

Standard Replacement Glass

Note: Please add the correct suffix for glass preference. (C=clear or T=tinted)

Part No.	Year	Color	Application	Price
MM3146	1961	LH/RH	Lancer 2 dr. hdtp front	64.99 ea
MM3147	1962	LH/RH	Lancer 2 dr. hardtop rear	64.99 ea
MM3148	1963-66	LH/RH	Dart 2 dr. hardtop	64.99 ea
MM3149	1963-66	LH/RH	Dart 2 dr. convertible	64.99 ea

Part No.	Year	Color	Application	Price
MM3144	1962	LH/RH	Dart hardtop	64.99 ea
MM3145	1962	LH/RH	Dart convertible	64.99 ea
MM38345	1966-67	LH	Charger	99.99 ea
MM38346	1966-67	RH	Charger	99.99 ea
MM38347	1966	LH	Coronet	99.99 ea
MM38348	1966	RH	Coronet	99.99 ea
MM38349	1967	LH	Coronet	99.99 ea
MM38350	1967	RH	Coronet	99.99 ea
MM38351	1966-67	LH	Coronet convertible	99.99 ea
MM38352	1966-67	RH	Coronet convertible	99.99 ea

Part No.	Year	Color	Application	Price
MM38347	1966	LH all	hardtop	99.99 ea
MM38348	1966	RH all	hardtop	99.99 ea
MM38349	1967	LH all	hardtop	99.99 ea
MM38350	1967	RH all	hardtop	99.99 ea
MM38351	1966-67	LH all	convertible	99.99 ea
MM38352	1966-67	RH all	convertible	99.99 ea

Grill & Hood Moldings



New!

1965 Dart Grill Moldings

Reproduction grill surround moldings for 1965 Dodge Dart models. These "candy cane" moldings are manufactured out of aluminum and polished, as original.
MP41221 1965..... 469.99 pr

New!



2949968



2949970

1970-72 Valiant, Scamp, Duster, Grill Moldings

Reproduction grill moldings for 1970-72 Valiant, Scamp, and Duster/Duster 340 models with a standard grill or 1971-72 Duster 340 models with Sharktooth/Twister grill. Manufactured from stamped aluminum as original, these moldings fit Standard or Sharktooth/Twister grills. Also available is the set of 5 grill retaining clips found along the bottom edge of these grills to secure the grill to the vehicle. Grills are not included, but sold separately. Moldings and clip sets also include Phillips head screws for installation. Officially licensed Mopar Authentic Restoration Product.
2949968 1970-72 grill molding - upper..... 129.99 ea
2949970 1970-72 grill molding - lower..... 129.99 ea
3443540 1970-72 grill retaining clips - set of 5..... 24.99 set

New!



MB2173

1968-69 Charger Grill Moldings

Grill molding sets for 1968-69 Charger models. Features correct contours and polished finish. Each set includes the necessary moldings for the grill assembly. The "T" grill molding for 1969 models is also available separately.

Complete Sets

MB2172 1968 4 piece set..... 229.99 set

MB2173 1969 7 piece set..... 389.99 set

Individual Components

MB184618 1968 2 piece set - horizontal moldings..... 119.99 pr

MB184619 1968-69 "C" moldings..... 119.99 pr

MB2174 1969 "T" molding..... 189.99 ea

MB184617 1969 4 piece set - horizontal moldings..... 119.99 set



MN1466

1968 Plymouth B-Body Grill Moldings

Reproduction factory-style reproduction grill moldings for 1968 GTX models. Each set includes both the upper and lower center moldings featuring the correct contours and bright finish to correctly replace the grill molding. Made in USA.
MN1466 1968 GTX..... 194.99 pr

1969-70 Plymouth B-Body Grill Moldings

MB2177

Grill moldings for 1969 GTX models and 1970 Road Runner and GTX models. The 1969 moldings the upper and lower center moldings. The 1970 moldings are available as a set of four moldings and include the upper, lower and the headlamp bezel moldings.

Moldings

MB2175 1969 GTX..... 144.99 pr

MB2177 1970 Road Runner/GTX..... 201.99 set

Mounting Clips

MB2176 1969 GTX..... 14.99 set

New!

1970 B-Body Lower Grill Molding

Reproduction lower grill molding for all 1970 Plymouth B-Body models. This is the molding that is installed below the grill, and features the correct stainless finish with pre-punched mounting holes.

Important: This molding is not part of the 4 piece grill surrounding moldings.

MB184616 1970..... 99.99 ea



1970 Barracuda Grill Inserts



Grill inserts for 1970 Barracuda models. These inserts are mounted on each side of the grill and feature correct chrome finish and mounting studs. Mounting hardware is not included.

ME1551 1970..... 344.99 pr

New!



ME17590

ME17597

ME17599

1970 Barracuda Grill Moldings

Reproduction grill moldings for 1970 Barracuda models. Manufactured to factory specifications featuring original style contours and stainless finish.

ME175946 1970 center - upper..... 54.99 ea

ME175947 1970 center - lower..... 54.99 ea

ME175949 1970 LH - on headlamp bezel..... 54.99 ea

ME175950 1970 RH - on headlamp bezel..... 54.99 ea

ME175951 1970 RH - on headlamp bezel..... 54.99 ea

ME175952 1970 RH - on headlamp bezel..... 54.99 ea

ME175953 1970 RH - on headlamp bezel..... 54.99 ea

ME175954 1970 RH - on headlamp bezel..... 54.99 ea

ME175955 1970 RH - on headlamp bezel..... 54.99 ea

ME175956 1970 RH - on headlamp bezel..... 54.99 ea

ME175957 1970 RH - on headlamp bezel..... 54.99 ea

ME175958 1970 RH - on headlamp bezel..... 54.99 ea

ME175959 1970 RH - on headlamp bezel..... 54.99 ea

ME175960 1970 RH - on headlamp bezel..... 54.99 ea

ME175961 1970 RH - on headlamp bezel..... 54.99 ea

ME175962 1970 RH - on headlamp bezel..... 54.99 ea

ME175963 1970 RH - on headlamp bezel..... 54.99 ea

ME175964 1970 RH - on headlamp bezel..... 54.99 ea

ME175965 1970 RH - on headlamp bezel..... 54.99 ea

ME175966 1970 RH - on headlamp bezel..... 54.99 ea

ME175967 1970 RH - on headlamp bezel..... 54.99 ea

ME175968 1970 RH - on headlamp bezel..... 54.99 ea

ME175969 1970 RH - on headlamp bezel..... 54.99 ea

ME175970 1970 RH - on headlamp bezel..... 54.99 ea

ME175971 1970 RH - on headlamp bezel..... 54.99 ea

ME175972 1970 RH - on headlamp bezel..... 54.99 ea

ME175973 1970 RH - on headlamp bezel..... 54.99 ea

ME175974 1970 RH - on headlamp bezel..... 54.99 ea

ME175975 1970 RH - on headlamp bezel..... 54.99 ea

ME175976 1970 RH - on headlamp bezel..... 54.99 ea

ME175977 1970 RH - on headlamp bezel..... 54.99 ea

ME175978 1970 RH - on headlamp bezel..... 54.99 ea

ME175979 1970 RH - on headlamp bezel..... 54.99 ea

ME175980 1970 RH - on headlamp bezel..... 54.99 ea

ME175981 1970 RH - on headlamp bezel..... 54.99 ea

ME175982 1970 RH - on headlamp bezel..... 54.99 ea

ME175983 1970 RH - on headlamp bezel..... 54.99 ea

ME175984 1970 RH - on headlamp bezel..... 54.99 ea

ME175985 1970 RH - on headlamp bezel..... 54.99 ea

ME175986 1970 RH - on headlamp bezel..... 54.99 ea

ME175987 1970 RH - on headlamp bezel..... 54.99 ea

Hood & Fender Moldings



1972-74 Challenger Grill Molding

Grill molding for 1972-74 Challenger models. This molding mounts to the headlamp panel and features correct finish and contours for an authentic appearance and fit. Made in USA.

MN1470 1972-74..... 154.99 ea



1967-69 Dart Hood Lip Molding Set

Replace your dented or missing hood lip molding with a complete molding set. Manufactured to original specifications with OEM-quality materials. Set includes the left, right, and the center connector. Replaces OE part numbers 2807757, 2807758 and 2807759.

K3278 1967-69..... 84.99 set

New!



MN1419



MN1422



1965-70 B-Body Hood Lip Moldings

Hood lip molding for various 1965-70 Plymouth and Dodge B-Body models. Manufactured to fit on original and reproduction style hoods. Features correct finish and mounts exactly as original.

Note: *Made in USA!

Plymouth B-Body Models

Hood Lip Molding
MN1420* 1966 Satellite/Belvedere 139.99 ea
MN1421* 1967 GTX/Satellite 134.99 ea
MB2651 1970 GTX/Road Runner 184.99 ea
Mounting hardware
MN2889 1967 GTX/Satellite 8.99 set

Dodge B-Body Models

Hood Lip Molding
MN1419* 1965 Coronet 134.99 ea
MN2171* 1966 Coronet 154.99 ea
MN1422* 1967 Coronet 154.99 ea
Mounting Hardware
MN2172* 1967 Coronet 19.99 set

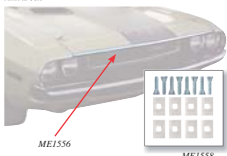

1970-74 Challenger Hood Lip Molding

Hood lip moldings for 1970-74 Challenger models. These moldings mount on the front edge of the hood and features correct finish and contours as original. Fender sections are not included.

Note: *Part number ME1556 will fit 1971 models but does not have the additional lip that extends under the front edge of the hood. **Hardware not for use with part # MN1426 molding with extended lip.

MN1424 1970 T/A..... 89.99 ea
ME1556* 1970-71 non T/A..... 89.99 ea
MN1426 1971 w/extended lip..... 144.99 ea
MN1427 1972-74 primered..... 144.99 ea
ME1558** 1970-71 mounting hardware 12.99 set



1964 Dodge B-Body Front Valance Molding

Replacement fender trim for 1964 Dodge 330,440 and Polara models. Features correct chrome plating and pre-punched mounting holes for easy installation. Sold as a pair.

MB1743 1964..... 444.99 pr



1964 330 and 440 Fender Side Moldings

Fender side moldings for 1964 330 and 440 models. These moldings mount on the side of the fender and complete the body side moldings. Feature correct chrome finish and mounting studs.

MB2263 1964..... 314.99 pr



1966-67 Charger Front Fender Moldings

Front fender "C" moldings for 1966-67 Charger models. Manufactured to original specifications, these moldings feature correct contours and correct chrome plating.

MB2335 1966-67..... 394.99 pr



1970-71 B & E-Body Fender End Moldings

Fender end moldings for 1970 Road Runner/GTX and 1971 Challenger SE models. These moldings mount on the front end of the fender to complete the hood lip molding, and feature correct finish and contours.

MB2178 1970 Road Runner/GTX..... 184.99 pr
ME1555 1971 Challenger SE..... 294.99 pr



1970 Dodge B-Body Front Valance Molding

Front valance molding for 1970 Dodge Coronet and Super Bee models. This piece mounts on the upper side of the front valance panel. Made in USA.

MN1464 1970..... 199.99 ea



1970 Challenger SE Front Valance Molding

Front valance molding for 1970 Challenger SE models. This molding mounts to the upper side of the front valance panel.

ME1653 1970..... 294.99 set



1972-74 Challenger Front Valance Molding

Front valance molding for 1972-74 Challenger models. Mounts to the upper side of the front valance panel. Made in USA.

MN1465 1972-74..... 179.99 ea

Wheel Opening Moldings



1964-69 Plymouth A-Body Wheel Opening Moldings

Replace the wheel opening moldings on your 1964-69 Barracuda or Valiant with these premium wheel opening molding sets. Manufactured to factory specifications with original-quality materials to give your Mopar a fresh look.

Note: Shipped oversize.

MP41207 1964-65 Barracuda.....	279.99 set
MP41207 1965 Valiant.....	279.99 set
MP41208 1966 all - w/pre-punched holes.....	309.99 set
MP41209 1966 all - w/o pre-punched holes.....	249.99 set
MN1477 1967-69 Barracuda - OER® - Made in USA.....	344.99 set



New!



1967-76 Dart Wheel Opening Moldings

Reproduction wheel opening moldings for 1967-76 Dart, Dart GT, Dart GTS and Dart Swinger models. Each molding is stamped to fit vehicle contours exactly and features the correct finish for an original fit and appearance. Sold individually or as a set of 4. Mounting screws included.

Note: Shipped oversize.
**Discounted sets. No further discounts apply.*

2785857 1967-76 LH front.....	72.99 ea
2785856 1967-76 RH front.....	72.99 ea
2932595 1967-76 LH rear.....	72.99 ea
2932594 1967-76 RH rear.....	72.99 ea
K3279* 1967-76 set of 4.....	248.99 set
MN1478 1967-76 set of 4 - Made in USA.....	344.99 set



1967-70 Valiant Front Wheel Opening Moldings

Reproduction front wheel opening moldings for 1967-70 Valiant 2 and 4 door models. Each molding is stamped to fit vehicle contours exactly and features the correct finish. Sold individually.

Note: Shipped oversize.

2807077 1967-70 LH front.....	72.99 ea
2807076 1967-70 RH front.....	72.99 ea



1971-76 Dodge A-Body Wheel Opening Moldings

Reproduction wheel opening moldings for 1971-72 Demon and 1973-76 Dart Sport models. Each molding is stamped to fit vehicle contours exactly in the correct finish for an authentic appearance. Sold individually or as a set of 4.

Note: Shipped oversize.
**Discounted sets. No further discounts apply.*

2785857 1971-76 LH front.....	72.99 ea
2785856 1971-76 RH front.....	72.99 ea
3444415 1971-76 LH rear.....	72.99 ea
3444414 1971-76 RH rear.....	72.99 ea
K3366* 1971-76 set of 4.....	233.99 set



1971-76 Valiant/Scamp Wheel Opening Moldings

Reproduction wheel opening moldings for 1971-73 Valiant/Scamp 2 door models only and 1974-76 Valiant/Scamp 2 and 4 door models. Each molding is stamped to fit vehicle contours exactly and features the correct finish for an original fit and appearance. Sold individually or as a set of 4. Mounting screws included.

Note: Shipped oversize.

**Discounted sets. No further discounts apply.*

2807077 1971-76 LH front.....	72.99 ea
2807076 1971-76 RH front.....	72.99 ea
2932595 1971-76 LH rear.....	72.99 ea
2932594 1971-76 RH rear.....	72.99 ea
K8568* 1971-76 set of 4.....	248.99 set



1970-76 Duster Wheel Opening Moldings

Reproduction wheel opening moldings for 1970-76 Duster models. Each set is stamped to fit vehicle contours exactly and features the correct finish, and pre-made mounting holes for an authentic appearance. Sold individually or as a set of 4.

Note: Shipped oversize.

**Discounted sets. No further discounts apply.*

2807077 1970-76 LH front.....	72.99 ea
2807076 1970-76 RH front.....	72.99 ea
3444415 1970-76 LH rear.....	72.99 ea
3444414 1970-76 RH rear.....	72.99 ea
K3787* 1970-76 set of 4.....	233.99 set



1968-70 Charger Wheel Opening Moldings

Reproduction wheel opening moldings for 1968-70 Charger models. Each set is stamped to fit vehicle contours exactly and features correct finish, and pre-made mounting holes. Sold individually or as a set of 4.

Note: Shipped oversize.

**Discounted sets. No further discounts apply.*

2932111 1968-70 LH front.....	64.99 ea
2932110 1968-70 RH front.....	64.99 ea
3004371 1968-70 LH rear.....	64.99 ea
3004370 1968-70 RH rear.....	64.99 ea
K2474* 1968-70 set of 4.....	233.99 set



New!



1960-76 Wheel Opening Molding Screw Set

Reproduction wheel opening molding screw set for all 1960-76 Mopar models. Manufactured to look and fit like the originals. Only one set per vehicle required.
MN2103 1960-76..... 7.99 set

Wheel Opening Moldings

OER AUTHORIZED **AUTHENTIC RESTORATION**

1968-70 Coronet Wheel Opening Moldings

Reproduction wheel opening moldings for 1968-70 Coronet models. Each set is stamped to fit vehicle contours exactly and features the correct finish for an original fit and appearance. Sold individually or as a set of 4.

Note: Shipped oversize.
*Discounted sets. No further discounts apply.



New!

2932285	1968-70	LH front		72.99	ea
2932284	1968-70	RH front		72.99	ea
2932113	1968-70	LH rear		72.99	ea
2932112	1968-70	RH rear		72.99	ea
K2768*	1968-70	set of 4		233.99	set
MN1475	1968-70	set of 4 - Made in USA		344.99	set

OER **AUTHENTIC RESTORATION**

1966-70 Plymouth B-Body Wheel Opening Moldings

Replace your dented or missing original wheel opening moldings with these premium molding sets. Manufactured to OE specifications and using original materials for an authentic appearance. For 1966-70 Plymouth B-Body models.

Note: Shipped oversize.



New!

MP41210	1966	Satellite		399.99	set
MP41210	1966-67	Belvedere		399.99	set
MP41210	1967	GTX		399.99	set
MN1480	1968-70	all (except 1969 GTX) OER®		344.99	set

OER **AUTHENTIC RESTORATION**

1969 GTX Wheel Opening Moldings

Replace your dented or missing original wheel opening moldings with this premium molding set. Manufactured to OE specifications and using original materials for an authentic appearance. Fits 1969 GTX models. Made in USA.

Note: Shipped oversize.



Made in USA

MN1482	1969		344.99	set
--------	------	--	--------	-----

OER **AUTHENTIC RESTORATION**

1971-72 Dodge B-Body Wheel Opening Moldings

Replace your dented or missing original wheel opening moldings with this premium molding set. Manufactured to OE specifications and using original materials for an authentic appearance. Fits 1971 Coronet and 1971-72 Charger models. Made in USA.

Note: Shipped oversize.



Made in USA

MN1483	1971-72		344.99	set
--------	---------	--	--------	-----

OER **AUTHENTIC RESTORATION**

1971-72 Plymouth B-Body Wheel Opening Moldings

Replace your dented or missing original wheel opening moldings with this premium molding set. Manufactured using OE specs and materials. Fits 1971 GTX, 1971-72 Satellite and 1971-72 Road Runner. Made in USA.

Note: Shipped oversize.



Made in USA

MN1484	1971-72		344.99	set
--------	---------	--	--------	-----

OER **AUTHENTIC RESTORATION**

1973-74 Charger Wheel Opening Moldings

Replace your dented or missing original wheel opening moldings with this premium molding set. Manufactured to OE specifications and using original materials for an authentic appearance. Made in USA.

Note: Shipped oversize.



Made in USA

MN1485	1973-74		344.99	set
--------	---------	--	--------	-----

OER **AUTHENTIC RESTORATION**

1970-74 Barracuda Wheel Opening Moldings

Replace your dented or missing original wheel opening moldings with this premium molding set. Manufactured using OE specs and materials for an authentic appearance. Fits all Barracuda and Cuda models from 1970 to 1974. Made in USA.

Note: Shipped oversize.



Made in USA

MN1488	1970-74		284.99	set
--------	---------	--	--------	-----

OER AUTHORIZED **AUTHENTIC RESTORATION**

1970-74 Challenger Wheel Opening Moldings

Reproduction wheel opening moldings for 1970-74 Challenger models. Each set is stamped to fit vehicle contours exactly and features the correct finish for an authentic appearance. Sold individually or as a set of 4.

Note: Shipped oversize.
*Discounted sets. No further discounts apply.



2965417	1970-74	LH front		72.99	ea
2965416	1970-74	RH front		72.99	ea
2965419	1970-74	LH rear		72.99	ea
2965418	1970-74	RH rear		72.99	ea
K2423*	1970-74	set of 4		233.99	set
MN1479	1970-74	set of 4 - Made in USA		344.99	set

Windshield & Sill Moldings

New!

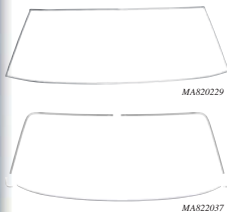

1968-76 A-Body Windshield Molding Set

Reproduction front windshield molding set for 1968-69 Barracuda, and 1968-76 Dart models. This official Mopar Authentic Restoration Product features correct finish and contours for an original appearance and fit.

Note: "Can also be used on 1967 Dart & Barracuda, but requires the use of 1968-76 style clips and screw-in studs.

MAK20229* 1968-69 'Cuda - coupe..... 269.99 set
 MAK20229* 1968-69 'Cuda - fastback... 269.99 set
 MAK20229* 1968-76 Dart..... 269.99 set
 MAK20229* 1972-76 Scamp..... 269.99 set
 MAK2037 1970-71 Demon..... 269.99 set
 MAK2037 1970-76 Duster..... 269.99 set
 MAK2037 1973-76 Dart Sport..... 269.99 set

New!



1967 A-Body Windshield Molding Clip

Windshield reveal molding clips for 1967 Barracuda, Valiant, and Dart models. This polished stainless steel clip installs in the corners of the front windshield molding. Four clips required per vehicle.

MP14019 1967 4 required..... 14.99 ea



1968-70 B-Body Windshield Molding Set

Reproduction windshield molding set for all 1968-70 B-Body models. This authentically reproduced set includes 5 moldings and 2 lower corner clips.

MB372 1968-70..... 259.99 set

New!



1970-74 E-Body Windshield Moldings

Reproduction windshield molding set for 1970-74 E-Body models. This official Mopar Authentic Restoration Product features the correct stainless finish and contours for an original appearance and fit.

ME175931 1970-74 5 piece set..... 269.99 set



1962-76 Windshield Molding Clip Sets

Clips are for attaching the moldings that surround the front windshield.

A-Body

1968-76 Dart - 2 Door Hardtop
 MA9867 1968-76 23 pieces..... 34.99 set
 1970-76 Dart Sport, Demon & Duster
 MA9868 1970-76 46 pieces..... 39.99 set

B-Body

MB2213 1962 23 pieces..... 34.99 set
 MB1164 1963 18 pieces..... 34.99 set
 MB1163 1966-67 48 pieces..... 39.99 set
 MB1161 1968-70 sedan, 24 pieces..... 34.99 set
 MB1162 1971-74 coupe, 20 pieces..... 34.99 set

E-Body

ME531 1970-74 hardtop, 12 pieces . 24.99 set



1968-76 Window Reveal Clip

Replacement windshield and rear window upper reveal molding clips for various 1968-76 models.

MD2108 1968-76 3/4" x 3/4"..... .99 ea
 MD2111 1974-76 15/16" x 5/8"..... 1.99 ea

New!



1964-66 Barracuda Rear Window Trim

Reproduction rear window trim for 1964-66 Barracuda fastback models. Trim pieces are die cast and chromed as original but are made with a two-part alloy that won't pit like the original pot metal pieces.

*Note: *1964-65. **1966*

MP41213* center trim panel "V" logo... 434.99 ea
 MP41214** center trim panel fish logo... 434.99 ea
 MP41215 LH trim panel..... 224.99 ea
 MP41216 RH trim panel..... 224.99 ea
 MP41217 LH trunk hinge trim..... 69.99 ea
 MP41218 RH trunk hinge trim..... 69.99 ea
 MP41219 center trim rubber pad..... 15.99 ea
 MP41220 trim gasket set (white foam) 17.99 set

New!



1968-70 B-Body Vent Window Frame

Reproduction of the vent window frame components for 1968-70 B-Body models. The cast and finished in bright chrome as original. Available as a complete set or just the vent window forward posts. The complete set includes the forward vent window posts, lower window frames, and upper hinge mounts.

MB280968 1968-70 complete set..... 589.99 set
 MB280967 1968-70 forward posts only 394.99 pr



Windshield Molding Clip Pliers

Great tool for removing most windshield molding clips. This tool is specifically designed to grab onto those annoying little molding clips and remove them safely without damaging the moldings.

Y35200..... 11.99 ea

Rocker & Side Moldings

1967-72 A-Body Rocker Moldings



Rocker moldings for 1967-72 A-Body models. These moldings mount underneath each door and run from the fender to the quarter panel. Features correct finish and contours.



*Note: Shipped double oversize. * Made in USA*

MN1431	1967-69	Dart GTS.....	274.99	pr
MA2092	1970-72	Duster/4 door Valiant.....	184.99	pr

1966-73 B-Body Rocker Moldings



Rocker moldings for 1966-73 B-Body models. These moldings mount underneath each door and run from the fender to the quarter panel. Features correct finish and contours.



*Note: Shipped double oversize. * Made in USA*

Dodge				
MN1438	1966-67	Charger/Coronet.....	299.99	pr
MN1445*	1968-70	Charger/Coronet/Super Bee.....	274.99	pr
MN1447*	1971-73	Charger/Super Bee/SE.....	274.99	pr

Plymouth

MN1436*	1967	GTX.....	274.99	pr
MN1440*	1968-70	all.....	229.99	pr

Mounting Hardware

MN1435	1966-67	Charger/Coronet.....	69.99	set
MN1441	1968-70	all.....	79.99	set
MN1437	1967	GTX.....	74.99	set
MN1929	1971-73	Charger/Super Bee/SE.....	49.99	set



1970-74 E-Body Rocker Moldings and Hardware



Rocker moldings and mounting hardware for 1970-74 E-Body models. These moldings mount underneath each door and run from the fender to the quarter panel. Features correct finish and contours.



*Note: Shipped double oversize. * Made in USA.*

Barracuda				
MN1452*	1971-72	rocker moldings.....	274.99	pr
MN1453*	1973-74	rocker moldings.....	274.99	pr
MN1454	1971-74	mounting hardware.....	49.99	set
Challenger				
MN1448*	1970-71	rocker moldings.....	274.99	pr
MN1449*	1972-74	rocker moldings.....	274.99	pr
MN1450	1970-71	mounting hardware.....	74.99	set
MN1454	1972-74	mounting hardware.....	49.99	set

1970 Cuda Rocker Moldings

New!



"Fish Gill" rocker moldings for 1970 Cuda models. These fiberglass/plastic composite moldings mount underneath each door and run from the fender to the quarter panel. Features correct flat argent silver finish.



Note: Shipped double oversize.

MN1930	1970	rocker moldings.....	149.99	pr
MN1928	1970	mounting screws.....	9.99	set

1969 Plymouth Lower Body Side Molding Set



Complete lower side molding set for 1969 GTX and Sport Satellite models. This complete set includes two fender moldings, one door molding and two quarter panel moldings for each side of the vehicle. Hardware sold separately.

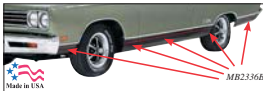

*Note: * Made in USA!*

MB2336B*	1969	10 piece set.....	489.99	set
MB2336A	1969	10 piece set.....	344.99	set
MN1498	1969	hardware.....	41.99	set

New!



MP41222 - sold individually



MP41223 - sold individually

1965 Dart GT Fender/Door Trim

Reproduction door and fender trim pieces for 1965 Dart GT models. Die cast and chromed as original. Sold individually, 3 required for each side.

MP41222	1965	LH.....	99.99	ea
MP41223	1965	RH.....	99.99	ea



MM1844

1969 Dodge B-Body Side Scoop Trim Bezels

Replacement side scoop trim bezels for 1969 Coronet, Super Bee and R/T models. Feature correct chrome plating and black accent paint for an original appearance.

MM1842	1969	LH upper or RH lower.....	34.99	ea
MM1843	1969	RH upper or LH lower.....	34.99	ea
MM1844	1969	set of four.....	99.99	set



ME1559



ME1560

1971 'Cuda Fender Gills

Fender gills for 1971 'Cuda models. Sold as a complete set, these gills feature correct chrome plating, black ribbed inserts. Mounting plates are sold in a set of 4, one set required per vehicle.

ME1559	1971	gill set.....	324.99	set
ME1560	1971	mounting plates.....	89.99	set
ME175953	1971	gaskets.....	8.99	set

New!



ME1652

1970-74 Barracuda Door Top Edge Moldings

Door top edge moldings for 1970-74 Barracuda models. Mounts to the outer top edge of the door and quarter panel. Designed to OE specs and produced with quality materials.

*Note: Hardware included is specific to 1970 models. * Made in USA.*

ME1652*	1970-74	w/hardware - coupe only.....	174.99	set
MN1472*	1970-74	w/o hardware, coupe only.....	199.99	set
MN2114*	1970-74	w/o hardware, convertible only.....	139.99	pr
Mounting Hardware				
MN1473	1970	mounting hardware.....	44.99	set
MN1474	1971-74	mounting hardware.....	34.99	set

Rear Window Moldings

New!



1967-76 A-Body Drip Rail Moldings

Reproduction drip rail molding sets for various 1967-76 A-Body models. Manufactured to factory specifications featuring original style contours and correct stainless steel finish.

MA688012	1967-69	Barracuda - fastback	199.99	set
MA688013	1967-69	Barracuda - coupe	199.99	set
MA688018	1967-76	Dart 2 door hardtop	199.99	set
MA688014	1970-76	Duster	199.99	set
MA688014	1971-72	Demon	199.99	set
MA688018	1972-76	Scamp	199.99	set
MA688014	1973-76	Dart Sport	199.99	set



1968-70 B-Body Drip Rail Molding Set

Drip rail molding set for all 1968-70 B-Body models. Features correct contours and stainless finish. Sold as a complete six piece set.

MB1679	1968-70		149.99	set
--------	---------	--	--------	-----

New!



1967-76 A-Body Back Glass Moldings

Reproduction windshield molding set for various 1967-76 models. This official Mopar Authentic Restoration Product features the correct stainless finish and contours for an original appearance and fit.

MM822034	1967-76	Dart	249.99	set
MM822035	1970-76	Duster	249.99	set
MM822034	1971-76	Scamp	249.99	set
MM822035	1971-72	Demon	249.99	set
MM822035	1973-76	Dart Sport	249.99	set



1968-70 Charger Back Glass Reveal Molding Set

Reproduction back glass reveal molding set for 1968-70 Charger models. Official Mopar Authentic Restoration Product. Features correct finish and contours.

MM1836	1968-70		217.99	set
--------	---------	--	--------	-----

AUTHENTIC RESTORATION

AUTHENTIC RESTORATION

MA688012

MA688013

MM822034

AUTHENTIC RESTORATION



1968-70 B-Body Back Glass Reveal Molding Set

Reproduction back glass reveal molding set for 1968-70 Mopar B-Body models. This official Mopar Authentic Restoration Product features correct finish and contours for an original appearance and fit.

MM1854	1968-70		239.99	set
--------	---------	--	--------	-----

AUTHENTIC RESTORATION



MM3079

1970-74 E-Body Back Glass Molding Set

Reproduction of the back glass molding set for 1970-74 E-Body models. Replace your pitted originals with quality replacements that feature the correct finish and contours.

MM3170	1970-74	Challenger	219.99	set
--------	---------	------------	--------	-----



MB1166

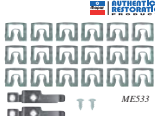

ME533

AUTHENTIC RESTORATION

1962-76 Rear Window Reveal Molding Clip Sets

Complete clip sets to attach back glass reveal moldings on various models.

A-Body

1968-76 Dart, Valiant				
MA9869	1968-76	2 door hardtop	34.99	set
1970-76 Dart Sport, Demon & Duster				
MA9870	1970-76	2 door hardtop	34.99	set
1968-69 Barracuda				
MA9871	1968-69	2 door coupe	29.99	set
MA9872	1968-69	2 door fastback	39.99	set

B-Body

MB1165	1962	except convertible	29.99	set
MB1168	1963	except convertible	9.99	set
MB1169	1964-65	2 door sedan	15.99	set
MB1170	1964-65	2 door hardtop	34.99	set
MB1171	1966-67	2 door hardtop	39.99	set
MB1166	1968-70	except convertible	39.99	set
MB1172	1968-70	Charger	39.99	set
MB1167	1971-74	except convertible	39.99	set

E-Body

ME532	1970	hardtop	34.99	set
ME533	1971-73	hardtop	34.99	set



MD2107



MD2110

AUTHENTIC RESTORATION

1971-76 Rear Window Reveal Molding Clips

Replacement rear window reveal molding clips. Each clip is manufactured to install in place of original clips without modification.

MD2107	1971-76	13/16" x 5/8"	1.99	ea
MD2110	1974-76	3/4" x 11/16"	1.99	ca

Rear Moldings



1968-70 B-Body Quarter Latch Assembly

Replace your pitted quarter latches with quality reproduction quarter window glass latch assemblies for 1968-70 B-Body models. Each latch features correct ribbed design and chrome finish as original.

MB1245 1968-70 B-Body Sedan 69.99 ea

New!



ME175942

1967-76 Vinyl Top Moldings

Reproduction vinyl top moldings for various 1967-76 models. Manufactured to factory specifications featuring original style contours and finish. These are the moldings that finish the rear lower part of the vinyl top.

Note: *Except Charger

A-Body

MA822051 1967-76 Dart - 6 pc set ... 199.99 set

MA822051 1972-76 Scamp - 6 pc set 199.99 set

B-Body

MB280987 * 1968-70 Dodge 174.99 pr

MB280988 1968-70 Plymouth 174.99 pr

E-Body

ME175941 1970-74 Barracuda 199.99 pr

ME175942 1970-74 Challenger 199.99 pr

New!



MB2254

1968-70 Charger Vinyl Top Moldings

Reproduction vinyl top moldings for 1968-70 Charger models. Feature reinforced mounting studs and correct chrome plating. These moldings mount on the inner and outer side of the sail panel, and run from the lower back window and quarter window to the end of the sail panel.

MB2254 1968-70 inners only 134.99 pr

MB281024 1968-70 inners/outers 299.99 set

New!



MN1864

1967-74 Vinyl Top Molding Clip Sets

Install your vinyl top moldings correctly with this complete clip set. Each set includes all fasteners required to mount the vinyl top moldings.

MN1859 1974 Duster 14.99 set

MN1863 1967-71 Dart 21.99 set

MN1864 1967-70 Charger 16.99 set

MN2102 1973-74 Charger SE 9.99 set



1966 Coronet 500 Quarter Moldings

Replacement quarter panel moldings for 1966 Coronet 500 models. These moldings mount horizontally on the quarter panel behind the doors. Features correct mounting studs and the black/chrome grooved pattern for an original appearance.

MB2253 1966 184.99 set

New!



1966 Coronet Tail Lamp Moldings

Enhance the appearance of your classic by replacing pitted, damaged or missing original outer tail lamp moldings with these high quality factory-style replacements. These are the C-shaped moldings that mount on the rear of the quarter panels and surround the tail lamps. Made in USA.

MN1456 1966 134.99 pr



1966-67 B-Body Sail Panel Moldings

Sail panel moldings for 1966-67 B-Body models except Charger. These moldings mount at the bottom of the sail panel and feature the correct chrome finish and mounting studs for an original appearance.

Note: Will not fit 1966-67 Charger.

MB2252 1966-67 154.99 pr



1966-67 Charger Quarter Panel Moldings

Quarter panel moldings for 1966-67 Charger models. These moldings are mounted vertically on the rear edge of the quarter panel. Features correct finish and mounts just like the originals.

MB2251 1966-67 184.99 pr



1968 Charger Outer Tail Panel Moldings

Outer tail panel moldings for 1968 Charger models. Mounts to the outer edge of the tail panel, this four piece set includes the two outer "C" shape moldings and the two lower connector pieces. Feature correct contours, mounting pins and finish.

MN1608 1968 4 piece set 99.99 set



1966-67 Charger Tail Lamp Moldings

Factory-style replacement tail lamp bezels for 1966-67 Charger models. Also referred to as "C" moldings, these bezels feature all proper contours and bright finish to correctly replace the original bezels. Sold as a pair for a complete replacement.

MB2155 1966-67 299.99 pr

New!



1969 Charger Tail Lamp Panel End Trim

Reproduction tail lamp panel end trim for 1969 Charger models. These are the moldings that mount to each end of the tail lamp panel, and connect to the center deck lid opening molding.

MB280973 1969 172.99 pr



1972-74 Barracuda Tail Lamp Trim Rings

These replacement tail lamp trim rings for 1972-74 Barracuda models feature the correct finish and mount just like the originals. Sold as a set of four.

ME5063 1972-74 Barracuda 64.99 set

Finish Panels & Rear Moldings

OEER AUTHORIZED 



MN1461



MN1607



MN2176



MN1463

1967-69 Plymouth B-Body Trunk Finish Panels

Rear trim panels for 1967-69 Plymouth B-Body models. Installs on the rear body panel between the tail lamps. These panels feature the correct paint scheme for an authentic appearance.

Important: *Coming soon. †Made in USA. **Note:** Shipped oversize.

Trunk Finish Panels

MN1461 †	1967	GTX	529.99	ea
MN1607 †	1968	GTX - emblem not included	839.99	ea
2841540* †	1968	Sport Satellite - emblem not included	839.99	ea
MN1462	1968	Road Runner	459.99	ea
MN2176	1968	Satellite	459.99	ea
MN1463* †	1969	GTX - emblem not included	839.99	ea
2902910* †	1969	Sport Satellite - emblem not included	839.99	ea

Trunk Finish Panel Mounting Hardware

MN2178	1968	Road Runner/Satellite	69.99	set
MN2892	1968	GTX/Sport Satellite	29.99	set

OEER AUTHORIZED



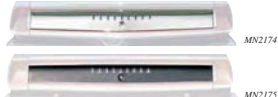

MN2174

MN2175

1969 Barracuda Trunk Finish Panels

Rear trim panels for 1969 Barracuda models. Installs on the rear body panel between the tail lamps. These panels feature the correct paint scheme and wording where applicable for an authentic appearance.

Important: *Formula S emblem not included.

Note: Shipped oversize.

Trunk Finish Panels

MN2174	1969	except Formula S	389.99	ea
MN2175*	1969	Formula S	389.99	ea

Trunk Finish Panel Mounting Hardware

MN2178	1969	all	69.99	set
--------	------	-----	-------	-------	-----

New!



1967 Plymouth B-Body Trunk Key Surround Bezel

Reproduction trunk panel key surround bezel for 1967 Plymouth B-Body models. Manufactured to factory specifications featuring correct chrome plating as original.

MN3065	1967	54.99	ea
--------	------	-------	-------	----

New!

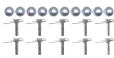

1969 Dart GT Trunk Trim Panel Hardware

Reproduction rear trunk mounting hardware for 1969 Dart GT models. Manufactured to factory specifications with enough hardware included to mount the center panel.

MN2886	1969	12.99	set
--------	------	-------	-------	-----

OEER AUTHORIZED 

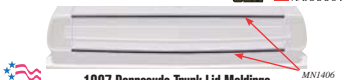

1967 Barracuda Trunk Lid Moldings

MN1406

Trunk lid moldings for 1967 Barracuda models. These moldings mount on the lower and upper rear portion of the trunk lid. Two required per vehicle. Mounting hardware available separately, one set required per molding. Made in USA

Note: Although the lower molding is not cosmetically correct it will fit and function properly.

MN1406	1967	molding	144.99	ea
MN2173	1967	hardware set	21.99	set



1963-64 Plymouth Fury Trunk Lid Molding

Reproduction rear trunk lid molding for all 1963-64 Plymouth Fury models. This molding features the correct stainless finish and will mount like the original. Made in USA.

MN2170	1963-64	349.99	ea
--------	---------	-------	--------	----



1966-67 Charger Tail Moldings

Reproduction tail panel moldings for 1966-67 Charger. Your choice of deck lid, upper or lower molding. "C" shaped tail lamp moldings sold separately. Buy the set and save! Our discounted set includes all three pieces, deck lid, upper and lower moldings.

Note: No further discounts apply.

3-Piece Molding Set

RM4132	1966-67	3-piece molding set	418.99	set
--------	---------	---------------------	-------	--------	-----

Individual Components

2809964	1966-67	deck lid molding	99.99	ea
2807394	1966-67	upper molding	159.99	ea
MB1840	1966-67	lower molding	204.99	ea

OEER AUTHORIZED 



1966 Coronet Trunk Lid Molding

Deck lid molding for 1966 Coronet models. This molding mounts on the rear edge of the trunk lid. Fits upper and lower. 2 required per vehicle. Made in USA.

MN1407	1966	134.99	ea
--------	------	-------	--------	----



1968-69 Charger Trunk Lid Molding

Replacement deck opening molding for 1968-69 Charger models. This molding mounts to the rear of the trunk lid opening and finishes off the tail panel molding set.

MB1678	1968-69	194.99	ea
--------	---------	-------	--------	----

Rear Moldings & Tools



1970 Coronet R/T Trunk Lid Molding

Trunk lid molding for 1970 Coronet R/T models. Features correct finish and contours. Made in USA.

MN1409 1970..... 199.99 ea



1970 GTX Rear Moldings

Rear moldings for 1970 GTX models. Feature the correct stainless finish and mounts the same way as the originals. The 3 piece set includes two quarter panel moldings and the upper trunk lid molding. Lower trunk molding and mounting hardware are available separately. Moldings made in the USA.

MN1410 1970 trunk and quarter pieces..... 230.99 set
 MN1411 1970 lower trunk lid..... 199.99 ea
 MN1412 1970 hardware for 3 piece set..... 39.99 set



ME5062

1970-71 Barracuda Rear Tail Moldings and Hardware

Tail moldings for 1970-71 Barracuda models. Sold as a complete four piece set, these moldings mount to the rear tail panel. Mounting hardware is not included with the set and is available separately.

ME5062 1970-71 4 piece set..... 199.99 set
 MN1430 1970-71 hardware set..... 39.99 set



ME1007

1970-74 Barracuda Rear Tail Moldings and Hardware

Rear tail molding set for 1970-71 Barracuda Gran Coupe and 1972-74 Barracuda models. This is a three piece set that mounts to the trunk lid and the quarter panels. Moldings made in USA.

ME1007 1970-74 3 piece set..... 199.99 set
 MN1415 1970-74 hardware set..... 39.99 set



K2426

1970-74 Challenger Rear Tail Moldings and Hardware

Tail moldings for 1970-74 Challenger models. These moldings are sold as a three piece set that include the trunk lid and the quarter panel moldings. Features correct finish and contours for an original fit and appearance.

K2425 1970 3 piece set..... 163.99 set
 K2426 1971-74 3 piece set..... 136.99 set
 MN1415 1970-74 hardware set..... 39.99 set



Universal Molding Release Tool

The ultimate tool for cleanly releasing moldings. Slide tool left or right under the molding until it hooks a retaining clip, then just rock the tool with a twist of the wrist to release the clip. Heat treated, high-carbon steel.

S21500 universal molding release tool..... 6.99 ea

Multi Wedge Prying & Scraping Tools

Multi Wedge is an amazing automotive restoration tool that will replace screwdrivers, pry bars and all other metal tools that can cause damage and marring to delicate surfaces! The soft, orange wedge set and the jumbo wedge are made from a high tech, specially blended polyethylene that is incredibly ductile so

they won't break or snap. The hard, black wedge set is made from a high tech, specially blended polycarbonate for the heavy duty jobs like oil pan covers, timing covers or valve covers. Save time and money by getting the job done quickly without having to repair nicks, dents, or scratches caused by using the wrong tool. Each 3 piece set includes one 4" curved end, one 4" straight blade and one 3" straight blade. Buy both sets and save! The jumbo wedge is 14" in length and 2" wide, making it perfect for the big jobs.

MW01 orange wedges, soft - set of 3..... 12.99 set
 MW02 black wedges, hard - set of 3..... 13.99 set
 MW03 both wedges, soft & hard - set of 6..... 19.99 set
 MW04 jumbo wedge..... 12.99 ea



Soft Prying and Scraping Tools

Available in 33 different fiberglass reinforced plastics, the soft duty tools are good for jobs where a minimum amount of force is needed to remove objects. The medium duty tools are better for the objects that require a little more force to remove and the heavy duty tools are for the objects that are real stubborn and just do not want to be separated from their current position. All these tools are strong enough to pry yet soft enough not to damage. With 7 tips to choose from: 3 pry bars, 2 wedge tools, a wedge puller and a sticker/gasket scraper, they can do various interior and exterior automotive jobs without the damage that metal tools can do. No chipping paint or tearing fabric. No toolbox should be without these great tools.

T23005 7 piece soft duty prying and wedging tools..... 24.99 set
 T2300M 7 piece medium duty prying and wedging tools..... 24.99 set
 T2300H 7 piece heavy duty prying and wedging tools..... 24.99 set
 T2301M 4 piece medium duty scraper tools..... 17.99 set
 T2301H 4 piece heavy duty scraper tools..... 17.99 set
 T2302 1 piece metric gap gauge 1-15mm..... 4.99 ea

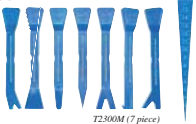

T2300M (7 piece)

T2302

Replacement Bulbs



Sealed Beam Headlamp Bulbs

These replacement sealed beam headlamp bulbs are perfect for maintaining the factory appearance and performance when the originals burn out.

Tungsten

4000	5-3/4" round	low beam.....	7.99 ea
T5001	5-3/4" round	high beam.....	9.99 ea
T0006	7" round	6 volt.....	9.99 ea
6014	7" round	12 volt.....	9.99 ea

Halogen

HS006	5-3/4" round	low beam.....	9.99 ea
H5001	5-3/4" round	high beam.....	9.99 ea
H6024	7" round	12 volt.....	9.99 ea

Halogen With Clear Lens

CH6024	7" round	12 volt.....	19.99 ea
--------	----------	--------------	----------



7" Crystal Headlamp Bulb w/ Auxiliary LED's

These crystal headlamps with auxiliary LED's give you classic ride a modern look. The aluminum reflector is a reinforced, multi-faceted design for maximum vibration resistance. A HB2900365/55W 12V halogen bulb replaces H6017/H6024 bulbs to meet DOT/SAE standards. Choose from 10 or 34-LED auxiliary lighting.

10 LED Bulb

CP500120	amber LED's.....	35.99 ea
----------	------------------	----------

34 LED Bulb

CP500121	amber LED's.....	64.99 ea
CP500122	white LED's.....	64.99 ea



7" High Power 11 LED Crystal Headlamp

This 7" crystal headlamp uses eleven high power LED to improve visibility, providing a white light similar to daylight. An impact resistant polycarbonate lens provides unparalleled protection from road hazards, while the solid state design resists shock and vibration. Meets SAE/DOT FMVSS108 standards.

CP500518	409.99 ea
----------	-------	-----------

5-3/4" Blue Dot

Crystal Headlamp Bulb

Add a classic blue dot look with these 5-3/4" crystal headlamps. Reinforced aluminum reflector, rugged anti-vibration construction. A 12V 65/55W SAE-9007 halogen bulb replaces H5001/H5006 bulbs. SAE approved.

CP500123	29.99 ea
----------	-------	----------



chrome housing



LED Halo

7" Projector Style Headlamps

Projector headlamps embody the classic look while substantially upgrading the quality and spread of light. The unique hi-low switch design provides a clean and safe light cutoff design, eliminating the issue of "headlight dazzling" on the roads. Each unit features a Bi-Xenon projector (high and low beams) with adjustable light focus and flat light distribution to prevent blinding of oncoming traffic. Available with a traditional chrome housing or with a black housing. Bulbs and wiring is included.

With 42mm Projector

Chrome Housing

152828	w/city light, w/o halo.....	269.99 pr
--------	-----------------------------	-----------

Black Housing

152829	w/city light, w/o halo.....	274.99 pr
--------	-----------------------------	-----------

With 64mm Projector

Chrome Housing

153135	w/o city light, w/o halo.....	359.99 pr
--------	-------------------------------	-----------

153137	w/o city light, with LED halo.....	399.99 pr
--------	------------------------------------	-----------

Black Housing

153134	w/o city light, w/o halo.....	359.99 pr
--------	-------------------------------	-----------

153136	w/o city light, with LED halo.....	399.99 pr
--------	------------------------------------	-----------



153108 - un-ill



153108 - illuminated



convex lens profile



flat lens profile

LED Powered Headlamps

Powerful LED CREE® technology combined with Delta Tech's Prismatic lens and flawless parabola delivers unmatched power, clarity and near daylight illumination at 1900 Lumens at both high and low beam, while drawing only 2 Amps per light. Each unit features an additional LED bulb that can be wired as a driving light, turn signal, park lamp or even as a mood light. Available in your choice of classic looking convex lens or modern style flat lens. Applications to fit two or four headlamp systems.

5-3/4" Classic Convex Lens

High Beam For 4 Headlamp System

153093	w/o blinker LED.....	319.99 pr
--------	----------------------	-----------

High/Low Beam For 4 Headlamp System

153094	w/o blinker LED.....	319.99 pr
--------	----------------------	-----------

7" Classic Convex Lens

High/Low Beam For 2 Headlamp System

153108	w/amber blinker.....	301.99 pr
--------	----------------------	-----------

153109	w/white blinker.....	301.99 pr
--------	----------------------	-----------

7" Modern Style Flat Lens

High/Low Beam For 2 Headlamp System

153110	w/amber blinker.....	301.99 pr
--------	----------------------	-----------

153111	w/white blinker.....	301.99 pr
--------	----------------------	-----------



152647 - with profile view



152648 profile view

Tri-Bar Custom Headlamps

Add a new look to your classic car with these custom headlamps. Manufactured with a metal housing and glass lens to meet high quality standards. Available in 7" and 5-3/4" sizes. The 7" lamp features an inner one-piece chrome glaze shield with black chrome plated center dot, and flat style lens. The 5-3/4" lamp has all of these features but uses convex glass and has a bullet style center ornament. Dust boot and clear halogen bulb included with each lamp.

152647	7" flat style.....	69.99 ea
--------	--------------------	----------

152648	5-3/4" convex w/bullet center.....	64.99 ea
--------	------------------------------------	----------



1149



1149 - profile 1179 - profile

Halogen/Xenon Headlamps

These conversion headlamps feature lead crystal lens with "E" mark certified precision optics, steel-stamped reflector and self-sealing rubber boot to protect the optic unit from dust and moisture. They are equipped with halogen H4 60/55W or xenon hyper white bulbs, which are 50% brighter than standard halogen bulbs, for superior performance. Your choice of classic looking convex lens or more modern looking flat lens. Applications to fit four headlamp or two headlamp systems.

5-3/4" Classic Convex Lens

High Beam For 4 Headlamp System

1129	Halogen.....	39.99 ea
------	--------------	----------

1129X	Xenon.....	54.99 ea
-------	------------	----------

High/Low Beam For 4 Headlamp System

1139	Halogen.....	41.99 ea
------	--------------	----------

1139X	Xenon.....	49.99 ea
-------	------------	----------

7" Classic Convex Lens

High/Low Beam For 2 Headlamp System

1179	Halogen.....	49.99 ea
------	--------------	----------

1179X	Xenon.....	79.99 ea
-------	------------	----------

7" Modern Style Flat Lens

High/Low Beam For 2 Headlamp System

1149	Halogen.....	59.99 ea
------	--------------	----------

1149X	Xenon.....	54.99 ea
-------	------------	----------

Diamond-Cut Headlamp Technology...

Replace your standard "yellow" headlamps with these unique halogen diamond cut headlamps for increased visibility, safety and a unique custom look. These headlamps install much like a standard sealed beam unit, but they allow the use of an H4 halogen bulb in your choice of color and wattage. Halogen bulbs are sold separately.

Note: For wire conversion, we recommend using our wiring harness upgrade kit sold separately.

MX09137	7" round.....	21.99 ea
---------	---------------	----------



Headlamp/Road Lamp Parts

New!



MIN1776

1963-76 Headlamp Adjustment Set

Replace your cracked or damaged headlamp adjusters. Available for 2 or 4 headlamp applications.

For 2 Headlamp Systems		
MN2898	1963-65	10.99 set
MN3052	1966-67	12.99 set
MN1775	1968-71	10.99 set
MN3054	1972-76	5.99 set

For 4 Headlamp Systems		
MN2899	1963-65	24.99 set
MN3053	1966-67	24.99 set
MN1776	1968-71	19.99 set
MN3055	1972-76	11.99 set



MX01132

H4 Conversion Wire Harness

This wiring harness upgrades the stock headlamp wiring on your vehicle, providing your new H4's with maximum power. Power is drawn directly from your battery, eliminating voltage drops and ensuring headlamp system reliability. Simply plug into your factory headlamp sockets, attach positive connectors to battery terminal and ground wires to the body of your vehicle. Two 30 amp relays provide added protection for your headlamp switch and wiring harness.

MX01132	for 2 headlamp system	29.99 set
MX01133	for 4 headlamp system	29.99 set



WE303

WE311

1965-76 Headlamp Socket and Wiring

A molded plastic socket used to connect the headlamp bulb. The socket has wire leads and connects the bulb to the power source. Fits all 1965-76 Mopar models.

WE303	1965-76	3 prong	2.99 ea
WE311	1965-76	2 prong	5.99 ea



1968-69 Charger Headlamp Conversion Set

These electric headlamp actuators are direct bolt in sets to replace defective vacuum systems on 1968-69 Charger models. This is a complete plug & play system with a control module that works with the existing headlamp switch. Manufactured in plastic.

MB1723	1968-69	529.99 set
--------	---------	------------



MB368



MB366

1968-69 Concealed Headlamp Components

Rebuild the functionality of the concealed headlamps on your 1968-69 Charger with our quality concealed headlamp components.

MB368	1968	actuator, hdmp dr...	314.99 ea
MB366	1968-69	vacuum canister	99.99 ea

PAINLESS



Auxiliary Light Relay Set

Install extra driving or fog lights easily and properly with our Auxiliary Light Relay Set. Switch can be wired to turn lights on per state law requirements: Low beams & auxiliary lights, Highbeams & auxiliary lights. Auxiliary light operation only. Includes lighted switch, wiring harness, 30 amp relay and terminals.

30803	disclosure apply	91.99 set
-------	------------------	-----------

LED Replacement Light Bulbs

Brighten up your tail and backup lamps with these direct replacement LED bulbs. LED lights shine up to 3 times brighter than conventional incandescent bulbs, plus they last longer, don't get hot and require fewer amps. LED lighting is also safer because they are brighter and they light up much quicker than conventional bulbs. LEDs flash on almost instantly, in approximately .05 seconds, giving the driver behind you valuable reaction time. These are available in the common dual contact 1157 tail/stop lamp bulb and the single contact 1156 backup lamp bulb.

Replacement For 1157		
500567	white	19.99 ea
500569	amber	19.99 ea
500571	white	20.99 ea
500572	blue	21.99 ea

Replacement For 1156		
500577	white	21.99 ea
500573	red	21.99 ea
500575	amber	21.99 ea

New!

AUTHENTIC MOTORCRAFT QUALITY

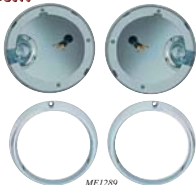

ME1289



ME1299

1970-71 'Cuda Road Lamps

Available as option code L34 in 1970-71, the road lamp option provided two round fog lamps below the front bumper on each side of the front license plate bracket. Each set includes LH and RH housings, chrome bezels, socket, pigtail, lamp decals, GE sealed beams marked with the correct "FOG" lettering and include mounting hardware. Mounting brackets are sold separately.

Lamp Kit	ME1307	1970-71	w/blubs	269.99 kit
----------	--------	---------	---------	------------

Components				
MMS36040	1970-71	replacement bulb	10.99 ea	
ME1289	1970-71	housing/bezels	274.99 set	
ME1298	1970	mounting bracket	54.99 pr	
ME1299	1971	mounting bracket	54.99 pr	



ME1290



ME1295



ME1292



ME1293



ME1296

1970-71 'Cuda Road Lamp Parts

Replace damaged or missing road lamp components with our replacement parts and bring this rare option back to life on your car. Our wire harness kits include all of the under dash wiring as well as the forward light harness. The retaining clip set secures the wiring to the core support at the front of the car.

ME1290	1970-71	bezel set	84.99 set
ME1295	1970-71	retaining clip 4pc	44.99 set
ME1291	1970	switch & bezel	184.99 ea
ME1293	1970	wire harness	104.99 ea
ME1296	1971	relay	184.99 ea
ME1292	1971	switch & bezel	184.99 ea
ME1294	1971	wire harness	104.99 ea

Replacement Bulbs

All The Bulbs You Need For Your 1960-76 Mopar



1960-76 Replacement Bulbs

Replacement bulbs for a variety of applications. Choose the correct bulb by matching the number on the base of your original bulb. Descriptions listed below only provide a reference for application. Individual applications may vary depending on vehicle model and year.

P/N	Bulb Type	Base	Watts/CP	Price
53	G-3 1/2	mini bayonet	1 CP.....	1.99 ea
57	G-4 1/2	mini bayonet	2 CP.....	1.99 ea
74	T-1 3/4	miniature wedge	.70 CP.....	1.99 ea
89	G-6	single contact bayonet	6 CP.....	1.99 ea
90	G-6	double contact bayonet	6 CP.....	2.99 ea
158	T-3 1/4	wedge	2 CP.....	1.99 ea
161	T-3 1/4	wedge	1 CP.....	1.99 ea
168	T-3 1/4	wedge	3 CP.....	1.99 ea
194	T-3 1/4	wedge	2 CP.....	1.99 ea
257	G-4 1/2	mini bayonet	1.6 CP.....	2.49 ea
330	T-3 1/4	midjet flange	.5 CP.....	1.99 ea
562	T-3	flat clip	6 CP.....	2.99 ea
1003	B-6	single contact bayonet	15 CP.....	1.99 ea
1004	B-6	double contact bayonet	15 CP.....	2.99 ea
1034	S-8	double contact indexed	3/32 CP.....	2.99 ea
1034A	S-8	double contact indexed (amber)	23 CP.....	2.99 ea
1073B	S-8	single contact bayonet	32 CP.....	2.99 ea
1141	S-8	single contact bayonet	21 CP.....	1.99 ea
1156	S-8	single contact bayonet	32 CP.....	1.99 ea
1157	S-8	double contact indexed	3/32 CP.....	1.99 ea
1157A	S-8	double contact indexed (amber)	3/32 CP.....	1.99 ea
1445	G-3 1/2	mini bayonet	.7 CP.....	1.99 ea
1816	T-3 1/4	mini bayonet	3 CP.....	1.99 ea
1891	T-3 1/4	mini bayonet	2 CP.....	1.99 ea
1892	T-3 1/4	mini bayonet	.75 CP.....	1.99 ea
1893	T-3 1/4	mini bayonet	2 CP.....	1.99 ea
1895	G-4 1/2	mini bayonet	2 CP.....	1.99 ea
B1815	T-3 1/4	mini bayonet	1.4 CP.....	1.99 ea
B363	G-3 1/2	mini bayonet	2 CP.....	1.99 ea
B67	G-6	single contact bayonet	4 CP.....	1.99 ea
MB2122	T-3	mini cap	6 CP.....	2.50 ea

Tail/Stop Lamp



Back-Up Lamp



Instrument Lamp



License Plate Lamp



Colored Lamp Bulbs

Have some fun, switch over to blue, green, red or purple bulbs for show use.
Note: Using a bulb other than amber is not street legal, therefore, use colored bulbs for off road or show use only.

Tail/Stop Lamp 1157

XX201	clear	2.99 pr
MX01200	purple	4.99 pr
MX01201	amber	4.99 pr
MX01203	green	4.99 pr
MX01204	red	7.99 ea

Back-Up Lamp 1156

XX202	clear	2.99 pr
MX01209	purple	4.99 pr
MX01205	amber	4.99 pr
MX01207	green	4.99 pr
MX01208	red	4.99 pr

Instrument Lamp 194

XX203	clear	3.99 pr
MX01214	purple	4.99 pr
MX01211	blue	3.99 pr
MX01213	red	4.99 pr

License Plate Lamp 67

XX204	clear	2.99 pr
MX01224	purple	4.99 pr
MX01220	amber	4.99 pr
MX01221	blue	4.99 pr
MX01222	green	4.99 pr
MX01223	red	4.99 pr



MX01106 MX01109 MX01111

Ultra White Blue Bulbs

Upgrade your lighting to Ultra White Blue Bulbs and enjoy a light that simulates daylight and reduces glare, fatigue and eye strain. Your vehicle will stand out in a crowd with the modern blue/white look of these bulbs. Available in a variety of bulb types and wattages to fit your specific needs. If you choose a bulb that is of a higher wattage than stock, we recommend installing our upgrade harness sold separately. Sold as a pair. 12 volt.

MX01106	H4, 100/90W	15.99 pr
MX01109	9005, 100W	15.99 pr
MX01110	9005, 65W	15.99 pr
MX01111	9006, 80W	15.99 pr
MX01113	9006, 55W	15.99 pr



542212X

Halogen/Xenon H4 Bulbs

These xenon gas filled bulbs are 50% brighter than halogen and offer a hyper white beam. They are a direct replacement for 5-3/4" or 7" headlights.

Replacement Bulbs

Halogen H4		
542212	60/55w	14.99 pr
Xenon H4		
542212X	60/55w	24.99 pr
545812X	100/80w	24.99 pr
546912	130/90w	24.99 pr

H4 Adapter Plug Set w/Wires

This plug is designed to adapt the factory 2 prong high beam headlamp plug to fit the upgraded halogen or xenon 3 prong bulbs.

200016	adapter	4.99 ea
--------	---------	---------

Relay And Fuse Assembly

Protect your H4 investment with this 5 prong 30 amp relay and 20 amp fuse set with 14 gauge wire leads.

200011	relay/fuse	7.99 ea
--------	------------	---------

Reference Our Comprehensive Light Bulb Guide

Refer to the Information section (Section O) for a complete and detailed list of light bulbs for applications covered in this catalog!



- A-Body Models
- B-Body Models
- E-Body Models

Located in the Back of the Catalog

Turn Signal Indicators



1967-72 Fender Mounted Turn Signal Assemblies

Replace the broken, inoperative or missing fender mounted turn signal indicator lamp assemblies on your 1967-72 model to enhance the overall appearance of your vehicle. They come complete with LH and RH lamp assemblies and mounting hardware.

Dodge A-Body			
MD324	1968-69	Dart	289.99 set
MD326	1970-72	Dart, Demon	149.99 set
Plymouth A-Body			
MD324	1967	Valiant Signet	289.99 set
MD324	1968	Valiant	289.99 set
MD326	1969	Valiant	149.99 set
MD326	1970	Valiant, Duster	149.99 set
MD328	1971	Valiant, Duster, Scamp	184.99 set
MD326	1972	Valiant, Duster, Scamp	149.99 set
Dodge B-Body			
MB1873	1967	Charger	257.99 set
MD326	1969-71	Coronet	149.99 set
MD326	1971	Charger	149.99 set
Plymouth B-Body			
MD324	1967	all models	289.99 set
MD324	1968	Belvedere, GTX, Sport Satellite	289.99 set
MD326	1969	Belvedere, Satellite	149.99 set
MD324	1969	GTX, Road Runner	289.99 set
MD328	1971	GTX, Satellite, Road Runner	184.99 set
E-Body			
MD327	1970	Barracuda, Cuda	184.99 set
MD328	1971	Barracuda, Cuda	184.99 set
MD326	1970	Challenger w/340 engine package	149.99 set
MD327	1970-71	Challenger except w/340 engine package	184.99 set

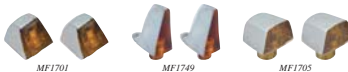

1966-72 Fender Mounted Indicator Lenses

Replace your faded or missing fender mounted turn signal indicator lenses with these quality reproduction pieces. Fits various A, B, and E-Body vehicles.

A-Body			
MF1701	1966	Plymouth	54.99 pr
MF1749	1966	Barracuda	54.99 set
MF1701	1968	Barracuda	54.99 pr
MF1705	1968-72	all	54.99 pr
B-Body			
MF1701	1966	Plymouth	54.99 pr
MF1701	1967	Coronet	54.99 pr
MF1704	1967	Charger	64.99 pr
MF1702	1966	Satellite	54.99 pr
MF1703	1967-69	Roadrunner/GTX	59.99 set
MF1705	1968-72	all except Roadrunner/GTX	54.99 pr
MF1706	1971	Roadrunner/GTX	54.99 pr
E-Body			
MF1705	1970-72	all	54.99 pr
MF1707	1970	Cuda	54.99 pr
MF1706	1971	Cuda	54.99 pr

1967-69 Bullet Indicator Mounting Brackets

Replace damaged or missing bullet indicator brackets with these quality reproduction pieces. These brackets are designed to match the contours of the fender of various A, B, and C-Body vehicles, as original.



MF1716 1967-69 29.99 pr



1966-72 Fender/Hood Mounted Indicator Gaskets

Replace dried out or missing hood or fender mounted turn signal indicator gaskets with these quality reproduction pieces. Fits various A, B, C, and E-Body vehicles.

A-Body			
MF1709	1966-72	fender mounted	8.99 pr
MF1710	1967-69	hood mounted bullet indicator	8.99 pr
MF1711	1966-68	Coronet belt indicator	8.99 pr
B-Body			
MF1709	1966-72	fender mounted	8.99 pr
MF1710	1967-69	hood mounted bullet indicator	8.99 pr
MF1711	1966-68	Barracuda bevel indicator	8.99 pr
MF1712	1970	Roadrunner/GTX hood mounted	8.99 pr
MF1713	1971	Roadrunner/GTX under fender	8.99 pr
MF1714	1971	Roadrunner/GTX fender mounted	8.99 pr
C-Body			
MF1709	1966-72	fender mounted	8.99 pr
E-Body			
MF1713	1971	Cuda under fender	8.99 pr
MF1714	1971	Cuda fender mounted	8.99 pr
MF1715	1970	Cuda fender mounted	8.99 pr



1968-70 Charger/Daytona Hood Mounted Turn Signal Indicator Parts

Replace the damaged hood mounted turn signal indicator lamp assemblies on your 1968-70 Charger or Daytona with quality parts to enhance the overall appearance of your Mopar.

Complete Assemblies			
MB309	1968-69	Charger	204.99 pr
MB310	1969	Charger Daytona	204.99 pr
MB310	1970	Charger	204.99 pr
Housing Components			
MB357	1968-69	housing	44.99 ea
MB358	1968-69	retainer for housing	24.99 ea
Lenses			
MB359	1968-69	amber lenses	54.99 pr
MB360	1970	sold individually	49.99 ea
Wiring Components			
MB362	1968-70	clip, wire retainer	3.99 ea
MB365	1968-70	primary wire, lead to main harness	39.99 ea
MB363	1970	ground strap, bulb insert to screw	9.99 ea
MB364	1970	lead wire, indicator to primary wire	39.99 ea



1970 Plymouth B-Body Hood Mounted Turn Signals

These 1970 GTX or Road Runner lamp assemblies mount in the rear of the hood bulge facing the driver and will fit, function and appear as original. Will fit models equipped with the optional L31 hood mounted turn signal indicator lamps.

Complete Assemblies			
MB313	1970		204.99 pr
Lenses Only			
MF1708	1970		69.99 set

1968 Barracuda Hood Mounted Turn Signals

Replace the pitted, inoperative or missing hood mounted turn signal indicator lamp assemblies on your classic with these factory-style replacements to enhance the overall appearance of your vehicle. This set includes both LH and RH assemblies and mounting hardware.

MD325 1968 204.99 set

Park Lamp Components

New!



1964 Plymouth B-Body Park Lamp Lenses

Reproduction parking lamp lenses for 1964 Plymouth B-Body models. Manufactured to factory specifications with a special UV protector to prevent fading and cracking. Mounting gaskets are included.

MB280966 1964..... 69.99 pr



MA2066



MA2067



MA2065

1967-69 Barracuda Park Lamp Lenses

Front park lamp lenses for 1967-69 Barracuda models. These lenses install on the grill and feature correct markings as well as the chrome ornament on the center of the lens. Lenses include lens to housing gaskets.

MA2066 1967..... 84.99 pr

MA2067 1968..... 84.99 pr

MA2065 1969..... 84.99 pr



MA2069



MA2070

MA2071

1968-71 Dart Park Lamp Lenses

Front park lamp lenses for all 1968-71 Dart models. These lenses install on the grill. Lenses include lens to housing gaskets.

MA2069 1968..... 58.99 pr

MA2070 1969..... 64.99 pr

MA2071 1970-71..... 84.99 pr



1970-72 Duster Park Lamp Lenses

Park lamp lenses to replace the damaged or missing lenses on your 1970-72 Duster. Lenses include lens to housing gaskets.

MA2072 1970-72..... 64.99 pr



1971-72 Duster Park Lamp Lenses

Replacement park lamp lenses for 1971-72 Duster models equipped with a sharktooth grill. Features correct silver trim and will fit and mount like the originals.

MA1181 1971-72 Duster 340..... 184.99 set



1963 Plymouth Park Lamp Lens

Reproduction park lamp lens for 1963 Plymouth B-Body models. Features the correct center pattern with the chrome edge. Gasket not included.

MB2801 1963..... 64.99 ea



1964 Dodge Polara Park Lamp Lenses

Factory style reproduction park lamp lenses for 1964 Dodge Polara, 330, and 440 models. These lenses install in the front bumper and feature the correct color and markings. Includes gaskets. Sold as a pair.

MB5980 1964 Polara, 330, 440..... 99.99 pr



MB2119



MB2120

1967-69 Plymouth B-Body Park Lamp Lenses

Parking lamp lenses for 1967-69 B-Body models. Features the correct circular diffuser pattern.

MB2119 1967 clear..... 64.99 pr

MB2120 1968-69 amber..... 58.99 pr



1966 Belvedere Park Lamp Lens



Factory-style replacement lens for 1966 Belvedere models. Mounting gasket is included.

MB2800 1966..... 54.99 ea

New!



MB2152



MD2062



MB2123

1968-74 Charger Park Lamp Lenses

Reproduction park lamp lenses for 1968-74 Charger models. Lens to housings gaskets sold separately.

MB2152 1968-69 clear..... 69.99 pr

MD2062 1970 amber..... 76.99 pr

ME175943 1970 clear..... 134.99 pr

MB2123 1971-74 clear..... 99.99 pr



MB2124



MB2125



MB2126

1970-72 Plymouth B-Body Park Lamp Lenses

Park lamp lenses for 1970-72 B-Body models. Available with correct amber or clear colored lenses. Lens to housing gaskets sold separately.

Note: After February of 1971, some models were originally equipped with amber lenses.

MB2124 1970 clear..... 99.99 pr

MB2125 1971 clear..... 114.99 pr

MB2126 1971-72 amber..... 114.99 pr

Park Lamp Components



1970 Superbird Park Lamp Lenses

Replacement park lamp lenses for 1970 Superbird. Features correct color, pattern and includes lens to housing gaskets.

MB2122 1970..... 296.99 pr

New!



MD2062

1970-74 Challenger Park Lamp Lenses

Replacement amber or clear park lamp lenses for 1970-74 Challenger models. Lens to housings gaskets sold separately.

MD2062 1970-74 amber..... 76.99 pr

ME175943 1970-74 clear..... 134.99 pr



ME1523



ME1524



ME1525

1970-74 Barracuda Park Lamp Lenses

Park lamp lenses for 1970-74 Barracuda models. Features correct markings on the lens.

ME1523 1970..... 339.99 set

ME1524 1971..... 239.99 pr

ME1525 1972-74..... 99.99 pr

AUTOMATIC RESTORATION



1968 Dodge Dart Park Lamp Assemblies

Reproduction park lamp assemblies for all 1968 Dodge Dart models. Manufactured with great attention to detail, these complete assemblies include the correct color lenses, housings and wiring pigtail. Sold as a pair.

MA8172 1968..... 149.99 pr



1968-69 Coronet Park Lamps

Reproduction park lamps for 1968-69 Dodge Coronet models. These lamps mount into the front bumper and include the correct color lenses, housings and wiring pigtail. Sold as a pair.

Park Lamp Assemblies

MB5984 1968-69 Coronet..... 139.99 pr

Park Lamp Lenses

MB2121 1968-69 includes gaskets..... 69.99 pr

AUTOMATIC RESTORATION



1970 B-Body Park Lamp Assemblies

Reproduction park lamp assemblies for 1970 B-body models including Belvedere, GTX, Road Runner, Satellite and Superbird. Each assembly is manufactured to factory specifications and includes the housing, wire pigtail and correct color lenses with markings as original. Sold as a pair.

MB5986 1970..... 119.99 pr

AUTOMATIC RESTORATION



ME8144

ME8145

1970-74 Challenger Park Lamp Assemblies

Factory style reproduction park lamp assemblies for 1970-74 Dodge Challenger and 1970 Dodge Charger models. Each assembly is manufactured to factory specifications with the correct housing, wire pigtail and proper lens color.

ME8144 1970-74 LH..... 119.99 ea

ME8145 1970-74 RH..... 119.99 ea

AUTOMATIC RESTORATION



1970-71 Park Lamp Housings

Factory style reproduction park lamp housings for 1970-71 Barracuda models. Each housing features the correct reflective finish and includes wiring pigtail.

ME1858 1970 Barracuda..... 314.99 pr

ME1859 1971 Barracuda..... 314.99 pr



ME1308

1967-74 A, E-Body Park Lamp Bezels

Park lamp bezels for 1967-74 A & E-Body models. These replacement bezels feature the correct chrome finish for an original appearance.

Barracuda

MA2073 1967..... 179.99 pr

MA2074 1968..... 179.99 pr

MA2075 1969..... 179.99 pr

ME1308 1972-74..... 149.99 pr

Duster

MA2076 1970-72..... 134.99 pr

New!



Made in USA

MB1751

1963-76 Park Lamp Lens Gaskets

Replacement park lamp lens gaskets for various 1963-76 models. These gaskets are manufactured to fit and function like the factory gaskets. Sold as a pair. Made in the USA.

A-Body	
MA822069 1964-65	Barracuda..... 8.99 pr
MA1160 1966	Barracuda..... 8.99 pr
MA1161 1967	Barracuda..... 8.99 pr
MA2493 1968	Barracuda..... 8.99 pr
MA1162 1969	Barracuda..... 8.99 pr
MA822068 1966	Valiant..... 8.99 pr
MA1163 1967-68	Valiant..... 8.99 pr
MA1164 1970-72	Duster/Valiant..... 8.99 pr
MA1165 1973-76	Duster/Valiant..... 8.99 pr
3478549 1972	Duster w/shark tk..... 8.99 pr
MA822070 1963-64	Dart..... 8.99 pr
MA822071 1965	Dart..... 8.99 pr
MA822072 1966	Dart..... 8.99 pr
MA1167 1967	Dart..... 8.99 pr
MA1168 1968	Dart..... 8.99 pr
MA1169 1969	Dart..... 8.99 pr
MA1170 1970-71	Dart..... 8.99 pr
MA1171 1972	Dart..... 8.99 pr
MA1172 1973-74	Dart..... 8.99 pr
MA1170 1971	Demon..... 8.99 pr
MA1171 1972	Demon..... 8.99 pr

B-Body	
MB1994 1965	Coronet..... 8.99 pr
MB1744 1966	Coronet..... 8.99 pr
MB1745 1967	Coronet..... 8.99 pr
MB1746 1968-69	Coronet..... 8.99 pr
MB1747 1970	Belvedere..... 8.99 pr
MB280994 1963	Belvedere..... 12.99 pr
MB280995 1964	Belvedere..... 8.99 pr
MB1745 1965	Belvedere..... 8.99 pr
MB1748 1966	Belvedere..... 8.99 pr
MB1745 1967	Belvedere..... 8.99 pr
MB1749 1966-67	Charger..... 8.99 pr
MB1750 1968-69	Charger..... 8.99 pr
MD4238 1970	Charger..... 8.99 pr
MB1751 1971-74	Charger exc. R/T..... 8.99 pr
MB1752 1968-69	Road Runner..... 8.99 pr
MB1753 1970	Road Runner..... 8.99 pr
MB1754 1971-72	RR/Satellite..... 8.99 pr

E-Body	
ME5064 1970	Barracuda..... 8.99 pr
ME5065 1971	Barracuda..... 8.99 pr
ME5066 1972-74	Barracuda..... 8.99 pr
MD4238 1970-74	Challenger..... 8.99 pr

Side Marker Lamps

LED AUTHORIZED

AUTHENTIC RESTORATION PARTS



1968 A & B-Body Side Marker Lamps
Side marker lamp assemblies for various 1968 A-Body and B-Body models. Features correct red or amber lens and includes the bezel, lens, bulb housing, socket, lens gasket and correct retaining hex nut. Available in your choice of curved style or flat style.
Note: Coronet and Super Bee models used flat lights on the front and curved lights on the rear.

Flat Style - Made in USA

MD2052	1968	front	55.99 ea
MD2053	1968	rear	55.99 ea

Curved Style - Made in USA

MD2054B	1968	front	54.99 ea
MD2055B	1968	rear	54.99 ea

Curved Style

MD2054A	1968	front	39.99 ea
MD2055A	1968	rear	39.99 ea

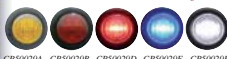

3 LED Mini Clearance/Marker Lamp

These 3 LED mini-clearance/marker lamp add a custom touch to your classic ride. Requires a 1/316" hole for installation.
Note: Fabrication may be required for installation.

CP50029A	amber LED's w/amber lens	8.99 ea
CP50029B	red LED's w/red lens	8.99 ea
CP50029C	amber LED's w/clear lens	8.99 ea
CP50029D	red LED's w/clear lens	8.99 ea
CP50029E	blue LED's w/clear lens	8.99 ea
CP50029F	white LED's w/clear lens	8.99 ea

LED AUTHORIZED



1969 A & B-Body Side Marker Lenses

Side marker lamp lenses. For all 1969 A-Body and B-Body vehicles except station wagon models. Sold as a pair.

MD2056	1969	front	34.99 pr
MD2057	1969	rear	34.99 pr

AUTHENTIC RESTORATION PARTS

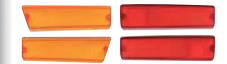

1970 Dodge Side Marker Lenses

Side marker lamp lenses for 1970 Charger and Coronet models. Lens to housing gaskets are included.

MB2103	1970	front	84.99 pr
MB2104	1970	rear	84.99 pr

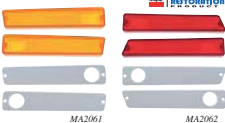

1970-71 Dart Side Marker Lenses

Side marker lenses for 1970-71 Dart models. Includes the lens to housing gaskets.

MA2061	1970-71	front	84.99 pr
MA2062	1970-71	rear	84.99 pr

LED AUTHORIZED



1970-71 Plymouth Side Marker Assemblies

Factory style reproduction front and rear side marker assemblies for 1970-71 Plymouth models including 1970-71 Duster, 1970 GTX and 1970 Road Runner. Each assembly is manufactured to factory specifications with the correct housing, wire pigtail and proper lens color.

MB1790	1970-71	front	LH	74.99 ea
MB1791	1970-71	front	RH	74.99 ea
MB1793	1970-71	rear	LH	74.99 ea
MB1792	1970-71	rear	RH	74.99 ea

LED AUTHORIZED



1970-71 Plymouth Side Marker Lenses

Replace damaged lenses with correct side marker lenses for 1970 Plymouth B-Body models and 1970-71 Duster models. Sold as a pair.

MD2058	1970-71	front	59.99 pr
MD2059	1970-71	rear	59.99 pr

AUTHENTIC RESTORATION PARTS



1971 Plymouth Side Marker Lenses

Side marker lens and housing assemblies for 1971 Road Runner and GTX models. These lenses include gaskets.

MB2108	1971	front	159.99 pr
MB2109	1971	rear	159.99 pr

LED AUTHORIZED

AUTHENTIC RESTORATION PARTS



1971 Charger/Super Bee Side Marker Lenses

Factory style reproduction front and rear side marker lenses for 1971 Dodge Charger and Super Bee models. Your choice of replacement lens set or lens with bezel.

Lens Set

MB2105	1971	front	amber	124.99 pr
MB2106	1971	rear	red	124.99 pr

Lens with Bezel - OER Authorized

MB1794	1971	front	amber	49.99 ea
MB1795	1971	rear	red	49.99 ea

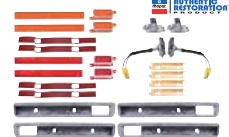

1970-71 Barracuda Side Marker Set

Reproduction side marker and bezel set for 1970-71 Barracuda models. Features correct finish and markings for an authentic appearance. This set includes everything necessary to replace your side marker assemblies. Included are four bezels, eight lenses, eight gaskets, two front bulb housings with pigtails, two rear bulb housings and four retainers.

Complete Side Marker Set

ME1522	1970-71	side marker set	344.99 set
--------	---------	-----------------	-------	------------

Side Marker Lenses Only

ME1511	1970-71	front	49.99 set
ME1512	1970-71	rear	49.99 set

AUTHENTIC RESTORATION PARTS



1970-71 Challenger Side Marker Set

Reproduction side marker and bezel set for 1970-71 Challenger models. This set includes everything necessary to replace your side marker assemblies. Included are four bezels, four lenses and four lens-to-housing gaskets. This set features correct finish and markings as original.

Complete Side Marker Set

ME1518	1970-71	side marker set	314.99 set
--------	---------	-----------------	-------	------------

Side Marker Lenses Only

ME1513	1970-71	front	39.99 set
ME1514	1970-71	rear	39.99 set

BODY COMPONENTS

Side Marker Components



MN1708



MN1707

1972-76 Side Marker Lamp Assemblies

Mopar factory OEM side marker lamp assemblies for 1972-76 A-Body, 1972-74 B-Body and E-Body models. Front amber and rear red lenses are available.

A-Body

MN1708	1972-76	front amber	24.99 ea
MN1707	1972-76	rear red	24.99 ea

B-Body, E-Body

MN1708	1972-74	front amber	24.99 ea
MN1707	1972-74	rear red	24.99 ea



1969 A & B-Body Side Marker Bezels

Replace the missing or damaged original side marker lamp bezels on your 1969 A-Body and B-Body vehicles. For all models except station wagon.

MD2060	1969	front/rear	79.99 pr
--------	------	------------	----------



1970-71 Dart/Demon Side Marker Bezels

Side marker bezels for 1970-71 Dart and 1971 Demon models. Features correct markings and includes the housing to body gaskets. Front bezels include pigtail.

MA2063	1970-71	front	144.99 pr
MA2064	1970-71	rear	134.99 pr



MB2110



MB2111

1970 Charger Side Marker Bezels

Side marker lamp bezels for 1970 Charger models. Features correct chrome finish on the back. The front bezels also include pigtail.

MB2110	1970	front	144.99 pr
MB2111	1970	rear	134.99 pr



MB2112

1970 Coronet Side Marker Bezels

Side marker lamp bezels for 1970 Coronet models. These quality replacements feature the correct chrome finish and front bezels include pigtail.

MB2112	1970	front	144.99 pr
MB2113	1970	rear	134.99 pr



MB2117



MB2116

1970 Plymouth B-Body Side Marker Bezels

Side marker bezels for 1970 Road Runner, GTX and Satellite models. The front bezels also include pigtails. Must paint to match.

MB2116	1970	front	94.99 pr
MB2117	1970	rear	74.99 pr



1971 Plymouth B-Body Side Marker Bezels

Side marker bezels for 1971 Road Runner, GTX and Satellite models. These bezels will replace originals in appearance, but must be painted to match.

MB2118	1971	front/rear	49.99 pr
--------	------	------------	----------



MB2114

1971 Charger Side Marker Bezels

Side marker bezels for 1971 Charger models. Feature correct markings and include the bezel to body gaskets. Must be painted to match.

MB2114	1971	front	64.99 pr
MB2115	1971	rear	64.99 pr



ME861012

1968-76 Side Marker Lamp Gaskets

Replacement side marker lamp gaskets for various 1968-76 A, B and E-Body models. These gaskets are laser cut to original specifications for a proper fit. Each set includes enough pieces for both sides of vehicle.

A-Body

MD600320	1968	all models	9.99 set
MD600321	1969	all models	11.99 set
MA820162	1970-71	Dart	16.99 set
MA820163	1971	Scamp	16.99 set
MA820164	1971	Demon	13.99 set
MD600323	1970-71	Charger	11.99 set
MD600322	1972-76	all models	7.99 set

B-Body

MD600320	1968	all models	9.99 set
MD600321	1969	all models	11.99 set
MB184556	1970	Charger	9.99 set
MB184557	1971	Charger	13.99 set
MB184558	1970	Superbird	16.99 set
MD600323	1970	Road Runner	11.99 set
MB184560	1971	RR/Satellite	10.99 set
MB184556	1970-71	Coronet	9.99 set
MD600322	1972-74	all models	7.99 set

E-Body

ME861012	1970-71	Barracuda	16.99 set
ME861013	1970-71	Challenger	16.99 set
MD600322	1972-74	all models	7.99 set

1970-71 Barracuda Side Marker Bezels

Side marker housings for 1970-71 Barracuda models. Each housing set features correct markings and includes two bezels and two housings. Front sets also include wiring pigtail.

ME1519	1970-71	front	144.99 set
ME1520	1970-71	rear	124.99 set
ME1521	1970-71	retainer	19.99 ea



ME1521



ME1519



ME1520

Tail Lamp Components

LED AUTHORIZED



1967 Dodge Dart Tail Lamp Assemblies

Reproduction tail lamp assemblies for 1967 Dodge Dart models. Each assembly is manufactured to factory specifications with the correct housing, chrome bezel and proper lens color. Includes assembly to body gaskets. Sold as a pair.

MA8170 1967..... 324.99 pr

LED AUTHORIZED



1968 Dodge Dart Tail Lamp Assemblies

Reproduction tail lamp assemblies for 1968 Dodge Dart models. Each assembly is manufactured as original with the correct housing, chrome bezel and proper lens color. Sold as a pair.

MA8171 1968..... 449.99 pr

AUTHENTIC RESTORATION



1968 Charger Tail Lamp Sets

1968 Charger tail lamp assemblies designed for an authentic appearance and fit, each complete set includes LH and RH housings as well as all lenses and bezels.

MB281 1968..... 1091.99 set



unlit view

lit view

1968 Charger LED Tail Lamp

Give your 1968 Charger some modern style with these sleek LED tail lamps. These are direct replacements for the original bulbs and install with no wiring or splicing; just plug into the factory bulb socket and enjoy bright, crisp modern lighting. Each lens features the correct center accent and 25 LEDs*. Sold individually, four required per vehicle.

MB1756 1968..... 34.99 ea

DIGITAL



1967-74 LED Tail Lamps

These LED replacement tail lamp fits perfectly behind your factory lens and bezel, respond faster than conventional bulbs, and are brighter than DOT requirements.* Using high intensity, wide-angle LEDs, these lamps splice into the rear wire harness to increase visibility and add a modern touch to your Mopar. The circuit boards are designed to use the maximum housing area with LEDs arranged to compliment original lens facets for optimal light output. Includes all installation hardware. One set does both sides.

Note: Lens, housings and bezels not included.

A-Body

MA8175 1967	Barracuda	189.99 set
MA8175 1969	Barracuda	189.99 set
MA8176 1969	Dart	189.99 set
MA8177 1971-74	Dart	189.99 set

B-Body

MB1987 1968	Charger	249.99 set
MB1988 1969-70	Charger	299.99 set
MB1989 1968	Road Runner	189.99 set
MB1990 1969	Road Runner	189.99 set
MB1991 1970	Road Runner	189.99 set

E-Body

ME8153 1970	Barracuda	189.99 set
ME8154 1971	Barracuda	189.99 set
ME8155 1972-74	Barracuda	189.99 set
ME8156 1970	Challenger	249.99 set
ME8157 1971	Challenger	239.99 set
ME8158 1972-74	Challenger	189.99 set

AUTHENTIC RESTORATION



MA2077

MA2079

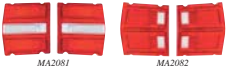

MA2081

MA2082



MA2083



MA2466

1967-71 A-Body Tail Lamp Lenses

Replacement tail lamp lenses for 1967-71 A-Body models. Each lens features all correct markings and trim for an authentic appearance.

MA2077 1967	Barracuda	244.99 pr
MA2078 1968	Barracuda	294.99 pr
MA2079 1969	Barracuda	179.99 pr
MA2080 1967	Dart	154.99 pr
MA2081 1968	Dart	124.99 pr
MA2082 1969	Dart	79.99 pr
MA2083 1970	Dart	99.99 pr
MA2466 1970-71	Duster	294.99 pr

AUTHENTIC RESTORATION



MB2127

MB2143

1963-74 B-Body Tail Lamp Lenses

Replacement tail lamp lenses for 1963-74 B-Body models. Each lens features all correct markings and trim for an authentic appearance.

MB2127 1963	330/440	239.99 pr
MB2128 1964	Polara	74.99 pr
MB2129 1964	Fury	294.99 pr
MB2130 1964	Belvedere, Savoy	294.99 pr
MB2131 1965	Belvedere	294.99 pr
MB2132 1965	Coronet models	184.99 pr
MB2142 1966	Charger	494.99 set
MB1858 1966	Satellite w/chrm trim	184.99 pr
MB1892 1966	Belvedere w/o trim	154.99 pr
MB2142 1967	Charger	494.99 set
MB2133 1967	Coronet R/T, 500	164.99 pr
MB2134 1967	GTX, Satellite	179.99 pr
MB2143 1968	Charger	179.99 set
MB2135 1968	GTX, Road Runner	158.99 pr
MB1856 1969	Charger/Daytona	394.99 pr
MB2136 1969	GTX, Sport Satellite	169.99 pr
MB2137 1969	Road Runner, Satellite	159.99 pr
MB1857 1970	Charger	394.99 pr
MB2138 1970	GTX, Road Runner	239.99 pr
MB2141 1971	Charger R/T, SE	394.99 pr
MB2139 1971	GTX, w/o blk trim	69.99 pr
MB2139 1971	Rd Runner, w/o blk trim	69.99 pr
MB5982 1971	GTX, w/ blk trim	324.99 pr
MB5982 1971	Rd Runner, w/ blk trim	324.99 pr
MB2140 1972	GTX, Road Runner	394.99 pr
MB2141 1973	Road Runner	184.99 pr
MB2145 1973-74	Charger, w/silver	249.99 pr
MB2141 1974	Road Runner	184.99 pr
MB5983 1973-74	Charger, w/o silver	299.99 pr

AUTHENTIC RESTORATION



ME1528

ME1597

1970-74 E-Body Tail Lamp Lenses

Replacement tail lamp lenses for 1970-74 E-Body models. Each lens features all correct markings and trim for an authentic appearance.

ME1528 1970	Barracuda	184.99 pr
ME1530 1970	Challenger	264.99 set
ME1529 1971	Barracuda	184.99 pr
ME1597 1972-74	Barracuda	184.99 pr

PAINLESS



Brake Light Relay Set

When upgrading tail lights to the new higher wattage halogens, always use a relay. The Painless set gives you everything you need to protect your wiring and switches.

Note: No further discounts apply.

30105 31.99 set

UNIVERSAL

Tail Lamp Components

New!



LED Lamp Flashers

Due to the lower current draw of LED lamps, these electronic 12 volt flashers are recommended for use on vehicles equipped with LED lamps. Available in 20 amp or a 25 amp. The 20 amp is available in two or three prong type.

Important: If installing LEDs on both the front and rear, two flashers are usually required.

B6207	20 amps	2 prong	11.99 ea
B6208	20 amps	3 prong	11.99 ea
F90652	25 amps	2 prong	11.99 ea

AUTHORIZED

AUTHENTIC RESTORATION



MA2088

MA2089



MA2091

MB2153



MB2166



ME1533

1963-76 Tail Lamp Bezels

Tail lamp bezels for various 1963-76 models. Each bezel features the correct finish and will replace your originals exactly.

A-Body			
MA2088	1968	Dart	164.99 pr
MA2089	1969	Dart	204.99 pr
MA2090	1973-74	Dart Sport	394.99 set
MA2091	1973-76	Duster	394.99 pr

B-Body			
MB2153	1963	Dodge 330/440	394.99 pr
MB2154	1963	Belvedere	494.99 pr
MB2155	1966-67	Charger	299.99 pr
MB2156	1968	Charger	239.99 set
MB2158	1967	Coronet R/T, 500	394.99 pr
MB2159	1968	Coronet R/T	524.99 pr
MB2160	1970	Coronet, Super Bee	344.99 pr
MB2161	1967	GTx, Satellite, red.	159.99 pr
MB1986	1967	GTx, Satellite, silver	159.99 pr
MB2162	1968	GTx	294.99 pr
MB2163	1969	GTx, Sport Satellite	629.99 pr
MB2164	1970	GTx	394.99 pr
MB2165	1971	GTx/Road Runner	199.99 pr
MB2166	1968	Road Runner	294.99 pr
MB2167	1969	Road Runner	394.99 pr
MB2168	1970	Road Runner	344.99 pr

E-Body			
ME1531	1970	Cuda-painted bezel	184.99 pr
ME1532	1970	Cuda-chrome trim	204.99 pr
ME1534	1971	Cuda-painted bezel	184.99 pr
ME1533	1971	Cuda-chrome trim	204.99 pr
ME1535	1970	Challenger	494.00 set



MA2084

MA2086



MB2148

MB2149



MB2146

MB2151

1964-69 Tail Lamp Housings

Tail lamp housings for various 1964-69 models. Replace your pitted or damaged originals with quality replacements. Features correct fit, finish & configuration.

A-Body			
MA2084	1967	Barracuda	394.99 pr
MA2085	1968	Barracuda	394.99 pr
MA2086	1969	Barracuda	394.99 pr
MA2087	1967	Dart	374.99 pr
MA2477	1968	Dart, LH	79.99 ea
MA2478	1968	Dart, RH	79.99 ea
2930725	1969	Coronet	494.99 pr
2930724	1969	Dart, LH	119.99 ea
		Dart, RH	119.99 ea
B-Body			
MB2146	1964	all Plymouth	444.99 pr
MB2147	1965	Belvedere	494.99 pr
MB2148	1966	Belvedere/Satellite	394.99 pr
MB2149	1965	Coronet	494.99 pr
MB2150	1965	Coronet 500	504.99 pr
MB2151	1968	Charger	629.99 pr

AUTHENTIC RESTORATION



1965 Coronet Tail Lamp Bezel Extension

Reproduction tail lamp bezel extension for 1965 Coronet 500 models. These pieces are mounted above the tail lamp lenses, and feature the correct textured area surrounding the Fratzog with the chrome border. MB192019 1965 Coronet 500..... 184.99 pr

AUTHENTIC RESTORATION



MA1159

MA4736

1967-69 Barracuda Tail Lamp Lens Trim

Replacement tail lamp lens trim for 1967 or 1969 Barracuda models. The trim for 1967 models features the correct chrome border with textured center. Sold as a pair. MA1159 1967..... 79.99 pr
MA4736 1969..... 79.99 pr

New!



MB280979

1964-74 Tail Lamp Housing Hardware

Reproduction tail lamp housing to body mounting hardware for various 1964-76 models. Manufactured to mount the tail lamp housings to body, using factory style hardware that looks and fits like the originals. Only one set required per vehicle.

A-Body			
MA822045	1967-69	Dart	22.99 set
MA822046	1971-72	Demon	12.99 set
MA822050	1964-65	Barracuda	37.99 set
MA822050	1965	Valiant	37.99 set

B-Body			
MB280975	1968	Charger	19.99 set
MB280976	1968	Coronet	13.99 set
MB280977	1968	GTx	16.99 set
MB280977	1968	Road Runner	16.99 set
MB280978	1969	Coronet	29.99 set
MB280979	1969	GTx	29.99 set
MB280979	1969	Road Runner	29.99 set
MB280980	1969-70	Charger	39.99 set
MB280981	1970	Coronet	16.99 set
MB280982	1970	GTx	17.99 set
MB280982	1970	Road Runner	17.99 set

E-Body			
ME175932	1970	Challenger	59.99 set
ME175933	1970	Barracuda	14.99 set
ME175934	1971	Challenger	42.99 set
ME175935	1971	Barracuda	14.99 set
ME175936	1972-74	Challenger	59.99 set
ME175937	1972-74	Barracuda	39.99 set

New!



1969-70 Tail Lamp Stud Protector Set

Reproduction tail lamp stud protector caps for 1969 Road Runner, GTx and 1970 Barracuda. These red caps were installed on the end of the tail lamp housing studs to prevent injuries when working in the tail lamp area. MN2104 1969 Road Runner/GTx..... 6.99 set
MN2104 1970 Barracuda..... 6.99 set

New!



The "TattleTale" Pulsing Brake Light

Designed to get attention, an inertia switch (which is adjustable by you, using supplied installation bracket) detects panic stop situations and rewrites the brake signal through an electronic pulsator. Under normal braking situations the brake lights react normally, but when hard braking occurs, the lights pulse rapidly, alerting other drivers of a panic stop. This system is great for 3rd brake lights and is for use with systems up to 60 watts (5 amps). Simple and easy to install. Includes installation instructions. T7095..... 94.99 ea

Tail Lamp Gaskets/Back-Up Lamps

1963-76 Tail Lamp Gasket Sets

New!

Replacement tail lamp gaskets for various 1963-76 models. These gaskets are laser cut to original specifications making them the most correct on the market. Each set contains the necessary gaskets to repair both tail lamps on one vehicle.



MB184589

A-Body

Dodge	Year	Model	Price
MA822075	1963	Dart	11.99 set
MA822076	1964	Dart	19.99 set
MA822077	1965	Dart	29.99 set
MA822078	1966	Dart	29.99 set
MA820171	1967	Dart	28.99 set
MA820172	1968-69	Dart	28.99 set
MA820173	1970	Dart	17.99 set
MA820174	1971-73	Dart	17.99 set
MA820175	1973-76	Dart Sport	20.99 set
MA820176	1974-76	Dart	23.99 set
MA820177	1971-72	Demon	34.99 set

Plymouth

MA822073	1964-65	Barracuda	24.99 set
MA822074	1965	Barracuda	26.99 set
MA820178	1967	Barracuda	32.99 set
MA820179	1968	Barracuda	32.99 set
MA820180	1969	Barracuda	32.99 set
MA820181	1964	Valiant	28.99 set
MA820182	1966	Valiant	28.99 set
MA820183	1967	Valiant	28.99 set
MA820184	1968	Valiant	32.99 set
MA820185	1969	Valiant	17.99 set
MA820189	1970-73	Valiant	17.99 set
MA820176	1974-76	Valiant	23.99 set
MA820186	1970-71	Duster	24.99 set
MA820187	1972	Duster	23.99 set
MA820188	1973-76	Duster	23.99 set

B-Body

Dodge	Year	Model	Price
MB184568	1965	Coronet exc. 500	28.99 set
MB184569	1965	Coronet 500	28.99 set
MB184570	1966	Coronet	28.99 set
MB184571	1967	Coronet exc. R/T	28.99 set
MB184572	1967	Coronet R/T	28.99 set
MB184573	1968	Coronet	28.99 set
MB184574	1969	Coronet/Super Bee	28.99 set
MB184575	1969	Coronet R/T	28.99 set
MB184576	1970	Coronet/Super Bee	28.99 set
MB184577	1970	Coronet R/T	28.99 set
MB184578	1966-67	Charger	39.99 set
MB184579	1968	Charger	17.99 set
MB184580	1969-70	Charger	32.99 set
MB184581	1971	Charger exc. R/T	17.99 set
MB184582	1971	Charger R/T	20.99 set
MB184583	1972	Charger Rallye	20.99 set
MB184583	1972	Charger exc. Rallye	17.99 set
MB184584	1973-74	Charger	17.99 set

Plymouth

MB280996	1963	Belvedere	24.99 set
MB280997	1964	Belvedere	29.99 set
MB280998	1965	Belvedere	29.99 set
MB184585	1966	Belvedere	28.99 set
MB184586	1967	Belvedere	28.99 set
MB184587	1968	Road Runner	28.99 set
MB184588	1969	Road Runner	28.99 set
MB184589	1969	GTX/Satellite	28.99 set
MB184590	1970	Road Runner/GTX	28.99 set
MB184591	1970	Satellite	23.99 set
MB184592	1971	RR/Satellite	17.99 set
MB184593	1972	RR/Satellite	17.99 set
MB184594	1973-74	RR/Satellite	17.99 set

E-Body

ME861015	1970-71	Barracuda	28.99 set
ME861016	1972-74	Barracuda	28.99 set
ME861017	1976	Challenger	34.99 set
ME861018	1971	Challenger	32.99 set
ME861019	1972-74	Challenger	28.99 set



MB1771



MB1915



MB2210



1963-65 Plymouth B-Body Back-Up Assemblies

Replacement back-up lamp assemblies for 1963-65 Plymouth Belvedere and 1965 Satellite models. Features the correct lens pattern and chrome housing and includes the lens to housing gasket. Will not fit station wagon models. The housing to body seals are available separately.

MB1771	assemblies	199.99 pr
MB1915	lenses only - Made in USA	69.99 pr
MB2210	seals only - Made in USA	5.99 pr



MB1859



MB1860



MB1861

1966-67 B-Body Back-Up Lamp Components

Replacement back-up lamp components for 1966-67 Charger and 1967 Coronet models. The housings feature chrome plating and include the wiring pigtail.

Note:	Assemblies and the lenses include mounting gaskets.	
MB1859	assemblies	214.99 pr
MB1860	housings	154.99 pr
MB1861	lenses	54.99 pr

New!

1963-65 B-Body Back-Up Lamp Covers

Reproduction back-up lamp socket covers for 1963-65 B-Body models. These covers help keep dirt and water out of the back-up lamp. Replace those original covers with brand new reproductions. Sold in pairs.

MP44100	1963-65	19.99 pr
---------	---------	----------



MB316



MB317



MB318

1969-70 B-Body Back-Up Lamp Assemblies

Back-up lamp assemblies for 1969-70 Charger and 1969 Road Runner models. The complete assembly includes everything you need for a bolt-on solution includes bezels, lenses, retainers, socket and pigtail. Parts are also available for repairing original lamps.

Complete Assembly Set

MB316	1969-70 bezel/lamp set	154.99 set
Components		
MB317	1969-70 lenses	44.99 pr
MB318	1969-70 wire lens retainers	15.99 pr

DEF AUTHORIZED

1970 B-Body Back-Up Lamp Assemblies

Factory style reproduction back-up lamp assemblies for 1970 B-body models including Belvedere, GTX, Road Runner, Satellite and Superbird. Each assembly is manufactured to factory specifications with the correct housing, wire pigtail and proper lens color. Sold as a pair.

MB5985	1970	169.99 pr
--------	------	-----------

DEF AUTHORIZED

1964 Dodge Polara Back-Up Lamp Lenses

Factory style reproduction back-up lamp lenses for 1964 Dodge Polara models. These clear lenses feature the correct markings. Includes gaskets. Sold as a pair.

MB5981	1964	74.99 pr
--------	------	----------

Back-Up/License Plate Components



MB264



MB286



MB299



MB274

1965-70 Back-Up Lamp Lenses

Replacement back-up lamp lenses for various 1965-70 models. Manufactured to look and fit like the originals with mounting gaskets included. For various B-Body vehicles including Belvedere, Coronet, GTX, Road Runner and Satellite. Also available for 1970 Challenger models.

Dodge	Year	Model	Price
MB192018	1965	Coronet 440	84.99 pr
MB264	1966	Coronet	54.99 pr
MB1861	1966-67	Charger	54.99 pr
MB1861	1966-67	Charger	54.99 pr
MB286	1968	Charger	54.99 pr
ME12229	1970	Challenger	74.99 ea
Plymouth	Year	Model	Price
MB299	1967	all models	54.99 pr
MB274	1970	all models	144.99 pr



1972-74 Barracuda Back-Up Lamp Lenses

Regain the appearance and functionality of the back-up lamp lenses on your 1972-74 Barracuda with these quality lenses.

ME1598	1972-74		204.99 pr
--------	---------	--	-----------



1966 Coronet Back-Up Lamp Housings

Back-up lamp housings for 1966 Coronet models. These housings feature an integrated bezel design for an original fit, function and appearance.

MB265	1966		154.99 set
-------	------	--	------------



MA1512



MA1513

1969 Barracuda Back-Up Lamp Bezels

Back-up lamp bezels for 1969 Barracuda models feature correct mounting locations and chrome finish. The short style bezel design will also fit and function on 1967 models, but is only cosmetically correct for 1969 models.

MA1512	1969	short style	144.99 pr
MA1513	1969	long style	154.99 pr

New!



MB2209

1963-73 Back-Up Lens Gaskets

Replacement back-up lamp lens gaskets for various 1963-73 Dodge and Plymouth models. Made in USA.

A-Body			
MA4734	1967	Barracuda	13.99 set
MA4734	1969	Barracuda	13.99 set
MA4734	1962-64	Valiant	13.99 set
MA822080	1963-64	Dart	12.99 set
MA822081	1966-67	Dart	8.99 set
MA4735	1970-73	Valiant	9.99 set
B-Body			
MB2207	1963-65	Belvedere/Satellite	4.99 set
MB1772	1966	Belvedere	9.99 set
MB1773	1967	Belvedere	9.99 set
MB1774	1966	Coronet	9.99 set
MB1775	1967	Coronet	9.99 set
MB1775	1966-67	Charger	9.99 set
MB2208	1968	Charger	4.99 set
MB1776	1969-70	Charger	11.99 set
MB1776	1969	Road Runner	11.99 set
MB2209	1970	Plymouth B-Body	8.99 set



MD2590



ME5044

1968-74 Front License Plate Bracket

Replacement license plate brackets for 1968-69 Charger and 1970-74 E-Body models. Manufactured from 18 gauge steel for extra strength and powder coated black for long life. License plate mounting hardware is included.

MD2590	1968-69	Charger	21.99 ea
MD2590	1970-72	Barracuda	21.99 ea
ME5044	1973-74	Barracuda	19.99 ea
ME5043	1970-71	Challenger	24.99 ea
ME5044	1972-74	Challenger	19.99 ea



1970-74 License Plate Spring Assembly

Replacement license plate spring assembly for 1970-74 Barracuda models. This assembly is mounted behind the rear license plate to allow the license plate to fold when fueling.

ME5045	1970-74	Barracuda	54.99 ea
--------	---------	-----------	----------

New!



1961-65 License Lamp Lens

Reproduction license lamp lens for all 1961-65 Dodge and Plymouth models. Manufactured to factory specifications each lens features the correct markings and are coated with a special UV protector to prevent fading and cracking due to exposure from the elements. Mounting gasket is included.

MD4713	1961		34.99 ea
MD4714	1962-65		34.99 ea



1966-74 Bullet Style License Plate Lens

This lens is for vehicles equipped with the "bullet style" license plate lamp and includes lens, screws and gasket. For wide variety of A-Body vehicles including 1966-67 Barracuda, 1966-72 Valiant, 1971-72 Demon, Duster and B-Body vehicles including 1966-67 Coronet, Charger, 1970-74 Belvedere, GTX, Road Runner, Satellite, 1970-74 Charger and 1970-71 Coronet.

MD334	1966-74	bullet style	14.99 ea
-------	---------	--------------	----------



1968-74 Oval Style License Plate Lens

This lens is for vehicles equipped with the "oval style" license plate lamp and includes lens, screws and gasket. For a wide variety of A-Body vehicles including 1968-69 Barracuda, 1967-72 Dart, B-Body vehicles including 1966-67 Belvedere, GTX, Satellite, 1968-69 Charger, Coronet, Super Bee and E-Body models including 1970-74 Challenger.

MD335	1966-74	oval style	14.99 ea
-------	---------	------------	----------



1970-74 Barracuda License Plate Lens

Regain the appearance and functionality of the license plate lamp on your 1970-74 Barracuda with this replacement lens that includes lens, screws and gasket.

ME1315	1970-74	long style	14.99 ea
--------	---------	------------	----------

1966-74 License Plate Screw & Nut

New!



Reproduction license plate screw and nut for all 1966-74 models. Use as required, includes two screws, and two retaining nuts.

MN2881	1966-74	all models	3.99 set
--------	---------	------------	----------

1963-74 License Lamp Lens Gasket

New!



License lamp lens gaskets for various 1963-74 models. Made in USA.

MB280999	1963-65	Belvedere	6.99 ea
MA822084	1964	Barracuda	4.99 ea
MA822084	1964	Valiant	4.99 ea
MA822079	1965	Barracuda	4.99 ea
MA822079	1965	Dart	4.99 ea
MB281002	1965	Coronet	4.99 ea
MB2212	1966	Barracuda	4.99 ea
MB2212	1966	Dart & Valiant	4.99 ea
MD1651	1967-69	Barracuda	4.99 ea
MD1651	1967-72	Dart	4.99 ea
MB2212	1970-72	Demon and Duster	4.99 ea
MB2212	1966-67	Charger	4.99 ea
MD1651	1968-70	Charger	4.99 ea
MB2212	1971-74	Charger	4.99 ea
MB2212	1968-74	Road Runner	4.99 ea
MD2212	1968-74	Satellite	4.99 ea
MD1651	1970-74	Challenger	4.99 ea
MD1652	1972-74	Barracuda	8.99 pr

Bumpers

New! **RESTORER'S CHOICE**

RESTORER'S CHOICE

New! **RESTORER'S CHOICE**

RESTORER'S CHOICE



MM1939



MM1932



MM1007



MM1012



MB184630



MB184627



MM1005



1967-74 Front Bumpers

Reproduction front bumpers for 1967-74 models. Your choice of a Restorer's Choice brand premium grade bumper that is officially licensed by Mopar or the standard replacement bumper for the car builder on a budget. Restorer's Choice bumpers are manufactured in heavier gauge steel and feature premium grade chrome plating as well as all original contours and details where applicable.

Note: Shipped double oversize.

852

Restorer's Choice

A-Body			
MM1000B	1967-69	Barracuda, w/o bumper guard holes	299.99 ea
MM1939	1967-69	Dart	329.99 ea
MM1932	1970-71	Dart	299.99 ea
MM1932	1971	Demon	299.99 ea
MM1921	1970-71	Duster without jack slots	299.99 ea
MM1922	1971-72	Duster with jack slots	299.99 ea
B-Body			
MM1007	1968-69	Charger (includes bumperettes)	349.99 ea
MM1924	1968-69	Coronet	409.99 ea
MM1012	1968-69	Plymouth B-Body	409.99 ea
MB184628	1970	Charger	399.99 ea
MM3171	1970	Plymouth B-Body	399.99 ea
MB184630	1971	Charger	399.99 ea
MB184626	1971	Plymouth B-Body	399.99 ea
MB184631	1972	Charger	399.99 ea
MB184627	1972	Plymouth B-Body	399.99 ea
E-Body			
MM1001	1970-71	Barracuda without jack slots	279.99 ea
MM1002	1972	Barracuda with jack slots	279.99 ea
MM1003	1973-74	Barracuda with jack slots	279.99 ea
MM1004B	1970-71	Challenger without jack slots	274.99 ea
MM1005	1972	Challenger with jack slots	279.99 ea
MM1006	1973-74	Challenger with jack slots	279.99 ea

Standard Replacement

A-Body			
MM1000A	1967-69	Barracuda, w/o bumper guard holes	249.99 ea
MM1986	1967-69	Barracuda, with bumper guard holes	249.99 ea
E-Body			
MM1004A	1970-71	Challenger without jack slots	219.99 ea



MM1930



MM1026



MM1023



MM1028



MM3172



MB184629



MM1016



MM1020

1967-74 Rear Bumpers

Reproduction rear bumpers for 1967-74 models. Your choice of our Restorer's Choice brand premium grade bumper that is officially licensed by Mopar or our standard replacement bumper for the car builder on a budget. Restorer's Choice bumpers are manufactured in heavier gauge steel and feature premium grade chrome plating as well as all original contours and details where applicable.

Note: Shipped double oversize.

852

Restorer's Choice

A-Body			
MM1000B	1967-69	Barracuda, w/o bumper guard holes	299.99 ea
MM1930	1968-69	Dart	299.99 ea
MM2026	1970	Dart, w/o jack slots	299.99 ea
MM1026	1970-71	Duster, without jack slots	299.99 ea
MM1027	1971-72	Duster, with jack slots	299.99 ea
MM2026	1971-72	Scamp without jack slots	299.99 ea
B-Body			
MM1023	1968-70	Charger (includes bumperettes)	349.99 ea
MM1028	1968	Plymouth B-Body	409.99 ea
MM1029	1969	Plymouth B-Body	409.99 ea
MM3172	1970	Plymouth B-Body	399.99 ea
MB184629	1971	Plymouth B-Body	399.99 ea
MM1923	1968-69	Coronet	409.99 ea
E-Body			
MM1015	1970-71	Barracuda, without jack slots	279.99 ea
MM1016	1972	Barracuda, with jack slots	279.99 ea
MM1017	1973	Barracuda, with jack slots	279.99 ea
MM1018	1974	Barracuda, with jack slots	279.99 ea
MM1019B	1970-71	Challenger, without jack slots	279.99 ea
MM1020	1972	Challenger, with jack slots	279.99 ea
MM1021	1973	Challenger, with jack slots	279.99 ea
MM1022	1974	Challenger, with jack slots	279.99 ea

Standard Replacement

A-Body			
MM1000A	1967-69	Barracuda, w/o bumper guard holes	249.99 ea
MM1986	1967-69	Barracuda, with bumper guard holes	249.99 ea
E-Body			
MM1019A	1970-71	Challenger, without jack slots	219.99 ea

Bumper Components

New!



1970-71 Barracuda Elastomeric Bumpers

Reproduction front and rear elastomeric bumpers for 1970-71 Barracuda models. Manufactured to factory specifications featuring original style contours, correct mounting points and a steel core coated in durable urethane.

Note: Shipped double oversize.

ME175919	1970	front	849.99	ea
ME175927	1970-71	rear	784.99	ea

New!



1963-72 Bumper Bracket Sets

Replace rusted, damaged or bent bumper brackets with these quality reproductions for 1963-72 models. Available in sets that include the necessary brackets needed to mount front and rear bumper or as partial sets.

Complete Front/Rear Bracket Sets

A-Body					
MM1067	1967-69	Barracuda	8-piece complete set	209.99 set
MM1072	1967-69	Dart	8-piece complete set	179.99 set
MM1073	1970-72	Duster	8-piece complete set	179.99 set
B-Body					
MM1070	1968-69	Charger	9-piece complete set	339.99 set
MM1074	1968-69	Plymouth	6-piece complete set	234.99 set
MM1075	1970	Plymouth	6-piece complete set	234.99 set
E-Body					
MM1068	1970-72	Barracuda	6-piece complete set	269.99 set
MM1069	1970-72	Challenger	6-piece complete set	249.99 set

Front Bumper Brackets

A-Body					
MP41275	1963-65	Valiant	stabilizer brackets	49.99 pr
MP41275	1964-65	Barracuda	stabilizer brackets	49.99 pr
MM1048	1967-69	Barracuda	front main "Y" bracket set	109.99 set
MM1076	1967-69	Barracuda	small "V" stabilizer brackets	24.99 pr
MM1054	1967-69	Dart	4-piece front bracket set	109.99 set
MM1055	1970-72	Duster	front "Y" bracket set	99.99 set
B-Body					
MM1051	1968-69	Charger	front main "Y" bracket set	149.99 set
MM1052	1968-69	Charger	center brace	74.99 ea
MM1077	1968-69	Charger	small corner stabilizer brackets	24.99 pr
MM1761	1968-69	Coronet	front "Y" bracket set	149.99 set
MM1056	1968-69	Plymouth	front "Y" bracket set	149.99 set
MM1057	1970	Plymouth	front "Y" bracket set	149.99 set
E-Body					
MM1049	1970-72	Barracuda	front "Y" bracket set	164.99 set
MM1050	1970-72	Challenger	front "Y" bracket set	164.99 set

Rear Bumper Brackets

A-Body					
MM1058	1967-69	Barracuda	rear main bracket set	89.99 set
MM1076	1967-69	Barracuda	small "V" stabilizer brackets	24.99 pr
MM1063	1967-69	Dart	4-piece rear bracket set	109.99 set
MM1064	1970-72	Duster	4-piece rear bracket set	84.99 set
B-Body					
MM1061	1968-70	Charger	rear bracket set	119.99 set
MM1062	1968-69	Coronet	rear bracket set	119.99 set
MM1065	1968-69	Plymouth	rear bracket set	119.99 set
MM1066	1970	Plymouth	rear bracket set	119.99 set
E-Body					
MM1059	1970-72	Barracuda	rear bracket set	119.99 set
MM1060	1970-72	Challenger	rear bracket set	119.99 set



1963-65 Plymouth B-Body Bumper Guards

Replacement bumper guards for the rear bumper on 1963 Plymouth models and 1965 Plymouth Belvedere models.

MB1871	1963, 65	bumper guards w/cushions	99.99 pr
MB1872	1963-65	cushions only	41.99 pr



1967 Dodge B-Body Bumper Guards

Replacement front and rear bumper guards for 1967 Charger and Coronet models. Features the correct chrome finish and mounts just like the original. Bumper cushions are included.

MB1869	1967	front	99.99 pr
MB1870	1967	rear	99.99 pr

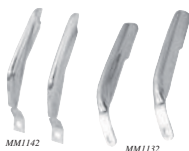

1968-70 Dodge Charger Chrome Bumper Guards

Replacement chrome bumper guards for 1968-70 Dodge Charger models. Each pair features bright chrome finish and correct configuration as original.

MM1142	1968-69	front	124.99 pr
MM1132	1968-70	rear	129.99 pr

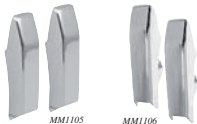

1970-72 E-Body Chrome Bumper Guards

Replacement chrome bumper guards for 1970-72 E-Body vehicles. Each pair features bright chrome finish and correct configuration as original.

MM1105	1970-72	Barracuda	rear	99.99 pr
MM1106	1970-72	Challenger	rear	99.99 pr

Bumper Components

New!



MF41276

MF1718

MB2183

MF1719



MB2184



MF1721



ME175917



MF1720



MF1722



ME1609

1966-72 Bumper Guard Cushions

These replacement bumper guard cushions are designed to replace your dried out or missing originals. These rubber bumper guard cushions are made to original specifications with steel reinforcements and studs (where applicable).

MP41276	1967-69	Barracuda - front or rear	79.99 pr
MF1718	1967-69	Dart - front or rear	114.99 pr
B-Body			
MB2183	1966	Charger, Coronet - front or rear	39.99 pr
MB2183	1967	Charger, Coronet - rear only	39.99 pr
MF1719	1968-69	Coronet/Superbee - front or rear	114.99 pr
MB2184	1970	Road Runner - front	139.99 pr
MF1720	1970	Roadrunner/GTX - rear	114.99 pr
MF1720	1970	Plymouth B-Body - rear	114.99 pr
MF1721	1970	Charger/Coronet/Superbee - front only	114.99 pr
MF1722	1970	Charger/Coronet/Superbee - rear only	114.99 pr
E-Body			
ME175917	1970-72	Challenger, 8" x 11/16" - front	21.99 pr
ME1609	1970-72	Challenger, 5-7/16" x 1" - rear	22.99 pr

New!



1970 Super Bee Front Bumper Fillers

Reproduction front bumper fillers for 1970 Dodge Super Bee models. Manufactured out of plastic featuring correct contours and factory style mounting points.

MB280965	1970		204.99 pr
----------	------	--	-----------



1970-72 Challenger Rear Bumper Filler

Rear bumper filler for 1970-72 Challenger models. This metal panel fits between the rear bumper and the tail lamp panel.

MM1256	1970-72		49.99 ea
--------	---------	--	----------



1970-71 Challenger Front Bumper Filler

Rubber bumper end filler for front bumper on 1970-71 Challenger models. Measures 3-5/8" long and 1-1/2" wide. Manufactured in rubber for an original fit and appearance.

ME1608	1970-71		39.99 pr
--------	---------	--	----------



1970-71 Barracuda Bumper Guard Filler

These bumper guard fillers install in the area between the bumper guard and the rear valance. Replace cracked, torn or missing fillers for a brand new look.

MN1820	1970-71		26.99 pr
--------	---------	--	----------



MB2180

1963-67 B-Body Rear Bumper Filler Seals

Rear bumper filler seal for various models. Manufactured in rubber to original specifications for an original fit and appearance. Made in USA.

Dodge 330, 440, Polara			69.99 pr
MB2180	1963-64		59.99 ea
Belvedere, Savoy, Valiant			59.99 ea
MB2181	1963-65		94.99 ea
Charger			
MB2182	1966-67		94.99 ea



MM1789

MM1790

1970-72 E-Body Bumper Guard Brackets

Rear bumper guard brackets for 1970-72 Barracuda and Challenger models. Manufactured from heavy gauge steel, these brackets mount to the rear frame rails.

Important: These brackets can be used on 1973-74 models when converting to a 1970-72 rear bumper with bumper guards.

MM1789	1970-72	Barracuda	34.99 set
MM1790	1970-72	Challenger	34.99 set

1962-74 Bumper Bolts

Replacement bumper bolts for various 1962-74 Mopar models.

These stainless bolts are used on both the front and rear and feature the correct style head. Each bolt includes a hex nut.

MM1700	1962-74	3/8" - 16 x 1	1.49 ea
MM1701	1962-74	7/16" - 14 x 1	1.49 ea



MM1701

Grills & Headlamp Bezels

OE AUTHORIZED AUTHENTIC REPRODUCTION



2786668 2786669 MA9901 MA9900

1967-72 A-Body Headlamp Bezels

Factory-style reproduction headlamp bezels for 1967-72 A-Body models. Manufactured from stamped aluminum with black accents as original.

Dodge Dart	1967	LH & RH	149.99 pr
MA1128	1967	LH	99.99 ea
2786669	1968	RH	99.99 ea
2786668	1968	RH	99.99 ea
MA9900	1969	LH	99.99 ea
MA9901	1969	RH	99.99 ea
Plymouth Duster			
3573719	1971-72	LH - black	119.99 ea
3573718	1971-72	RH - black	119.99 ea
3443223	1971-72	LH sharktooth - argent	119.99 ea
3443222	1971-72	RH sharktooth - argent	119.99 ea

New!

OE AUTHORIZED



2949246 2949247

1969-70 Road Runner Headlamp Bezels

Reproduction headlamp bezels for 1969 Road Runner models. Designed using factory specifications, each all-new bezel features the correct shape, stainless steel and black finish and proper mounting points.

2949247	1969	LH	109.99 ea
2949246	1969	RH	109.99 ea
2998013	1970	LH	99.99 ea
2998012	1970	RH	99.99 ea

New!



MB143510

1968-69 Charger Headlamp Bezels

Reproduction headlamp bezels for 1968-69 Charger models. These bezels surround the headlamps when the headlamp doors are opened. Manufactured in injected plastic resin for durability and an original appearance. Made in the USA.

MB143511	1968	black w/silver trim	269.99 pr
MB143510	1968-69	black	189.99 pr
MB143512	1969	black w/silver trim	239.99 pr

New!



2998014

2998015

OE AUTHORIZED AUTHENTIC REPRODUCTION

OE AUTHORIZED

1970 GTX Headlamp Bezels

Reproduction headlamp bezels for 1970 GTX models. Original style bezels feature the correct honeycomb grill pattern with stainless steel and black finish.

2998015	1970	LH	99.99 ea
2998014	1970	RH	99.99 ea

New!

OE AUTHORIZED AUTHENTIC REPRODUCTION



ME1541

ME1544

1970-74 Barracuda Headlamp Bezels

Reproduction headlamp bezels for 1970-74 Barracuda models. Manufactured in OE specifications, these factory-style reproductions will fit, function and look like original equipment.

ME1541	1970	textured argent	344.99 set
ME175944	1970	unpainted - LH	89.99 ea
ME175945	1970	unpainted - RH	89.99 ea
ME1542	1971	chrome	214.99 set
ME1543	1971	black	104.99 set
ME1544	1972-74	black w/chrome accents	129.99 set

OE AUTHORIZED AUTHENTIC REPRODUCTION



ME1545

1970-74 Challenger Headlamp Bezels

Reproduction headlamp bezels for 1970-74 Challenger models. Manufactured in aluminum with correct black, argent or chrome finish to OE specifications, these factory-style reproductions will fit, function and look like original equipment.

ME8159	1970	argent finish	standard models	444.99 pr
ME1545	1970	black finish	R/T models	374.99 pr
ME1856	1971	argent finish	standard models	444.99 pr
ME1857	1971	black finish	R/T models	444.99 pr
ME1288	1972-74	chrome metal		144.99 set



MN1792

1968-70 Grill Spacer Sets

Replacement grill hardware for various 1968-70 A, B and E-Body models. Available as a spacer set in black or white or a hardware screw set, these components will make replacing the grill simple! Includes all required mounting hardware.

Grill Spacer Set

MN1792	1968-69	Barracuda	black	49.99 set
MN1793	1968-69	Barracuda	white	49.99 set
MN1792	1968-70	Charger	black	49.99 set
MN1793	1968-70	Charger	white	49.99 set



MA2467

1968-69 Barracuda Grill Sets & Components

Replacement grill and components for 1968-69 Plymouth Barracuda models. Available in a set or as individual components. The 1968 grill set includes the grill screens, grill trim, and the headlamp bezels. The 1969 grill set includes the grill screens, inner and outer grill trim, and the grill housing.

Grill Sets

RM4133	1968	grill set	1016.99 set
RM4134	1969	grill set	1871.99 set

Individual Components

MA2465	1968	grill screen	204.99 pr	
MA1158	1968	grill screen trim	inner	204.99 pr
MA4737	1968	headlamp bezel	454.99 pr	
MA1156	1969	grill screen	414.99 pr	
MA1157	1969	grill screen trim	inner	149.99 pr
MA4738	1969	grill screen trim	outer	624.99 pr
MA2467	1969	grill housing	624.99 pr	

Grills

New!

OPR AUTHENTIC RESTORATION



MA1000



3574031



2949968



2949970



3443540



MA1181

3478549



3513307



MA4743

1971-72 Duster "Sharktooth" Grill & Components

Reproduction "Sharktooth" front grill as featured on the 1971-72 Plymouth Duster 340 and Duster models equipped with the Twister appearance package. Manufactured to factory specifications to duplicate the appearance and fit of the originals. Order the fully assembled grill that is ready to install or choose from the individual components as needed. Officially licensed Mopar Authentic Restoration Product.

Note: Will fit all 1970-72 Duster models, but is only cosmetically correct for 1971-72.

MA1000*	1971-72	fully assembled	1232.99 ea
3574031	1971-72	grill only	699.99 ea
2949968	1971-72	grill molding - upper	129.99 ea
2949970	1971-72	grill molding - lower	129.99 ea
3443540	1971-72	grill retaining clips - set of 5	24.99 set
MA1181	1971-72	park lamp lenses	184.99 set
3478549	1971-72	park lamp lens gasket	8.99 pr
3513307	1971-72	park lamp pigtail	26.99 ea
MA4743	1971-72	park lamp hardware (8 piece)	14.99 set

New!

OPR AUTHENTIC RESTORATION



2786047

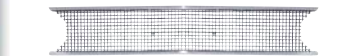

MN1492

1968-69 Dodge Grills

Reproduction grills for 1968 Dodge A-Body and 1968-69 Dodge B-Body models. Each grill is manufactured to original specifications and will replace your factory grill without modifications.

Note: *Shipped oversize.

A-Body				
2786047*	1968	Dart	aluminum grill w/blk accents	599.99 ea
B-Body				
MN1493	1968	Coronet	silver grill	349.99 ea
MN1492	1968	Super Bee	silver grill	349.99 ea
MN1492	1968	Coronet R/T	black grill	349.99 ea
MN1492	1968	Coronet 500	black grill	349.99 ea
MN1492	1969	Charger 500	black grill	349.99 ea

OPR AUTHORIZED

OPR AUTHENTIC RESTORATION



RM4130



MB2169



RM4131

1969-70 Plymouth B-Body Grill Sets

Reproduction grill sets for 1969-70 Plymouth B-Body models. Designed to fit and function exactly as original.

1969 & 1970 Road Runner Grill Sets

Grill for 1969 and 1970 Road Runner models. Features correct black and stainless steel finish and correct mounting points. Replace your damaged original grill. Includes center grill and headlamp bezels.

Note: Shipped double oversize.

MB2169	1969	409.99 set
RM4130	1970	494.99 set

1970 GTX Grill Set

Grill for 1970 GTX models. Features the correct black honeycomb pattern, stainless steel finish and correct mounting points. Replace your damaged original grill. Includes center grill and headlamp bezels.

Note: Shipped double oversize.

RM4131	1970	494.99 kit
--------	------	------------

New!



MB143505

1968-69 Charger Grills

Reproduction grill sets for 1968-69 Charger models. Manufactured in injected black plastic resin for durability and an original appearance. Your choice of either an all black painted grill or painted with the correct argon silver accents. Set includes center grill, LH and RH grill extensions along with the LH and RH headlamp doors. Made in USA

Note: Ships oversize.

1968-69 Charger Grill Sets

1968 Charger Grills			
MB143503	1968	black	w/o headlamp door brackets 929.99 set
MB143504	1968	black	w/ headlamp door brackets 999.99 set
MB143501	1968	silver	w/o headlamp door brackets 969.99 set
MB143502	1968	silver	w/ headlamp door brackets 1049.99 set

1969 Charger Grills

MB143507	1969	black	w/o headlamp door brackets 929.99 set
MB143508	1969	black	w/ headlamp door brackets 999.99 set
MB143505	1969	silver	w/o headlamp door brackets 969.99 set
MB143506	1969	silver	w/ headlamp door brackets 1049.99 set

1968-69 Charger Headlamp Door Brackets

Replacement headlamp door hinge brackets for 1968-69 Charger models. Manufactured in steel and painted black for an original appearance. Includes rivets for installation. Made in the USA

MB143509	1968-69	headlamp door hinge brackets	69.99 set
----------	---------	------------------------------	-----------

New!

OPR AUTHORIZED



1969 Road Runner Grill

Reproduction grill for the 1969 Plymouth Road Runner. This high quality reproduction grill features the correct flat black finish in the recessed areas and dark gray accents. Manufactured to original specifications to ensure a proper fit and correct appearance.

Note: Shipped oversize.

2947007	1969	259.99 ea
---------	------	-----------

Grills



MM1788B

MB1906

1968-70 Plymouth B-Body Lower Grills

Lower grill panels for 1968-70 Plymouth B-Body models. 1968-69 panel is EDP coated and manufactured from heavy gauge steel. Your choice of our Restorer's Choice lower grill, officially licensed by Mopar and manufactured in OE-gauge steel featuring all original contours and details or our standard replacement for the car builder on a budget. The 1970 panel is manufactured from ABS plastic with correct painted silver edge and black center.

Note: Shipped double oversize.

MM1788B	1968-69	Restorer's Choice	129.99 ea
MM1788A	1968-69	standard replacement	99.99 ea
MB1906	1970		99.99 ea



ME1852



ME1853



ME1854

1970-74 Challenger Grill Assemblies & Components

Grill assembly and components for 1970-74 Challenger models. Features correct chrome trim, and mounting points. Order individual components or the complete assembly, including the grill surround and filler panel for an easy bolt-on installation. Can be painted to match other models. Paint to match.

Note: Shipped double oversize.

ME1852	1970	complete grill assembly - paint to match	649.99 ea
ME1552	1970	grill only - paint to match	319.99 ea
ME1553	1972-74	grill only - paint to match	124.99 ea
ME1853	1970	grill surround	104.99 ea
ME1854	1970	grill filler panel	298.99 ea

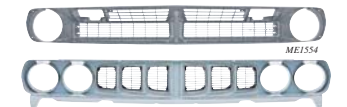

ME1554

1970-71 Barracuda Grill Sets

MN2191

Classic Industries® offers complete grill sets for 1970-71 Plymouth E-Body models. Each grill is manufactured to factory specifications compatible with original trim or reproduction trim.

1970 Barracuda Complete Grill Assembly

Grill assembly for 1970 Barracuda models. These include the parking lamp assembly, headlamp bezels, stainless trim and Plymouth emblem. The standard grill features correct gray paint and red bars.

Note: Shipped double oversize.

ME1547	1970	Barracuda, 'Cuda	gray	1294.99 ea
--------	------	------------------	------	------------

1970-71 Barracuda Grill and Headlamp Bezel Set

Grill for 1970-71 Barracuda models. This quality replacement features correct contours, mounting points and includes headlamp bezels, upper trim, lower trim and the headlamp bezel trim.

Note: Grills are unassembled and unpainted. Shipped double oversize.

ME1554	1970	Barracuda, 'Cuda	paint to match	514.99 set
MN2191	1971	Barracuda, 'Cuda	paint to match	699.99 set

New!



1970 Barracuda Grill

Reproduction center grill for 1970 Barracuda models. Manufactured to factory specifications featuring original style mounting points, park lamp provisions, and trim attachment points. Must be painted to match original.

Note: Shipped oversize.

ME175948	1970	unpainted	269.99 ea
----------	------	-----------	-----------

New!



1971 Barracuda Grill Screen Clips

Reproduction grill screen clips for 1971 Barracuda models. These small rectangular clips are what secure the six grill screens to the grill assembly.

MN8057	1971		24.99 set
--------	------	--	-----------

New!



MN1860

1964-76 Complete Grill Hardware Sets

Replacement grill hardware for various 1964-76 A, B and E-Body models. Every grill mounting set includes all the necessary hardware to mount the grill assembly on the vehicle specified.

A-Body

MN3070	1964	Dart	18.99 set
MN3083	1966	Barracuda/Volant	50.99 set
MN3084	1967-68	Barracuda	27.99 set
MN3071	1967-68	Dart	28.99 set
MN2151	1969	Barracuda	27.99 set
MN3072	1969	Dart	36.99 set
MN3073	1970-71	Dart	24.99 set
MN3075	1970-71	Duster	19.99 set
MN3073	1971	Demon	24.99 set
MN3074	1972	Dart/Demon	28.99 set
MN3076	1972	Duster	22.99 set
MN3077	1973-76	Duster	26.99 set

B-Body

MN3078	1965	Coronet	17.99 set
MN3079	1967	Coronet	48.99 set
MN3080	1968	Coronet/Super Bee	29.99 set
MN3081	1969	Coronet/Super Bee	32.99 set
MN3082	1970	Coronet/Super Bee	26.99 set
MN3085	1966-67	Charger	60.99 set
MN3086	1968-69	Charger	52.99 set
MN3087	1970	Charger	48.99 set
MN3088	1971-72	Charger	18.99 set
MN3089	1966	Satellite	39.99 set
MN3090	1967	Satellite/GTX/Belvedere	49.99 set
MN3091	1968	Satellite/Road Runner	39.99 set
MN3092	1968	GTX/Sport Satellite	39.99 set
MN1860	1969	Plymouth B-Body - except GTX	34.99 set
MN3093	1969	GTX/Sport Satellite	29.99 set
MN3094	1970	Plymouth B-Body - except GTX/Sport Satel	37.99 set
MN3101	1971-72	Charger	19.99 set

E-Body

MN3095	1970	Barracuda	64.99 set
MN3096	1971	Barracuda	47.99 set
MN3097	1972-74	Barracuda	42.99 set
MN1870	1970	Challenger	44.99 set
MN3098	1971	Challenger	24.99 set
MN3099	1971	Challenger R/T	24.99 set
MN3100	1972-74	Challenger	34.99 set

Valance Panels & Spoilers



1967-74 Front Valance Panels

Factory-style replacement front valance panels for various 1967-74 models. This panel mounts below the front bumper. Your choice of our "Restorer's Choice" panel, officially licensed by Mopar, manufactured in OE-gauge steel featuring all original contours, details and mounting points or our standard replacement for the car builder on a budget. Either choice comes finished in black EDP coating to prevent rust and is ready to prep, prime and paint to your desired color.

Note: Shipped double oversize.

Restorer's Choice

A-Body	
MM1081	1967-69 Barracuda.....224.99 ea
MM1757	1970-72 Dart/Demon.....279.99 ea
B-Body	
MB280989B	1963 Dodge.....349.99 ea
MM1083B	1968-69 Charger.....259.99 ea
MM1773	1970 Charger.....259.99 ea
MM1084	1971-72 Charger.....259.99 ea
MM1085	1973-74 Charger.....259.99 ea
MM1774	1971-72 Road Runner.....344.99 ea
E-Body	
MM1082B	1970 Barracuda.....224.99 ea
MM1013	1971 Barracuda.....344.99 ea
MM1082B	1972-74 Barracuda.....224.99 ea
MM1759B	1970-71 Challenger.....224.99 ea
MM1760	1972-74 Challenger.....204.99 ea
Standard Replacement	
MM1083A	1968-69 Charger.....169.99 ea
MM1082A	1970 Barracuda.....169.99 ea
MM1082A	1972-74 Barracuda.....169.99 ea
MM1759A	1970-71 Challenger.....169.99 ea



1967-74 Front Valance Panel Hardware Sets

Reproduction front valance panel hardware sets for various 1967-74 models. Manufactured to factory specifications every set includes all the necessary hardware to mount the front valance.

MN3069	1967-69 Barracuda.....14.99 set
MN3056	1968-69 Charger.....18.99 set
MN3057	1970 Charger/Coronet.....32.99 set
MN3058	1971 Charger.....29.99 set
MN3059	1971 Plymouth B-Body.....16.99 set
MN3060	1970-71 E-Body.....16.99 set
MN3061	1972-74 E-Body.....16.99 set



1968-70 B-Body Front Bumper Lower Stone Shield

Front bumper lower stone shield for 1968-70 models. Replace your missing shield with this EDP coated panel that installs between the front bumper and radiator core support.

MM1078	1968-69 Coronet/Super Bee.....94.99 ea
MM1079	1968-69 Plymouth B-Body.....94.99 ea
MM1080	1970 Plymouth B-Body.....94.99 ea



1970-71 Barracuda Front Valance Filler

Front valance panel fillers for 1970-71 Barracuda models. These panels are molded plastic like the originals and feature the correct color. Mounts between the front lower valance panel and the front bumper.

Note: *Shipped oversize.

ME1565*	1970	gray.....169.99 ea
ME1566	1971	black.....194.99 ea



1971-74 B-Body Front Spoilers



Quality reproduction full length one piece and boomerang front spoilers for 1971-74 Plymouth B-Body models. These reproductions are molded in black polyethylene plastic as original and are superior in durability to incorrect fiberglass replacements. Correct mounting hardware is included. Made in the USA.

Full Length One Piece Spoilers

Important: Although these spoilers were originally only offered for 1971 models, they will fit all 1971-74 Charger and 1971 Super Bee models.

Note: Shipped double oversize.

MB2333	1971-74	Charger full length front spoiler.....189.99 ea
--------	---------	---

B-Body Boomerang Style Spoilers

Important: Although these spoilers were originally only offered in 1971, they will fit all 1971-72 B-Body 2 door vehicles.

MB2334	1971-72	Plymouth B-Body boomerang spoilers.....79.99 pr
--------	---------	---



1970-74 E-Body Front Spoilers

Correct reproduction front spoilers for 1970-74 E-Body models. These spoilers are molded in black polyethylene plastic as original and are superior in durability to fiberglass replacements. Mounting hardware included. Made in USA.

Important: Although these spoilers were originally only offered for 1970-71 models, ME1647 will fit all 1970-74 Challenger models and ME1648 will fit all 1970-74 Barracuda models.

ME1647	1970-74	Challenger T/A.....79.99 pr
ME1648	1970-74	AAR Cuda.....59.99 pr

1970-71 B & E-Body

Front Spoiler Mounting Hardware

Mounting hardware for all 1970-71 B-Body & E-Body models equipped with factory or replacement spoilers. Replace your damaged or missing hardware with all new correct hardware.

MD2214	1970-7112.99 set
--------	---------	----------------

Header/Radiator Support Panels



1968-69 Charger Grill/Headlamp Support

Reproduction of the grill/headlamp support for 1968-69 Charger models. This EDP coated piece features the upper crossbar, lower crossbar, hood lock support, and the headlamp buckets.

Note: Shipped truck freight.

MB1863 1968-69 369.99 ea



1970-74 E-Body Inner Headlamp Splash Shield

Replacement inner headlamp splash shields for 1970-74 E-Body models. These pieces are bolted behind the headlamp buckets and feature correct contours and mounting points.

ME8128 1970-74 all models (except 1971 Barracuda) 104.99 pr
ME8129 1971 Barracuda only 134.99 pr



1970-74 Barracuda Header Panel

Factory-style replacement header panel for 1970 Barracuda models. This panel mounts just forward of the hood to complete the front end. Your choice of our "Restorer's Choice" panel, officially licensed by Mopar, manufactured in OE-gauge steel featuring all original contours, details and mounting points or our standard replacement for the car builder on a budget. Either choice comes finished in black EDP coating to prevent rust and is ready to prep, prime and paint to your desired color.

Note: Shipped double oversize.

Restorer's Choice		
MM1102B	1970.....	359.99 ea
MM1103B	1971.....	294.99 ea
MM1104	1972-74.....	294.99 ea

Standard Replacement		
MM1102A	1970.....	289.99 ea
MM1103A	1971-74.....	194.99 ea

New!



1971-74 Barracuda Header Panel Bolt Set

Reproduction header panel mounting bolt set for 1970-74 Barracuda models. Manufactured to factory specifications, every bolt set includes all necessary hardware to mount the header panel.

MN2890 1970-71 11.99 set
MN2891 1972-74 9.99 set



1966-74 B & E-Body Radiator Support Braces

K-member to radiator support brace for 1966-70 B-Body models and radiator support brace for B-Body & E-Body models. These stamped steel pieces will replace your damaged or rusted original exactly.

B-Body

MM1121 1966-70 K-member to radiator support bracket 29.99 ea
MM3047 1971-74 radiator support brace 104.99 ea

E-Body

MM3047 1970-74 radiator support brace 104.99 ea



1966-74 B-Body and E-Body Radiator Support

Radiator support, mounted directly behind the grill area where the radiator mounts. Each support is ready to install and features pre-drilled holes for easy installation.

Note: Shipped double oversize.

B-Body		
MM1133	1966-68 assembly	339.99 ea
MM1134	1969-70 assembly	339.99 ea
MM1135	1966-70 lower panel	178.99 ea
MM1136	1971-72 assembly	339.99 ea
MM1137	1971-72 lower panel	189.99 ea
E-Body		
MM1136	1970-74 assembly	339.99 ea
MM1137	1970-74 lower panel	189.99 ea

Hood Panels



AUTHENTIC
RESTORATION
CORPORATION

1967-69 Dart GTS Hood

Reproduction hood for 1967-69 Dodge Dart models. This GTS style hood is manufactured in OE-gauge steel featuring all original contours, bracing and details.
Note: Shipped truck freight.

MM1024 1967-69 GTS style 544.99 ea

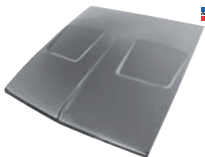

AUTHENTIC
RESTORATION
CORPORATION

1968-69 Charger Hood

Reproduction hood for 1968-69 Dodge Charger. Manufactured in OE-gauge steel featuring all original contours, bracing and details.

Note: Shipped truck freight.
MM1113 1968-69 639.99 ea

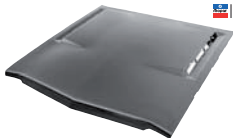

AUTHENTIC
RESTORATION
CORPORATION

1968-69 B-Body Hood with Louver Opening

Reproduction hood for 1968-69 Plymouth B-Body models. Manufactured in OE-gauge steel featuring all original contours, bracing and details.

Note: Shipped truck freight.
MM1114 1968-69 w/louver openings 694.99 ea

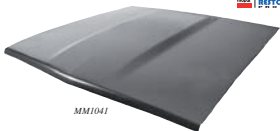

AUTHENTIC
RESTORATION
CORPORATION

MM1041

1970 B-Body Hoods

Reproduction hoods for 1970 Plymouth B-Body models. Manufactured in OE-gauge steel featuring all original contours, bracing and details.

Note: Shipped truck freight.
MM1008 1970 standard hood, w/o hood pin holes 669.99 ea
MM1009 1970 standard hood, w/hood pin holes 669.99 ea
MM1041 1970 fresh air style, w/o hood pin holes 748.99 ea

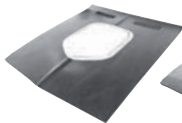

MM115B



MM117B

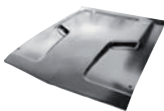

MM1118

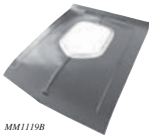

MM119B



MM1917

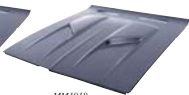

MM1918

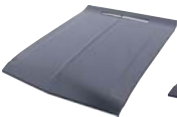

MM1919



MM1920

RESTORER'S
CHOICE™

1970-74 E-Body Hoods

Reproduction hoods for 1970-74 Dodge and Plymouth E-Body models. Your choice of our Restorer's Choice hoods, officially licensed by Mopar and manufactured in OE-gauge steel featuring all original contours, bracing and details or our standard replacement for the car builder on a budget.
Note: Shipped truck freight.

Restorer's Choice

Barracuda			
MM115B	1970-74	Shaker style	w/o hood pin holes 899.99 ea
MM1116	1970-74	Shaker style	w/hood pin holes 899.99 ea
Challenger			
MM1117B	1970-74	R/T style	w/o hood pin holes 494.99 ea
MM1118	1970-74	R/T style	w/hood pin holes 494.99 ea
MM119B	1970-74	Shaker style	w/o hood pin holes 899.99 ea

Standard Replacement

Barracuda			
MM115A	1970-74	Shaker style	w/o hood pin holes 699.99 ea
MM1917	1970-74	standard hood	w/o hood pin holes 484.99 ea
MM1918	1970-74	twin bulge	w/o hood pin holes 499.99 ea
Challenger			
MM117A	1970-74	R/T style	w/o hood pin holes 429.99 ea
MM119A	1970-74	Shaker style	w/o hood pin holes 699.99 ea
MM1919	1970-71	standard hood	w/o hood pin holes 484.99 ea
MM1920	1972-74	standard hood	w/o hood pin holes 499.99 ea

Hood Components



1970-74 E-Body Hood Latch Assemblies

Replacement hood latch assembly for 1970-74 Barracuda and Challenger models. This piece is EDP coated for rust prevention and will install just like the original. Features the correct latch, hood pop-up spring and support brace.

MM1925	1970-74	Barracuda.....	149.99	ea
MM1926	1970-74	Challenger.....	149.99	ea



1970-74 B & E-Body Hood Latch Support

Replacement hood latch support for 1971-72 two door Plymouth B-Body and 1970-74 E-Body models. This brace is EDP coated for rust prevention and features correct mounting points.

MM1927	1971-72	B-Body.....	44.99	ea
MM1927	1970-74	E-Body.....	44.99	ea

1966-74 Hood Pop-Up Spring

Replacement hood pop-up spring for various 1966-74 B-Body and 1970-74 E-Body models. This is the spring that pops open the hood when the latch is released.



MD1614

B-Body Models

MD1613	1966-67	exc. Charger.....	9.99	ea
MD1614	1966-70	exc. Charger.....	8.99	ea
MD1615	1970	Charger.....	11.99	ea
MD1615	1971-74	all.....	11.99	ea

E-Body Models

MD1615	1970-74	all.....	11.99	ea
--------	---------	----------	-------	----



1967-68 Dart/Coronet Hood Latch

Replacement of the original hood latch for 1967-68 Dodge Dart models and 1967 Dodge Coronet models.

2802432	1967-68	Dart.....	69.99	ea
2802432	1967	Coronet.....	69.99	ea

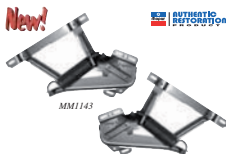

1968-74 B & E-Body Hood Hinges

Replace your original bent hood hinges with these quality steel reproductions for 1968-74 B-Body and E-Body models. Hinge springs are included.

MM2043	1968-70	B-Body.....	218.99	pr
MB280974	1971-74	B-Body.....	249.99	pr
MM1143	1970-74	E-Body.....	249.99	pr



CB45201



CB03

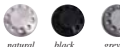

natural black grey

1966-70 B-Body Billet Hood Hinges

Replace your functional but unsightly original hood hinges with a set of premium quality billet hood hinges. CNC machined from solid 6061-T6 billet aluminum, these hinges feature ball bearing pivot joints and gas shocks either as a solid frame hinge or the new high tech air frame. Installation hardware and instructions included. Available in natural, black or grey anodized aluminum finishes and for steel or fiberglass hoods.

Solid Arm Style

Natural Aluminum				
CB45101	1966-70	steel hood.....	649.99	pr
CB45102	1966-70	fiberglass hood ...	649.99	pr
Anodized Black				
CB45103	1966-70	steel hood.....	749.99	pr
CB45104	1966-70	fiberglass hood....	749.99	pr

Anodized Grey				
CB45105	1966-70	steel hood.....	749.99	pr
CB45106	1966-70	fiberglass hood....	749.99	pr

Air Frame Style

Natural Aluminum				
CB45201	1966-70	steel hood.....	649.99	pr
CB45202	1966-70	fiberglass hood....	649.99	pr
Anodized Black				
CB45203	1966-70	steel hood.....	749.99	pr
CB45204	1966-70	fiberglass hood....	749.99	pr

Anodized Grey				
CB45205	1966-70	steel hood.....	749.99	pr
CB45206	1966-70	fiberglass hood....	749.99	pr

Replacement Hood Shocks

Anodized Black				
CB16	1966-70	steel hood.....	89.99	pr
CB03	1966-70	fiberglass hood....	49.99	pr



FB2050NF

1966-70 B-Body Billet Hood Hinges

Looking for an eye catching mod for your classic Mopar? Replace your original stamped steel hood hinges with these beautiful billet aluminum hinges with gas struts. Hinges are made using the finest quality 6061 T6 aluminum and use weatherproof bearings and stainless steel hardware to ensure smooth, effortless operation in any climate. Each hinge is machined to perfection in a manner which is not only fully functional but also visually appealing. Comes with black carbon steel struts and mounting hardware. Available in polished, black anodized or natural finish. Fits 1966-70 Charger, 1967-70 Coronet, 1967-70 GTX, 1968-70 Super Bee & 1968-70 Road Runner.

Polished Aluminum	
FB2050PF	1966-70 for fiberglass hood .. 849.99 set
FB2050PS	1966-70 for steel hood 849.99 set
Anodized Black	
FB2050BF	1966-70 for fiberglass hood .. 849.99 set
FB2050BS	1966-70 for steel hood 849.99 set
Natural Aluminum	
FB2050NF	1966-70 for fiberglass hood .. 749.99 set
FB2050NS	1966-70 for steel hood 749.99 set



MB281025M

1966-70 B-Body Billet Hood Hinges

These hood hinges are CNC-machined from high quality 6061-T6 billet aluminum. Nitrogen-filled stainless steel gas struts and sealed bearings. Each pair includes stainless steel gas struts and mounting hardware. Made in the USA.

Steel Hood	
MB281025B	1966-70 black anodized .. 644.99 pr
MB281025M	1966-70 matte black..... 644.99 pr
MB281025C	1966-70 clear anodized .. 644.99 pr
MB281025R	1966-70 raw machined.... 534.99 pr
MB281025P	1966-70 polished..... 594.99 pr
Fiberglass Hood	
MB281026B	1966-70 black anodized .. 644.99 pr
MB281026M	1966-70 matte black..... 644.99 pr
MB281026C	1966-70 clear anodized .. 644.99 pr
MB281026R	1966-70 raw machined.... 534.99 pr
MB281026P	1966-70 polished..... 594.99 pr



1970-74 Spring Hood Wedges

Replacement spring-loaded hood wedges for 1971-74 B-Body and 1970-74 E-Body models. Hood wedges mount on each side of the hood to keep it aligned.

MD2601	1971-74	B-Body.....	15.99	pr
MD2601	1970-74	E-Body.....	15.99	pr

Hood Pins



Made in USA

1969 A12 B-Body Hood Pin Brackets

Replacement lift-off hood pin brackets for 1969 B-Body models with the A12 440 6 bbl package. These brackets are welded and dipped in red oxide primer, ready for paint. Made in USA.

MB1865 1969..... 34.99 pr



1970-74 Barracuda Hood Pin Brackets

Hood pin brackets for 1970-74 Barracuda Models. These brackets are mounted to the core support, creating a mounting point for each of the hood pins.

MM1838 1970-74..... 54.99 pr

Authentic Reproduction



MD600331

1969-74 Hood Pin Sets

Authentic reproduction hood pin sets for 1969-74 B and E-Body models and 1970-71 Duster and Scamp models. Each component is manufactured to replicate the originals in every detail. Sets include bezels, gaskets, studs, lanyards and hardware. For steel hood applications only.

Hood Pin Sets

A-Body	1970-71	Duster/Scamp	59.99 set
MD600331	1969-74	with 18" lanyard	44.99 set
MD600332	1969-74	with 23" lanyard	44.99 set
MD600333	1969-74	with 25" lanyard	49.99 set

Components

Bezels			
MD600334	1969-74	bezels & gaskets	24.99 set
Lanyards			
MD600335	1969-74	13" lanyard	19.99 pr
MD600336	1969-74	18" lanyard	19.99 pr
MD600337	1969-74	23" lanyard	19.99 pr
MD600338	1969-74	25" lanyard	19.99 pr
Hood Pin Clips			
MD600339	1969-74	hood pin clips	11.99 pr
Pin Studs			
MD600340	1969-74	3.38" pins	16.99 pr
MD600341	1969-74	4" pins	16.99 pr



Made in USA

Quick Release Billet Hood Pin Set

Replace those old, rusty chrome hood pins on your Mopar with a pair of ultra-trick, CNC machined aluminum hood pins from Hotchkis Sport Suspension.

The hard anodized finish gives a hi-tech look to your car. The kit comes complete with aluminum pins, stainless hardware, hood pin plates, and a trick aluminum quick release pin. Made in USA.

Important: These hood pins feature a flat design for non-contoured hoods.

Note: No further discounts apply.

H1760 all..... 199.99 set

SHOCKED BY THE PRICE?



HP5001



HP5002



HP5003

with stainless screws

Made in USA

Billet Aluminum Hood Pin Sets

You've gone to great lengths to source the highest quality and best looking parts for your classic Mopar, so why settle for cheap, imported hood pins to finish off such a highly-visible part of your car? These US-made, 6061-T6 aluminum hood pin and scuff plate sets will help your car stand out in a crowd and complement any style hood. The billet scuff plates are available in your choice of machined, polished, or powder-coated black finish. All hood pin sets include 6" aluminum pins and stainless steel hardware (black sets also include black oxide screws,) so you'll never have to worry about rust.

Note: Late-model applications may require angled-hood scuff plates as the hood may be sloped directly above the radiator support.

Hood Pins With Machined Scuff Plates

HP5001 standard hood..... 99.99 set

Hood Pins With Polished Scuff Plates

HP5002 standard hood..... 109.99 set

Hood Pins With Black Powder Coated Scuff Plates

HP5003 standard hood..... 119.99 set



CB40046

CB40047

CB40048

Made in USA

Ringbrothers Billet Hood Pins

Give the outside of your ride some high tech flair with these Ringbrothers billet hood pins. Machined from 6061-T6 billet aluminum, these hood pins feature a base screws into core support for easy installation and includes stainless steel locking pin for secure closure. Locking pin adjusts to the angle of the hood. Installation hardware and instructions included. Sold in pairs, available in natural, black and grey finish. Made in USA.

CB40046 natural..... 249.99 pr

CB40047 black..... 249.99 pr

CB40048 grey..... 249.99 pr



25109P



25109B



25110B

Made in USA

25113C

Universal Simulated Hood Pins

Get the look of billet hood pins without having to drill holes in your expensive hood. Machined billet plate from 6061-T6 aircraft aluminum, stainless steel pins, screws and cables. Installs in minutes with no tools, just peel and stick. Available in classic or striker design. 24" cables sold separately. Made in USA.

Note: These are non-functioning hood pins.

25109P	classic	polished	54.99 set
25109B	classic	black	54.99 set
25110P	striker	polished	54.99 set
25110B	striker	black	54.99 set
25113R	24" cables	red	16.99 pr
25113B	24" cables	black	16.99 pr
25113C	24" cables	clear (silver)	16.99 pr

Hood Seals and Insulation

New!



MB2342



ME2236



1966-76 Molded Hood Insulation

Hood insulation produced with the correct molds on both sides and supplied with pre-punched clip holes for a easy installation. Hood insulation reduces engine noise outside of the vehicle while also protecting the hood from high engine temperatures. Clips sold separately. Made in USA.

Note: *Shipped oversize. **Shipped double oversize.

MA2231	1967-76	A-Body	89.99 ea
MB2341	1966-67	B-Body	89.99 ea
MB2342*	1968-69	B-Body	89.99 ea
MB2343*	1970	B-Body	89.99 ea
MB2346*	1971-74	B-Body - except Charger	89.99 ea
ME2236	1971-74	Charger	89.99 ea
ME2236	1970-74	E-Body	89.99 ea



MA340



MD341



1966-76 Die-Cut Hood Insulation

Replace your missing or oil-soaked hood insulation with a high quality replacement to reduce engine noise outside of the vehicle while protecting the hood from high engine temperatures. Clips sold separately. Made in USA.

Note: *Includes clips.

MA340	1967-76	Dart, 70-76 Duster, 67-69 Cuda	26.99 ea
MB392*	1966-67	B-Body Charger, Coronet, Road Runner	24.99 ea
MB393	1968-69	B-Body Charger, Coronet, Road Runner	24.99 ea
MB394*	1970	B-Body Charger, Coronet, Road Runner	24.99 ea
MD341	1971-74	B-Body all	24.99 ea
MD341	1970-74	E-Body all	24.99 ea

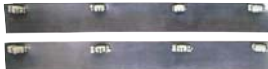

Early 1969 B-Body N96 Vent Seal Set



Vent seals that mount on each side of the N96 fresh air hood plenum ductwork. These seals allow water and other contaminants to flow out of the ductwork while also preventing hot engine compartment air from being sucked back in. Often painted-over or missing, these early 1969 style seals are rectangular in shape and will fit the early style plenum that has 3 large rectangular shaped openings on each side. Made in USA.

MB335 1969 2 piece set with clips..... 29.99 set

Late 1969 B-Body N96 Vent Seal Set



Vent seals that mount on each side of the N96 fresh air hood plenum ductwork. These seals allow water and other contaminants to flow out of the ductwork while preventing hot engine compartment air from being sucked back in. Often painted-over or missing, these late 1969 style seals are polygonal in shape and will fit the late style plenum which has 2 square openings on each side. Made in USA.

MB336 1969..... 29.99 set

1964-68 Velocity Stack Seals

Velocity stack seals for 1964-65 B-Body Mopar models with Hemi engines, including 1964-65 Max Wedge models. Also fits 1968 Hemi S/S A-Body models. These seals mount between the hood and the velocity stacks. Produced in rubber as original. Made in USA.



MD2112 1964-68..... 129.99 pr



1970 Trap Door Seals

Replacement of the rubber hood "trap door" seals for 1970 GTX and Road Runner models. Manufactured to OE specifications for an authentic fit, appearance, and function. Made in USA.

MB2221 1970..... 14.99 pr



MD342



MD2105



MD2104

1964-76 Hood Insulation Clips

Replacement hood insulation clips for various 1964-76 models.

MD2104	1964-72	black plastic	1.99 ea
MD2105	1972-76	1-1/2" L x 1/2" W with 5/8" prong, nylon	1.99 ea
MD342	1972-76	22 piece set	14.99 set

Hood Components



MM1841

1967 Coronet R/T Hood Louver Moldings

Hood louver moldings for 1967 Coronet R/T models. These moldings mount on the four louvers in the rear center of the hood. Four required per vehicle.

MM1840	1967	individual molding.....	44.99 ea
MM1841	1967	set of four.....	169.99 set



MA2229



MA2230

1968-69 Dart GTS Hood Inserts

Replacement hood insert sets for 1968-69 Dart GTS models. Features correct contours, chrome plating and include mounting gaskets. Mounting gaskets are also available separately.

Important: Engine call outs are not included.

MA2229	1968	hood inserts.....	344.99 set
MA2230	1969	hood inserts.....	344.99 set
MA2472	1968-69	mounting gaskets.....	14.99 pr



MB1253



MB306



MB307

1968 GTX, Road Runner Engine Call-outs

Manufactured in bright aluminum and accented in flat black just like the originals, these inserts tell the world what lies beneath the hood of your classic muscle car. Available in your choice of three styles including "383" for standard engine equipped Road Runners, "440" for standard engine equipped GTX models or "Hemi" for those of you lucky enough to have a Hemi-equipped GTX or Road Runner.

MB1253	1968	"383" Road Runner.....	184.99 set
MB306	1968	"440" GTX.....	184.99 set
MB307	1968	"HEMI" GTX, Road Runner.....	184.99 set



MM1447



MB1726

1969 GTX/Road Runner Hood Insert Set

Reproduction hood insert set for 1969 GTX and Road Runner models. These inserts feature a die cast base, ribbed top and include gaskets and mounting nuts. Mounting gaskets are also sold separately.

MM1447	1969	hood insert set.....	224.99 set
MB1726	1969	mounting gaskets.....	17.99 pr



1968-69 Power Budge Hood Insert Gaskets

Die cut from original style and thickness black plastic. These gaskets prevent paint chipping when hood inserts are installed and will fit 1968-69 Coronet Super Bee and R/T models. Made in USA.

MB1727	1968-69	17.99 pr
--------	---------	-------	----------



MM1446

1970 GTX/Road Runner Hood Insert

Reproduction hood insert for 1970 GTX and Road Runner models. Features correct emblem mounting holes and is available with or without turn signal lamp provisions.

This insert is mounted on the rear of the hood.

Note: Engine specification emblem and turn signal lamps are not included.

MM1445	1970	w/o provision for turn signal lamps.....	149.99 ea
MM1446	1970	with provision for turn signal lamps.....	149.99 ea



MM1448B



MM1448A underside



MM1448B underside



MM1448A underside



1970-74 Challenger R/T Hood Inserts

Factory-style replacement R/T Hood Inserts for 1970-74 Challenger R/T and Rallye models equipped with R/T hood. Your choice of our Restorer's Choice insert, officially licensed by Mopar, manufactured to original specifications and featuring all original contours and details or our standard replacement for the car builder on a budget. Sold as a pair.

MM1448B	1970-74	Restorer's Choice	179.99 pr
MM1448A	1970-74	standard replacement.....	149.99 pr

Hood Scoop Components



1970-71 Shaker Hood Trim Ring

Trim ring for 1970-71 E-Body shaker hoods. Manufactured from cast metal this trim ring features cast studs as original, and includes mounting nuts.

ME1662	1970-71	Barracuda.....	204.99 ea
ME5061	1970-71	Challenger.....	204.99 ea

New!



1967 GTX Hood Scoops

Reproduction hood scoops for 1967 GTX models. Manufactured to factory specifications, these hood scoops feature correct material, threaded studs, authentic markings, and are ready to prep and paint. Includes bezels and hardware.

MP41100	1967.....	399.99 set
---------	-----------	------------

AUTHENTIC RESTORATION



1967 GTX Hood Scoop Bezels

Reproduction hood scoop bezels for 1967 GTX models. Feature correct chrome plating, black accents and contours. Includes mounting hardware. Made in USA.

MM1834	1967	LH.....	99.99 ea
MM1835	1967	RH.....	99.99 ea
MM1837	1967	LH/RH.....	184.99 pr

New!



1967 GTX Hood Scoop Mounting Hardware

Reproduction hood scoop mounting hardware set for 1967 GTX models. Every set includes the correct studs, bell tower nuts, and sealing washers. One set required per vehicle.

MN3068	1967.....	65.99 set
--------	-----------	-----------

New!

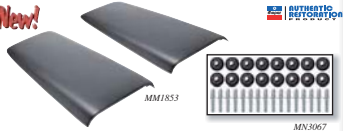

1969-72 A & B-Body Twin Hood Scoops

Reproduction twin hood scoops for various 1969-72 A-Body and B-Body vehicles. Manufactured to factory specifications, these scoops feature correct material, threaded studs, authentic markings and are ready to prep and paint. Fits 1970 Dart, 1971-72 Demon/Duster, 1969-70 Coronet, Super Bee and R/T models. Mounting hardware is included, and also available separately.

MM1853	1969-72	hood scoops.....	284.99 pr
MN3067	1969-72	mounting hardware.....	79.99 set

Made in USA



1969-70 A & B-Body Chrome Twin Hood Scoop Trim Bezels

Quality zinc die cast bezels, correctly chrome plated with argent and flat black accents for the Mopar twin hood scoops as originally installed for the following 1969-72 A & B-Body cars: 1970 Swinger 340, 1970 Duster Twister & 340 and 1969-70 Coronet R/T & Super Bee with fresh air hoods. Made in USA.

Important: Most 1971-72 Duster Twisters & 340s and Demon Sizzlers & 340s with the black out hood treatment used black bezels but these will fit if the chrome finish is preferred.

Note: Mounting hardware is included.

MM1828	1969-70	LH.....	64.99 ea
MM1829	1969-70	RH.....	64.99 ea
MM1830	1969-70	LH/RH.....	119.99 pr

Made in USA



1971-72 A & B-Body Black Twin Hood Scoop Trim Bezels

Quality zinc die cast bezels, powder coated flat black for the Mopar twin hood scoops as originally installed on the following A-Body models: 1971-72 Duster Twister, Duster 340, Demon Sizzler and Demon 340 models with the black out hood treatment. Made in USA.

Important: The 1970 Swinger 340, 1970 Duster Twister & 340 and 1969-70 Coronet R/T & Super Bee with fresh air hoods generally used chrome bezels but these will fit if the black finish is preferred.

Note: Mounting hardware is included.

MM1831	1971-72	LH.....	56.99 ea
MM1832	1971-72	RH.....	56.99 ea
MM1833	1971-72	LH/RH.....	109.99 pr

AUTHENTIC RESTORATION



1969-74 A56/A57/A13/A51 Hood Scoops

Reproduction hood scoops for 1969 Cuda models with the A56-340, A57-383 or A13-440 option and 1973-74 Duster models with A51 Twister package. Manufactured from cast metal, featuring correct contours. Includes mounting gaskets.

MA3469	1969-74.....	394.99 pr
--------	--------------	-----------

Mopar Hood Scoops



1970-72 Dodge Dart Dual Snorkel Hood Scoop - Fiberglass

Reproduction hood scoop for 1970-72 Dodge Dart models. This is a dual snorkel style hood scoop made to fit the Dart hood. Manufactured out of fiberglass and designed to bolt on like original. Includes mounting hardware.

MA2445 1970-72 Dart 349.99 ea



1970-76 Plymouth Duster Dual Snorkel Hood Scoop - Fiberglass

Reproduction hood scoop for 1970-76 Plymouth Duster models. This is a dual snorkel style hood scoop made to fit the Duster hood. Manufactured out of fiberglass and designed to bolt on like original, this is a stock Ram Air on the underside. Includes mounting hardware.

MA2447 1970-76 Duster 399.99 ea



Dodge Six Pack Hood Scoop - Fiberglass

Universal replacement of the Dodge "Six Pack" hood scoop originally for Dodge models with the 3 x 2 carburetor setup. Manufactured from fiberglass, this is a universal fit scoop that can be installed on any flat hood for this desired look. Designed to be glued (epoxy) to the hood.

MA2448 Dodge "Six Pack" Hood Scoop 189.99 ea



Universal Dual Snorkel Hood Scoop - Fiberglass

Universal dual snorkel hood scoop for various Mopar models. Manufactured from fiberglass, this is a universal fit scoop that is open on the underside and can be installed on any flat hood for this desired look. Designed to be glued (epoxy) to the hood.

MA2449 universal dual snorkel 289.99 ea



Mopar Super Six Pack Hood Scoop - ABS Plastic

Reproduction of the "Six Pack" hood scoop originally for Dodge models with the 3 x 2 carburetor setup. Manufactured from ABS plastic, this is a universal fit scoop that can be installed on any flat hood for this desired look. This scoop is open in the front. Attaches with strong 3M adhesive tape (included).

Measures 28" L x 31" W x 4.5" H.
MA2450 Super Six-Pack 109.99 pr



Mopar Pro Stock Mini Hood Scoop - ABS Plastic

Reproduction of the Mopar Pro Stock Mini hood scoop for Mopar models. Manufactured from ABS plastic, this is a universal fit scoop that can be installed on any flat hood for this desired look. Attaches with strong 3M adhesive tape (included).

Measures 28.5" L x 19.5" W x 3.5" H.
MA2451 Pro Stock Mini 84.99 ea



Mopar Pro Stock "Snorkel" Hood Scoop - ABS Plastic

Reproduction of the Mopar Pro Stock Snorkel hood scoop originally for various Mopar models. Manufactured from ABS plastic, this is a universal fit scoop that can be installed on any flat hood for this desired look. Attaches with rivets or bolts (not included). Measures 29" L x 16.5" W x 5" H.

MA2452 Pro Stock Snorkel 115.99 ea



Mopar Super Six Pack Hood Scoop - Fiberglass

Reproduction of the Dodge "Super Six Pack" hood scoop originally for Dodge models with the 3 x 2 carburetor setup. Manufactured from fiberglass, this is a universal fit scoop that can be installed on any flat hood for this desired look. Attaches with rivets or bolt, (not included).

Measures 28" L x 31.5" W x 3.5" H
MA2453 Super Six-Pack 144.99 ea

HARWOOD Fiberglass Hood Scoops



HA3160



HA3164



HA3180



HA4162



HA3161



HA3165



HA3181



HA4163



HA3162



HA3166



HA3182



HA4164



HA3163



HA3168



HA3183



HA4166



HA1996



HA1998



HA1999



HA2000



HA2001

Harwood Fiberglass Aero Hood Scoops

These hood scoops are designed to provide maximum air flow and a lightweight advantage while providing a look that will fit in with the sleekest of all-out performance machines.

Available in a flanged style that can be bonded or riveted on, and also a limited selection of bolt-on styles. A selection of scoop plugs are also available.

Note: Shipped oversize. No further discounts apply.



Part #	Type	Style	Length	Width	Height	OAL	Notes	Use Plug #	Price	
HA3160	Aero I	flange	36"	x 17.5"	x 12"	40.5"	closed back	HA2000	239.99 ea	
HA3161	Aero Pro I	flange	36"	x 17"	x 11"	48"	open back	HA2000	261.99 ea	
HA3162	Aero Mini I	flange	30"	x 14.5"	x 9"	32"	closed back	HA2001	239.99 ea	
HA3163	Aero Mini II	flange	30"	x 15"	x 7"	31.5"	closed back	HA2001	261.99 ea	
HA3164	Aero II	flange	29"	x 17"	x 9.5"	35"	closed back	HA2000	261.99 ea	
HA3165	Aero Mod I	flange	43"	x 17.5"	x 8.5"	48"	closed back	HA2000	261.99 ea	
HA3166	Aero III	flange	29"	x 17"	x 7.5"	35"	closed back	HA2000	261.99 ea	
HA3168	Aero Pro III	flange	37"	x 20"	x 11"	48"	open back	HA1999	261.99 ea	
HA3180	Aero Pro Stock IV	flange	38.5"	x 16"	x 11.75"	50"	open back	HA1998	304.99 ea	
HA3181	Aero Pro Mod	flange	38"	x 20"	x 13"	53.75"	open back	n/a	289.99 ea	
HA3182	Tri Aero	flange	40"	x 14"	x 13"	51"	open back	HA1996	315.99 ea	
HA3183	Tri Aero Mini	flange	30"	x 14"	x 11"	33.5"	closed back	HA1996	314.99 ea	
HA4162	Aero Mini I	bolt-on	30"	x 14.5"	x 9"	32"	incl gskt & hdwr	HA2001	314.99 ea	
HA4163	Aero Mini II	bolt-on	30"	x 15"	x 7"	31.5"	incl gskt & hdwr	HA2001	314.99 ea	
HA4164	Aero II	bolt-on	29"	x 17"	x 9.5"	35"	incl gskt & hdwr	HA2000	314.99 ea	
HA4166	Aero III	bolt-on	29"	x 17"	x 7.5"	35"	incl gskt & hdwr	HA2000	314.99 ea	
HA1996	scoop plug	use with HA3182, HA3183								31.99 ea
HA1998	scoop plug	use with HA3180								27.99 ea
HA1999	scoop plug	use with HA3168								29.99 ea
HA2000	scoop plug	use with HA3160, HA3161, HA3164, HA3165, HA3166, HA4164, HA4166								29.99 ea
HA2001	scoop plug	use with HA3162, HA3163, HA4162, HA4163								27.99 ea

Fresh Air Components



1969-70 B-Body N96 Fresh Air Duct Assembly

Replace the duct assembly on 1969-70 B-Body vehicles equipped with the N96 fresh air hood option. Commonly referred to as the "Ram Charger" hood on 1969-70 Coronet, Super Bee models or the "Air Grabber" hood on 1969 GTX and Road Runner models, these hoods were optional on all models with a single four-barrel and standard on 426 HEMI equipped cars. Each includes the correct heavy duty fiberglass duct assembly for your particular model, mounting rivets, under-hood cable, clips, vent seals and decals. Applications are available for all models equipped with N96 fresh air hood option.

1969-70 Coronet, Super Bee - Ram Charger

MB344	1969	with black ductwork.....	604.99 ea
MB345	1970	with red ductwork.....	604.99 ea
1969 GTX, Road Runner - Air Grabber			
MB346	1969	with black ductwork.....	604.99 ea

1969-72 Fresh Air Duct Mounting Hardware

Reproduction mounting hardware set for the fresh air duct assembly on 1969-70 GTX, Road Runner and 1970-72 Coronet, and Super Bee models. Includes all the necessary hardware to replace the fresh air duct assembly.



MN2887	1969	Plymouth.....	41.99 set
MN2888	1970	Plymouth.....	46.99 set
MN2887	1969-70	Dodge.....	41.99 set
MN2888	1971-72	Dodge.....	46.99 set



1969 Air Grabber Hood Insert Set

Replacement insert set for 1969 Plymouth models with the Air Grabber option. This set installs on the hood bezels to make the hood intake functional. Mounting hardware is included.

MB1909	1969	104.99 set
--------	------	-------	------------



1970-71 E-Body Shaker Hood Components

The "Shaker" bubble-to-base fastener set includes 7 correct anchor head 10-24 screws for mounting the bubble to the steel base plate. The drain hose set includes two hoses of correct material, length and diameter and period correct hose clamps. The hoses attach to the base plate to allow water to drain properly. The ground straps are two copper straps that mount under the hood to properly ground the unit.

ME1324	1970-71	bubble fastener set.....	25.99 set
ME1325	1970-71	drain hose set.....	34.99 set
ME1326	1970-71	ground straps.....	24.99 pr

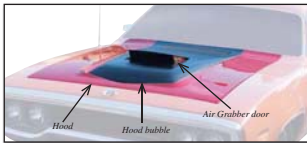

1971-72 Air Grabber Hood/Bubble Door

Reproduction of the Air Grabber Center hood, hood bubble and the Air Grabber door for 1971-72 Plymouth Road Runner models. Manufactured from fiberglass, in the correct size and shape as original, this hood has all the mounting plates installed for the hinges and latch in the stock mounting locations. The long center hood bubble and door are also made of fiberglass and will give your car that cool factory look. The Air Grabber door can be used to replace a functional door or add on for the Air Grabber look.

Important: The hole for the hood bubble is not pre-cut in the hood from the factory and must be cut by the customer if desired. Bubble to be glued (epoxy) to the hood.

Note: *Shipped track freight **Shipped overseas.		
MB1693*	1971-72 Air Grabber hood.....	899.99 ea
MB1692**	1971-72 bubble and door.....	549.99 ea



ME1538



ME1538 detail

1969-71 Under-Dash Fresh Air Cable

Under-dash cables for 1969-70 B-Body and 1970-71 E-Body models. Replace your broken or missing cable. Feature correct style knob, cable, "Carb Air" foil decal and includes the firewall grommet.

B-Body		
MB2030	1969-70.....	74.99 ea
E-Body		
ME1538	1970-71.....	74.99 ea

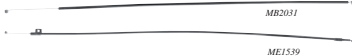

1969-71 Under-Hood Fresh Air Cable

Under-hood fresh air cable for 1969-70 B-Body and 1970-71 E-Body models. This cable mounts underneath the hood and is used to actuate the air flaps.

B-Body		
MB2031	1969-70.....	15.99 ea
E-Body		
ME1539	1970-71.....	29.99 ea

1969-71 B & E-Body Air Knob Applique

Replace your damaged decal with a quality replacement for 1969-70 B-Body models and 1970-71 E-Body models. This foil decal features the "Carb Air" words and is backed with 3M adhesive.

MB2032	1969-70	fresh air hood.....	9.99 ea
MB2032	1970-71	shaker hood.....	9.99 ea



1970 Air Grabber Switch Bezel

Air Grabber switch bezel for 1970 Mopar B-Body applications. This is the bezel into which the "air grabber" switch is mounted under the dash. Manufactured in black plastic with white lettering.

MN1612	1970.....	12.99 ea
--------	-----------	----------



Fresh Air Components



1970-72 B-Body N96 Switch Components

Commonly referred to as the "Ram Charger" hood on 1971-72 Charger and 1971 Super Bee or the "Air Grabber" hood on 1970-71 GTX and 1970-72 Road Runner, these hoods utilized a trap door that popped open to force air into the fresh air ductwork. These components are exact replacements of the originals and will perfectly replace your inoperative or missing pieces to get your fresh air door operating properly once again.

Solenoid			
MB489	1970-72	OE style.....	184.99 ea
Solenoid Bracket			
MB490	1971-72	14.99 ea
Switches			
MB340	1970	red knob.....	119.99 ea
MB341	1971-72	black knob.....	144.99 ea
Switch Bracket			
MB342	1971-72	184.99 ea



1970-72 B-Body N96 Vacuum Components

With our convenient sets, you can repair your system with authentic looking hoses and components for complete originality. Hose sets include correctly grooved and color-coded hoses, molded switch plug, firewall fittings, and 6 retainer clips. The retainer clips are the correct color and manufactured from original tooling. Clip sets are also available separately as a 6 piece set in case you do not need to replace your vacuum hose. Switch is sold separately.

Vacuum Reservoir Canister			
MB330	1970-72	99.99 ea
Vacuum Hose Sets			
MB331	1970	109.99 set
MB332	1971-72	109.99 set
Retainer Clip Sets			
MB333	1970-72	29.99 set



1969-72 B-Body N96 Air Cleaner to Box Seal

Rubber seal that seals area between air duct and air cleaner on 1969-72 B-Body models with N96 hoods. Oval shape matches original air duct and air cleaner base shape for an airtight seal.

MN1010	1969-72	Restorator's Choice.....	119.99 ea
MB334	1969-72	standard replacement.....	84.99 ea



1970-72 B-Body N96 Trap Door Components

Commonly referred to as the "Ram Charger" hood on 1971-72 Charger and 1971 Super Bee or the "Air Grabber" hood on 1970-71 GTX and 1970-72 Road Runner, these hoods utilized a trap door that popped open to force air into the fresh air ductwork.

Charger, Super Bee			
MB338	1971-72	trap door.....	174.99 ea
MB348	1971-72	door pins w/circlips..	39.99 pr
GTX, Road Runner			
MB338	1970	trap door.....	174.99 ea
MB339	1971-72	trap door.....	134.99 ea
MB348	1970-72	door pins w/circlips..	39.99 pr



1971-72 Air Grabber Door Hinge

Replacement air grabber door hinge for 1971-72 Plymouth models equipped with an air grabber hood. This hinge is welded to the underside of the hood.

MB1908	1971-72	41.99 ea
--------	---------	-------	----------



1970-72 B-Body Air Grabber Hose Clips

Reproduction air grabber hose clips for 1970-72 Road Runner, 1971-72 Charger and Super Bee models. Manufactured in the correct size and color for an authentic appearance.

MN2118	1970-72	6 piece set.....	21.99 set
--------	---------	------------------	-----------



1970-72 N96 Air Cleaner Lid

Commonly referred to as the "Ram Charger" hood on 1971-72 Charger and 1971 Super Bee, the "Air Grabber" hood on 1970-71 GTX and 1970-72 Road Runner, or the "Shaker Hood" on 1970-71 Barracuda, "Cuda and Challenger models, the B-Body and E-Body vehicles with the N96 fresh air hood option all shared an identical air cleaner lid. This air cleaner lid is manufactured in steel and painted the original factory orange.

MF234	1970-72	84.99 ea
-------	---------	-------	----------



1970-72 B-Body N96 Fresh Air Box Duct

Commonly referred to as the "Ram Charger" hood on 1971-72 Charger, 1971 Super Bee or the "Air Grabber" hood on 1970-71 GTX and 1970-72 Road Runner, these hoods utilized a large duct commonly referred to as an "air box" that bolted beneath the underside of the hood to route the air into the air cleaner assembly. This duct is injection molded just like the original.

MB337	1970-72	294.99 ea
-------	---------	-------	-----------



1970-72 B-Body N96 Hood Opening Frame

This metal frame can be welded to a non-N96 hood to convert it to a fresh air hood or can be used to repair the opening on a factory N96 hood. Fits 1970 GTX and Road Runner as well as 1971-72 Charger and Super Bee.

MB343	1970-72	264.99 ea
-------	---------	-------	-----------



1970-72 B-Body N96 Lower Door Components

The N96 hood utilized a large duct commonly referred to as an "air box" that bolted beneath the underside of the hood to route the air into the air cleaner assembly. At the front of this duct was the lower door, commonly referred to as the "flapper" which opened and closed by the way of a vacuum controlled actuator. These components will replace your originals to get your fresh air system operating properly again. Door Assembly includes flapper door, shaft, door spring, end caps, and all linkage and clips. Vacuum actuator hardware not included with assembly.

Hood Studs			
MB349	1970-72	4.99 ea
Lower Air Flapper Door			
MB350	1970-72	69.99 ea
Lower Air Flapper Door Assembly			
MB351	1970-72	with end caps.....	184.99 ea
Lower Air Flapper Door End cap			
MB352	1970-72	31.99 ea
Lower Air Flapper Door Spring			
MB353	1970-72	39.99 ea
Vacuum Actuator			
MB354	1970-72	189.99 ea
Vacuum Actuator Bracket			
MB355	1970-72	54.99 ea
Vacuum Actuator Assist Spring			
MB356	1970-72	19.99 ea

Fenders & Parts

New!



MA822030
detail



MM1851A
detail



MA822030



MM1851A

RESTORER'S
CHOICE™

1968-74 Front Fenders

Factory-style front fenders for 1968-74 A, B and E-Body models. Your choice of our Restorer's Choice panel, officially licensed by Mopar, manufactured in OE-gauge steel featuring all original contours and details or our standard replacement for the car builder on a budget. Fenders come finished in semi-flat black EDP coating to prevent rust and are ready to prep and paint to your desired color.

Note: Shipped truck freight.

Restorer's Choice

Part No.	Year	Model	Material	Price
MA822035	1968	LH Dart	479.99 ea
MA822036	1968	RH Dart	479.99 ea
MA822032	1969	LH Dart	479.99 ea
MA822033	1969	RH Dart	479.99 ea
MA822030	1970-71	LH Dart	479.99 ea
MA822031	1970-71	RH Dart	479.99 ea
MA822030	1971	LH Demon	479.99 ea
MA822031	1971	RH Demon	479.99 ea
MA822038	1970-71	LH Duster	479.99 ea
MA822039	1970-71	RH Duster	479.99 ea
MA822038	1971	LH Scamp	479.99 ea
MA822039	1971	RH Scamp	479.99 ea
MA822040	1972	LH Duster/Scamp	479.99 ea
MA822041	1972	RH Duster/Scamp	479.99 ea
MA822042	1973-74	LH Duster/Scamp	479.99 ea
MA822043	1973-74	RH Duster/Scamp	479.99 ea

B-Body				
MM1091	1968	LH Charger	699.99 ea
MM1092	1968	RH Charger	699.99 ea
MM1093	1969	LH Charger	699.99 ea
MM1094	1969	RH Charger	699.99 ea
MM1095	1968	LH Plymouth B-Body	699.99 ea
MM1096	1968	RH Plymouth B-Body	699.99 ea
MM1097	1969	LH Plymouth B-Body	699.99 ea
MM1098	1969	RH Plymouth B-Body	699.99 ea

E-Body				
MM2327B	1970-71	LH Challenger	614.99 ea
MM2328B	1970-71	RH Challenger	614.99 ea
MM1130B	1972-74	LH Challenger	614.99 ea
MM1131B	1972-74	RH Challenger	614.99 ea
MM1845B	1970	LH Barracuda	614.99 ea
MM1846B	1970	RH Barracuda	614.99 ea
MM1849B	1971	LH Barracuda with gills	609.99 ea
MM1850B	1971	RH Barracuda with gills	609.99 ea
MM1851B	1972-74	LH Barracuda	614.99 ea
MM1852B	1972-74	RH Barracuda	614.99 ea

Standard Replacement

E-Body				
MM2327A	1970-71	LH Challenger	399.99 ea
MM2328A	1970-71	RH Challenger	399.99 ea
MM1130A	1972-74	LH Challenger	399.99 ea
MM1131A	1972-74	RH Challenger	399.99 ea
MM1845A	1970	LH Barracuda	489.99 ea
MM1846A	1970	RH Barracuda	489.99 ea
MM1847A	1971	LH Barracuda without gills	489.99 ea
MM1848A	1971	RH Barracuda without gills	489.99 ea
MM1849A	1971	LH Barracuda with gills	489.99 ea
MM1850A	1971	RH Barracuda with gills	489.99 ea
MM1851A	1972-74	LH Barracuda	489.99 ea
MM1852A	1972-74	RH Barracuda	489.99 ea

New!



1962-67 Fender Bolt Sets

Reproduction fender bolt sets for various 1962-67 models. Manufactured to look and fit just like the originals. One set required per vehicle.

MN2106	1963-66	A-Body	39.99 set
MN2893	1967-70	A-Body	79.99 set
MN2107	1962-63	B-Body	43.99 set
MN2108	1964-65	B-Body	43.99 set
MN2109	1966-67	B-Body	48.99 set
MN2894	1968-69	B-Body	89.99 set
MN2895	1970	B-Body	99.99 set
MN2896	1970	AAR Cuda	84.99 set
MN2897	1970-74	E-Body - except AAR Cuda	74.99 set



1971 Barracuda Headlamp Brackets

Replacement headlamp brackets for 1971 Barracuda and 'Cuda models. These brackets mount to the headlamp back plate and are the mounting point for the headlamp brackets. Mounting feet are included. Sold as a pair.

ME8131	1971	259.99 pr
--------	------	-------	-----------



1971 Barracuda Headlamp Back Plates

Replacement headlamp back plates for 1971 Barracuda models. These plates are welded to the inner side of the fender and are the mounting point for the headlamp brackets.

ME8132	1971	199.99 pr
--------	------	-------	-----------

New!



1963-76 Fender Lower Rear Patch Panels

Replacement fender lower rear patch panels for various 1967-76 models. Each panel features correct gauge sheet metal, correct lower, front and rear profile. All panels include the lower portion of the rear fender brace.

A-Body				
MP41239	1963-66	LH Barracuda/Volant	85.99 ea
MP41240	1963-66	RH Barracuda/Volant	85.99 ea
MP41241	1963-65	LH Dart/Swinger	85.99 ea
MP41242	1963-65	RH Dart/Swinger	85.99 ea
MP41243	1966	LH Dart/Swinger	89.99 ea
MP41244	1966	RH Dart/Swinger	89.99 ea
MM1973	1967-76	LH Dart	109.99 ea
MM1974	1967-76	RH Dart	109.99 ea
MM1973	1973-76	LH Dart Sport	109.99 ea
MM1974	1973-76	RH Dart Sport	109.99 ea
MM1973	1971-72	LH Demon	109.99 ea
MM1974	1971-72	RH Demon	109.99 ea
MM1975	1970-76	LH Duster	109.99 ea
MM1976	1970-76	RH Duster	109.99 ea

B-Body				
MM8332	1968-69	LH Charger	129.99 ea
MM8333	1968-69	RH Charger	129.99 ea
MM1977	1971-72	LH Road Runner	129.99 ea
MM1978	1971-72	RH Road Runner	129.99 ea

E-Body				
MM8334	1970-74	LH Barracuda	129.99 ea
MM8335	1970-74	RH Barracuda	129.99 ea

88 BODY COMPONENTS

Fender & Inner Fender



1972-74 Challenger Fender Scoop Insert

Reproduction fender scoop insert for 1972-74 Challenger Rallye models. Manufactured in injection molded ABS plastic with correct detail and mounts behind the metal scoop as original.

ME861005 1972-74..... 85.99 pr



1971 'Cuda Fender Gill Patch Panels

Replacement fender gill patch panels for 1971 'Cuda models. These panels will allow you to install any original or reproduction style fender ornaments without having to replace the entire fender. Sold as a pair.

ME1830 1971..... 104.99 pr



1968-74 Inner Fenders

Factory-style replacement inner fender for various 1966-74 models. One of the most critical and important sheet metal panels is the front fender skirt or inner fender. These panels provide critical support for the fenders and keep water and other road hazards out of the engine bay. Because of the location of these panels, they take abuse from the road like rocks, salt and other hazards and often rust out as a result. Each panel is stamped to original factory specifications. Your choice of our Restorer's Choice panel, officially licensed by Mopar, manufactured in OE-gauge steel featuring all original contours and details or our standard replacement for the car builder on a budget. Comes finished in black EDP coating to prevent rust and ready to prep and paint to your desired color.

Note: Shipped double oversize.

Restorer's Choice

A-Body			
MM1031	1967-74	LH.....	204.99 ea
MM1032	1967-74	RH.....	204.99 ea
MM1033	1967-74	LH/RH.....	394.99 pr
B-Body			
MM1034B	1966-70	LH.....	204.99 ea
MM1035B	1966-70	RH.....	204.99 ea
MM1036	1966-70	LH/RH.....	389.99 pr
MM1037B	1971	LH.....	204.99 ea
MM1038B	1971	RH.....	204.99 ea
MM1039	1972	LH.....	204.99 ea
MM1040	1972	RH.....	204.99 ea
E-Body			
MM1037B	1970-71	LH.....	204.99 ea
MM1038B	1970-71	RH.....	204.99 ea
MM1039	1972-74	LH.....	204.99 ea
MM1040	1972-74	RH.....	204.99 ea

Standard Replacement

MM1034A	1966-70	LH.....	164.99 ea
MM1035A	1966-70	RH.....	164.99 ea
MM1037A	1971	LH.....	164.99 ea
MM1038A	1971	RH.....	164.99 ea
E-Body			
MM1037A	1970-71	LH.....	164.99 ea
MM1038A	1970-71	RH.....	164.99 ea

New!



1970-74 Challenger Fender Apron Assembly

Reproduction fender apron assembly for 1970-74 Challenger models. Manufactured to factory specifications featuring correct gauge sheet metal, pre-drilled holes where necessary and EDP coating for rust prevention.

Note: Shipped truck freight.

ME175929 1970-74 LH..... 774.99 ea
 ME175930 1970-74 RH..... 774.99 ea



1970-74 E-Body Inner Fender Apron Set

Replacement inner fender apron sets for 1970-74 E-Body models. These sets are manufactured to repair many commonly rusted items that require removal when the inner fender apron is being replaced. All items included feature EDP coating for rust prevention.

Note: Shipped double oversize.

ME861030 1970-74 LH 12 piece set..... 229.99 set
 ME861031 1970-74 RH 12 piece set..... 229.99 set

New!



1967-74 A & B-Body Fender Braces

Reproduction steel fender braces for various 1967-74 A and B-Body models. Manufactured to original factory specifications for proper fit and appearance. Sold individually, 2 required per car. Made in USA!

MM1139 1967-74 A-Body..... 24.99 ea
 MM1139 1966-67 B-Body exc. Charger..... 24.99 ea
 MM1138 1968-69 B-Body exc. Charger..... 24.99 ea



1970-74 E-Body Inner Fender Patch Panel

Replacement inner fender patch panel for all 1970-74 E-Body models. This piece will repair the upper rear section of the inner fender on Barracuda and Challenger models.

MM8268 1970-74 LH..... 99.99 ea
 MM8267 1970-74 RH..... 99.99 ea



1982-74 Front Inner Fender Plates

Front inner fender cover panel for various 1962-74 models. This panel mounts inside the front lower portion of the fender. Manufactured in OE-gauge steel featuring all original contours and details. Comes finished in black EDP coating to prevent rust and ready to prep and paint to your desired color.

MM3183 1962-65 B-Body..... 29.99 pr
 MM1045B 1966-70 B-Body..... 24.99 pr
 MM1046B 1971-72 B-Body..... 24.99 pr
 MM1046B 1970-74 E-Body..... 24.99 pr

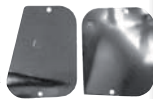

Fender Brackets



1966-74 B and E-Body Inner Fender Brackets

Factory-style replacement inner fender to cowl brackets for various 1966-74 Mopar models. These brackets mount at the top and lower portion of the inner fender where it meets the cowl panel. Your choice of our Restorer's Choice panel, officially licensed by Mopar, manufactured in OE-gauge steel featuring all original contours and details or our standard replacement for the car builder on a budget. Comes finished in black EDP coating to prevent rust and ready to prep and paint to your desired color.

Restorer's Choice

B-Body	
Upper Brackets	
MM1583B 1966-70 LH	49.99 ea
MM1584B 1966-70 RH	49.99 ea
MM1585 1966-70 LH/RH	79.99 pr
Lower Brackets	
MM1586 1966-70 LH	51.99 ea
MM1587 1966-70 RH	51.99 ea

E-Body	
Upper Brackets	
MM1588 1970-74 LH	39.99 ea
MM1589 1970-74 RH	39.99 ea
MM1590 1970-74 LH/RH	69.99 pr
Lower Brackets	
MM1591B 1970-74 LH	49.99 ea
MM1592B 1970-74 RH	49.99 ea
MM1593 1970-74 LH/RH	79.99 pr
Upper Bracket to Cowl	
MM1594 1970-74 LH/RH	39.99 pr

Standard Replacement

B-Body	
Upper Brackets	
MM1583A 1966-70 LH	39.99 ea
MM1584A 1966-70 RH	39.99 ea
E-Body	
Lower Brackets	
MM1591A 1970-74 LH	39.99 ea
MM1592A 1970-74 RH	39.99 ea



1970-74 E-Body Fender To Cowl Bracket

Factory-style replacement fender to cowl bracket for 1970-74 E-Body models. Often rusted out, this bracket provides additional support to the fender by attaching it to the cowl panel. Your choice of our Restorer's Choice bracket, officially licensed by Mopar, manufactured in OE-gauge steel featuring all original contours and details or our standard replacement for the car builder on a budget.

Restorer's Choice

MM1109B 1970-74 LH/RH	34.99 pr
-----------------------	----------

Standard Replacement

MM1107A 1970-74 LH	9.99 ea
MM1108A 1970-74 RH	9.99 ea

1967-76 Inner Fender to Cowl Braces

New! New steel replacement inner fender to cowl braces for 1967-76 models. This metal reinforcement is welded in place between the inner fenders and the cowl panel, which is hidden by the fenders when they are installed. Each brace is EDP coated and is designed to replace the original exactly.

A-Body	
MA688010 1967-76 LH	79.99 ea
MA688011 1967-76 RH	79.99 ea
B-Body	
MM8316 1971-72 LH	59.99 ea
MM8317 1971-72 RH	59.99 ea
E-Body	
MM8316 1970-74 LH	59.99 ea
MM8317 1970-74 RH	59.99 ea



1962-70 B-Body Splash Shields

Splash shields for 1962-65 and 1968-70 B-Body models. These splash shields protect the engine bay and front fenders from dirt, water, and rock damage. Produced in rubber, these shields will fit, function and appear as original.

Strut Splash Shield	
MB2217 1962-65 strut splash shield	9.99 pr
Front Fender Inner Splash Shield	
MB2218 1962-65 top front	31.99 pr
MB2219 1962-65 top rear	14.99 pr
Inner Fender to Firewall Seals	
MB2220 1968-70 top front	25.99 pr



Reproduction fender rear splash shields for various 1963-76 models. Your choice of Restorer's Choice splash shields, officially licensed by Mopar, manufactured in original material featuring all original contours and details or standard replacements for the car builder on a budget. These shields install between the fender and the cowl area and prevent debris from entering the door hinge area.

Note: *Manufactured in plastic as original.

Restorer's Choice

A-Body	
MM1898 1970-76 all	179.99 pr
B-Body	
MM1933 1963 all	179.99 pr
MM3181 1964 Dodge	219.99 pr
MM3182 1964 Plymouth	219.99 pr
MM3180 1965 all	219.99 pr
MM1044B 1968-70 Dodge	189.99 pr
MM1043 1968-70 Plymouth	189.99 pr
E-Body	
MM1935* 1970-74 all	204.99 pr

Standard Replacement

A-Body	
MP41255 1963-66 all - LH	109.99 ea
MP41256 1963-66 all - RH	109.99 ea
MP41257 1967-69 Barracuda - LH	114.99 ea
MP41258 1967-69 Barracuda - RH	114.99 ea
B-Body	
MM1044A 1968-70 Dodge	149.99 pr



1968-69 Charger Inner Fender Splash Shields

Inner fender splash shields for 1968-69 Charger models. These stamped steel EDP coated replacements are mounted to the front fender and the valance panel.

MM1618 1968-69	89.99 pr
----------------	----------



1966-76 Front Splash Plates

These plates install behind the front wheel opening and often rust away. They connect the front frame rail to the inner rocker and the front torque box. Made in USA.

A-Body	
MM8174 1960-76 LH	64.99 ea
MM1964 1966-76 RH	64.99 ea
MM8175 1966-76 LH & RH	116.99 pr
B-Body	
MM8922 1966-70 LH	64.99 ea
MM8330 1966-70 RH	64.99 ea
E-Body	
MM8130 1970-74 LH	64.99 ea
MM8131 1970-74 RH	64.99 ea
MM8132 1970-74 LH & RH	134.99 pr



1966-74 K-Member Lower Splash Shields

Protect against dirt, water and rock damage by replacing cracked, torn or missing lower K-member splash shields. Mounting rivets are included and feature the correct straight, single or double angle bottom.

A-Body	
MM1821 1966-72 w/straight bottom	84.99 pr
MN2869 1973-74 w/double angle	84.99 pr
B-Body	
MM1821 1966-69 w/straight bottom	84.99 pr
MN2870 1969-72 w/single angle	84.99 pr
E-Body	
MN1821 1970-71 w/straight bottom	84.99 pr
MN2870 1970-72 w/single angle	84.99 pr
MN2869 1973-74 w/double angle	84.99 pr

1968-69 Splash Shield Screw Cap

Reproduction upper headlamp splash shield screw cap for 1968-69 Dodge B-Body models. This cap is used to cover the stud that goes through the inner fender next to each end of the radiator core support. These caps were used to prevent injuries. Two required per vehicle.

MN2117 1968-69 B-Body	5.99 ea
-----------------------	---------



1970-74 E-Body Splash Shield Hardware

Reproduction fender splash shield hardware for 1970-74 E-Body models. Manufactured to mount the splash shield to the rear end of the front fenders. Only one set required per vehicle.

MN3063 1970	15.99 set
MN3064 1971-74	11.99 set

Important Information Before Attempting To Install Sheet Metal!

Regarding Minor Imperfections in Panels:

The sheet metal you receive may have scratches, dings, small dents and other minor imperfections which are considered normal sheet metal characteristics due to the nature of the product. These minor imperfections will be easily corrected during the filling, priming and sanding phase of your sheet metal installation. Classic Industries® does not consider dings, scratches, minor dents or other imperfections on the sheet metal to be defects in the panel nor are they considered damaged. All sheet metal panels will require some sort of preparation and manipulation during installation. Every panel that we sell is inspected and then carefully packaged to protect against damage that may occur during transit.



OER ORIGINAL EQUIPMENT REPRODUCTION

Classic INDUSTRIES
Parts & Accessories

Test Fit All Panels Prior to Paint and Installation:

Classic Industries® recommends test fitting all sheet metal panels prior to final paint and installation. Minor modifications including elongating mounting holes, adding additional shims, etc. are normal and may be necessary when installing sheet metal. It is important to note that hard driving conditions, like racing, can twist bodies and frames out of original tolerances. Poor body work from previous collisions can cause problems with the body structure that the panels are attached to. Some vehicles were manufactured with a unitized body (no frame) thus causing even the most minor accident to twist the body creating a situation that would cause sheet metal panel mis-alignments. Take into consideration that tolerances on classic vehicles are not nearly as exact as they are on modern vehicles. This is primarily due to the hand fitting of panels at the factory on most antique and classic cars as opposed to the robotics used in today's modern factories. All of these factors will affect the way your new reproduction sheet metal will install and fit on the car. There is really no such thing as a direct fit body panel when it comes to older vehicles.

Returns and Defects:

Prior to returning any defective body panel or sheet metal item to Classic Industries®, please contact our customer service department. Classic Industries® will not replace a panel, nor will we be responsible for freight on returns should it be deemed that the panel is not defective. See policies for more information.

For Best Results, Hire a Professional to Install the Panels:

Classic Industries® recommends that you hire a professional paint and body technician that has the skills, knowledge and experience necessary to install the new panels on your vehicle. A professional body technician will be able to prepare the panels for installation and repair any imperfections.

When Welding Sheet Metal Products . . .

Save time when replacing sheet metal by using Classic Industries® new, innovative "Weld-Thru" primed sheet metal products. Our all new coating process is designed to eliminate the unnecessary process of grinding or sanding the EDP coating off to ensure a solid and rust free weld. This "Weld-Thru" primer requires minimal preparation and eliminates corrosion problems between overlapped panels and layered spot welds. It also minimizes heat zone problems, reduces panel distortion, and allows better penetration into the dense replacement steel to compensate for the older metal's impurities. Look for the "Weld-Thru" logo when purchasing sheet metal products to save time during installation of weld-on sheet metal repair panels.



Some Guidelines on EDP Coating

Many sheet metal products are delivered with a black electrophoretically deposited coating (EDP, or E-coat) for superior long-term corrosion protection, while others use a similar lacquer-based coating designed to provide protection for storage and shipping. Before panel installation, Classic Industries® recommends applying lacquer thinner with a shop towel to determine the type of coating. If the coating is removed by lacquer thinner, then it should be completely stripped from the product before any primer or paint is applied. If the lacquer thinner does not remove the EDP coating, it can simply be prepped, primed and painted without stripping.

Classic Industries® The Restorers Choice™

Count on the Classic Industries® Restorers Choice symbol whenever purchasing reproduction parts and accessories. You can be sure that each and every product displaying this symbol is manufactured correctly to exact specifications and fits the way the factory intended. Products denoted throughout the catalog with this symbol are officially approved by Classic Industries® as a genuine restoration product. Look for the Restorers Choice™ logo. The Classic Industries® symbol is your assurance of quality.



Made in the USA

Look for the "Made in the USA" logo for products that are proudly manufactured in the United States.



MOPAR Authentic Restoration Products

Classic Industries® advertises a variety of products with the above MOPAR Authentic Restoration Product logo. This logo indicates that the product is manufactured to MOPAR's specifications and licensed by Chrysler Group LLC as a MOPAR Authentic Restoration Product. Such products represent a prestigious class of restoration parts that are nearly identical to the original products offered by MOPAR in the 1960's and 1970's. MOPAR, DODGE, JEOP, and PLYMOUTH vehicles, images, and logos are trademarks of Chrysler Group LLC used under license. © Chrysler Group LLC 2012.

Body Repair Panels



1970 Challenger Weld-Thru™ Steel Skeleton

Weld-Thru Skeleton Are The Ultimate In Restoration!

New!



ME175918 - profile view



rear seat area



trunk and roof area



inner fender area



front view

Skeleton Features:

- Weld-Thru Coated
- Correct Gauge Steel
- 25% More Spot Welds
- Firewall for AC Vehicles
- Assembled as a One Piece Unit
- Front Under Floor Bracing
- Trunk Floor Bracing
- Roof Bracing

Kits Include:

- Door Shells
- Deck Filler Panel
- Door Hinges
- Trunk Lid
- Roof Panel
- Rear Tail Panel
- Quarter Panels

1970 Challenger Skeleton

If the body of your 1970 Challenger is rusted beyond individual panel replacement, these reproduction skeleton assemblies are the answer.

Important: All additional components are shipped uninstalled.

Note: Special order; must be prepaid. Shipped truck freight. Please check your state laws for registration. No farther discounts apply to the Skeleton kits.

Bare Skeleton

ME175918	1970 coupe - with air conditioning		8999.99 ea
R8097B	1970 w/Restorer's Choice components		10,389.99 kit
R8097A	1970 w/Standard Replacement components		9549.99 kit



MM1771A



MM1770A



1966-70 B-Body Cowl Panels

Factory-style replacement cowl panels for various 1966-70 B-Body models. Your choice of our Restorer's Choice panel, officially licensed by Mopar, manufactured in OE-gauge steel featuring all original contours, details and mounting points or our standard replacement for the car builder on a budget. Either choice comes finished in black EDP coating to prevent rust and is ready to prep, prime and paint to your desired color.

Note: Shipped double overice.

		Restorer's Choice	
MM1771B	1966-70	lower cowl panel.....	399.99 ea
MM1770B	1966-70	upper cowl panel.....	394.99 ea

		Standard Replacement	
MM1771A	1966-70	lower cowl panel.....	324.99 ea
MM1770A	1966-70	upper cowl panel.....	319.99 ea



New!



MM1979



1968-70 B-Body Firewall

Replacement firewall for 1968-70 B-Body models. This EDP coated panel features correct contours and openings for the steering column and other components. Your choice of our Restorer's Choice door skin, officially licensed by Mopar, manufactured in OE-gauge steel featuring all original contours and details or our standard replacement for the car builder on a budget. Available for models with or without air conditioning.

Note: Shipped truck freight.

		Restorer's Choice	
MM1906B	1968-70	without air conditioning.....	399.99 ea
MM1979B	1968-70	with air conditioning.....	399.99 ea

		Standard Replacement	
MM1906	1968-70	without air conditioning.....	349.99 ea
MM1979	1968-70	with air conditioning.....	349.99 ea



MM1378B



1970-74 E-Body Upper Cowl Panel

Factory-style replacement upper cowl panel without holes for 1970-74 E-Body models. Your choice of our Restorer's Choice panel, officially licensed by Mopar, manufactured in OE-gauge steel featuring all original contours and details or our standard replacement for the car builder on a budget. This panel was made two different ways, and the difference was how the plastic vent screens were attached to the cowl panel. The screens could either be held by small plastic clips or by small Phillips screws. The panels that we offer for the clip style screen come with pre-cut square holes for the clips and the screw style panel does not come with any mounting holes for the vent screen.

Note: Shipped double overice.

		Restorer's Choice	
MM1377	1970-74	clip style.....	368.99 ea
MM1378B	1970-74	screw style.....	404.99 ea

		Standard Replacement	
MM1378A	1970-74	screw style.....	324.99 ea

Body Repair Panels



MM1380B



1970-74 E-Body Firewall/Lower Cowl Panel

Replacement firewall/lower cowl panel for 1970-74 Mopar E-Body models. Your choice of our Restorer's Choice panel, officially licensed by Mopar, manufactured in OE-gauge steel featuring all original contours and details or our standard replacement for the car builder on a budget. Replace your rusted original with either of these replacement panels and repair the structural integrity of your E-Body. Either choice comes finished in black EDP coating to prevent rust.

Note: Shipped truck freight.

Restorer's Choice

MM1379B	1970-74	w/o air conditioning	494.99 ea
MM1380B	1970-74	w/air conditioning	494.99 ea

Standard Replacement

MM1379A	1970-74	w/o air conditioning	389.99 ea
MM1380A	1970-74	w/air conditioning	389.99 ea



1970-74 E-Body Firewall/Cowl Panel Assembly

Replacement firewall/cowl panel for 1970-74 Barracuda and Challenger models originally equipped with air conditioning. Stamped from quality steel with correct contours, this panel is a good replacement for your original. Features the upper cowl panel welded onto the lower cowl/firewall panel. Features EDP coating for rust prevention, and uses screws to mount the cowl screens.

Note: Shipped truck freight.

ME8146A	1970-74	with AC	799.99 ea
---------	---------	---------	-----------



MM1896W

MM1904

1968-74 Inner Cowl Side Hinge Panels

Factory-style replacement inner cowl side hinge panels for 1968-74 B-Body and E-Body models. Your choice of our Restorer's Choice panel, officially licensed by Mopar, manufactured in OE-gauge steel featuring all original contours and details or our standard replacement for the car builder on a budget. Comes finished in your choice of EDP or Weld-Thru™ coating. Sold individually.

Restorer's Choice

MM1896B	1970-74	LH	E-Body	EDP coated	164.99 ea
MM1897B	1970-74	RH	E-Body	EDP coated	164.99 ea

Standard Replacement

MM1904	1968-70	LH	B-Body	EDP coated	164.99 ea
MM1905	1968-70	RH	B-Body	EDP coated	164.99 ea
MM1896A	1970-74	LH	E-Body	EDP coated	129.99 ea
MM1897A	1970-74	RH	E-Body	EDP coated	129.99 ea
MM1896W	1970-74	LH	E-Body	Weld Thru™ coated	129.99 ea
MM1897W	1970-74	RH	E-Body	Weld Thru™ coated	129.99 ea



MM1112

1970-74 E-Body Windshield Corner/Cowl Patch Panel

With these lower windshield patch panels, you can repair this commonly rusted area without having to replace the entire windshield frame. These panels fit 1970-74 Challenger, 'Cuda and Barracuda models. Installs behind the upper door hinge.

MM1110	1970-74	LH	cowl patch panel	94.99 set
MM1111	1970-74	RH	cowl patch panel	94.99 set
MM1112	1970-74	LH/RH	cowl patch panel set	179.99 set

New!



MM1140B



1970-74 E-Body Windshield A-Pillar Post

Reproduction windshield A-Pillar post for 1970-74 Dodge and Plymouth E-Body models. This post supports the windshield and runs from the front corner of the roof to the upper door hinge area. Available as the outer pillar or a welded 3 piece assembly for a complete pillar replacement. Your choice of a Restorer's Choice panel, officially licensed by Mopar, manufactured in OE-gauge steel featuring all original contours, details and mounting points or a standard replacement for the car builder on a budget. Either choice comes finished in black EDP coating to prevent rust, ready to prep, prime and paint to your desired color.

Restorer's Choice

MM1140B	1970-74	LH	outer pillar	149.99 ea
MM1141B	1970-74	RH	outer pillar	149.99 ea

Standard Replacement

MM1140A	1970-74	LH	outer pillar	119.99 ea
MM1141A	1970-74	RH	outer pillar	119.99 ea
MM1962	1970-74	LH	complete pillar	299.99 ea
MM1963	1970-74	RH	complete pillar	299.99 ea

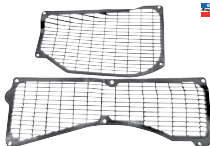

ME1561

1970-74 E-Body Cowl Grills

Replacement cowl grills for 1970-74 Barracuda and Challenger models. These grills are mounted to the cowl panel and are cut and molded just like the originals.

ME1561	1970-74	104.99 pr
--------	---------	-----------

ME1562	1972-74	104.99 pr
--------	---------	-----------



MD2088



MD2089



1962-74 Cowl Drain Flap

Replacement rubber drain flap that installs on the cowl and body side. For 1962-74 Mopar A-Body, B-Body and E-Body models. Made in USA.

MD2088	1962-65	all models	3.99 ea
MD2089	1966-74	all models	6.99 ea

Rocker Repair Panels



MM1161B



1967-76 Outer Rockers

MM1161A

Reproduction outer rocker panel for various 1967-76 models. Installed between the front and rear wheel wells, the rocker panels are often damaged or rust out over the years. Replace them with these all new outer rockers. Your choice of our Restorer's Choice panel, officially licensed by Mopar, manufactured in OE-gauge steel featuring all original contours and details or our standard replacement for the car builder on a budget. Comes finished in black EDP coating to prevent rust and is ready to prep and paint to your desired color.

Note: Shipped double oversize.



Restorer's Choice

A-Body	Year	Model	Price
MM2259	1967-69	LH Barracuda	239.99 ea
MM2260	1967-69	RH Barracuda	239.99 ea
MM2257	1967-76	LH Dart	239.99 ea
MM2258	1967-76	RH Dart	239.99 ea
MM2259	1970-76	LH Duster, Demon, Dart Sport	239.99 ea
MM2260	1970-76	RH Duster, Demon, Dart Sport	239.99 ea

B-Body	Year	Model	Price
MM1157B	1968-70	LH all	289.99 ea
MM1158B	1968-70	RH all	289.99 ea

E-Body	Year	Model	Price
MM1159B	1970-74	LH Barracuda	289.99 ea
MM1160B	1970-74	RH Barracuda	289.99 ea
MM1161B	1970-74	LH Challenger	289.99 ea
MM1162B	1970-74	RH Challenger	289.99 ea

Standard Replacement

B-Body	Year	Model	Price
MM1157A	1968-70	LH all	229.99 ea
MM1158A	1968-70	RH all	229.99 ea

E-Body	Year	Model	Price
MM1159A	1970-74	LH Barracuda	229.99 ea
MM1160A	1970-74	RH Barracuda	229.99 ea
MM1161A	1970-74	LH Challenger	229.99 ea
MM1162A	1970-74	RH Challenger	229.99 ea

New!



MM1909



1966-76 Front Inner Rocker Panel

Replacement front inner rocker panels for various 1966-76 models. This EDP coated piece replaces only the front inner section of the rocker panel and features correct contours.

Note: Shipped oversize.



Restorer's Choice

A-Body	Year	Model	Price
MA822058	1967-76	LH Dart	169.99 ea
MA822059	1967-76	RH Dart	169.99 ea

E-Body	Year	Model	Price
MM1987	1970	LH Barracuda	109.99 ea
MM1988	1970	RH Barracuda	109.99 ea
MM1989	1971-74	LH Barracuda	109.99 ea
MM1990	1971-74	RH Barracuda	109.99 ea
MM1991	1970	LH Challenger	109.99 ea
MM1992	1970	RH Challenger	109.99 ea
MM1993	1971-74	LH Challenger	109.99 ea
MM1994	1971-74	RH Challenger	109.99 ea

Standard Replacement

B-Body	Year	Model	Price
MM1909	1966-70	LH except convertible	79.99 ea
MM1910	1966-70	RH except convertible	79.99 ea

E-Body	Year	Model	Price
MM1911	1970	LH coupe	79.99 ea
MM1912	1970	RH coupe	79.99 ea
MM1913	1971-74	LH coupe	79.99 ea
MM1914	1971-74	RH coupe	79.99 ea



1968-70 B-Body Inner Rocker

MM8094

This is a full length inner rocker made from heavy-duty 11 gauge steel, CNC cut to ensure an exact fit. Available individually or save by ordering the pair. Replaces the inner rocker from the front door to the rear of the quarter panel. Made in USA.
MM8094 1966-70 LH or RH 89.99 ea
MM8096 1966-70 LH & RH 189.99 pr



ME5051

1968-74 Mopar B & E-Body Rear Inner Rocker Panels

Factory-style inner rocker panel for 1966-70 hard top B-body and 1970-74 E-Body models. Features correct contours and comes EDP coated for rust prevention.

B-Body	Year	Model	Price
MB1890	1966-70	LH, all - exc convertible	49.99 ea
MB1891	1966-70	RH, all - exc convertible	49.99 ea

E-Body	Year	Model	Price
ME5049	1970-74	Barracuda coupe	49.99 ea
ME5050	1970-74	Barracuda coupe	49.99 ea
ME5051	1970-74	Challenger coupe	49.99 ea
ME5052	1970-74	Challenger coupe	49.99 ea



1968-76 Rust Repair Outer Rocker Panels

MM836001

Rocker panels install directly below the door between the front and rear wheel openings. These 18 gauge steel patch panels are manufactured to match the original contours and used to repair a damaged or rusted outer rocker panel and a portion of the sill plate area. Made in USA.

Note: Shipped double oversize.



A-Body

MM836001	1966-76	LH	2 door, except Barracuda	24.99 ea
MM836002	1966-76	RH	2 door, except Barracuda	24.99 ea
MM836003	1967-69	LH	Barracuda	24.99 ea
MM836004	1967-69	RH	Barracuda	24.99 ea

B-Body

MM836005	1966-67	LH	Charger/Coronet	24.99 ea
MM836006	1966-67	RH	Charger/Coronet	24.99 ea
MM836007	1968-70	LH	Charger	24.99 ea
MM836008	1968-70	RH	Charger	24.99 ea
MM836009	1971-74	LH	Charger	24.99 ea
MM836010	1971-74	RH	Charger	24.99 ea
MM836011	1968-70	LH	all except Charger	24.99 ea
MM836012	1968-70	RH	all except Charger	24.99 ea
MM836013	1971-74	LH	Satellite/Road Runner	24.99 ea
MM836014	1971-74	RH	Satellite/Road Runner	24.99 ea

E-Body

MM836015	1970-74	LH	Barracuda/Challenger	24.99 ea
MM836016	1970-74	RH	Barracuda/Challenger	24.99 ea

1967-76 Rocker Panel End Caps



Replacement rocker panel end caps for various 1967-76 A, B and E-Body models. Manufactured to factory specifications from heavy gauge steel, these end caps will allow for easier rocker panel installation.



MM1795

MM1796

A-Body	Year	Model	Price
MM1791	1967-76	LH	19.99 ea
MM1792	1967-76	RH	19.99 ea

B-Body	Year	Model	Price
MM1793	1968-70	LH	19.99 ea
MM1794	1968-70	RH	19.99 ea

E-Body	Year	Model	Price
MM1795	1970-74	LH	19.99 ea
MM1796	1970-74	RH	19.99 ea

Door Repair Panels



MM1928

MM1928
inner view

1968-74 Complete Door Shells

Reproduction complete door shells for 1968-70 B-Body models and 1970-74 E-Body models. This complete shell is just what you'll need if replacing the outer sheet metal panel is simply not enough. Simply remove the original components from the existing door and install them into the new shell. Your choice of our Restorer's Choice door shell, officially licensed by Mopar, manufactured in OE-gauge steel featuring all original contours and details or our standard replacement for the car builder on a budget.

Note: Shipped truck freight.

Restorer's Choice

MM1163	1968	LH	B-Body except Charger	619.99 ea
MM1164	1968	RH	B-Body except Charger	619.99 ea
MM1165	1969-70	LH	B-Body except Charger	619.99 ea
MM1166	1969-70	RH	B-Body except Charger	619.99 ea
MM1167	1968	LH	Charger	619.99 ea
MM1168	1968	RH	Charger	619.99 ea
MM1169	1969-70	LH	Charger	619.99 ea
MM1170	1969-70	RH	Charger	619.99 ea

Standard Replacement

MM1928	1970-74	LH	Challenger	564.99 ea
MM1929	1970-74	RH	Challenger	564.99 ea

New!



MM3168

1968-74 Outer Door Skins

Replacement door skins for 1968-74 models. Stamped from heavy gauge sheet metal, each door skin features correct original contours and slotting for the door handle and lock. Your choice of a Restorer's Choice door skin, officially licensed by Mopar, manufactured in OE-gauge steel featuring all original contours and details or our standard replacement for the car builder on a budget.

Note: Shipped double oversize.

Restorer's Choice

A-Body				
MM3166	1968-72	LH	Dart/Scamp	319.99 ea
MM3167	1968-72	RH	Dart/Scamp	319.99 ea
MM3168	1970-72	LH	Duster/Demon	319.99 ea
MM3169	1970-72	RH	Duster/Demon	319.99 ea

B-Body				
MM1124	1968-70	LH	B-Body except Charger	294.99 ea
MM1125	1968-70	RH	B-Body except Charger	294.99 ea
MM1126	1968-70	LH	Charger	294.99 ea
MM1127	1968-70	RH	Charger	294.99 ea

E-Body				
MM1010	1970-74	LH	Barracuda	294.99 ea
MM1011	1970-74	RH	Barracuda	294.99 ea
MM1086B	1970-74	LH	Challenger	294.99 ea
MM1087B	1970-74	RH	Challenger	294.99 ea

Standard Replacement

E-Body				
MM1086A	1970-74	LH	Challenger	229.99 ea
MM1087A	1970-74	RH	Challenger	229.99 ea

New!



MP41266

1963-66 A-Body Door Skin Patch Panel

Replacement lower door skin for 1963-66 Dodge and Plymouth A-Body models. These panels are stamped in original-gauge sheet metal and designed to replace the commonly rusted area on A-Body doors. Fits Dart, Barracuda and Valiant models. Measures 49" long and 9 1/2" tall.

MP41266	1963-66	LH	149.99 ea
MP41267	1963-66	RH	149.99 ea

1967-78 Door Jamb Lock Pillars

Replacement door jamb lock pillar area for various 1967-78 models. This panel is often rusted or damaged around the door striker area. Your choice of a Mopar officially licensed "Restorer's Choice" panel, manufactured in OE-gauge steel featuring all original contours and details or our standard replacement for the car builder on a budget. Comes finished in semi-flat black EDP coating to prevent rust and is ready to prep and paint to your desired color.



MM1362B

MM1361B

Restorer's Choice

A-Body				
MM1353	1967-76	LH	Dart	189.99 ea
MM1354	1967-76	RH	Dart	189.99 ea
MM1355	1970-76	LH	Duster/Demon/Dart Sport	189.99 ea
MM1356	1970-76	RH	Duster/Demon/Dart Sport	189.99 ea

B-Body

MM1359	1968-70	LH	sedan	189.99 ea
MM1360	1968-70	RH	sedan	189.99 ea
MM1361B	1968-70	LH	hardtop except Charger	189.99 ea
MM1362B	1968-70	RH	hardtop except Charger	189.99 ea
MM1357	1968-70	LH	Charger	189.99 ea
MM1358	1968-70	RH	Charger	189.99 ea

E-Body

MM1363B	1970-74	LH	Barracuda hardtop	179.99 ea
MM1364B	1970-74	RH	Barracuda hardtop	179.99 ea
MM1365B	1970-74	LH	Challenger hardtop	179.99 ea
MM1366B	1970-74	RH	Challenger hardtop	179.99 ea

Standard Replacement

B-Body				
MM1361A	1968-70	LH	hardtop except Charger	149.99 ea
MM1362A	1968-70	RH	hardtop except Charger	149.99 ea
MM1524	1971-72	LH	hardtop	179.99 ea
MM1525	1971-72	RH	hardtop	179.99 ea

E-Body

MM1363A	1970-74	LH	Barracuda hardtop	149.99 ea
MM1364A	1970-74	RH	Barracuda hardtop	149.99 ea
MM1365A	1970-74	LH	Challenger hardtop	114.99 ea
MM1366A	1970-74	RH	Challenger hardtop	114.99 ea

New!



MP41270

MP41271

1967-76 Door Jamb Plate

Door jamb repair plates for 1967-76 A-Body and 1968-70 B-Body models. These embossed steel repair plates weld into the door latch area to replace the fatigued or cracked metal. Includes instructions for installation.

A-Body

MP41268	1967-76	LH	99.99 ea
MP41269	1967-76	RH	99.99 ea

B-Body

MP41270	1968-70	LH	79.99 ea
MP41271	1968-70	RH	79.99 ea



MM1915

MM1916

1968-74 Lower Hinge Pillar

Replacement lower door pillar assembly for 1970-74 E-Body and 1968-70 B-Body models. This EDP-coated piece is the mounting point for the lower door hinge.

B-Body

MM3340	1968-70	LH	154.99 ea
MM3341	1968-70	RH	154.99 ea

E-Body

MM1915	1970-74	LH	154.99 ea
MM1916	1970-74	RH	154.99 ea

Door Hardware

New!



MM1965

MR280972

1962-74 Door Hinges

These replacement door hinges for 1962-74 models are perfect for restoring the alignment of the doors and ensure that they open and close the way the factory intended.

A-Body	MM1965	1967-74	4 pieces.....	204.99 set
B-Body	MB280972	1962-65	4 pieces.....	249.99 set
	MM1966	1966-70	4 pieces.....	209.99 set
	MM1895	1971-74	4 pieces.....	224.99 set
E-Body	MM1391	1970-74	LH, upper.....	78.99 ea
	MM1392	1970-74	LH, lower.....	78.99 ea
	MM1393	1970-74	RH, upper.....	78.99 ea
	MM1394	1970-74	RH, lower.....	78.99 ea
	MM1967	1970-74	4 pieces.....	209.99 set

MR280983

1966-74 Door Hinge Bolt Sets

Reproduction door hinge bolt set for various 1966-74 models. Manufactured to look and fit like the originals.

B-Body	MB280983	1966-70	lower bolt set	26.99 set
	MB280984	1966-70	upper bolt set	21.99 set
E-Body	ME175940	1970-74	lower bolt set	35.99 set
	MB280984	1970-74	upper bolt set	21.99 set



MM1773

1962-74 A, B & E-Body Door Hinge Spring

When rebuilding your door hinges, don't stop with just pins and bushings, be sure to replace worn out hinge springs at the same time.

MM1773	1962-65	B-Body.....	17.99 ea
MM1774	1966-74	A, B & E-Body.....	17.99 ea



1971-74 B-Body Door Hinge Pin Rebuild Set

Replacement door hinge pin rebuild set for all 1971-74 two door Dodge and Plymouth B-Body models. This set includes all correct hardware needed to repair the hinges on both doors.

MB1846	1971-74	rebuild set.....	44.99 set
--------	---------	------------------	-----------

MR280983



EZ Rest Door Hanger

The EZ Rest Door Hanger enables a single person to quickly remove and/or install vehicle doors. The padded, removable side rails and plastic, ribbed base inserts allow for accurate positioning of the door. The easy on/off design quickly adapts to most floor jacks with a removable saddle and 30mm (1.18") diameter saddle hole. *Note: Floor jack not included.*

S21870	EZ Rest door hanger.....	116.99 ea
--------	--------------------------	-----------



Door Aligning Bar

Finally, a convenient door aligning tool that will fit in your tool drawer! Features a hex stub for use with a breaker bar and socket for additional leverage.

S21845	aligning bar.....	31.99 ea
--------	-------------------	----------



Door Hinge Adjuster Tool

When it comes to adjusting the door hinges so they accurately align with the body of the car, you might find most novice rebuilders frustrated. You can now easily adjust the hinges without the aggravation of trying to align by eyesight with this handy tool. Specifically designed to help adjust the hinges so they help to align the door.

Y65800	door adjuster tool.....	57.99 ea
--------	-------------------------	----------

New!



1970-76 Stainless Door Lock Strikers

Replacement door lock strikers for various 1970-76 Mopar models. Manufactured to function and fit like the original, but manufactured in bright stainless steel.

MN2116	1970-76.....	64.99 pr
--------	--------------	----------

AUTORIZED

AUTHORITATIVE RESTORATION



1970-76 Door Lock Striker

Replacement door lock striker for all 1970-76 two door Mopar models. The door lock striker is installed on the door jamb for either the RH or LH door. Sold individually. 2 required per car.

ME8152	1970-76	all.....	19.99 ea
--------	---------	----------	----------

AUTORIZED

AUTHORITATIVE RESTORATION



2862770



2862770 back

1968 A-Body Door Latches

Reproduction of the door latches for 1968 A-body vehicles including Dodge Dart, Plymouth Barracuda and Valiant models.

2862771	1968	LH.....	79.99 ea
2862770	1968	RH.....	79.99 ea



1962-74 Door Lock Rod Clip

The door lock rod clip attaches the outer door handle to the door latch assembly to open the door. This clip is often the cause of a broken outer door handle.

MN1768	1962-74	all.....	.99 ea
--------	---------	----------	--------

New!

AUTORIZED



1969-76 Door Lock Rod Retaining Clip

Reproduction of the nylon clip that retains the inner two door lock rods. Sold individually. One required per door. Fits into a 1/16" hole and secures a 5/32" rod. K4013

K4013	1969-76.....	1.99 ea
-------	--------------	---------

New!



MN1856

1966-74 Door Latch/Lock Clip Sets

Keep your door working properly by replacing the door latch/lock clips with these correct style clips. Sets are available for various 1966-74 models.

MN2100	1967-72	A-Body.....	12.99 set
MN1855	1966-67	B-Body.....	29.99 set
MN1856	1968-70	B-Body.....	29.99 set
MN2101	1971-72	B-Body.....	10.99 set
MN2725	1970-71	E-Body.....	10.99 set
MN2726	1972	E-Body.....	10.99 set
MN2727	1973-74	E-Body.....	10.99 set

Door Mirrors



AUTHORIZED

1963-74 A-Body Mirrors



Door mirrors for various 1963-74 A-Body models. These quality replacements that feature correct chrome plating, factory mounting points and are available for vehicles with or without the remote option. Mounting hardware is included.

Manual Mirrors

MD2206	1963-66	LH	twin post	119.99 ea
2802869	1967-74	RH	round type	129.99 ea
MD20710	1967-74	LH	129.99 ea
MA1579	1970-73	RH	racing mirror	189.99 ea

Remote Mirrors

MD2207	1966-72	LH	w/vent window	184.99 ea
MA1578	1970-73	LH	racing mirror	254.99 ea



AUTHORIZED

1962-74 B-Body Mirrors



Replace the mirrors on your 1962-74 B-Body vehicle with quality replacements produced in correct chrome finish or ready to prep and paint in your choice of factory original colors. Mirrors are available for vehicles originally equipped with manual adjustment or remote adjustment mirror option. Mounting hardware is included.

Note: Primer color may vary on primed mirrors.

Manual Mirrors

MD2206	1962-66	LH	chrome	twin post	119.99 ea
2802869	1968-70	RH	chrome	129.99 ea
MD20710	1968-70	LH	chrome	129.99 ea
MD2211	1971-72	RH	chrome	racing mirror	184.99 ea
MD2213	1971-72	RH	primered	174.99 ea
MB2330	1973-74	RH	chrome	184.99 ea
MB2332	1973-74	RH	primered	194.99 ea

Remote Mirrors

MD2207	1966-70	LH	chrome	184.99 ea
MD2210	1971-72	LH	chrome	racing mirror	224.99 ea
MD2212	1971-72	LH	primered	racing mirror	214.99 ea
MB2329	1973-74	LH	chrome	224.99 ea
MB2331	1973-74	LH	primered	214.99 ea



AUTHORIZED

1970-74 E-Body Mirrors



Replace the mirrors on your 1970-74 E-Body vehicle with quality replacements produced in correct chrome finish or ready to prep and paint in your choice of factory original colors. Mirrors are available for vehicles originally equipped with manual adjustment or remote adjustment mirror option. Mounting hardware is included.

Note: Primer color may vary on primed mirrors.

Manual Mirrors

ME1642	1970	RH	chrome	racing mirror	169.99 ea
ME1644	1970	RH	primered	racing mirror	94.99 ea
ME1645	1970	LH	chrome	round mirror	184.99 ea
ME1646	1971	LH	chrome	round mirror	184.99 ea
MD2211	1971-74	RH	chrome	racing mirror	184.99 ea
MD2213	1971-74	RH	primered	racing mirror	174.99 ea

Remote Mirrors

ME1641	1970	LH	chrome	racing mirror	169.99 ea
ME1643	1970	LH	painted	racing mirror	94.99 ea
MD2210	1971-74	LH	chrome	racing mirror	224.99 ea
MD2212	1971-74	LH	primered	racing mirror	214.99 ea



1968-74 Mirror Mounting Gaskets

Replacement rubber mirror mount pads for various 1968-74 models.

A-Body			
MD2093	1968-70	w/remote	8.99 ea
MD2098	1970	w/racing mirrors	8.99 ea

B-Body

MD2093	1968-70	w/remote	8.99 ea
MD2098	1970	w/racing mirrors	8.99 ea
MD2091	1971-74	all	19.99 pr

E-Body

MD2098	1970	w/racing mirrors	8.99 ea
MD2091	1971-74	all	19.99 pr

New!



1970-74 Mirror Mounting Set

Reproduction mirror mounting set for 1971-74 B-Body and 1970-74 E-Body models. Every set includes four screws and threaded retainers.

MN2882	1970-74	B/E-Body	10.99 set
--------	---------	----------	-----------

AUTHORIZED



1968-67 B-Body Remote Mirror Bezel

Reproduction of the chrome remote mirror mechanism bezel originally installed on 1966-67 Mopar B-Body vehicles with a drivers side remote mirror. This chrome bezel attaches the remote mechanism to the door.

MB1472	1966-67	9.99 ea
--------	---------	-------	---------



1970-74 B & E-Body Remote Mirror Bezel

Chrome remote mirror bezel for 1970-74 models. This bezel mounts inside the door to give the remote mechanism additional support.

MB1247	1971-74	B-Body	15.99 ea
ME754	1970-74	E-Body	15.99 ea

1968-76 Mirror Bezel Nut Tools

These mirror bezel nut tools are designed to interlock with the recessed dimples on the outside of your bezel nut to avoid scratching your chrome. Avoid destroying your original bezel nut or install a new nut without damaging it with this special tool. Made in USA.



MF1737	1966-67	all	12.99 ea
MF1737	1968-76	all	10.99 ea

Door Components

AAO AUTHORIZED

AUTHENTIC RESTORATION



MA1097

MB2262

1963-70 A-Body Outer Door Handle Sets

These convenient sets of handles replace pitted, worn or inoperative door handle assemblies perfectly. Each set includes 2 outer handles, 2 handle to body gasket sets, 2 push buttons, 2 O-rings and mounting hardware, completely assembled and ready to install. Will fit 1963-70 A-Body vehicles.

MA1097 1963-66 w/chrome buttons ... 99.99 set
MB2262 1967-70 w/chrome buttons ... 114.99 set
MD4231 1968-69 w/black buttons ... 114.99 set

AAO AUTHORIZED

AUTHENTIC RESTORATION



1962-65 B-Body Outer Door Handle Set

This convenient set of handles replaces pitted, worn or inoperative door handle assemblies on 1962-65 B-Body vehicles perfectly. Each set includes 2 outer handles, 2 handle to body gasket sets, 2 chrome push buttons, 2 O-rings and mounting hardware, completely assembled and ready to install. Will fit a variety of 1962-65 B-Body vehicles including 1962-64 Belvedere, Fury, Savoy, Sport Fury, 330, 440, Polara, Polara 500 and 1965 Coronet, Satellite models.

MB248 1962-65 w/chrome buttons ... 99.99 set

AUTHENTIC RESTORATION



MB250

1966-67 B-Body Outer Door Handle Sets

These convenient sets of handles replaces pitted, worn or inoperative door handle assemblies on 1966-67 B-Body vehicles perfectly. Each set includes 2 outer handles, 2 handle to body gasket sets, 2 push buttons, 2 O-rings and mounting hardware, completely assembled and ready to install. Available with your choice of chrome or black push buttons; this set is for 1966-67 B-Body vehicles. Made in USA.

Note: 1966-67 models originally came equipped with chrome buttons from the factory. Black buttons are offered for those wishing to achieve a custom look.

MB249 1966-67 w/chrome buttons ... 99.99 set
MB250 1966-67 w/black buttons ... 94.99 set

AAO AUTHORIZED

AUTHENTIC RESTORATION



MB2262

MD4231

1968-70 B-Body Outer Door Handle Sets

This convenient set of handles replaces pitted, worn or inoperative door handle assemblies on 1968-70 B-Body vehicles perfectly. Each set includes 2 outer handles, 2 handle to body gasket sets, 2 push buttons, 2 O-rings and mounting hardware, completely assembled and ready to install. Available with chrome or black buttons

MB2262 1968-70 w/chrome buttons ... 114.99 set
MD4231 1968-69 w/black buttons ... 114.99 set

AAO AUTHORIZED

AUTHENTIC RESTORATION



ME1591

Profile view

ME1592

Profile view

Correct Curvature

Flat Profile

1970-74 E-Body Outer Door Handles

Reproduction outer door handles for 1970-74 Barracuda, "Cuda and Challenger models. While some suppliers offer a universal handle designed to fit both E-Body models, ours are more authentic in appearance and fit, feature original contours, correct finish and are pre-assembled ready to install. Mounting gaskets are included.

ME1591 1970-74 Barracuda 141.99 set
ME1592 1970-74 Challenger 141.99 set

AAO AUTHORIZED

AUTHENTIC RESTORATION



MB2297

1971-74 B-Body Outer Door Handles

Outer door handles for 1971-74 B-Body models. Features correct chrome finish, original contours, tension springs and mounting hardware.

MB2296 1971-72 outer door handles ... 109.99 set
MB2297 1973-74 outer door handles ... 109.99 set

New!



Made in USA

Lokar 12V Exterior Door Handles

Elevate your vehicle's style with these electronic exterior door handles from Lokar! Each billet door handle utilizes a weatherproof 12 volt pressure-pad switch to supply power to an electronically actuated door latch (door popper). Its two-piece design allows the insert to be removed for customization. Made in USA from 6061 T-6 billet aluminum.

Note: Requires electronic door latch actuators, not included.

GSE1100A handles brushed 341.99 pr
GSE2100B handles polished 341.99 pr

AUTHENTIC RESTORATION



MB251

MB252

MB253

Made in USA

1962-67 B-Body Door Handle Push Buttons

Replacement door handle push buttons for 1962-67 B-Body models. Includes 2 buttons, 2 rods and 2 O-rings.

Note: 1966-67 models originally came equipped with chrome buttons from the factory. Black buttons are offered for those wishing to achieve a custom look.

MB251 1962-65 chrome button set ... 41.99 set
MB252 1966-67 chrome button set ... 41.99 set
MB253 1966-67 black button set ... 34.99 set

AUTHENTIC RESTORATION



MD2102

1967-76 Outer Door Handle Gaskets

Four piece set of door handle mounting pads for 1967-76 A-Body, 1962-76 B-Body and 1970-74 E-Body models. Made in USA.

MD2102 1967-76 A-Body 5.99 set
MB254 1962-65 B-Body 6.99 set
MB255 1966-67 B-Body 6.99 set
MD2102 1968-70 B-Body 5.99 set
ME541 1970-74 E-Body 5.99 set

New!



MN2111

1967-74 Door Lock Link Rods

Reproduction door lock link rods for various 1967-74 two door models. These rods connect the door lock cylinders to the door latch assembly, and are manufactured in the correct diameter stainless steel wire.

MN2111 1967-72 A-Body 18.99 pr
MN2112 1968-70 B-Body exc Charger 18.99 pr
MN2113 1970-74 E-Body 18.99 pr

Door Window Components



PDL5165

Power Door Lock Conversion Sets

Looking to convert your manual door locks to a full power remote system? The combination power door lock and keyless entry system will convert your old manual locks to power and activate them from up to 100 feet away! Power door lock sets include two 4-button keyless remotes, two 15 lbs actuators for the door locks, wire harness, mounting hardware and trunk lock actuator and alarm where applicable.

Power Door Lock Conversion Set
PDL5120 144.99 set

Power Door Lock and Trunk Conversion Set
PDL5170 169.99 set

Power Door Lock and Trunk Set with Alarm
PDL5165 179.99 set

MOB AUTHORIZED

AUTHENTIC RESTORATION



MES148

1970-72 E-Body Door Glass Guides

Reproduction of the door glass channel guides on 1970-72 Barracuda and Challenger models. Used to guide the door glass as it moves up and down inside the door. Every set includes the front guide, rear guide, and the front lower retainer bracket.

Note: These guides are correct for 1970-72 models but will fit and function on 1973-74 models with the correct 1970-72 glass hardware.

ME1848 1970-72 LH - 3 piece 89.99 set
ME1849 1970-72 RH - 3 piece 89.99 set

MOB

AUTHENTIC RESTORATION



MM1787

1968-74 Door Window Regulators

Reproduction door window regulators for 1966-70 B-Body 2-door models and 1970-74 E-Body models. Officially licensed Mopar Authentic Restoration Product®.

1966-70 B-Body Models

MM1088 1966-70 LH 129.99 ea
MM1089 1966-70 RH 129.99 ea

1970-74 Barracuda, Cuda Models

MM1780 1970 LH 159.99 ea
MM1781 1970 RH 159.99 ea
MM1782 1971-74 LH 159.99 ea
MM1783 1971-74 RH 159.99 ea

1970-74 Challenger Models

MM1784 1970 LH 159.99 ea
MM1785 1970 RH 159.99 ea
MM1786 1971-74 LH 159.99 ea
MM1787 1971-74 RH 159.99 ea



1966-74 Quarter Window Roller Sets

Replacement quarter window roller sets for various 1966-74 models. Each set includes all the necessary hardware and rollers to repair the two quarter windows.

MA1099 1967-72 A-Body 79.99 set
MB1770 1966-70 B-Body 79.99 set
ME8142 1970-74 E-Body 31.99 set

New!

1973-76 A-Body Door Window Rollers

Reproduction door window roller set for 1973-76 A-Body models. Manufactured to factory specifications designed to fit and work just like the originals. Only one set required per vehicle.

MN2105 1973-76 39.99 set

New!



1966-74 Door Window Hardware Set

Replace damaged or missing components and keep your windows working smoothly. With correct hardware, available for various 1966-74 models, each set includes enough hardware to repair both door windows.

A-Body

MN2878 1967-72 22 pieces 50.99 set

B-Body

MN2879 1966-70 8 pieces 44.99 set
MN2880 1971-72 28 pieces 48.99 set

E-Body

ME8140 1970-72 18 pieces 79.99 set
ME8141 1973-74 22 pieces 64.99 set



1966-74 Window Regulator Arm Clip

Replacement window regulator arm clip for all 1966-74 models. This clip mounts where the window regulator arm meets the window glass roller.

MM1769 1966-74 all 49 ea

New!



1970-74 B & E-Body Glass Up Stop

Reproduction glass up stop for 1971-74 B-Body and 1970-74 E-Body models. This piece is used in 2 different places, it is the door glass up stop on B-Body models, and the quarter glass up stop on E-Body models.

MN2119 1971-74 B-Body door glass... 5.99 ea
MN2119 1970-74 E-Body quarter glass 5.99 ea



MM1766

MM1767

1968-74 B & E-Body Door Glass Guides

Worn door glass guides can cause your window to rattle and can even lead to fine scratches in the glass just from being rolled up and down! Replace your broken or missing guides to prevent this potentially costly problem.

MM1766 1968-72 B-Body, rear door... 3.99 ea
MM1767 1970-74 E-Body 3.99 ea



1963-76 2 Power Window Sets

Enjoy fresh air at the flick of a switch! Front power window sets are available for 1963-76 Mopar models, which include window motors, glass regulators, and all necessary hardware for installation in the front windows. Alternatively, you can upgrade front or rear crank windows with the patented universal power window sets. These connect a motor to the existing crank mechanism with a flexible shaft and work with any manual window application, front or rear. Purchase one of the listed switch and harness sets to complete your installation.

Note: For front windows on 2-door models only.

A-Body

MD650101 1963-66 Dart hrdtp 289.99 set
MD650101 1963-66 Valiant 289.99 set
MD650101 1964-66 Barracuda 289.99 set
MD650102 1973-76 Dart 289.99 set
MD650102 1973-76 Dart Sport 289.99 set
MD650102 1973-76 Demon 289.99 set
MD650102 1973-76 Duster 289.99 set

B-Body

MD650103 1966-70 Belvedere 289.99 set
MD650103 1966-70 Coronet, R/T 289.99 set
MD650103 1966-70 Satellite 289.99 set
MD650103 1967-70 GTX 289.99 set
MD650103 1968-70 Charger 289.99 set
MD650103 1968-70 Road Runner 289.99 set
MD650103 1968-70 Super Bee 289.99 set
MD650104 1971-74 Charger 289.99 set
MD650104 1971 GTX 289.99 set
MD650104 1971-74 Road Runner 289.99 set
MD650104 1971-74 Satellite hrdtp 289.99 set

E-Body

MD650105 1970-74 Challenger 289.99 set
MD650105 1970-74 Barracuda 289.99 set

Universal Power Window Kit

MD650106 1960-76 front/rear 129.99 set

GM Style Switches

(1) 2-Button Switch, (1) 1-Button Switch, & Harness
SWK100 134.99 set

(1) 4-Button Switch, (3) 1-Button Switches, & Harness
SWK101 209.99 set

Billot Style Switches

(1) 2-Button Switch, (1) 1-Button Switch, & Harness
SWK102 154.99 set

(1) 4-Button Switch, (3) 1-Button Switches, & Harness
SWK103 379.99 set

Body Repair Panels



AUTHENTIC RESTORATION

MM1147



MM1145A

1968-74 Roof Panel Skins

RESTORER'S CHOICE

Reproduction roof panel skins for various 1968-74 models. Each panel is EDP coated to prevent rust and features correct contours. Your choice of our Restorer's Choice panel, officially licensed by Mopar, manufactured in OE-gauge steel featuring all original contours and details or our standard replacement for the car builder on a budget.

Note: Shipped truck freight.

Restorer's Choice

B-Body			
MM1147	1968-70	B-Body - except Charger	679.99 ea
MM1146	1968-70	Charger	679.99 ea
E-Body			
MM1144B	1970-74	Barracuda	614.99 ea
MM1145B	1970-74	Challenger	614.99 ea

Standard Replacement

E-Body			
MM1144A	1970-74	Barracuda	479.99 ea
MM1145A	1970-74	Challenger	479.99 ea



1968-70 Charger Rear Roof Bow

Reproduction inner rear roof bow for 1968-70 Charger models. This EDP coated reproduction is commonly needed when replacing the roof skin.

Note: Shipped overseas.

MM1148	1968-70		104.99 ea
--------	---------	--	-----------



1968-74 Rear Pillar Drip Rail Supports

Reproduction stamped steel rear drip rail supports for 1968-74 models. Installs on the roof panel's rear pillar section and extends down vertically between the roof panel and trunk.

B-Body			
MM1149	1968-70	B-Body	189.99 pr
E-Body			
MM1150	1970-74	Barracuda	189.99 set
MM1151	1970-74	Challenger	189.99 pr



1968-70 Charger Sail Repair Panels

These replacement outer sail panels for 1968-70 Charger models feature correct contours. Made in the USA.

MB1878	1968-70	LH	114.99 ea
MB1879	1968-70	RH	114.99 ea



AUTHENTIC RESTORATION

1970-76 A-Body Coupe Rear Lower Window Frame

Reproduction of the rear lower back glass window frame for 1970-76 2 door coupe models. This stamped steel piece features correct contours and is EDP coated for rust prevention.

MM1934	1970-76	2 door coupe models	109.99 ea
--------	---------	---------------------	-----------



AUTHENTIC RESTORATION

1970-76 Duster Rear Lower Window Frame

Replacement back glass lower frame for 1970-76 Duster models. This EDP coated piece is manufactured from heavy gauge steel and features correct contours.

MM1903	1970-76		44.99 ea
--------	---------	--	----------



AUTHENTIC RESTORATION

1968-70 Charger Rear Lower Window Frame

Replacement rear window frame for 1968-70 Charger models. This is a commonly rusted area and it is best to replace this frame when also replacing the rear package tray or the rear deck filler panel.

MM1577	1968-70		134.99 ea
--------	---------	--	-----------



AUTHENTIC RESTORATION

1968-70 B-Body Lower Rear Window Frame

Reproduction rear lower window frame for 1968-70 B-Body models except Charger. Attaches to the roof inner structure and supports the rear window.

MM2101	1968-70	B-Body except Charger	134.99 ea
--------	---------	-----------------------	-----------

New!



AUTHENTIC RESTORATION

1968-70 B-Body Back Glass Lower Fillers

Reproduction back glass lower corner fillers for all 1968-70 B-Body models. These pieces are welded to the inner lower corners of the back glass frame. Come EDP coated for rust prevention.

MB280963	1968-70	LH	32.99 ea
MB280964	1968-70	RH	32.99 ea



MB184566

1964-76 Drip Rail Foam Strips

Replacement drip rail foam strips for various 1964-76 A, B and E-Body models. These pieces are laser cut to the exact shape and will replace your deteriorated factory originals correctly. Made in USA.

A-Body			
MA820167	1966-76	all models	11.99 set
B-Body			
MB184564	1964-65	all models	11.99 set
MB184565	1966-67	Coronet	11.99 set
MB184566	1968-70	Coronet	22.99 set
MB184565	1966-70	Charger	11.99 set
MB184565	1966-67	Belvedere	11.99 set
MB184566	1968-70	Road Runner	22.99 set
MB184566	1968-70	Sport Satellite	22.99 set
MB184566	1968-70	GTX	22.99 set
MD600324	1971-74	all models	22.99 set
E-Body			
MD600324	1970-74	all	22.99 set

Body Repair Panels



MM1099

1968-74 Rear Shelf Panel

Reproduction rear shelf panel for various 1968-74 models. Seat shelf panels solve the rust problem and feature the correctly punched and formed holes for the speakers to mount.

Note: Shipped double oversize.

B-Body		Charger	363
MM1101	1968-70	Charger	339.99 ea
MM2100	1968-70	B-Body except Charger	344.99 ea
E-Body			
MM1099	1970-74	Barracuda	359.99 set
MM1100	1970-74	Challenger	359.99 set

New!



MM1578

MM1579

MM1580

MM1581

Restorer's Choice

1967-76 Deck Filler Patch Panels

Stamped steel repair panels for 1968-70 B-Body (except Charger) and 1967-76 A-Body models. These can be welded in to repair the rusted lower back glass corners. The outer panels are seen from the outside of the vehicle and the inner panels are reinforcements for the uppers. Available in your choice of our Restorer's Choice pieces, officially licensed by Mopar, manufactured in OE-gauge steel featuring all original contours and details or our standard replacement for the car builder on a budget. Come finished in black EDP coating to prevent rust.

Restorer's Choice

A-Body				
MAR22047	1967-76	LH	inner - Dart	32.99 ea
MAR22048	1967-76	RH	inner - Dart	32.99 ea
MAR22047	1972-76	LH	inner - Scamp	32.99 ea
MAR22048	1972-76	RH	inner - Scamp	32.99 ea
B-Body				
MM1578	1968-70	LH	outer	89.99 ea
MM1579	1968-70	RH	outer	89.99 ea
MM1580	1968-70	LH	inner	29.99 ea
MM1581	1968-70	RH	inner	29.99 ea
MM1582	1968-70	LH/RH	inner & outer 4-piece set	194.99 set

Standard Replacement

B-Body				
MM1580A	1968-70	LH	inner	23.99 ea
MM1581A	1968-70	RH	inner	23.99 ea

New!

1968-70 Package Panel Ext.

Reproduction package tray panel extensions for all 1968-70 Dodge and Plymouth B-Body models.

These pieces are welded to each side of the package tray and feature correct pre-cut openings and come EDP coated for rust prevention. Will not fit Charger models.

MB280969

MB280969 1968-70 LH39.99 ea

MB280970 1968-70 RH39.99 ea

MB280970 1968-70 RH39.99 ea

MB280970 1968-70 RH39.99 ea



1968-70 Deck Filler Plenum

Reproduction rear deck filler plenum for 1968-70 Charger models. This is a quality stamped steel EDP coated replacement panel that is welded underneath the rear deck filler panel.

MM1576 1968-70 224.99 ea

Authentic Restoration



MM1772

MM1614

MM1615

1968-74 Rear Shelf Support

Replacement rear package tray supports for 1968-74 models. This stamped steel EDP coated brace is welded underneath the rear shelf panel for additional support. E-Body models require one brace, B-Body models require two per vehicle.

MM1772	1968-70	B-Body - except Charger	29.99 ea
MM1614	1970-74	Barracuda	29.99 ea
MM1615	1970-74	Challenger	29.99 ea

Authentic Restoration



1968-70 Charger Interior Trim Retainer

Replacement stamped steel interior trim retainer for 1968-70 Charger models. This retainer is welded to the edge of the rear shelf panel and once installed, it acts as an anchor for the interior molding.

MM1053	1968-70		64.99 ea
--------	---------	--	----------

New!



MM1155B



MM1152A

Restorer's Choice

1967-74 Rear Outer Filler Panel

Factory-style replacement upper rear outer body panel (also called deck filler panel) for 1967-76 A-Body, 1968-74 B-Body, and 1970-74 E-Body models. Often rusted out, this panel installs between the rear window or top well area and the trunk lid. Your choice of our Restorer's Choice panel, officially licensed by Mopar, manufactured in OE-gauge steel featuring all original contours and details or our standard replacement for the car builder on a budget. Either choice comes finished in black EDP coating to prevent rust.

Note: Shipped oversize.

Restorer's Choice

A-Body				
MAR22049	1967-76	Dart		169.99 ea
MAR22049	1972-76	Scamp		169.99 ea
MM1931	1967-69	Barracuda coupe		169.99 ea
B-Body				
MM1152B	1968-70	B-Body coupe - except Charger		154.99 ea
MM1154	1968-70	Charger		274.99 ea
MM1153	1971-74	B-Body		179.99 ea
E-Body				
MM1155B	1970-74	Barracuda		164.99 ea
MM1156B	1970-74	Challenger		164.99 ea

Standard Replacement

B-Body				
MM1152A	1968-70	B-Body coupe - except Charger		119.99 ea
MM1155A	1970-74	Barracuda		129.99 ea
MM1156A	1970-74	Challenger		129.99 ea

Quarter Panel Repair



MM836038

1970-74 Challenger Quarter Panel and Door Frame

Reproduction of the quarter panel and door frame assembly for 1970-74 Challenger models. These unique pieces will replace the frame work around the doors, across the roof line and down the quarter panel to the rear wheel well. Includes the front kick panel area as well as the inner rear quarter area. Outer rocker panels are also included. Finished in a silver weld through primer for rust prevention, welding is required for installation.

Note: Shipped truck freight. Special order, must be pre-paid.
MM836038 1970-74 LH 3079.99 ea
MM836039 1970-74 RH 3079.99 ea



MM1312



MM1317



1967-76 A-Body Quarter Panels

Reproduction quarter panels for various 1967-76 A-Body models. This panel is our Restorer's Choice panel, manufactured in OE-gauge steel featuring all original contours and details. These quarter panels do not feature the door jamb area since these were not originally made that way by Chrysler. Comes finished in semi-flat black EDI coating to prevent rust and are ready to prep and paint to your desired color.

Important: Quarter panels are manufactured to factory specifications and as such they do not include the door jamb area.
Note: Shipped truck freight.

Part Number	Year	Side	Price
MM1307	1967	LH, Dart	509.99 ea
MM1308	1967	RH, Dart	509.99 ea
MM1309	1968	LH, Dart	509.99 ea
MM1310	1968	RH, Dart	509.99 ea
MM1311	1969	LH, Dart	509.99 ea
MM1312	1969	RH, Dart	509.99 ea
MM8336	1967	LH, Barracuda fastback	599.99 ea
MM8337	1967	RH, Barracuda fastback	599.99 ea
MM8338	1968	LH, Barracuda fastback	599.99 ea
MM8339	1968	RH, Barracuda fastback	599.99 ea
MM7905	1969	LH, Barracuda fastback	599.99 ea
MM7906	1969	RH, Barracuda fastback	599.99 ea
MM1313	1970-71	LH, Dart	509.99 ea
MM1314	1970-71	RH, Dart	509.99 ea
MM1315	1972-76	LH, Dart	509.99 ea
MM1316	1972-76	RH, Dart	509.99 ea
MM1317	1970-71	LH, Duster/Demon	494.99 ea
MM1318	1970-71	RH, Duster/Demon	494.99 ea
MM1319	1972-76	LH, Duster/Demon/Dart Sport	494.99 ea
MM1320	1972-76	RH, Duster/Demon/Dart Sport	494.99 ea



MM1324B



MM1324A

1968-72 B-Body Quarter Panels

Reproduction quarter panels for various 1967-76 B-Body models. Your choice of our Restorer's Choice panel, officially licensed by Mopar, manufactured in OE-gauge steel featuring all original contours and details of our standard replacement for the car builder on a budget. Each panel features pre-cut fuel and side marker openings when applicable. These quarter panels do not feature the door jamb area since these were not originally made that way by Chrysler. Comes finished in semi-flat black EDI coating.

Important: Quarter panels are manufactured to factory specifications and as such they do not include the door jamb area.
Note: Shipped truck freight.

Restorer's Choice

Part Number	Year	Model	Price
MM1321B	1968	LH, Charger	599.99 ea
MM1322B	1968	RH, Charger	599.99 ea
MM1331	1968	LH, Coronet, Super Bee	779.99 ea
MM1332	1968	RH, Coronet, Super Bee	779.99 ea
MM1323B	1969	LH, Charger	599.99 ea
MM1324B	1969	RH, Charger	599.99 ea
MM1333	1969	LH, Coronet, Super Bee	579.99 ea
MM1334	1969	RH, Coronet, Super Bee	579.99 ea
MM1325B	1970	LH, Charger	599.99 ea
MM1326B	1970	RH, Charger	599.99 ea
MM1327	1971	LH, Charger	559.99 ea
MM1328	1971	RH, Charger	559.99 ea
MM1335B	1968	LH, all	599.99 ea
MM1336B	1968	RH, all	599.99 ea
MM1337B	1969	LH, all	599.99 ea
MM1338B	1969	RH, all	599.99 ea
MM1339	1970	LH, all	599.99 ea
MM1340	1970	RH, all	599.99 ea
MM1341B	1971	LH, all	639.99 ea
MM1342B	1971	RH, all	639.99 ea
MM1343B	1972	LH, all	639.99 ea
MM1344B	1972	RH, all	639.99 ea

Standard Replacement

Part Number	Year	Model	Price
MM1321A	1968	LH, Charger	499.99 ea
MM1322A	1968	RH, Charger	499.99 ea
MM1323A	1969	LH, Charger	529.99 ea
MM1324A	1969	RH, Charger	529.99 ea
MM1325A	1970	LH, Charger	529.99 ea
MM1326A	1970	RH, Charger	529.99 ea
MM1335A	1968	LH, all	499.99 ea
MM1336A	1968	RH, all	499.99 ea
MM1337A	1969	LH, all	499.99 ea
MM1338A	1969	RH, all	499.99 ea
MM1341A	1971	LH, all	499.99 ea
MM1342A	1971	RH, all	499.99 ea
MM1343A	1972	LH, all	499.99 ea
MM1344A	1972	RH, all	499.99 ea

88 BODY COMPONENTS

Quarter Panel Repair



MM1345B



MM1350B



MM1345A



MM1350A



1970-74 E-Body Quarter Panels

Replacement quarter panels for various 1970-74 E-Body models. Your choice of our Restorer's Choice panel, officially licensed by Mopar, manufactured in OE-gauge steel featuring all original contours and details or our standard replacement for the car builder on a budget. Each panel features pre-cut fuel and side marker openings when applicable. These quarter panels do not feature the door jamb area since these were not originally made that way by Chrysler. Comes finished in semi-flat black EDP coating.

Important: Quarter panels are manufactured to factory specifications and as such they do not include the door jamb area.

Note: Skipped track freight.

Restorer's Choice

Barracuda			
MM1345B	1970-71	LH	599.99 ea
MM1346B	1970-71	RH	599.99 ea
MM1347B	1972-74	LH	599.99 ea
MM1348B	1972-74	RH	599.99 ea

Challenger

MM1349B	1970-71	LH	599.99 ea
MM1350B	1970-71	RH	599.99 ea
MM1351B	1972-74	RH	599.99 ea
MM1352B	1972-74	RH	599.99 ea

Standard Replacement

Barracuda			
MM1345A	1970-71	LH	479.99 ea
MM1346A	1970-71	RH	479.99 ea
MM1347A	1972-74	LH	479.99 ea
MM1348A	1972-74	RH	479.99 ea

Challenger

MM1349A	1970-71	LH	479.99 ea
MM1350A	1970-71	RH	479.99 ea
MM1351A	1972-74	RH	479.99 ea
MM1352A	1972-74	RH	479.99 ea



MM1171B



1967-76 Quarter Panel Skins

Replacement quarter panel skin for various 1967-76 models. Your choice of our Restorer's Choice panel, officially licensed by Mopar, manufactured in OE-gauge steel featuring all original contours and details or our standard replacement for the car builder on a budget. Each panel features pre-cut fuel and side marker openings when applicable. This partial skin extends to the top crease of the original quarter panel. Comes finished in semi-flat black EDP coating.

Note: Skipped track freight.

Restorer's Choice

A-Body			
MM1171B	1967	LH, Dart	274.99 ea
MM1172B	1967	RH, Dart	274.99 ea
MM1173	1968	LH, Dart	274.99 ea
MM1174	1968	RH, Dart	274.99 ea
MM1175B	1969	LH, Dart	299.99 ea
MM1176B	1969	RH, Dart	299.99 ea
MM1177B	1970-71	LH, Dart	299.99 ea
MM1178B	1970-71	RH, Dart	299.99 ea
MM1179	1972-76	LH, Dart	274.99 ea
MM1180	1972-76	RH, Dart	274.99 ea
MM1181B	1970-71	LH, Duster/Demon	299.99 ea
MM1182B	1970-71	RH, Duster/Demon	299.99 ea
MM1183B	1972-76	LH, Duster/Demon	299.99 ea
MM1184B	1972-76	RH, Duster/Demon	299.99 ea
MM1185B	1972-76	LH, Dart Sport	299.99 ea
MM1186B	1972-76	RH, Dart Sport	299.99 ea

Dodge B-Body

MM1185B	1968	LH, Charger	369.99 ea
MM1186B	1968	RH, Charger	369.99 ea
MM1187B	1969	LH, Charger	369.99 ea
MM1188B	1969	RH, Charger	369.99 ea
MM1189B	1970	LH, Charger	369.99 ea
MM1190B	1970	RH, Charger	369.99 ea
MM1207	1971	LH, Charger	339.99 ea
MM1208	1971	RH, Charger	339.99 ea
MM1209	1972	LH, Charger	339.99 ea
MM1210	1972	RH, Charger	339.99 ea
MM1191B	1968	LH, Coronet	369.99 ea
MM1192B	1968	RH, Coronet	369.99 ea
MM1191B	1968	LH, Super Bee	369.99 ea
MM1192B	1968	RH, Super Bee	369.99 ea
MM1193B	1969	LH, Coronet	369.99 ea
MM1194B	1969	RH, Coronet	369.99 ea
MM1194A	1969	LH, Super Bee	369.99 ea
MM1194A	1969	RH, Super Bee	369.99 ea

Plymouth B-Body

MM1195B	1968	LH, all	369.99 ea
MM1196B	1968	RH, all	369.99 ea
MM1197B	1969	LH, all	369.99 ea
MM1198B	1969	RH, all	369.99 ea
MM1199B	1970	LH, all	369.99 ea
MM1200B	1970	RH, all	369.99 ea
MM1201B	1971	LH, all	369.99 ea
MM1202B	1971	RH, all	369.99 ea
MM1203B	1972	LH, all	369.99 ea
MM1204B	1972	RH, all	369.99 ea

E-Body

MM1219B	1970-71	LH, Barracuda	299.99 ea
MM1220B	1970-71	RH, Barracuda	299.99 ea
MM1221B	1972-74	LH, Barracuda	274.99 ea
MM1222B	1972-74	RH, Barracuda	274.99 ea
MM1223B	1970-71	LH, Challenger	299.99 ea
MM1224B	1970-71	RH, Challenger	299.99 ea
MM1225B	1972-74	LH, Challenger	299.99 ea
MM1226B	1972-74	RH, Challenger	299.99 ea

Standard Replacement

A-Body			
MM1213	1967	LH, Barracuda	209.99 ea
MM1214	1967	RH, Barracuda	209.99 ea
MM1215	1968	LH, Barracuda	209.99 ea
MM1216	1968	RH, Barracuda	209.99 ea
MM1217	1969	LH, Barracuda	209.99 ea
MM1218	1969	RH, Barracuda	209.99 ea
MM1171A	1967	LH, Dart	169.99 ea
MM1172A	1967	RH, Dart	169.99 ea
MM1175A	1969	LH, Dart	209.99 ea
MM1176A	1969	RH, Dart	209.99 ea
MM1177A	1970-71	LH, Dart	209.99 ea
MM1178A	1970-71	RH, Dart	209.99 ea
MM1181A	1970-71	LH, Duster/Demon	209.99 ea
MM1182A	1970-71	RH, Duster/Demon	209.99 ea
MM1183A	1972-76	LH, Duster/Demon	164.99 ea
MM1184A	1972-76	RH, Duster/Demon	164.99 ea
MM1183A	1972-76	LH, Dart Sport	164.99 ea
MM1184A	1972-76	RH, Dart Sport	164.99 ea

Dodge B-Body

MM1185A	1968	LH, Charger	259.99 ea
MM1186A	1968	RH, Charger	259.99 ea
MM1187A	1969	LH, Charger	259.99 ea
MM1188A	1969	RH, Charger	259.99 ea
MM1189A	1970	LH, Charger	259.99 ea
MM1190A	1970	RH, Charger	259.99 ea
MM1211	1973-74	LH, Charger	451.99 ea
MM1212	1973-74	RH, Charger	451.99 ea
MM1191A	1968	LH, Coronet	209.99 ea
MM1192A	1968	RH, Coronet	209.99 ea
MM1191A	1968	LH, Super Bee	209.99 ea
MM1192A	1968	RH, Super Bee	209.99 ea
MM1193A	1969	LH, Coronet	209.99 ea
MM1194A	1969	RH, Coronet	209.99 ea
MM1193A	1969	LH, Super Bee	209.99 ea
MM1194A	1969	RH, Super Bee	209.99 ea
MM1205	1970	LH, Coronet	169.99 ea
MM1206	1970	RH, Coronet	169.99 ea
MM1205	1970	LH, Super Bee	169.99 ea
MM1206	1970	RH, Super Bee	169.99 ea

Plymouth B-Body

MM1195A	1968	LH, all	209.99 ea
MM1196A	1968	RH, all	209.99 ea
MM1197A	1969	LH, all	189.99 ea
MM1198A	1969	RH, all	209.99 ea
MM1199A	1970	LH, all	209.99 ea
MM1200A	1970	RH, all	209.99 ea
MM1201A	1971	LH, all	289.99 ea
MM1202A	1971	RH, all	289.99 ea
MM1203A	1972	LH, all	289.99 ea
MM1204A	1972	RH, all	289.99 ea

E-Body

MM1219A	1970-71	LH, Barracuda	179.99 ea
MM1220A	1970-71	RH, Barracuda	179.99 ea
MM1221A	1972-74	LH, Barracuda	144.99 ea
MM1222A	1972-74	RH, Barracuda	144.99 ea
MM1223A	1970-71	LH, Challenger	204.99 ea
MM1224A	1970-71	RH, Challenger	204.99 ea
MM1225A	1972-74	LH, Challenger	144.99 ea
MM1226A	1972-74	RH, Challenger	144.99 ea

Quarter Panel Repair

New!



MP41253

1963-66 A-Body Quarter Patch Panels

Replacement quarter patch panels for various 1963-66 models. Each panel features correct gauge sheet metal and original contours.

1963-66 Dart

MP41245	1963-66	LH	wheel arch 37" x 15-1/2"	159.99	ea
MP41246	1963-66	RH	wheel arch 37" x 15-1/2"	159.99	ea
MP41247	1963-66	LH	rear lower 34-1/2" x 14-1/2"	142.99	ea
MP41248	1963-66	RH	rear lower 34-1/2" x 14-1/2"	142.99	ea

1963-66 Valiant/Barracuda

MP41249	1963-65	LH	wheel arch 40" x 19-1/2"	199.99	ea
MP41250	1963-65	RH	wheel arch 40" x 19-1/2"	199.99	ea
MP41251	1963-65	LH	rear lower 30" x 14"	171.99	ea
MP41252	1963-65	RH	rear lower 30" x 14"	171.99	ea
MP41253	1966	LH	lower half 66" x 16"	299.99	ea
MP41254	1966	RH	lower half 66" x 16"	299.99	ea



MB1882

1968-70 Charger Rear Quarter Panel Half

Replacement rear quarter panel half for 1968-70 Dodge Charger models. These panels will replace the commonly rusted and damaged rear section of the quarter panel. Each panel features correct contours, comes EDP coated, and measures approximately 25" by 52.5".

Important: Does not feature side marker cut-out.

Note: Shipped double oversize.

MB1882	1968-70	LH	169.99	ea
MB1883	1968-70	RH	169.99	ea



MM8217

MM8218

1968-74 B & E-Body Lower Front Quarter Patch Panels

These patch panels will replace the lower front section of the rear quarter panel. Each panel features correct contours, correct gauge sheet metal and is ready to prep and paint.

Note: Shipped oversize.

B-Body

MM8217	1968-70	LH	Charger - 32"H x 24"W	114.99	ea
MM8218	1968-70	RH	Charger - 32"H x 24"W	114.99	ea
MM8220	1968-70	LH	Road Runner - 15"H x 22"W	114.99	ea
MM8219	1968-70	RH	Road Runner - 15"H x 22"W	114.99	ea

E-Body

MM8211	1970-74	LH	Barracuda - 17-1/4"H x 12-1/2"W	74.99	ea
MM8212	1970-74	RH	Barracuda - 17-1/4"H x 12-1/2"W	74.99	ea
MM8213	1970-74	LH	Challenger - 18"H x 13-1/4"W	74.99	ea
MM8214	1970-74	RH	Challenger - 18"H x 13-1/4"W	74.99	ea



MM8215

1966-67 Coronet Lower Rear Quarter Patch Panels

These patch panels will replace the lower rear section of the rear quarter panel. Each panel features correct contours, and correct gauge sheet metal.

Note: Shipped oversize.

MM8215	1966-67	LH	14"H	114.99	ea
MM8216	1966-67	RH	14"H	114.99	ea



1968-70 Charger Quarter End Cap

These replacement quarter panel end caps for 1968-70 Charger models are manufactured from pot metal, feature correct contours, and include mounting gaskets.

MB1730	1968-70	154.99	pr
--------	---------	-------	--------	----



MM1482A

1971-72 B-Body Lower Rear Quarter Patch Panels

Factory style replacement lower rear quarter patch panel. For 1971-72 Plymouth B-Body models. Each panel features pre-cut side marker openings. Comes finished with black EDP coating to prevent rust and is ready to prep and paint to your desired color.

Note: Shipped oversize.

MM1481A	1971	LH	154.99	ea
MM1482A	1971	RH	154.99	ea
MM1483A	1972	LH	154.99	ea
MM1484A	1972	RH	154.99	ea

New!



1969-70 Coronet Quarter Scoop Hardware

Reproduction quarter scoop mounting hardware for 1969-70 Dodge Coronet models. Every set includes the correct studs, bell tower nuts and sealing washers. One set required per vehicle.

MN3066	1969-70	51.99	set
--------	---------	-------	-------	-----

Quarter Panel Repair



1971-72 Plymouth B-Body Quarter Patch Panels

These patch panels will replace the commonly rusted and damaged sections of the rear quarter panel. Each panel features correct contours and come EDP coated for rust prevention.

Note: *Shipped oversize.

Front Patch					
MB1884	1971-72	LH	23" long x 14" tall	159.99 ea
MB1885	1971-72	RH	23" long x 14" tall	159.99 ea

Center Patch					
MB1886*	1971-72	LH	45" long x 15" tall	159.99 ea
MB1887*	1971-72	RH	45" long x 15" tall	159.99 ea

Rear Patch					
MB1888	1971-72	LH	30" long x 12" tall	149.99 ea
MB1889	1971-72	RH	30" long x 12" tall	149.99 ea



1971-72 Charger Quarter Panel Reinforcement

Inner quarter panel reinforcements for 1971-72 Charger models. This panel is manufactured from heavy gauge steel and is a must when replacing quarter panels.

MM1778	1971-72	LH	44.99 ea
MM1779	1971-72	RH	44.99 ea

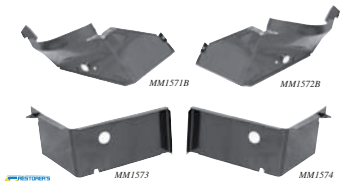

1971-72 Plymouth B-Body Quarter Panel Inner Reinforcement

Factory-style replacement panels for 1971-72 Plymouth B-Body models. These panels are often rusted and should also be considered for replacement whenever replacing a quarter panel. Your choice of a Mopar officially licensed "Restorer's Choice" panel, manufactured in OE-gauge steel featuring all original contours and details or our standard replacement for the car builder on a budget. Comes finished in black EDP coating to prevent rust.

Restorer's Choice					
MM1571B	1971-72	LH	inner reinforcement panel	44.99 ea
MM1572B	1971-72	RH	inner reinforcement panel	44.99 ea
MM1573	1971-72	LH	inner reinforcement panel extension	44.99 ea
MM1574	1971-72	RH	inner reinforcement panel extension	44.99 ea

Standard Replacement					
MM1571A	1971-72	LH	inner reinforcement panel	34.99 ea
MM1572A	1971-72	RH	inner reinforcement panel	34.99 ea

1967-76 Outer Wheelhouse Panels



Reproduction outer wheelhouse panels for various 1967-76 models.

This is the outer section of the wheelhouse assembly which installs between the quarter panel and inner wheelhouse panel. These panels mate with the inner wheelhouse, forming the complete enclosure.

Your choice of our Restorer's Choice panel, officially licensed by Mopar, manufactured in OE-gauge steel featuring all original contours and details or our standard replacement for the car builder on a budget. Comes finished in black EDP coating to prevent rust.

Note: Shipped double oversize.



Restorer's Choice					
A-Body					
MM1396	1967-69	LH	Barracuda	124.99 ea
MM1397	1967-69	RH	Barracuda	124.99 ea
MM2396	1967-76	LH	Dart, Valiant	124.99 ea
MM2397	1967-76	RH	Dart, Valiant	124.99 ea
MM1396	1970-76	LH	Demon, Dart Sport, Duster	124.99 ea
MM1397	1970-76	RH	Demon, Dart Sport, Duster	124.99 ea
B-Body					
MM1398B	1968-70	LH	Coronet, Charger, Super Bee	139.99 ea
MM1399B	1968-70	RH	Coronet, Charger, Super Bee	139.99 ea
MM1402B	1968-70	LH	all Plymouth	134.99 ea
MM1403B	1968-70	RH	all Plymouth	134.99 ea
MM1400	1971	LH	Charger	139.99 ea
MM1401	1971	RH	Charger	139.99 ea
MM1404B	1971-74	LH	all Plymouth	134.99 ea
MM1405B	1971-74	RH	all Plymouth	134.99 ea

Standard Replacement					
B-Body					
MM1398A	1968-70	LH	Coronet, Charger, Super Bee	109.99 ea
MM1399A	1968-70	RH	Coronet, Charger, Super Bee	109.99 ea
MM1402A	1968-70	LH	all Plymouth	109.99 ea
MM1403A	1968-70	RH	all Plymouth	109.99 ea
MM1404A	1971-74	LH	all Plymouth	109.99 ea
MM1405A	1971-74	RH	all Plymouth	109.99 ea
E-Body					
MM1406	1970-74	LH	Barracuda	99.99 ea
MM1407	1970-74	RH	Barracuda	99.99 ea
MM1408	1970-74	LH	Challenger	99.99 ea
MM1409	1970-74	RH	Challenger	99.99 ea

1966-76 Inner Wheelhouse Panels



Replacement inner wheelhouse panels for various 1966-76 Mopar models. This is the inner section of the wheelhouse assembly which installs between the trunk area and outer wheelhouse panel. This panel mates with the outer wheelhouse forming the complete enclosure.

Your choice of our Restorer's Choice panel, officially licensed by Mopar, manufactured in OE-gauge steel featuring all original contours and details or our standard replacement for the car builder on a budget. Comes finished in black EDP coating to prevent rust.

Note: Shipped double oversize.



Restorer's Choice					
A-Body					
MM1367	1967-76	LH	134.99 ea	
MM1368	1967-76	RH	134.99 ea	
B-Body					
MM1369B	1966-70	LH	154.99 ea	
MM1370B	1966-70	RH	154.99 ea	
MM1371B	1971-74	LH	154.99 ea	
MM1372B	1971-74	RH	154.99 ea	
E-Body					
MM1373B	1970-74	LH	134.99 ea	
MM1374B	1970-74	RH	134.99 ea	
Standard Replacement					
MM1369A	1966-70	LH	124.99 ea	
MM1370A	1966-70	RH	124.99 ea	
MM1371A	1971-74	LH	94.99 ea	
MM1372A	1971-74	RH	94.99 ea	
E-Body					
MM1373A	1970-74	LH	99.99 ea	
MM1374A	1970-74	RH	99.99 ea	

A-Body Vinyl Tops

Replacement vinyl tops manufactured to original specifications with the correct 100% cotton drill backing that offers trouble free installation and long term durability. All seams are double stitched and dielectrically heat-sealed ensuring accurate deck width

and seam durability. Each top is individually patterned for your specific year and model for a perfect fit and an original appearance! Made in USA.
Note: The measurement given is for the center-deck on vehicles with seams.

Legendary
AUTO INTERIORS LTD.



MA2175



MA2158



Boar Grain Vinyl Top Material



black



white



pearl white



antique green



tan

Levant Grain Vinyl Top Material



black



white



- Safely removes tough soils and stains!
- UV protectant included!
- Protection lasts weeks, not days!
- Maintains original luster of vinyl tops!
- Buy the kit and save!



OER® Top Secret Vinyl Top Care

OER® Top Secret is a complete system for the care of vinyl tops. It consists of a heavy duty cleaner that safely removes the toughest soils and stains with an exclusive formula that will not harm automotive finishes. Included in the vinyl kit is our vinyl UV protectant and applicator to shield your vinyl top against damaging UV rays, a 100% dry to the touch formula that will last weeks, not just days.

OER Top Secret Kit

K89456 cleaner, protectant, applicator 22.99 kit

OER Top Secret Components

K89458 16 oz. bottle top cleaner..... 9.99 ea
K89468 16 oz. bottle vinyl protectant..... 10.99 ea
K89460 applicator..... 3.99 ea

Item #	Year	Width	Grain	Color	Body Style	Notes	Price
Barracuda							
MA2149	1967-69	34"	Boar	black	notchback	211.99 ea
MA2150	1967-69	34"	Levant	black	notchback	211.99 ea
MA2151	1967-69	34"	Boar	white	notchback	211.99 ea
MA2152	1967-69	34"	Boar	tan	notchback	281.99 ea
MA2153	1968-69	34"	Boar	antique green	notchback	239.99 ea
MA2154	1968-69	34"	Boar	pearl white	notchback	239.99 ea
MA2155	1969	34"	Boar	black	fastback	seamless	94.99 ea
MA2156	1969	34"	Boar	tan	fastback	seamless	144.99 ea
MA2157	1967	41"	Levant	black	notchback	211.99 ea
MA2158	1968-69	41"	Boar	black	notchback	211.99 ea
MA2159	1968-69	41"	Boar	white	notchback	211.99 ea
MA2160	1968-69	41"	Boar	antique green	notchback	242.99 ea
MA2161	1968-69	41"	Boar	pearl white	notchback	242.99 ea
MA2162	1968-69	41"	Boar	black	notchback	281.99 ea
MA2163	1969	42"	Boar	black	fastback	211.99 ea
MA2164	1969	42"	Boar	antique green	fastback	242.99 ea
MA2165	1969	42"	Boar	pearl white	fastback	242.99 ea
MA2166	1969	42"	Boar	tan	fastback	281.99 ea
Dart/Scamp							
MA2167	1967-76	38"	Boar	black	2 door hardtop	211.99 ea
MA2168	1967-76	38"	Boar	white	2 door hardtop	211.99 ea
MA2169	1967-76	38"	Boar	tan	2 door hardtop	281.99 ea
MA2170	1967	38"	Levant	black	2 door hardtop	211.99 ea
MA2171	1967	38"	Levant	white	2 door hardtop	211.99 ea
MA2172	1968-69	38"	Boar	pearl white	2 door hardtop	239.99 ea
MA2173	1968-70	38"	Boar	antique green	2 door hardtop	239.99 ea
MA2174	1971-76	38"	Boar	green	2 door hardtop	281.99 ea
MA2175	1967-76	43"	Boar	black	2 door hardtop	211.99 ea
MA2176	1967-76	43"	Boar	white	2 door hardtop	211.99 ea
MA2177	1967-76	43"	Boar	tan	2 door hardtop	281.99 ea
MA2178	1968-69	43"	Boar	pearl white	2 door hardtop	239.99 ea
MA2179	1968-70	43"	Boar	black	2 door hardtop	239.99 ea
MA2180	1971-73	43"	Boar	green	2 door hardtop	281.99 ea
Dart Sport/Demon/Duster							
MA2181	1970-76	36-1/2"	Boar	black	2 door coupe	full top	211.99 ea
MA2182	1970-76	36-1/2"	Boar	white	2 door coupe	full top	211.99 ea
MA2183	1970-76	36-1/2"	Boar	green	2 door coupe	full top	281.99 ea
MA2184	1970-76	41"	Boar	black	2 door coupe	full top	211.99 ea
MA2185	1970-76	41"	Boar	white	2 door coupe	full top	211.99 ea
MA2186	1970-76	41"	Boar	green	2 door coupe	full top	281.99 ea
MA2187	1972-76	39-1/2"	Boar	black	2 door coupe	canopy style	211.99 ea
MA2188	1972-76	39-1/2"	Boar	white	2 door coupe	canopy style	211.99 ea
MA2189	1972-76	39-1/2"	Boar	green	2 door coupe	canopy style	281.99 ea
MA2190	1972-76	39-1/2"	Boar	black	2 door coupe	seamless	211.99 ea
MA2191	1972-76	39-1/2"	Boar	white	2 door coupe	seamless	211.99 ea
Dart Custom 4-Door							
MA2192	1972	39"	Boar	black	4 door sedan	211.99 ea
MA2193	1972	39"	Boar	white	4 door sedan	211.99 ea
MA2194	1972	39"	Boar	green	4 door sedan	281.99 ea

B and E-Body Vinyl Tops

Replacement vinyl tops manufactured to original specifications with the correct 100% cotton drill backing that offers trouble free installation and long term durability. All seams are double stitched and dielectrically heat-sealed ensuring accurate deck width

and seam durability. Each top is individually patterned for your specific year and model for a perfect fit and an original appearance! Made in USA.
Note: The measurement given is for the center deck on vehicles with seams.



Legendary
AUTO INTERIORS LTD.

Made in USA

Boar Grain Vinyl Top Material



Levant Grain Vinyl Top Material

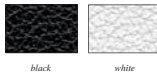

Item #	Year	Width	Grain	Color	Style	Price
B-Body Except Charger						
MB2264	1966-67	41"	Boar	black	211.99 ea
MB2265	1966-67	41"	Boar	white	211.99 ea
MB2266	1966-67	41"	Levant	black	211.99 ea
MB2267	1966-67	41"	Levant	white	211.99 ea
MB2268	1968-69	42-1/2"	Boar	black	211.99 ea
MB2269	1968-69	42-1/2"	Boar	white	211.99 ea
MB2270	1968-69	42-1/2"	Boar	antique green	211.99 ea
MB2271	1968-69	42-1/2"	Boar	pearl white	242.99 ea
MB2272	1968-69	42-1/2"	Boar	tan	281.99 ea
MB2273	1970	41"	Boar	black	242.99 ea
MB2274	1970	41"	Boar	white	211.99 ea
MB2275	1970	41"	Boar	antique green	242.99 ea
B-Body Charger						
MB2276	1967	42-1/2"	Boar	black	211.99 ea
MB2277	1967	42-1/2"	Boar	white	211.99 ea
MB2278	1966-67	42-1/2"	Levant	black	211.99 ea
MB2279	1966-67	42-1/2"	Levant	white	211.99 ea
MB2280	1968-69	37-1/2"	Boar	pearl white	242.99 ea
MB2281	1969	37-1/2"	Boar	tan	281.99 ea
MB2282	1968-70	37-1/2"	Boar	black	211.99 ea
MB2283	1968-70	37-1/2"	Boar	antique green	242.99 ea
MB2284	1970	37-1/2"	Boar	white	211.99 ea
E-Body Barracuda						
ME1577	1970	31-3/4"	Boar	antique green	narrow seam.....	242.99 ea
ME1578	1970-74	31-3/4"	Boar	black	narrow seam.....	211.99 ea
ME1579	1970-74	31-3/4"	Boar	white	narrow seam.....	211.99 ea
ME1580	1970-74	31-3/4"	Boar	green	narrow seam.....	281.99 ea
E-Body Challenger						
ME1577	1970	31-3/4"	Boar	antique green	narrow seam.....	242.99 ea
ME1578	1973-74	31-3/4"	Boar	black	narrow seam.....	211.99 ea
ME1579	1973-74	31-3/4"	Boar	white	narrow seam.....	211.99 ea
ME1580	1973-74	31-3/4"	Boar	green	narrow seam.....	281.99 ea
ME1581	1970-72	49"	Boar	black	wide seam.....	265.99 ea
ME1582	1970-72	49"	Boar	white	wide seam.....	265.99 ea



BODY COMPONENTS

Convertible Tops

OEM Quality Tops for Your Convertible!

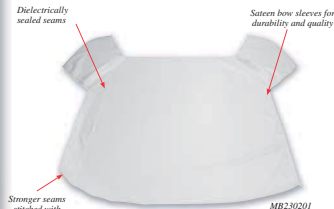

- Includes a Full 36-Month Warranty!
- Correct Pinpoint Material for Early Models and Crush Material for Late Models.



1962-71 Convertible Tops

Each convertible top is manufactured to original specifications with the correct grain material for the specified vehicle. Early models feature the pinpoint material and late models feature the crush material as original. Every top includes installation instructions along with warranty details. These tops are available in two exterior color options, white (01) and black (02). Both colors feature black as the interior color. Please add numerical color code to the part number when ordering. These convertible tops are guaranteed against peeling, leaking, separating or shrinking for three full years from date of purchase. Detailed instructions are included with each convertible top, though we recommend professional installation due to variations in the convertible top frame assembly. The frame sometimes may need to be adjusted for the top to fit properly. Made in USA.

Note: Convertible tops do not include the rear window; sold separately.

A-Body

MA1549	1967-69	pinpoint	Barracuda	199.99	ea
MA1550	1963-64	pinpoint	Dart GT	199.99	ea
MA1551	1965-66	pinpoint	Dart GT	199.99	ea
MA1552	1967-69	pinpoint	Dart	199.99	ea
MA1553	1963-64	pinpoint	Valiant	199.99	ea
MA1554	1965-66	pinpoint	Valiant	199.99	ea

B-Body

MB2303	1962	pinpoint	Fury/Sport Fury	209.99	ea
MB2304	1963	pinpoint	Polara/Fury/Sport Fury	209.99	ea
MB2300	1964-65	pinpoint	all models	199.99	ea
MB2301	1966	pinpoint	all models	199.99	ea
MB2302	1967-70	crush	all models	199.99	ea

E-Body

ME1599	1970-71	crush	all models	199.99	ea
--------	---------	-------	------------	--------	----



100	206	302	406	314	510	610
black	taupe	blue	lt burg	met blue	crimson red	met fawn
1964-71	1963	1963	1963	1964-66	1964-66	1964-66

1963-71 Convertible Well Liners

Manufactured in original style material and colors, these convertible well liners install between the rear seats and the trunk where convertible top folds down. Made in USA.

Note: Please add 3-digit color code when ordering. *Available only in black.

MA4732	1963	Dart/Dart GT	199.99	ea
MA4733	1964-66	Dart/Dart GT	199.99	ea
MA2144*	1967-69	Dart	119.99	ea
MA2145*	1967-69	Barracuda	199.99	ea
MA2146*	1965-66	Valiant	199.99	ea
ME1574*	1970-71	E-Body	119.99	ea

New!



1962-71 Convertible Rear Glass or Plastic Window

Reproduction rear window with surrounding material for convertible models. The material for the rear windows is available in two exterior color options, white and black. Both colors feature black as the interior color. Made in USA.

Note: Please add 2-digit color code when ordering.

1962-71 Plastic Window

Available in the correct pinpoint material for 1962-66 models and crush material for 1967-71 models.

A-Body

MA1557	1967-69	Barracuda	89.99	ea
MA1558	1963-64	Dart GT	89.99	ea
MA1559	1965-66	Dart GT	89.99	ea
MA1560	1967-69	Dart	89.99	ea
MA1561	1963-64	Valiant	89.99	ea
MA1562	1965-66	Valiant	89.99	ea

B-Body

MB2309	1962	Fury/Sport Fury	89.99	ea
MB2310	1963	Fury/Sport Fury	89.99	ea
MB2310	1963	Polara	89.99	ea
MB2306	1964	Polara	89.99	ea
MB2306	1964-65	Coronet 440	89.99	ea
MB2311	1964-65	Plymouth B-Body	89.99	ea
MB2307	1966	Coronet	89.99	ea
MB2307	1966	Plymouth B-Body	89.99	ea
MB2308	1967-70	Coronet	89.99	ea
MB2308	1967-70	Plymouth B-Body	89.99	ea

E-Body

ME1628	1970-71	all models	89.99	ea
--------	---------	------------	-------	----

1967-71 Glass Window

Available in the correct crush material.

Note: Shipped oversize.

MA1555	1967-69	crush	Barracuda	191.99	ea
MA2454	1967-69	pinpoint	Barracuda	191.99	ea
MA1556	1967-69	crush	Dart	191.99	ea

B-Body

MB2305	1967-70	crush	Coronet	191.99	ea
MB2305	1967-70	crush	Plymouth B-Body	191.99	ea

E-Body

ME1627	1970-71	crush	all	191.99	ea
--------	---------	-------	-----	--------	----

Convertible Top Boots



Replacement top boots for the most discerning project. These top boots are what you want to order to achieve the highest quality original look. Each boot attaches like original and is manufactured using factory style material. Available in an assortment of colors to match the interior styling material. 1963-65 boots use Bison grain, 1966-68 use Cologne grain, 1969-71 use Coachman grain (except 1969 Dart GT models, which use Dakota grain). Made in USA.

Important: Top boot storage bag must be purchased separately.
Note: *Uses non-original center seam. **No further discounts apply.

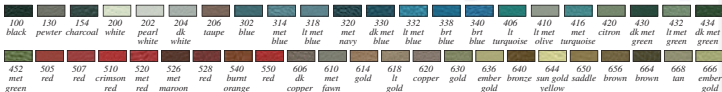

A-Body

1963-69 Dart/Dart GT	taupc	282.99 ea
MA3461205	blue	282.99 ea
MA3461302	blue	282.99 ea
MA3461406	lt turquoise	282.99 ea
MA3461510	crimson red.	282.99 ea
MA3462100	black	282.99 ea
MA3462202	pearl white	282.99 ea
MA3462310	met blue	282.99 ea
MA3462318	lt met blue	282.99 ea
MA3462410*	lt met olive	521.99 ea
MA3462505	crimson red.	282.99 ea
MA3462510	crimson red.	282.99 ea
MA3462520	met red	282.99 ea
MA3462610	met blue	282.99 ea
MA3462614	gold	282.99 ea
MA3464100	black	296.99 ea
MA3464202	pearl white	296.99 ea
MA3464320	met blue	296.99 ea
MA3464332	dk met blue	296.99 ea
MA3464400	met red	296.99 ea
MA3464520	met red	296.99 ea
MA3464620	crimson red.	296.99 ea
MA3466100	black	296.99 ea
MA3466202	pearl white	296.99 ea
MA3466332	met blue	296.99 ea
MA3466432	lt met green	296.99 ea
MA3466507	crimson red.	296.99 ea
MA3466630	met red	296.99 ea

1965-66 Valiant/Valiant Signet

MA3463100	1965-66	black	282.99 ea
MA3463114	1965	met blue	282.99 ea
MA3463318	1966	lt met blue	282.99 ea
MA3463505	1966	red	282.99 ea
MA3463550	1965	red	282.99 ea
MA3463614	1965-66	gold	282.99 ea

1967-69 Barracuda

MA3465100	1967-68	black	296.99 ea
MA3465202	1968	pearl white	296.99 ea
MA3465320	1967-68	met navy	296.99 ea
MA3465332	1968	lt dk met	296.99 ea
MA3465430	1967-68	dk met green	296.99 ea
MA3465520	1967-68	met red	296.99 ea
MA3465526	1968	met maroon	296.99 ea
MA3465618*	1967-68	lt gold	536.99 ea
MA3465620	1967	copper	296.99 ea
MA3465636	1967-68	ember gold	296.99 ea
MA3467100	1969	black	296.99 ea
MA3467130	1969	pewter	296.99 ea
MA3467200	1969	white	296.99 ea
MA3467338	1969	bright blue	296.99 ea
MA3467434	1969	dk met green	296.99 ea
MA3467528	1969	red	296.99 ea
MA3467644	1969	sun gold yellow	296.99 ea
MA3467650	1969	saddle	296.99 ea

B-Body

1963-64 Polara/Polara 500

MB2661100	1963	black	315.99 ea
MB2661204	1963	dk white	315.99 ea
MB2661302	1963	blue	315.99 ea

B-Body Cont'd

MB2661406	1963	lt turquoise	315.99 ea
MB2661500	1963	crimson red	315.99 ea
MB2663100	1964	black	315.99 ea
MB2663318	1964	lt met blue	315.99 ea
MB2663410*	1964	lt met olive	559.99 ea
MB2663416	1964	met turquoise	315.99 ea
MB2663510	1964	crimson red	282.99 ea
MB2663610	1964	dk copper	315.99 ea
MB2663610	1964	met fawn	315.99 ea

1963-64 Fury/Sport Fury

MB2662100	1963	black	315.99 ea
MB2662302	1963	blue	315.99 ea
MB2662510	1963	crimson red	315.99 ea
MB2663100	1964	black	315.99 ea
MB2663318	1964	lt met blue	315.99 ea
MB2663410*	1964	lt met olive	559.99 ea
MB2663416	1964	met turquoise	315.99 ea
MB2663510	1964	crimson red	315.99 ea
MB2663610	1964	dk copper	315.99 ea
MB2663610	1964	met fawn	315.99 ea

1965 Belvedere II/Satellite

MB2664100	1965	black	315.99 ea
MB2664202	1965	pearl white	315.99 ea
MB2664314	1965	met turquoise	315.99 ea
MB2664416	1965	met turquoise	315.99 ea
MB2664510	1965	crimson red	315.99 ea
MB2664520	1965	met red	315.99 ea
MB2664610	1965	met fawn	315.99 ea
MB2664614	1965	gold	315.99 ea

1966-67 Belvedere II/Satellite/GTX

MB2665100	1966-67	black	287.99 ea
MB2665202	1966-67	pearl white	287.99 ea
MB2665318	1966-67	lt met blue	287.99 ea
MB2665320	1966-67	met navy	287.99 ea
MB2665420	1966-67	citron	287.99 ea
MB2665520	1966-67	met red	287.99 ea
MB2665614	1966	gold	287.99 ea
MB2665620	1967	copper	287.99 ea
MB2665630	1967	gold	287.99 ea

1968-70 Roadrunner/Satellite/GTX

MB2666100	1968	black	382.99 ea
MB2666202	1968	pearl white	382.99 ea
MB2666332	1968	lt met blue	382.99 ea
MB2666430	1968	dk met green	382.99 ea
MB2666432	1968	lt met green	382.99 ea
MB2666526	1968	met maroon	382.99 ea
MB2667100	1969-70	black	382.99 ea
MB2667130	1969-70	pewter	382.99 ea
MB2667154	1969-70	charcoal	382.99 ea
MB2667200	1969-70	white	382.99 ea
MB2667330	1969-70	dk met blue	382.99 ea
MB2667338	1969-70	bright blue	382.99 ea
MB2667434	1969-70	dk met green	382.99 ea
MB2667528	1969-70	red	382.99 ea
MB2667540	1970	burnt orange	382.99 ea
MB2667640	1969	bronze	382.99 ea
MB2667650	1969	saddle	382.99 ea
MB2667656	1970	brown	382.99 ea

1965-70 Coronet/Coronet 500

MB2664100	1964-65	black	315.99 ea
-----------	---------	-------	-----------

B-Body Cont'd

MB2664202	1964-65	pearl white	315.99 ea
MB2664314	1964-65	met blue	315.99 ea
MB2664416	1964-65	met turquoise	315.99 ea
MB2664510	1964-65	crimson red	315.99 ea
MB2664520	1965	met red	315.99 ea
MB2664610	1964-65	met fawn	315.99 ea
MB2664614	1965	gold	315.99 ea
MB2665100	1966-67	black	287.99 ea
MB2665202	1966-67	pearl white	287.99 ea
MB2665318	1966-67	lt met blue	287.99 ea
MB2665320	1966-67	met navy	287.99 ea
MB2665420	1966-67	citron	287.99 ea
MB2665520	1966-67	met red	287.99 ea
MB2665614	1966	gold	287.99 ea
MB2665620	1967	copper	287.99 ea
MB2665630	1967	gold	287.99 ea
MB2665610	1968	black	382.99 ea
MB2666202	1968	pearl white	382.99 ea
MB2666332	1968	lt met blue	382.99 ea
MB2666430	1968	dk met green	382.99 ea
MB2666432	1968	lt met green	382.99 ea
MB2666526	1968	met maroon	382.99 ea
MB2667100	1969-70	black	382.99 ea
MB2667130	1969-70	pewter	382.99 ea
MB2667154	1969-70	charcoal	382.99 ea
MB2667200	1969-70	white	382.99 ea
MB2667330	1969-70	dk met blue	382.99 ea
MB2667338	1969-70	bright blue	382.99 ea
MB2667434	1969-70	dk met green	382.99 ea
MB2667528	1969	red	382.99 ea
MB2667540	1970	burnt orange	382.99 ea
MB2667640	1969	bronze	382.99 ea
MB2667650	1969	saddle	382.99 ea
MB2667656	1970	brown	382.99 ea

E-Body

1970-71 Barracuda

ME1760100	1970-71	black	311.99 ea
ME1760154	1970	charcoal	311.99 ea
ME1760200	1970-71	white	311.99 ea
ME1760338	1970	bright blue	311.99 ea
ME1760430	1971	bright blue	311.99 ea
ME1760434	1970	dk met green	311.99 ea
ME1760452	1971	met green	311.99 ea
ME1760540	1970-71	burnt orange	311.99 ea
ME1760550	1970	red	311.99 ea
ME1760656	1971	brown	311.99 ea
ME1760664	1971	brown	311.99 ea
ME1760668	1971	tan	311.99 ea

1970-71 Challenger

ME1761100	1970-71	black	311.99 ea
ME1761200	1970-71	white	311.99 ea
ME1761338	1970	bright blue	311.99 ea
ME1761430	1971	bright blue	311.99 ea
ME1761434	1970-71	dk met green	311.99 ea
ME1761540	1970	burnt orange	311.99 ea
ME1761550	1970	red	311.99 ea
ME1761656	1971	brown	311.99 ea
ME1761664	1971	brown	311.99 ea
ME1761666	1970-71	ember gold	311.99 ea

Convertible Top Parts



1960-71 Convertible Top Pads

When replacing your convertible top, the worn out top pads should also be replaced. Each pad offers an original appearance. Used as reinforcement between top frame and convertible top on the inside of the vehicle. Each measures 65" and is black in color.

K54000 1960-71 34.99 pr



1963-71 Convertible Anti Rattle Clip

Is your convertible top moving, shaking and rattling so much it's driving you crazy? Replace your anti rattle clips to secure your top and reclaim your sanity. MN1862 1963-70 A, B-Body 12.99 pr
ME836038 1971 E-Body 34.99 pr



1966-71 Convertible Top Latches

Convertible top latches for various 1967-69 A-Body, 1966-70 B-Body and 1970-71 E-Body models. Features correct finish and will fit like original for all convertible top models of the year and body type specified.

MD2126 1967-69 A-Body 99.99 pr
MD2126 1966-70 B-Body 99.99 pr
ME1567 1970-71 E-Body 294.99 pr



1968-71 B & E-Body Convertible Boot Clips

Boot clips for all 1968-70 B-Body and 1970-71 E-Body models. These plastic clips are sewn into the convertible top boot for attachment.

MB2285 1968-70 B-Body 4.99 ea
ME1583 1970-71 E-Body 4.99 ea

New!

OE AUTHORIZED



1970-71 E-Body Boot Well Moldings

Replacement boot well moldings for 1970-71 E-Body convertible models. This three piece molding set features the correct stainless finish with factory contours and can be mounted using original or reproduction mounting hardware. Mounting clips included with molding sets, and also available separately.

Molding Sets
ME175928 1970-71 Barracuda 289.99 set

ME12227 1970-71 Challenger 289.99 set

Mounting Hardware
ME12228 1970-71 hardware 69.99 set

New!



OE

1960-76 Convertible Top Binding End Clip

Reproduction of the top rear binding end clip for 1960-76 convertible models. These stainless steel covers finishes both ends of the rear window outer top bow binding trim strip.

7614749 1960-76 2 required 3.79 ea



Top Boot Storage Bag

Keep your top boot clean and safe by storing it in this special top boot storage bag. The dimensions allow the boot plenty of space so that it doesn't get wrinkled when not in use. Manufactured using heavy weight vinyl and features a snap down lock for added protection.

K51020 34.99 ea



1970-71 E-Body Wind Deflectors

Wind deflectors for 1970-71 Barracuda and Challenger models. Replace your damaged or missing originals with this set that feature the original part number on the inner side of the panel.

ME1570 1970-71 184.99 pr



1970-71 E-Body Convertible Boot Retainer

Boot retainer for 1970-71 Barracuda and Challenger models. This replacement screws to the back side of the rear seat back.

ME1568 1970-71 204.99 ea

New!



1963-67 A/B-Body Convertible Transition Moldings

Reproduction convertible transition moldings for 1963-69 A and 1966-67 B-Body models. These transition moldings mount on the quarter panels of convertible cars, either by the quarter window (front) or near the trunk (rear). Manufactured in a two-part alloy that won't pit like the original post metal pieces.

A-Body			
MP41224	1963-64	Valiant	LH - front 69.99 ea
MP41225	1963-64	Valiant	RH - front 69.99 ea
MP41226	1963-64	Dart	LH - front 79.99 ea
MP41227	1963-64	Dart	RH - front 79.99 ea
MP41228	1965	Dart GT	LH - front 79.99 ea
MP41229	1965	Dart GT	RH - front 79.99 ea
MP41230	1965	Valiant	LH - front 69.99 ea
MP41231	1965	Valiant	RH - front 69.99 ea
MP41232	1966	Dart 270	LH - front 69.99 ea
MP41233	1966	Dart 270	RH - front 69.99 ea
MP41234	1967-69	Dart	front - w/top edge molding 159.99 pr
B-Body			
MP41235	1966-67	B-Body	LH - front 79.99 ea
MP41236	1966-67	B-Body	RH - front 79.99 ea
MP41237	1966-67	B-Body	LH - rear 104.99 ea
MP41238	1966-67	B-Body	RH - rear 104.99 ea



1964 Polara Convertible Belt Moldings

Quarter panel belt moldings for 1964 convertible Polara models. These chrome moldings install onto the top of the quarter panel and act as a mounting point for the convertible top.

MB2256 1964 474.99 pr



1968-70 B-Body Convertible Belt Moldings

Belt moldings for 1968-70 Dodge and Plymouth B-Bodies. Feature correct chrome plating and contours like original. These moldings mount to the top of the quarter panel behind the front door. Sold as a four piece set.

MB2257 1968-70 Dodge 314.99 set

MB2258 1968-70 Plymouth 314.99 set



1970-71 E-Body Convertible Belt Moldings

Convertible belt moldings for 1970-71 Barracuda and Challenger models. Features correct chrome plating and original part number stamp. These moldings mount to the top of the quarter panel behind the front door.

ME1571 1970-71 Barracuda 264.99 pr

ME1572 1971 Barracuda 264.99 pr

ME1573 1970-71 Challenger 94.99 pr

Convertible Parts/Body Plugs



A-Body 1970-71 E-Body Convertible Top Switch

Convertible toggle switch for 1970-71 Barracuda and Challenger models. Features the correct black plastic knob. This switch mounts on the dash below the windshield washer switch.

ME1569 1970-71 204.99 ea



MD2198

1962-71 Convertible Top Actuator Cylinders

After years of use, the factory top actuator cylinders will wear out and leak. Manufactured from aluminum, the appearance is slightly different from the original but will fit and function correctly. Two cylinders are required per vehicle.

A-Body MA2226 1963-66 139.99 ea

MD2198 1967-69 139.99 ea

B-Body MB2298 1962-63 139.99 ea

MB2299 1964-65 139.99 ea

MD2198 1966-70 139.99 ea

E-Body ME1593 1970-71 139.99 ea



MD2129

1961-71 Convertible Motor/Pump Assembly

OE-style replacement motor and pump assembly for 1961-71 convertibles. Features original style and locations for electric and fluid connections. These pump assemblies will fit all models for the years specified.

MD2128 1961-64 219.99 ea

MD2129 1965-71 219.99 ea



Convertible Top Hydraulic Hose Assemblies

Replacement hose assemblies for all convertible models complete with all fittings attached. These assemblies run from the motor/pump to the lift cylinders and back. One set does both cylinders.

Note: This is a replacement set and may slightly differ in length from your originals, but will function correctly.

HK234 99.99 set



1961-71 Convertible Top Motor Grommet Kit

Grommets on the power top motor can become worn or weathered over time and need to be replaced to reduce noise and vibration during top operation. Check your grommets for wear and replace them if necessary. Kit includes 4 rubber grommets.

MD2127 1961-71 5.99 kit



MN1798

1963-74 Standard Body Plug Set

When doing a full restoration, it's a good idea to replace all of the body plugs under the vehicle too. These plugs are used to seal off bolts under your vehicle and prevent dirt from entering. Each set contains the correct size and style plugs in plastic and rubber for the floor pans, trunk floor and trunk floor extensions.

A-Body MN1799 1963-66 all 49.99 set

MN1800 1967-69 all 49.99 set

MN1801 1970-74 all 49.99 set

B-Body MN1806 1964-65 Belvedere, Satellite 49.99 set

MN1816 1966-67 all 49.99 set

MN1802 1968 all 59.99 set

MN1803 1969 all 59.99 set

MN1804 1970 all 59.99 set

MN1805 1971-72 all 59.99 set

E-Body MN1811 1970 Challenger 79.99 set

MN1825 1970 Barracuda 59.99 set

MN1798 1971-74 Barracuda 59.99 set

MN1798 1971-74 Challenger 59.99 set



MN1815

1967-74 Super Body Plug Set

When doing a full restoration it is a very good idea to replace all of the body plugs under your vehicle. These plugs seal off bolts under your vehicle and prevent dirt from entering. These kits are similar to the standard set, but includes much more. Each set includes galvanized steel body plugs (E-Body only), sun visor tips, auto trans firewall plug, 4-speed firewall rod boot, door plug kit, steel/rubber shock plugs (E-Body only), firewall drain door (B & E-Body only), and the miscellaneous plugs included in the standard set.

A-Body MN1808 1967-69 69.99 set

MN1809 1970-74 69.99 set

B-Body MN1810 1966-67 exc Charger 79.99 set

MN1817 1968 79.99 set

MN1818 1969 79.99 set

MN1812 1970 79.99 set

MN1819 1971-72 79.99 set

E-Body MN1813 1970 Barracuda 114.99 set

MN1814 1970 Challenger 109.99 set

MN1815 1971-74 Barracuda 109.99 set

MN1815 1971-74 Challenger 109.99 set



ME539

MD2114

MD2113

1960-76 Body and Trunk Plugs

Body and trunk plugs in various sizes for 1960-76 Mopar models. Seal your replacement or original floor pans from road debris and water. Manufactured of rubber for original appearance, fit and function.

1960-76 Body and Trunk Plugs

Rubber body and trunk plugs for most body styles of 1960 and up Dodge and Plymouth models where a 1-1/8" or 1-7/8" hole plug is necessary.

MD2113 1960-76 1-1/8" 2.99 ea

MD2114 1960-76 1-7/8" 2.99 ea

1970-74 B & E-Body Trunk Plug

Rubber trunk plug for 1970-74 B-Body and E-Body models. This floor plug is 2-1/8" OD and fits a 1-3/4" hole.

MD2115 1970-74 1-3/4" 2.99 ea

1970-74 E-Body Trunk Plugs

Trunk plug and special socket plug for 1970-74 Barracuda and Challenger models. This rubber floor plug fits a hole from 1-13/16" to 1-7/8".

ME539 1970-74 1-13/16"-1-7/8" 4.99 ea



1970 E-Body Rear Upper Shock Plug

Replacement shock plug for all 1970 E-Body models. This piece installs on the trunk floor and covers the rear shock access hole. Two required per vehicle.

ME5048 1970 14.99 ea

New!



T243



T245

Stainless Steel Magnetic Parts Trays

Put an end to lost parts with these magnetic trays! Powerful rubber-coated magnets keep your parts where they belong and prevent the tray from sliding on metal surfaces. Manufactured from durable stainless steel with a partial lid to keep parts in their place.

T243 circular single magnet dish 9.99 ea

T245 rectangular double magnet tray 17.99 ea

Floor Panel Repair



MM1384



MM1387A

1962-74 A, B & E-Body Floor Pans

Don't mess around with patching your floor one section at a time. If the floor pan in your A, B or E-Body is rusted in multiple places, simply replace the whole pan at one time. Our quality, one-piece floor pans offer less hassle for installation and no patched seams for a cleaner restoration, greater strength and durability than a patchwork of sheet metal pieces possibly can. Plus, save hours of costly body shop labor when welding in one panel instead of many. Available in your choice of Restorer's Choice pans, manufactured in OE-gauge steel featuring all original contours and details or our standard replacement for the car builder on a budget. For years, restorers have only had partial floor pans to use on rusted areas, but no longer! Comes finished in semi-flat black EDP coating to prevent rust.

Note: Shipped truck freight.

Restorer's Choice Floor Pans

A-Body			
MM1384	1967-69	Barracuda.....	409.99 ea
MM1383	1967-74	Dart	409.99 ea
MM1384	1970-74	Dart Sport, Demon, Duster.....	409.99 ea
B-Body			
MM1385	1962-65	all models.....	599.99 ea
MM1386B	1966-70	all models.....	479.99 ea
MM1388B	1971-72	all models.....	479.99 ea
MM1387B	1970	all models without rear seat pan.....	479.99 ea
MM1389	1970	Challenger w/rear seat pan, w/o braces.....	349.99 ea
MM1390	1970	Challenger w/rear seat pan & braces.....	779.99 ea
MM1388B	1971-74	all models without rear seat pan.....	479.99 ea

Standard Replacement Floor Pans

B-Body			
MM1386A	1966-70	all models.....	379.99 ea
MM1388A	1971-72	all models.....	379.99 ea
E-Body			
MM1387A	1970	all models without rear seat pan.....	334.99 ea

New!



MA688008



MM1619

1966-76 Floor Wiring Covers

Replacement floor wiring covers for various 1966-76 models. These covers run next to the rocker panel and originals often break during removal due to rust damage.

A-Body			
MA688008	1967-69	Barracuda.....	104.99 set
MA688009	1967-76	Dart	104.99 set
MA688008	1970-76	Duster.....	104.99 set
MA688008	1971-72	Demon	104.99 set
MA688008	1973-76	Dart Sport	104.99 set
B-Body			
MM1619	1966-70	B-Body.....	94.99 set
MM1620	1970-74	Barracuda.....	94.99 set
MM1621	1970-74	Challenger.....	94.99 set

New!



MM1562B



MM1563B



1966-74 Floor Support Braces

Reproduction floor support braces for various 1966-74 Mopar Band E-Body models. These braces are welded to the front and rear of the front floor pan to provide additional support. Manufactured in OE-gauge steel featuring all original contours and details and officially licensed as a Mopar Authentic Restoration Product. Comes finished in semi-flat black EDP coating to prevent rust.

Restorer's Choice

MM1562B	1966-70	B-Body.....	111.99 set
MM1563B	1970-74	E-Body.....	111.99 set

Standard Replacement

MM8299	1966-70	B-Body - front - LH or RH.....	34.99 ea
MM8298	1966-70	B-Body - rear - LH or RH.....	34.99 ea

Floor Panel Repair



MM1530



MM1531



MM1534



MM1535

1966-76 Floor Pan Halves



Get the floor pan of your 1966-74 A, B or E-Body back into shape. Each reproduction floor pan half features correct contours and comes EDP coated for rust prevention.
Note: Shipped double oversize.

A-Body	
MM1528	1967-69 LH, Barracuda 169.99 ea
MM1529	1967-69 RH, Barracuda 169.99 ea
MM1526	1967-76 LH, Dart 139.99 ea
MM1527	1967-76 RH, Dart 139.99 ea
MM1528	1970-74 LH, Dart Sport, Demon, Duster 169.99 ea
MM1529	1970-74 RH, Dart Sport, Demon, Duster 169.99 ea
B-Body	
MM1530	1966-70 LH, all 179.99 ea
MM1531	1966-70 RH, all 179.99 ea
E-Body	
MM1532	1970 LH, with flange 179.99 ea
MM1533	1970 RH, with flange 179.99 ea
MM1534	1971-74 LH 179.99 ea
MM1535	1971-74 RH 179.99 ea



MMR836020



MMR836021



MMR836024



MMR836025



1960-76 Rust Repair Front Floor Board Panels

Replacement front floor board manufactured from 18 gauge steel to be used as a rust repair panel for various 1960-76 models. This panel features original style shape, but is not designed to be an exact reproduction. Made in USA.

*Important: Drain hole must be cut out of original drain plug is to be used.
Note: Shipped oversize.*

A-Body		MS1
MMR836018	1961-62 LH Lancer	64.99 ea
MMR836019	1961-62 RH Lancer	64.99 ea
MMR836020	1967-69 LH Barracuda	64.99 ea
MMR836021	1967-69 RH Barracuda	64.99 ea
MMR836018	1960-65 LH Dart	64.99 ea
MMR836019	1960-65 RH Dart	64.99 ea
MMR836020	1967-76 LH Dart	64.99 ea
MMR836021	1967-76 RH Dart	64.99 ea
MMR836020	1969-76 LH Dart Swinger	64.99 ea
MMR836021	1969-76 RH Dart Swinger	64.99 ea
MMR836020	1971-72 LH Demon	64.99 ea
MMR836021	1971-72 RH Demon	64.99 ea
MMR836020	1970-76 LH Duster	64.99 ea
MMR836021	1970-76 RH Duster	64.99 ea
MMR836020	1971-76 LH Scamp	64.99 ea
MMR836021	1971-76 RH Scamp	64.99 ea
MMR836018	1960-65 LH Valiant	64.99 ea
MMR836019	1960-65 RH Valiant	64.99 ea
MMR836020	1967-76 LH Valiant	64.99 ea
MMR836021	1967-76 RH Valiant	64.99 ea
B-Body		
MMR836022	1962-64 LH Polara	64.99 ea
MMR836023	1962-64 RH Polara	64.99 ea
MMR836022	1965 LH Coronet	64.99 ea
MMR836023	1965 RH Coronet	64.99 ea
MMR836024	1966-67 LH Coronet	64.99 ea
MMR836025	1966-67 RH Coronet	64.99 ea
MMR836024	1968-70 LH Super Bee	64.99 ea
MMR836025	1968-70 RH Super Bee	64.99 ea
MMR836024	1966-70 LH Charger	64.99 ea
MMR836025	1966-70 RH Charger	64.99 ea
MMR836026	1971-74 LH Charger	64.99 ea
MMR836027	1971-74 RH Charger	64.99 ea
MMR836022	1962-65 LH Belvedere	64.99 ea
MMR836023	1962-65 RH Belvedere	64.99 ea
MMR836024	1966-70 LH Belvedere	64.99 ea
MMR836025	1966-70 RH Belvedere	64.99 ea
MMR836024	1968-70 LH Satellite/Road Runner/GTX	64.99 ea
MMR836025	1968-70 RH Satellite/Road Runner/GTX	64.99 ea
MMR836026	1971-74 LH Satellite/Road Runner	64.99 ea
MMR836027	1971-74 RH Satellite/Road Runner	64.99 ea
E-Body		
MMR836026	1970-74 LH Barracuda/Challenger	64.99 ea
MMR836027	1970-74 RH Barracuda/Challenger	64.99 ea

Floor Panel Repair



1964-65 B-Body Shift Tunnel 4-Speed Conversion Panel

Replace the tunnel portion of the shifter area without replacing the entire floor pan! These quality stamped panels may be used to repair a hack job on a floor shifter installation or to convert automatic transmission cars to 4-speed.

MM8262	1964-65	Belvedere	179.99 ea
MM8262	1965	Coronet	179.99 ea



MM1229



MM1230

1967-74 Shift Tunnel Panels

Now you can replace the tunnel portion of the shifter area without replacing the entire floor pan. We offer quality stamped panels to repair a hack job on a shifter installation. This panel can be used as a four speed replacement panel or as a conversion panel for models with automatic transmission.

MM1227	1967-74	all	144.99 ea
--------	---------	-----	-----------

A-Body			
MM1228	1966-70	all	144.99 ea
MM1229	1971-74	without console	144.99 ea
MM1230	1971-74	with console	144.99 ea

E-Body			
MM1230	1970-74	with console	144.99 ea

New!



MM1123B

MM1123A



1966-76 Torsion Bar Cross Member

Factory-style replacement torsion bar cross member for various 1966-76 models. Available as a Restorer's Choice cross member, manufactured in OE-gauge steel, officially licensed by Mopar, featuring all original contours and details or our more economical standard replacement for the car builder on a budget. This cross member runs under the floor pan from side to side and anchors the rear of the front torsion bars. Each cross member comes finished in black EDP coating to prevent rust.

Note: Shipped double oversize.

Restorer's Choice

MA688017B	1967-76	A-Body	349.99 ea
MM1122B	1966-70	B-Body	389.99 ea
MM1123B	1970	E-Body	389.99 ea

Standard Replacement

MM1122A	1966-70	B-Body	304.99 ea
MM1123A	1970	E-Body	309.99 ea



MM8148

1960-76 Torsion Mount Frame Repair Cap

Torsion bar cross members often trap mud and dirt inside and it weakens them, causing them to rust out from the inside out, meaning the torsion bar no longer supports the chassis and the suspension is severely compromised. This frame repair cap will remedy this problem.

A-Body

MM8148	1960-76	LH	149.99 ea
MM8149	1960-76	RH	149.99 ea
MM8150	1960-76	LH & RH	309.99 pr

B-Body

MM8000	1966-70	LH	149.99 ea
MM8001	1966-70	RH	149.99 ea
MM8002	1966-70	LH & RH	242.99 pr
MM8003	1971-72	LH	134.99 ea
MM8004	1971-72	RH	139.99 ea
MM8005	1971-72	LH & RH	233.99 pr
MM8006	1962-65	LH	169.99 ea
MM8007	1962-65	RH	169.99 ea
MM8008	1962-65	LH & RH	233.99 pr

E-Body

MM8118	1970-74	LH	159.99 ea
MM8119	1970-74	RH	159.99 ea
MM8120	1970-74	LH & RH	299.99 pr



MM836032



MM836033

1963-76 Rear Floor Board Repair Panels

These rear floor board repair panels are manufactured from 18 gauge steel and feature correct contours to match the rear passenger foot area behind the front seat.

Important: Drain plug hole is stamped, but not pre-cut.

Note: Shipped oversize.

A-Body

MM836030	1967-69	LH	Barracuda	69.99 ea
MM836031	1967-69	RH	Barracuda	69.99 ea
MM836030	1967-76	LH	Dart	69.99 ea
MM836031	1967-76	RH	Dart	69.99 ea
MM836030	1969-76	LH	Dart Swinger	69.99 ea
MM836031	1969-76	RH	Dart Swinger	69.99 ea
MM836030	1970-71	LH	Demon	69.99 ea
MM836031	1970-71	RH	Demon	69.99 ea
MM836030	1970-76	LH	Duster	69.99 ea
MM836031	1970-76	RH	Duster	69.99 ea
MM836030	1971-76	LH	Scamp	69.99 ea
MM836031	1971-76	RH	Scamp	69.99 ea
MM836030	1967-76	LH	Valiant	69.99 ea
MM836031	1967-76	RH	Valiant	69.99 ea

B-Body

MM836032	1966-70	LH	Charger	69.99 ea
MM836033	1966-70	RH	Charger	69.99 ea
MM836034	1971-74	LH	Charger	69.99 ea
MM836035	1971-74	RH	Charger	69.99 ea
MM836036	1963-65	LH	Coronet	69.99 ea
MM836037	1964-65	RH	Coronet	69.99 ea
MM836032	1966-67	LH	Coronet	69.99 ea
MM836033	1966-67	RH	Coronet	69.99 ea
MM836032	1968-70	LH	Super Bee	69.99 ea
MM836033	1968-70	RH	Super Bee	69.99 ea
MM836036	1964-65	LH	Belvedere	69.99 ea
MM836037	1964-65	RH	Belvedere	69.99 ea
MM836032	1966-70	LH	Belvedere	69.99 ea
MM836033	1966-70	RH	Belvedere	69.99 ea
MM836036	1963-64	LH	Fury	69.99 ea
MM836037	1963-64	RH	Fury	69.99 ea
MM836032	1968-70	LH	GT/Satellite/Road Runner	69.99 ea
MM836033	1968-70	RH	GT/Satellite/Road Runner	69.99 ea
MM836034	1971-74	LH	Satellite/Road Runner	69.99 ea
MM836035	1971-74	RH	Satellite/Road Runner	69.99 ea

Floor Panel Repair



MM1536



MM1537



MM1538



MM1540B



MM1541A



MM1544B



MM1549A



MM1549B



1962-74 Rear Floor Pan Repair Panel

Replacement rear floor pan sections for various 1962-74 A, B and E-Body models. This is a great solution if only the rear floor pan/footwell area is rusted or damaged. Features correct contours and comes EDP coated for rust prevention.

Note: Shipped oversize.



Restorers Choice

A-Body					
MM1536	1967-74	LH	Dart	58.99 ea
MM1537	1967-74	RH	Dart	58.99 ea

B-Body					
MM1538	1962-64	LH	all	179.99 ea
MM1539	1962-64	RH	all	179.99 ea
MM1538	1965	LH	all	179.99 ea
MM1539	1965	RH	all	179.99 ea
MM1540B	1966-70	LH	all	119.99 ea
MM1541B	1966-70	RH	all	119.99 ea
MM1542	1971	LH	all	119.99 ea
MM1543	1971	RH	all	119.99 ea

E-Body					
MM1544B	1970	LH	Barracuda	119.99 ea
MM1545B	1970	RH	Barracuda	119.99 ea
MM1546	1971-74	LH	Barracuda	119.99 ea
MM1547	1971-74	RH	Barracuda	119.99 ea
MM1548B	1970	LH	Challenger	119.99 ea
MM1549B	1970	RH	Challenger	119.99 ea
MM1550	1971-74	LH	Challenger	119.99 ea
MM1551	1971-74	RH	Challenger	119.99 ea

Standard Replacement

B-Body					
MM1540A	1966-70	LH	all	94.99 ea
MM1541A	1966-70	RH	all	94.99 ea

E-Body					
MM1544A	1970	LH	Barracuda	94.99 ea
MM1545A	1970	RH	Barracuda	94.99 ea
MM1548A	1970-74	LH	Challenger	94.99 ea
MM1549A	1970-74	RH	Challenger	94.99 ea



MM8137



1966-74 Seat Mounts

If your floor pans are rusted out, check the seat mounts along the inner rocker which are also prone to corrosion. If necessary, install these direct replacement seat mounts, made from 13 gauge steel. Sets include four mounts. Made in the USA.
 MM8040 1966-70 B-Body..... 129.99 set
 MM8137 1970-74 E-Body..... 129.99 set



MM1382B



MM1381A



1966-74 B-Body & E-Body Rear Seat Floor Pans

Factory-style replacement rear under-seat floor pan for various 1966-70 B-Body and 1970-74 E-Body models. Features correct contours, pre-installed drain plugs and brackets for pinion snubbers, exhaust, seat belts and the emergency brake cable already welded in place. Your choice of our Restorer's Choice panel, officially licensed by Mopar, manufactured in OE-gauge steel featuring all original contours and details or our standard replacement for the car builder on a budget. Comes finished in black EDP coating to prevent rust.
 Note: Shipped truck freight.

Restorers Choice

MM1381B	1966-70	B-Body	369.99 ea
MM1382B	1970-74	E-Body	369.99 ea

Standard Replacement

MM1381A	1966-70	B-Body	259.99 ea
MM1382A	1970-74	E-Body	269.99 ea



MM1375

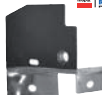

MM1376

1970-71 E-Body Rear Seat Belt Brackets

Replacement rear lower seat belt brackets for 1970-71 E-Body models. These brackets are welded to the front of the inner wheelhouse and act as an anchor point for rear seat belts.

MM1375	1970-71	LH	21.99 ea
MM1376	1970-71	RH	21.99 ea

Trunk Floor Repair



MM1260B



MM1260A



1962-76 Trunk Floor Pans

Factory-style replacement trunk floor for various 1962-76 models. Replacing the entire trunk floor is the best way to totally eliminate rust in the trunk area and ensure the structural integrity of your trunk. Your choice of our Restorer's Choice panel, officially licensed by Mopar, manufactured in OE-gauge steel featuring all original contours and details or our standard replacement for the car builder on a budget. Either choice comes finished in black EDP coating to prevent rust.

Note: Shipped truck freight.

Restorer's Choice

A-Body	Year	Model	Price
MM1071	1967-69	Barracuda	294.99 ea
MM1071	1967-76	Dart	294.99 ea
MM1071	1967-69	Valiant	294.99 ea
MM1071	1970-76	Dart Sport, Demon, Duster	294.99 ea

B-Body	Year	Model	Price
MM1090	1962-65	all models	609.99 ea
MM1769	1966-67	all models	349.99 ea
MM8309	1968	Charger (early 1968 models)	339.99 ea
MM1047B	1968-70	all models (except Charger)	334.99 ea
MM1257B	1968-70	Charger	334.99 ea
MM1025	1971-73	all models	334.99 ea

E-Body	Year	Model	Price
MM1258	1970	Barracuda	334.99 ea
MM1259B	1971-74	Barracuda	334.99 ea
MM1260B	1970	Challenger	334.99 ea
MM1261	1971-74	Challenger	334.99 ea

Standard Replacement

B-Body	Year	Model	Price
MM1047A	1968-70	all models (except Charger)	259.99 ea
MM1257A	1968-70	Charger	259.99 ea

E-Body	Year	Model	Price
MM1259A	1970-74	Barracuda w/o shock access holes	249.99 ea
MM1260A	1970-74	Challenger w/o shock access holes	259.99 ea



MM1266



MM1267

1968-74 B & E-Body Partial Trunk Floors

Partial trunk floors for 1968-74 models. Partial trunk floor panels are a great way to eliminate rust when replacing the entire floor is not necessary. Features correct contours, drain plug holes and comes EDP coated for rust prevention.

Note: Shipped double oversize. *Shipped truck freight.

B-Body	Year	Model	Price
MM1262*	1968-70	LH all models (except Charger)	159.99 ea
MM1263*	1968-70	RH all models (except Charger)	159.99 ea
MM1266*	1968-70	LH Charger	159.99 ea
MM1267*	1968-70	RH Charger	159.99 ea
MM1264*	1971-73	LH all models	159.99 ea
MM1265*	1971-73	RH all models	159.99 ea

E-Body	Year	Model	Price
MM1268	1970	LH Barracuda	159.99 ea
MM1269	1970	RH Barracuda	159.99 ea
MM1270	1971-74	LH Barracuda	159.99 ea
MM1271	1971-74	RH Barracuda	159.99 ea
MM1272	1970	LH Challenger	159.99 ea
MM1273	1970	RH Challenger	159.99 ea
MM1274	1971-74	LH Challenger	159.99 ea
MM1275	1971-74	RH Challenger	159.99 ea

New!



MM1558B



MM1560B



1962-74 B and E-Body Trunk Floor Reinforcements

Trunk floor reinforcements for various 1962-74 B and E-Body models. Your choice of our Restorer's Choice panel, officially licensed by Mopar, manufactured in OE-gauge steel featuring all original contours and details or our standard replacement for the car builder on a budget. Welded under the center trunk pan to add support, these reinforcements feature correct contours and come EDP coated for rust prevention.

Restorer's Choice

B-Body	Year	Model	Price
MM1557	1962-65		99.99 ea
MM1558B	1968-70		114.99 set
MM1559	1971-73		109.99 pr

E-Body	Year	Model	Price
MM1560B	1970-74		109.99 pr

Standard Replacement

B-Body	Year	Model	Price
MM1558A	1968-70		99.99 set

E-Body	Year	Model	Price
MM1560A	1970-74		75.99 pr

88 BODY COMPONENTS

Trunk Floor Repair

New!



MM1420

MM1426



MM1428

MM1434B



MM1438B

MM1440B



1962-76 Trunk Floor Extensions

Factory-style replacement trunk floor extensions for various 1962-76 models. Often rusted out or damaged, these panels comprise the sheet metal area on the sides of the trunk pan where the trunk pan drops off and meets the lower rear quarter panel. Your choice of our Restorer's Choice panel, officially licensed by Mopar, manufactured in OE-gauge steel featuring all original contours and details or our standard replacement for the car builder on a budget. Comes finished in black EDP coating to prevent rust.

Restorer's Choice

A-Body	Year	Side	Model	Price
MAR22056	1967-69	LH	Barracuda	129.99 ea
MA822057	1967-69	RH	Barracuda	129.99 ea
MM1420	1967-69	LH	Dart	94.99 ea
MM1421	1967-69	RH	Dart	94.99 ea
MM1422	1970-74	LH	Dart	94.99 ea
MM1423	1970-74	RH	Dart	94.99 ea
MM1424	1970-76	LH	Dart Sport, Demon, Duster	94.99 ea
MM1425	1970-76	RH	Dart Sport, Demon, Duster	94.99 ea

Dodge B-Body

MM1426	1962-65	LH	all models	109.99 ea
MM1427	1962-65	RH	all models	109.99 ea
MM1428	1968-70	LH	except Charger	118.99 ea
MM1429	1968-70	RH	except Charger	118.99 ea
MM1430	1968-70	LH	Charger	124.99 ea
MM1431	1968-70	RH	Charger	124.99 ea
MM1432	1971-74	LH	Charger	124.99 ea
MM1433	1971-74	RH	Charger	124.99 ea

Plymouth B-Body

MM1426	1962-65	LH	all models	109.99 ea
MM1427	1962-65	RH	all models	109.99 ea
MM1434B	1968-70	LH	all models	119.99 ea
MM1435B	1968-70	RH	all models	119.99 ea
MM1436B	1971-74	LH	all models	124.99 ea
MM1437B	1971-74	RH	all models	124.99 ea

E-Body

MM1438B	1970-74	LH	Barracuda	119.99 ea
MM1439B	1970-74	RH	Barracuda	119.99 ea
MM1440B	1970-74	LH	Challenger	119.99 ea
MM1441B	1970-74	RH	Challenger	119.99 ea

Standard Replacement

Dodge B-Body

MM8200	1966-67	LH	all	99.99 ea
MM8199	1966-67	RH	all	99.99 ea
MM1430A	1968-70	LH	Charger	99.99 ea
MM1431A	1968-70	RH	Charger	99.99 ea

Plymouth B-Body

MM8200	1966-67	LH	all	99.99 ea
MM8199	1966-67	RH	all	99.99 ea
MM1434A	1968-70	LH	all models	99.99 ea
MM1435A	1968-70	RH	all models	99.99 ea
MM1436A	1971-74	LH	all models	99.99 ea
MM1437A	1971-74	RH	all models	99.99 ea

E-Body

MM1438A	1970-74	LH	Barracuda	94.99 ea
MM1439A	1970-74	RH	Barracuda	94.99 ea
MM1440A	1970-74	LH	Challenger	79.99 ea
MM1441A	1970-74	RH	Challenger	79.99 ea

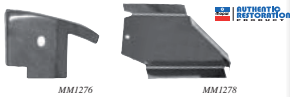

MM1276

MM1278

1970-76 A & B-Body Trunk Extension End Cap

Trunk floor extension end cap for 1970-76 A and B-Body models. This end cap is welded to the rear side of the trunk floor extension.

A-Body

MM1276	1970-76	LH	Dart Sport, Demon, Duster	34.99 ea
MM1277	1970-76	RH	Dart Sport, Demon, Duster	34.99 ea

B-Body

MM1278	1971-74	LH	all	19.99 ea
MM1279	1971-74	RH	all	19.99 ea



1962-65 B-Body Center Trunk Floor Repair Section

Replacement center trunk floor repair section for various 1962-65 B-Body models. This repair panel is manufactured from 18 gauge steel with correct contours to replace the center of any damaged trunk floor.

Note: Shipped double oversize.

MM836017	1962-64	Fury/Polara	114.99 ea
MM836017	1962-65	Belvedere	114.99 ea
MM836017	1965	Coronet	114.99 ea



1968-74 Charger Trunk Floor To Valance Braces

Rear valance braces for 1968-74 Charger models. These braces are welded to each side of the trunk floor and attach to the rear valance panel for additional support.

MM1575	1968-74		119.99 pr
--------	---------	--	-----------



MM1968

MM1970

1969-70 Charger Trunk Supports

Reproduction trunk supports for 1969-70 Charger models. These EDP coated pieces are welded to the trunk filler panel and to the outer wheelhouse panels. The upper supports also provide a mounting point for the trunk lid rods.

MM1968	1969-70	LH	upper	49.99 ea
MM1969	1969-70	RH	upper	49.99 ea
MM1970	1969-70	LH	lower	24.99 ea
MM1971	1969-70	RH	lower	24.99 ea

Trunk Lid Panels



Underside view of MM1240B



MM1242A

1968-74 Reproduction B-Body & E-Body Trunk Lids

Factory-style replacement trunk lid with spoiler mounting bracket holes for various 1968-74 models. Your choice of our Restorer's Choice panel, officially licensed by Mopar, manufactured in OE-gauge steel featuring all original contours and details or our standard replacement for the car builder on a budget. Comes finished in semi-flat black EDP coating to prevent rust and is ready to prep and paint to your desired color.

Important: Spoiler equipped trunk lids feature correct pre-cut mounting locations for the underside spoiler mounting brackets.

Note: Shipped double oversize.



Restorer's Choice

Charger			
MM1244	1968-69	without spoiler	529.99 ea
Barracuda			
MM1239	1970-74	without spoiler	499.99 ea
MM1240B	1970	with spoiler	499.99 ea
MM1241	1971	with spoiler	499.99 ea
Challenger			
MM1242B	1970-74	without spoiler	499.99 ea
MM1243	1970-71	with spoiler	499.99 ea

Standard Replacement

Barracuda			
MM1240A	1970	with spoiler	399.99 ea
Challenger			
MM1242A	1970-74	without spoiler	244.99 ea



1962-74 Trunk Lid Latch

Replacement trunk lid latch for various 1962-74 A, B-Body and Challenger models. For models without power release. Manufactured in coated metal for rust prevention and features brand new lock mechanism and latches. Will appear, fit and function as original.

MM11395 1962-74 49.99 ea



1970-74 Challenger Trunk Lid Hinges

Replacement trunk lid hinges for 1970-74 Challenger models. Hinges come EDP coated to protect against rust.

MM11839 1970-74 169.99 pr



FB2060NS

FB2060BF

1968-70 Dodge Charger Billet Trunk Hinges

Replace your original stamped steel trunk hinges with these beautiful billet aluminum hinges. Engineered for smooth, effortless operation, each hinge is machined to be not only fully functional but also visually appealing. Featuring no-modification installation, these hinges are produced using the finest quality 6061 T6 aluminum and use weatherproof bearings, gas shocks and stainless steel hardware to ensure proper operation in any climate. Available in polished, black anodized or natural finishes.

Polished Aluminum			
FB2060PF	1968-70	fiberglass trunk lid	389.99 set
FB2060PS	1968-70	steel trunk lid	389.99 set
Anodized Black			
FB2060BF	1968-70	fiberglass trunk lid	389.99 set
FB2060BS	1968-70	steel trunk lid	389.99 set
Natural Aluminum			
FB2060NF	1968-70	fiberglass trunk lid	344.99 set
FB2060NS	1968-70	steel trunk lid	344.99 set



2838620

1968-76 Trunk Lid Torque Rods

Reproduction of the trunk lid torque rods for 1968-69 Dodge B-Body and 1970-76 A-Body models. Manufactured from the correct gauge steel to factory specifications with the correct length and ends as original.

2838620	1968-69	Dodge B-Body	89.99 pr
3446880	1970-72	2 door hardtop/4 door sedan	89.99 pr
3756092	1973-76	2 door hardtop/4 door sedan	89.99 pr

New!



ME175951

1970-74 Barracuda Deck Lid Latch Links

Reproduction deck lid lock cylinder to latch links for 1970-71 Barracuda models. Features correct shape and includes the rod end clips to secure each end to the lock cylinder and deck lid latch.

ME175951	1970-71		24.99 ea
ME175952	1972-74		24.99 ea



MN1829

MN1828

MN1827

1963-74 Trunk Sliders

Replacement trunk sliders for various 1963-74 models. These pieces are installed on each end of the torque rods and come into contact with the trunk hinges.

MN1829	1963-74	A-Body, long	14.99 pr
MN1829	1963-74	B-Body, long	14.99 pr
MN1828	1970	E-Body, medium	14.99 pr
MN1827	1971-74	E-Body, short	16.99 pr

Trunk Lid Spoilers



Go Wing - profile

1968-76 Go-Wing Spoilers

Go-Wing rear spoilers for 1968-76 A, B and E-Body models. Your choice of a "Restorator's Choice" spoiler which is officially licensed by Mopar and is constructed of ABS composite, or two replacement spoilers. Aftermarket spoiler is constructed of high-density black polyethylene while the standard reproduction spoiler is made from ABS plastic and primed black. All spoilers include gaskets and mounting hardware and are made in the USA.

Note: *Shipped overseas **Shipped double overseas.

Restorator's Choice Spoilers

A-Body	1970-76	Duster/Demon/Dart Sport	419.99 set
MM1814**	1970-76	Dart 2 door hardtop	419.99 set

B-Body	1968-70	Charger	419.99 set
MM1817**	1970	Coronet, Super Bee	419.99 set
MM1818**	1970	Belvedere, GTX, Road Runner, Satellite	419.99 set
MM1820	1971-74	all models	419.99 set

E-Body	1970-74	Barracuda	419.99 set
MM1823**	1970-74 <td>Challenger</td> <th>419.99 set</th>	Challenger	419.99 set

Standard Reproduction Spoilers

A-Body	1970-76	Duster/Demon/Dart Sport	279.99 set
MM1806	1970-76 <td>Dart 2 door hardtop</td> <th>294.99 set</th>	Dart 2 door hardtop	294.99 set

B-Body	1968-70	Charger	294.99 set
MM1807	1970	Coronet, Super Bee	299.99 set
MM1808	1970	Belvedere, GTX, Road Runner, Satellite	294.99 set
MM1810	1971-74	all models	279.99 set

E-Body	1970-74	Barracuda	289.99 set
MM1812	1970-74 <td>Challenger</td> <th>299.99 set</th>	Challenger	299.99 set

Aftermarket Replacement Spoilers

A-Body	1970-76	Duster/Demon/Dart Sport	199.99 set
MM1798	1970-76 <td>Dart 2 door hardtop</td> <th>219.99 set</th>	Dart 2 door hardtop	219.99 set

B-Body	1968-70	Charger	219.99 set
MM1799	1970	Coronet, Super Bee	229.99 set
MM1800	1970	Belvedere, GTX, Road Runner, Satellite	219.99 set
MM1802	1971-74	all models	199.99 set

E-Body	1970-74	Barracuda	209.99 set
MM1804	1970-74 <td>Challenger</td> <th>299.99 set</th>	Challenger	299.99 set



1970-74 E-Body Ducktail Spoilers

Ducktail - profile

Ducktail rear spoilers for 1970-74 E-Body models. This is a "Restorator's Choice" spoiler which is officially licensed by Mopar and is constructed as original. All spoilers include gaskets and mounting hardware and are made in the USA.

Note: *Shipped double overseas.

E-Body	1970-74	AAR 'Cuda	329.99 set
MM1824	1970-74 <td>Challenger T/A</td> <th>329.99 set</th>	Challenger T/A	329.99 set



Gull Wing - profile

1971 Gull-Wing Spoilers

Gull-Wing rear spoilers for 1971 A, B and E-Body models. This is a "Restorator's Choice" spoiler which is officially licensed by Mopar and is constructed of ABS composite. All spoilers include gaskets and mounting hardware and are made in the USA.

Important: The Gull-Wing was originally offered only on 1971 models, although not cometically correct it will fit on all the years specified below.

Note: *Shipped double overseas.

A-Body	1970-74	Duster/Demon/Dart Sport	454.99 set
MM1816	1970-74 <td>Dart/Scamp</td> <th>449.99 set</th>	Dart/Scamp	449.99 set

B-Body	1971-74	all models	454.99 set
MM1821	1971-74 <td>all models</td> <th>454.99 set</th>	all models	454.99 set

E-Body	1970-74	Barracuda	454.99 set
MM1827	1970-74 <td>Challenger</td> <th>454.99 set</th>	Challenger	454.99 set



1970-71 Rear Wing Adjustment Bolts

Reproduction of the rear wing adjustment bolt set for various 1970-71 models. Manufactured to factory specifications, this three piece retainer is the piece that the wing studs thread into, and at same time secures the wing to the wing brackets. MD165509 1970-71..... 29.99 set



1970-71 Rear Spoiler Pedestal

Replace your bent, cracked spoiler pedestals instead of the entire spoiler and save money. These replacement pedestals are die cast in zinc exactly as original.

MM8289	all	64.99 ea
--------	-----	----------



1970-74 T/A Spoiler Template

If your trunk lid is not stamped with provisions for the T/A "duck tail" spoiler, use this template to duplicate the size, shape, and location of the factory cut-outs.

MM8291	all	34.99 ea
--------	-----	----------



1970-71 Trunk Lid Spoiler Reinforcement Brackets

These brackets will allow you to secure your existing spoiler, or add a new spoiler.

MM8290	all	29.99 pr
--------	-----	----------

1970 Barracuda	MM2115	39.99 pr
----------------	--------	----------



1970-71 Rear Spoiler Gaskets

Replacement rear spoiler gaskets for all 1970-71 models equipped with a factory spoiler.

MM8288	all	14.99 pr
--------	-----	----------

Trunk Lid Repair



MM1496B



MM1496A

1967-76 Trunk Gutters

Repair your rusted out trunk gutters with these all new factory style replacement trunk gutters for 1967-76 models. Your choice of our Restorer's Choice panel, officially licensed by Mopar, manufactured in OE-gauge steel featuring all original contours and details or our standard replacement for the car builder on a budget. Comes finished in black EDP coating to prevent rust and is ready to prep and paint to your desired color.

Restorer's Choice

A-Body			
MM3178	1967-69	LH	Dart - 3 piece set..... 109.99 set
MM3179	1967-69	RH	Dart - 3 piece set..... 109.99 set
MM3178	1970-76	LH	Dart/Scamp..... 109.99 set
MM3179	1970-76	RH	Dart/Scamp..... 109.99 set
MM1493	1970-76	LH	Dart Sport/Demon/Duster..... 78.99 ea
MM1494	1970-76	RH	Dart Sport/Demon/Duster..... 78.99 ea
MM1495	1970-76	LH/RH	Dart Sport/Demon/Duster..... 144.99 pr

Dodge B-Body - Charger			
MM1496B	1968-70	LH 89.99 ea
MM1497B	1968-70	RH 89.99 ea
MM1498	1968-70	LH/RH 164.99 pr
MM3175	1971-74	LH 99.99 ea
MM3176	1971-74	RH 99.99 ea

Dodge B-Body - Coronet, Super Bee			
MM1499	1968	LH	lower..... 41.99 ea
MM1500	1968	RH	lower..... 41.99 ea
MM1501	1969	LH	lower..... 44.99 ea
MM1502	1969	RH	lower..... 44.99 ea
MM1503	1968-70	LH	upper..... 64.99 ea
MM1504	1968-70	RH	upper..... 64.99 ea
MM1505	1968	LH/RH	4 piece set..... 184.99 set
MM1506	1969	LH/RH	4 piece set..... 184.99 set

Plymouth B-Body - All Models			
MM1507B	1968	LH	lower..... 44.99 ea
MM1508B	1968	RH	lower..... 44.99 ea
MM1509	1969	LH	lower..... 44.99 ea
MM1510	1969	RH	lower..... 44.99 ea
MM1775	1970	LH	lower..... 29.99 ea
MM1776	1970	RH	lower..... 29.99 ea
MM1511B	1968-70	LH	upper..... 64.99 ea
MM1512B	1968-70	RH	upper..... 64.99 ea
MM1513	1968	LH/RH	4 piece set..... 194.99 set
MM1514	1969	LH/RH	4 piece set..... 194.99 set
MM1777	1970	LH/RH	4 piece set..... 164.99 set
MM1515B	1971-74	LH 89.99 ea
MM1516B	1971-74	RH 89.99 ea
MM1517	1971-74	LH/RH 184.99 pr

E-Body - Barracuda			
MM1518B	1970-74	LH 74.99 ea
MM1519B	1970-74	RH 74.99 ea
MM1520	1970-74	LH/RH 134.99 pr

E-Body - Challenger			
MM1521B	1970-74	LH 74.99 ea
MM1522B	1970-74	RH 74.99 ea
MM1523	1970-74	LH/RH 134.99 pr

Standard Replacement

Dodge B-Body - Charger			
MM1496A	1968-70	LH 69.99 ea
MM1497A	1968-70	RH 69.99 ea

Plymouth B-Body - All Models			
MM1507A	1968	LH	lower..... 34.99 ea
MM1508A	1968	RH	lower..... 34.99 ea
MM1511A	1968-70	LH	upper..... 49.99 ea
MM1512A	1968-70	RH	upper..... 49.99 ea
MM1515A	1971-74	LH 64.99 ea
MM1516A	1971-74	RH 64.99 ea

E-Body - Barracuda			
MM1518A	1970-74	LH 59.99 ea
MM1519A	1970-74	RH 59.99 ea

E-Body - Challenger			
MM1521A	1970-74	LH 59.99 ea
MM1522A	1970-74	RH 59.99 ea



MM1231



MM1232



MM1235



MM1236



MM1233B



MM1234

1968-74 Trunk Lock Supports

Factory-style replacement trunk lock support. A must for any trunk area restoration, this support mounts between the trunk floor and tail panel and acts as a brace for the tail panel as well as the trunk latch assembly. Your choice of our Restorer's Choice panel, officially licensed by Mopar, manufactured in OE-gauge steel featuring all original contours and details or our standard replacement for the car builder on a budget. Comes finished in black EDP coating to prevent rust.

Restorer's Choice

A-Body			
MM1231	1970-73	Dart 74.99 ea
MM1232	1970-73	Dart Sport, Demon, Duster 74.99 ea

Dodge B-Body			
MM1235	1969	Coronet, Super Bee 94.99 ea
MM1236	1968-70	Charger 94.99 ea

Plymouth B-Body			
MM1233B	1968-69	all models 59.99 ea
MM1234	1970	all models 94.99 ea

E-Body			
MM1237B	1970-74	Barracuda 79.99 ea

Standard Replacement

Plymouth B-Body			
MM1233A	1968-69	all models 49.99 ea

E-Body			
MM1237A	1970-74	Barracuda 64.99 ea
MM1238	1970-74	Challenger 49.99 ea



1970-71 Barracuda Trunk Lock Shield

Replacement trunk lock shield for 1970-71 Barracuda models. This panel protects the trunk lock rod. Replace your damaged or missing original with this quality stamped steel replacement.

MM1552	1970-71 69.99 ea
--------	---------	----------------

Trunk Components

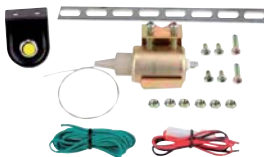

Power Trunk Lock Conversion

This set is designed to convert your vehicles manual trunk lock to power release. A great addition when installing power door locks or a keyless entry system. Includes actuator, push button, brackets and wiring.

PTL1001 universal..... 24.99 set

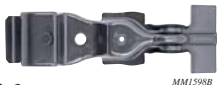

MM1598B



MM1601



MM1602A

1962-74 Spare Tire Hold Down Bracket

Factory style replacement spare tire hold down bracket for 1962-74 models. This is the bracket that secures the spare tire to the trunk floor. Your choice of our Restorer's Choice bracket, officially licensed by Mopar, manufactured in OE-gauge steel featuring all original contours and details or our standard replacement for the car builder on a budget. Comes finished in black EDP coating to prevent rust.

Restorer's Choice

B-Body	
MM1597	1962-65 all hold-down bracket 39.99 ea
MM1764	1966-67 all hold-down bracket 21.99 ea
MM1598B	1968 all hold-down bracket 39.99 ea
MM1599	1969-70 all hold-down bracket 39.99 ea
MM1600	1971-72 all hold-down bracket 21.99 ea
MM1601	1968-74 Charger spare support 54.99 pr

E-Body	
MM1602B	1970-74 hardtop hold-down bracket 34.99 ea
MM1603	1970-71 convertible hold-down bracket 44.99 ea

Standard Replacement

B-Body	
MM1598A	1968 all hold-down bracket 29.99 ea

E-Body	
MM1602A	1970-74 hardtop hold-down bracket 26.99 ea



1963-68 Spare Tire Wing Nut

Reproduction wing nut used to secure the spare tire in the trunk of all 1963-68 models. Manufactured as original.

6023540 1963-68..... 9.99 ea

New!



MM1613

1968-74 B & E-Body Spare Tire Mounting Hardware

Replacement spare tire mounting stud and nut for various 1968-74 models. Replace your missing or damaged hardware with this set which includes the correct stud and nut.

B-Body	
MB12060	1968 all 29.99 set
MM1609	1969-74 hardtop with 70 or 78 series spare 29.99 set
MM1610	1969-74 convertible with 70 or 78 series spare 29.99 set
MM1611	1971-74 all with 60 series spare 29.99 set

E-Body	
MM1612	1970-74 all with full size spare 29.99 set
MM1613	1970-74 all with space saver spare 29.99 set



MM1605



MM1606



MM1607

1967-74 Jack Mounting Hardware

Jack mounting hardware for various 1967-76 models. Replace damaged or missing original hardware with these quality replacements for a factory original fit and appearance.

A-Body	
MM3080	1967-76 all upper jack bracket 29.99 ea

B-Body	
MM1604	1968-70 all hold down assembly 24.99 ea
MM1605	1971-73 all jack bracket 29.99 pr
MM1606	1968-70 Charger L.H spring hook 17.99 ea
MM1607	1968-70 Charger L.H bracket 19.99 ea

E-Body	
MM1606	1970-74 all L.H spring hook 17.99 ea
MM1607	1970-74 all L.H bracket 19.99 ea
MM7907	1970-74 all 3 piece spring and brackets set... 69.99 set



MM1561B



MM8297



MM8296

1970-74 E-Body Rear Floor Pan Braces

Factory-style replacement rear floor pan braces for the 1970-74 Mopar E-Body models. This brace is installed by welding it onto each side of the trunk to the rear of the quarter panel. Your choice of our Restorer's Choice brace, officially licensed by Mopar, manufactured in OE-gauge steel featuring all original contours and details or our standard replacement for the car builder on a budget.

Restorer's Choice

MM1561B 1970-74 LH/RH - pair 44.99 pr

Standard Replacement

MM8296	1970-74 LH 22.99 ea
MM8297	1970-74 RH 22.99 ea

Trunk Components

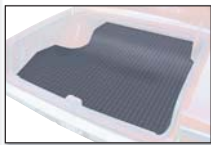

Replacement Trunk Mats

Bring your trunk compartment back to showroom condition with a replacement trunk mat. Each mat is precision die-cut to original specifications to fit your trunk compartment perfectly. We offer your choice of an economical fleece-backed vinyl mat or an original style rubber mat in a variety of printed patterns including gray herringbone, gray houndstooth or gray plaid. Please specify material pattern when ordering. Made in USA.



herringbone houndstooth plaid

1960-76 A-Body Trunk Mats

Fleece Backed Vinyl Trunk Mats

Barracluda			
MA792	1967-69	fastback	29.99 ea
MA793	1967-69	notchback coupe	29.99 ea
Dart			
MA782	1963-66	2 door hardtop	29.99 ea
MA783	1963-66	convertible	34.99 ea
MA784	1967-69	2 door hardtop	29.99 ea
MA785	1967-69	convertible	29.99 ea
MA786	1970-73	2 door hardtop	29.99 ea
MA787	1974-76	2 door hardtop	29.99 ea
Demon, Dart Sport			
MA788	1971-76	2 door coupe	29.99 ea
Duster			
MA788	1970-76	2 door coupe	29.99 ea
Lancer			
MA780	1960-62	all	34.99 ea
Scamp			
MA786	1971-73	2 door hardtop	29.99 ea
MA787	1974-76	2 door hardtop	29.99 ea
Valiant			
MA780	1960-62	all	34.99 ea
MA790	1963-66	2 door hardtop	29.99 ea
MA791	1970-73	4 door sedan	39.99 ea

Rubber Trunk Mats

Barracluda			
MA806	1967-69	fastback	49.99 ea
MA807	1967-69	notchback coupe	49.99 ea
Dart			
MA795	1963-66	2 door hardtop	49.99 ea
MA796	1963-66	convertible	49.99 ea
MA797	1967-69	2 door hardtop	49.99 ea
MA798	1967-69	convertible	49.99 ea
MA799	1970-73	2 door hardtop	49.99 ea
MA801	1974-76	2 door hardtop	49.99 ea
Demon, Dart Sport			
MA801	1971-76	2 door coupe	49.99 ea
Duster			
MA801	1970-76	2 door coupe	49.99 ea
Lancer			
MA803	1960-62	all	49.99 ea
Scamp			
MA799	1971-73	2 door hardtop	49.99 ea
MA801	1974-76	2 door hardtop	49.99 ea
Valiant			
MA803	1960-62	all	49.99 ea
MA804	1963-66	2 door hardtop	49.99 ea
MA805	1970-73	4 door sedan	62.99 ea



herringbone houndstooth plaid

1962-69 B-Body Fleece Backed Vinyl Mats

Belvedere			
MB406	1962	2 door hardtop	34.99 ea
MB407	1963	2 door hardtop	34.99 ea
MB408	1964-65	2 door hardtop	34.99 ea
Charger			
MB409	1968-69	2 door hardtop	34.99 ea
Coronet			
MB410	1962-65	2 door hardtop	34.99 ea
MB411	1965	convertible	41.99 ea
MB412	1966-67	2 door hardtop	34.99 ea
MB413	1966-67	convertible	34.99 ea
MB414	1968-69	2 door hardtop	34.99 ea
MB415	1968-69	convertible	34.99 ea
Fury, Sport Fury			
MB416	1962	2 door hardtop	34.99 ea
MB417	1962	convertible	34.99 ea
MB418	1963	2 door hardtop	34.99 ea
MB419	1963	convertible	34.99 ea
MB420	1964	2 door hardtop	34.99 ea
MB421	1964	convertible	34.99 ea
GTx			
MB412	1967	2 door hardtop	34.99 ea
MB422	1967	convertible	34.99 ea
MB423	1968-69	2 door hardtop	34.99 ea
MB424	1968-69	convertible	34.99 ea
Road Runner			
MB423	1968-69	2 door hardtop	34.99 ea
MB424	1969	convertible	34.99 ea
Satellite			
MB579	1965	2 door hardtop	64.99 ea
MB426	1965	convertible	34.99 ea
MB412	1966-67	2 door hardtop	34.99 ea
MB422	1966-67	convertible	34.99 ea
MB423	1968-69	2 door hardtop	34.99 ea
MB424	1968-69	convertible	34.99 ea
Super Bee			
MB414	1968-69	2 door hardtop	34.99 ea



herringbone

1970-74 B-Body Fleece Backed Vinyl Mats

Charger			
MB409HB	1970	2 door hardtop	34.99 ea
MB427HB	1971-74	2 door hardtop	29.99 ea
MB427HB	1974	with raised floor	29.99 ea
Coronet			
MB430HB	1970	2 door hardtop	29.99 ea
MB430HB	1970	convertible	29.99 ea
GTx			
MB431HB	1970	2 door hardtop	29.99 ea
MB432HB	1971	2 door hardtop	29.99 ea
Road Runner			
MB431HB	1970	2 door hardtop	29.99 ea
MB432HB	1971-74	2 door hardtop	29.99 ea
Satellite			
MB431HB	1970	2 door hardtop	29.99 ea
MB433HB	1970	convertible	29.99 ea
MB432HB	1971-74	2 door hardtop	29.99 ea
Super Bee			
MB429HB	1970	2 door hardtop	29.99 ea
MB432HB	1971-74	2 door hardtop	29.99 ea



herringbone

1970-74 E-Body Fleece Backed Vinyl Mats

Barracluda, Cuda			
ME1500HB	1970-74	vinyl	29.99 ea
Challenger			
ME1501HB	1970-74	vinyl	29.99 ea



herringbone houndstooth plaid

1962-69 B-Body Rubber Trunk Mats

Belvedere			
MB577	1962	2 door hardtop	64.99 ea
MB578	1963	2 door hardtop	64.99 ea
MB579	1964-65	2 door hardtop	64.99 ea
Charger			
MB580	1968-69	2 door hardtop	64.99 ea
Coronet			
MB581	1962-65	2 door hardtop	59.99 ea
MB582	1965	convertible	59.99 ea
MB583	1966-67	2 door hardtop	64.99 ea
MB584	1966-67	convertible	59.99 ea
MB585	1968-69	2 door hardtop	59.99 ea
MB586	1968-69	convertible	59.99 ea
Fury, Sport Fury			
MB587	1962	2 door hardtop	64.99 ea
MB588	1962	convertible	64.99 ea
MB589	1963	2 door hardtop	64.99 ea
MB590	1963	convertible	64.99 ea
MB591	1964	2 door hardtop	64.99 ea
MB592	1964	convertible	39.99 ea
GTx			
MB583	1967	2 door hardtop	64.99 ea
MB593	1967	convertible	59.99 ea
MB594	1968-69	2 door hardtop	64.99 ea
MB595	1968-69	convertible	49.99 ea
Road Runner			
MB594	1968-69	2 door hardtop	64.99 ea
MB595	1969	convertible	49.99 ea
Satellite			
MB579	1965	2 door hardtop	64.99 ea
MB596	1965	convertible	64.99 ea
MB583	1966-67	2 door hardtop	64.99 ea
MB593	1966-67	convertible	59.99 ea
MB594	1968-69	2 door hardtop	64.99 ea
MB595	1968-69	convertible	49.99 ea
Super Bee			
MB585	1968-69	2 door hardtop	59.99 ea



herringbone

1970-74 B-Body Rubber Trunk Mats

Charger			
MB580HB	1970	2 door hardtop	64.99 ea
MB400HB	1971-74	2 door hardtop	54.99 ea
MB405HB	1974	with raised floor	54.99 ea
Coronet			
MB401HB	1970	2 door hardtop	54.99 ea
MB402HB	1970	convertible	49.99 ea
GTx			
MB403HB	1970	2 door hardtop	54.99 ea
MB400HB	1971	2 door hardtop	54.99 ea
Road Runner			
MB403HB	1970	2 door hardtop	54.99 ea
MB400HB	1971-74	2 door hardtop	54.99 ea
Satellite			
MB403HB	1970	2 door hardtop	54.99 ea
MB404HB	1970	convertible	54.99 ea
MB400HB	1971-74	2 door hardtop	54.99 ea
Super Bee			
MB401HB	1970	2 door hardtop	54.99 ea
MB400HB	1971-74	2 door hardtop	54.99 ea



herringbone

1970-74 E-Body Rubber Trunk Mats

Barracluda, Cuda			
ME1498HB	1970-74	rubber	51.99 ea
Challenger			
ME1499HB	1970-74	rubber	49.99 ea

Trunk Components



houndstooth

plaid



MB452

1963-65 B-Body Molded Trunk Mats

Consider your trunk compartment an important aspect of your rebuild and bring it back to showroom condition with a replacement molded trunk mat. Each mat is precision die-cut, then vacuum formed to fit your trunk pan perfectly. A variety of applications are available in gray houndstooth or gray plaid patterns. Made in USA.

Belvedere	
MB451PL 1963-65 gray plaid.....	109.99 ea
Coronet	
MB452PL 1965 gray plaid.....	109.99 ea
Sport Fury	
MB453HT 1963 gray houndstooth ...	109.99 ea



MB436HB



herringbone

1971-74 B-Body Trunk Mat & Board Set

Help your trunk area look like it's fresh off the showroom floor with this trunk renewal kit. Each kit includes a new OE style trunk mat, a precision die-cut black fiberboard spare tire panel and trunk side panels in herringbone pattern. Available for a variety of B-Body vehicles including Charger SE, GTX, Satellite and Road Runner. Made in USA.

Charger SE	
MB435HB 1971-74 trunk resto kit.....	114.99 set
GTX, Satellite, Road Runner	
MB436HB 1971-74 trunk resto kit.....	114.99 set



MD4050



Spare Tire Covers

Add the finishing touch to your trunk compartment with a spare tire cover to match your trunk mat. Made from fleecy-backed vinyl material in your choice of herringbone, houndstooth or plaid print, these universal fit covers are designed to fit any floor mounted spare. Made in USA.

14" Spare Tire Cover	
MD4046 herringbone pattern.....	39.99 ea
MD4047 houndstooth pattern.....	39.99 ea
MD4048 plaid pattern.....	39.99 ea
15" Spare Tire Cover	
MD4049 herringbone pattern.....	39.99 ea
MD4050 houndstooth pattern.....	39.99 ea
MD4051 plaid pattern.....	39.99 ea



MD450



MB449

1962-65 Trunk Floor Filler Boards

Each 2 piece fiberboard panel is precision die-cut to original specifications to fill in the area between the outer edges of the trunk floor and the inner quarter panels. Made in USA.

B-Body	
Dodge 440, Polara, Polara 500	
MB445 1962 2 dr hdp, convertible ...	19.99 pr
MB446 1963 2 dr hdp, convertible ...	19.99 pr
MB447 1964 2 dr hdp, convertible ...	19.99 pr
Belvedere, Satellite	
MB448 1963-65 2 dr hdp, convertible ...	29.99 pr
Fury, Sport Fury	
MB449 1963-64 2 dr hdp, convertible ...	29.99 pr
Coronet	
MB450 1965 2 dr hdp, convertible ...	19.99 pr



MB444



1962-74 Trunk Side Panel Boards

Trunk side panel boards. Each black fiberboard panel set is precision die-cut to original specifications and conceals the inner quarter panels exactly as original. Made in USA.

A-Body	
Designed to fit 1973-74 Dart Sport with "Convertipl" fold down rear seat or 1973-74 Duster with "Space Duster" fold down rear seat option.	
Dart Sport, Duster	
MA811 1973-74 3 piece set.....	49.99 set

B-Body	
Dodge 440, Polara, Polara 500	
MB437 1962 convertible, 4 pc set	99.99 set
MB438 1963 2 dr hardtop, 4 pc set	99.99 set
MB439 1963 convertible, 4 pc set	99.99 set
Fury & Sport Fury	
MB440 1962 2 dr hardtop, 4 pc set	99.99 set
MB441 1962 convertible, 4 pc set	99.99 set
MB442 1963 2 dr hardtop, 4 pc set	99.99 set
MB443 1963 convertible, 4 pc set	99.99 set
Charger	
MB444 1966-67 fastback, 5 pc set.....	99.99 set



MB344



1963-76 Spare Tire Well Board

Each black fiberboard well board is precision die-cut to original specifications to fit beneath the trunk mat and cover the spare tire well exactly as original. Made in USA.

A-Body	
Dart, Dart Sport, Demon, Duster, Scamp	
MA808 1963-64 spare tire well board.....	19.99 ea
MA809 1965-76 spare tire well board.....	19.99 ea
Valiant	
MA810 1963-64 spare tire well board.....	19.99 ea

B-Body	
All Models	
MB334 1966-67 spare tire well board.....	19.99 ea



OER® Trunk Refinish Kit

Spatter painting provides an economic alternative to painting your trunk the factory body color and will dramatically improve the appearance of your trunk area with the added benefit of protection from the elements. So if you're looking for a custom look in your trunk compartment, our trunk refinsh kit is just the thing for you. Includes primer, base coat, spatter coat and clear topcoat.

Note: Ships ground only. No air shipment.



black/gray

black/aqua

gray/white

Complete Trunk Refinishing Kit

This kit contains 2 cans of primer, 3 cans of spatter paint and 2 cans of clear topcoat.

with Standard Gray Primer	
K51490 black and gray.....	104.99 kit
K51491 black and aqua.....	104.99 kit
K51492 gray and white.....	104.99 kit
with Self Etching Gray Primer	
K51493 black and gray.....	104.99 kit
K51494 black and aqua.....	104.99 kit
K51495 gray and white.....	104.99 kit

Trunk Refinishing Components

Need an extra can of a trunk refinishing component?	
Primer Only - 20 oz. Cans	
K89576 standard gray primer.....	12.99 ea
K89560 self etching gray.....	12.99 ea
Base Coat Only - 20 oz. Cans	
K89578 flat black.....	12.99 ea
K89581 dark gray.....	12.99 ea
Spatter Coat Only - 16 oz. Cans	
K51496 black and gray.....	12.99 ea
K51499 black and aqua.....	12.99 ea
K51498 gray and white.....	12.99 ea
Clear Topcoat Only - 16 oz. Cans	
K51497 clear topcoat.....	12.99 ea

Rear Body Panels



New!



MM1285



MM1286



MM1299



MM1300



MM1294



MM1295B



MM1298B



1968-74 Tail Panels

Factory style replacement tail lamp panel for various 1968-74 Dodge and Plymouth models. Your choice of our Restorer's Choice panel, officially licensed by Mopar, manufactured in OE-gauge steel featuring all original contours and details or our standard replacement for the car builder on a budget. Comes finished in black EDP coating to prevent rust and is ready to prep and paint your desired color.

Note: Shipped oversize.

Restorer's Choice

A-Body	1970-71	Duster	314.99 ea
MM1285	1970-71	Duster	314.99 ea
MM1286	1972	Duster	314.99 ea
MM1299	1971-72	Demon	319.99 ea

Dodge B-Body

MM1300	1968	Charger	408.99 ea
MM1301	1969-70	Charger	429.99 ea
MM1302	1969	Coronet	408.99 ea

Plymouth B-Body

MM1294	1970	all models	424.99 ea
--------	------	------------	-----------

E-Body

MM1295B	1970-71	Barracuda	409.99 ea
MM1296	1972	Barracuda	404.99 ea
MM1297	1973-74	Barracuda	404.99 ea
MM1298B	1970	Challenger	444.99 ea

Standard Replacement

MM1295A	1970-71	Barracuda	319.99 ea
MM1298A	1970	Challenger	359.99 ea



MM1288

MM1289



MM1292

1968-69 Rear Tail Lamp Panels

Reproduction rear body panels for various 1968-69 models. Each stamped steel panel features correct contours and comes EDP coated to prevent rust.

Note: Shipped oversize.

Dodge Dart

MAR22052	1968-69	LH - tail lamp panel	69.99 ea
MAR22053	1968-69	RH - tail lamp panel	69.99 ea
MAR22054*	1968-69	outer lower	149.99 ea
MAR22055*	1968-69	inner lower	149.99 ea

Plymouth B-Body

MM1288	1968	LH, tail lamp panel	64.99 ea
MM1289	1968	RH, tail lamp panel	64.99 ea
MM1292*	1968	lower panel	179.99 ea
MM1290	1969	LH, tail lamp panel	64.99 ea
MM1291	1969	RH, tail lamp panel	64.99 ea
MM1293*	1969	lower panel	179.99 ea



MM1305

MM1306

1970-72 A-Body Tail Lamp Brackets

Replacement tail lamp brackets for 1970-72 Duster and Demon models. This bracket is welded to the rear tail panel and provides support for the tail lamps.

MM1303	1970-71	LH, Duster	78.99 ea
MM1304	1970-71	RH, Duster	78.99 ea
MM1305	1972	LH, Duster	78.99 ea
MM1306	1972	RH, Duster	78.99 ea
MM1303	1971-72	LH, Demon	78.99 ea
MM1304	1971-72	RH, Demon	78.99 ea

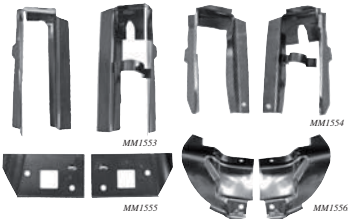

MM1553

MM1554

MM1555

MM1556B

1967-76 Tail Lamp Reinforcement Brackets

Tail lamp reinforcement brackets for various 1967-76 models. Welded to the tail lamp panel to provide additional support. Designed using factory specifications, each bracket will replace the original exactly.

MM1553	1967-69	Dart	59.99 pr
MM1554	1970-76	Dart Sport/Demon/Duster	59.99 pr
MM1555	1969-70	Charger	44.99 pr
MM1556B	1970-74	Barracuda	89.99 pr

Rear Body Panels

New!

1967-74 Rear Valance Panels



Factory-style replacement rear valance panels for various 1967-74 models. This panel mounts below the rear bumper. Valance panels are commonly damaged when backing up in parking lots and often bear scars of parking lot hazards over the years. Enhance the appearance of your restoration by replacing it. Your choice of our Restorer's Choice panel, officially licensed by Mopar, manufactured in OE-gauge steel featuring all original contours and details or our standard replacement for the car builder on a budget. Comes finished in black EDP coating to note: Shipped double oversize.

Notes: Shipped double oversize.

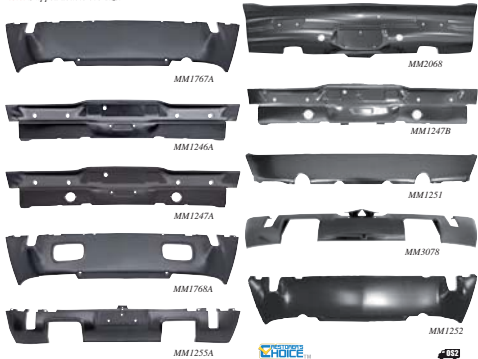

Standard Replacement

B-Body - Charger	
MM1246A	1968 without light holes..... 179.99 ea
MM1247A	1969-70 with light holes..... 179.99 ea
E-Body - Barracuda	
MM1767A	1973-74 without exhaust tips..... 189.99 ea
MM1768A	1973-74 with exhaust tips..... 189.99 ea
Challenger	
MM1254A	1970-71 without exhaust tips..... 179.99 ea
MM1255A	1970-71 with exhaust tips..... 179.99 ea

Restorer's Choice

A-Body - Dart/Scamp	
MM3177	1970-72 Dart/Scamp..... 218.99 ea
A-Body - Barracuda	
MM2067	1967-69 without exhaust tips..... 224.99 ea
MM2068	1968-69 with exhaust tips..... 224.99 ea
B-Body - Dodge	
MB280986B	1963 all..... 289.99 ea
B-Body - Charger	
MM1246B	1968 without light holes..... 224.99 ea
MM1247B	1969-70 with light holes..... 224.99 ea
MM1248	1971-72 without exhaust tips..... 224.99 ea
MM3173	1971-72 with exhaust tips..... 259.99 ea
MM1249	1973-74 without exhaust tips..... 224.99 ea
MM3174	1973-74 with exhaust tips..... 259.99 ea
B-Body - Road Runner	
MM1250	1971 without exhaust tips..... 224.99 ea
MM1251	1971 with exhaust tips..... 224.99 ea
E-Body - Barracuda	
MM1252	1970 without exhaust tips..... 229.99 ea
MM1253	1970 with exhaust tips..... 229.99 ea
MM1765	1971-72 without exhaust tips..... 239.99 ea
MM1766	1971-72 with exhaust tips..... 239.99 ea
MM1767B	1973-74 without exhaust tips..... 239.99 ea
MM1768B	1973-74 with exhaust tips..... 239.99 ea
E-Body - Challenger	
MM1254B	1970-71 without exhaust tips..... 224.99 ea
MM1255B	1970-71 with exhaust tips..... 224.99 ea
MM3077	1972-74 without exhaust tips..... 224.99 ea
MM3078	1972-74 with exhaust tips..... 224.99 ea

New!



MM2883

1970-74 Rear Valance Hardware Sets

Reproduction front valance panel hardware sets for various 1970-74 models. Manufactured to factory specifications every set includes all the necessary hardware to mount the rear valance.

MM2883	1971 Plymouth B-Body.....	21.99 set
MM2884	1970-71 E-Body.....	22.99 set
MM2885	1972-74 E-Body.....	22.99 set



MM1444

1970-74 E-Body Rear Valance Brackets

Rear valance panel brackets for 1970-74 E-Body models. These brackets secure the rear valance to the rear crossrail. Designed using factory specifications, each bracket will fit and install exactly as original.

MM1442	1970 Barracuda.....	94.99 pr
MM1443	1970-74 Barracuda.....	29.99 pr
MM1444	1970-71 Challenger.....	94.99 pr

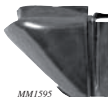

MM1595

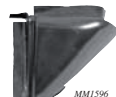

MM1596

1968-70 Charger Rear Lower Panels

Reproduction rear lower corner panels for 1968-70 Charger models. Features correct gauge sheet metal and comes EDP coated to prevent rust. This panel is installed between the quarter panel and the rear lower valance panel.

MM1595	1968-70 LH.....	69.99 ea
MM1596	1968-70 RH.....	69.99 ea

Frame Rail Repair



MB1866

ME5046

1966-74 Front Frame Rails

Replacement front frame rails for various 1966-70 B-Body and 1970-74 E-Body models. Feature correct contours, and are finished off with an EDP coating.

Note: Shipped oversize.

MB1866	1966-70	LH	B-Body	419.99 ea
MB1867	1966-70	RH	B-Body	419.99 ea
ME5046A	1970-74	LH	E-Body	374.99 ea
ME5047A	1970-74	RH	E-Body	374.99 ea



MM1901

1970-74 E-Body Front Rail/Shock Mount Set

Reproduction front frame rail and upper control arm set for 1970-74 E-Body models. Manufactured to factory specifications and EDP coated for rust protection.

Note: Shipped double oversize.

MM1901	1970-74	LH	409.99 set
MM1902	1970-74	RH	409.99 set



MMS184



MMS144

1960-76 Upper Control Arm Mount

If you are unable to maintain proper front end alignment, check the mounting points for your suspension. This is a direct replacement for the control arm mount located in the "horseshoe," and tends to deteriorate on cars that have been parked for long periods on time.

A-Body

MMS184	1960-76	LH	199.99 ea
MMS185	1960-76	RH	199.99 ea
MMS186	1960-76	LH & RH	350.99 pr

B-Body

MMS089	1966-70	LH	74.99 ea
MMS090	1966-70	RH	69.99 ea
MMS091	1966-70	LH & RH	125.99 pr

E-Body

MMS144	1970-74	LH	74.99 ea
MMS331	1970-74	RH	74.99 ea



MD2594



MM1907

1962-74 Shock and Control Arm Reinforcements

Replacement shock tower braces and control arm reinforcement brackets for 1962-74 B & E-Body models. The control arm reinforcement attaches from the upper control arm bracket to the fender shield. Both are EDP coated for rust prevention.

Shock Tower Braces

MD2593	1962-74	LH	B-Body	94.99 ea
MD2594	1962-74	RH	B-Body	94.99 ea
MD2593	1970-74	LH	E-Body	94.99 ea
MD2594	1970-74	RH	E-Body	94.99 ea

Control Arm Braces

MM1907	1970-74	LH	E-Body	29.99 ea
MM1908	1970-74	RH	E-Body	29.99 ea



MMS138



1962-76 Subframe Connectors

Connect the front and rear subframes together for added structural rigidity. The factory engineers requested these, but the bean counters ruled them out. These are a popular addition to high-performance cars and are a must have on convertibles. These subframe connectors work in conjunction with torque boxes.

MM8187	1966-76	A-Body	149.99 pr
MM8052	1962-65	B-Body	149.99 pr
MM8050	1966-70	B-Body	139.99 pr
MM8051	1971-72	B-Body	124.99 pr
MM8138	1970-74	Barracuda	139.99 pr
MM8139	1970-74	Challenger	139.99 pr

New!



MM1416B



1968-74 Full Rear Frame Rails

Maintain the structural integrity of your 1967-76 Mopar by installing new factory-style replacement frame rails to replace damaged or rusted original frame rails. Each frame rail covers the entire trunk area from the front to rear tail panel. Your choice of our Restorer's Choice panel, officially licensed by Mopar, manufactured in OE-gauge steel featuring all original contours and details or our standard replacement for the car builder on a budget. For 2 door models only. Comes finished in black EDP coating to prevent rust.

Note: Shipped double oversize.

Restorer's Choice

A-Body				
MA688015	1967-76	LH	379.99 ea	
MA688016	1967-76	RH	379.99 ea	
B-Body				
MM1416B	1968-70	LH	394.99 ea	
MM1417B	1968-70	RH	394.99 ea	
E-Body				
MM1418B	1970-74	LH	379.99 ea	
MM1419B	1970-74	RH	379.99 ea	

Standard Replacement

B-Body				
MM1416A	1968-70	LH	314.99 ea	
MM1417A	1968-70	RH	314.99 ea	
E-Body				
MM1418A	1970-74	LH	294.99 ea	
MM1419A	1970-74	RH	294.99 ea	

Frame Rail Repair

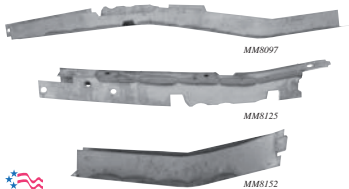

1960-76 Front Frame Rail Caps

Repair your frame rail rust economically with Safe-T-Caps in full length or partial lengths. Full length cap repairs the frame rail from the radiator core support to the torsion bar cross member. Front section cap repairs the frame from the core support to the firewall, while the rear section repairs the frame from the firewall to the torsion bar cross member. All caps are made in the USA.

Full Front Frame Rail Caps

A-Body	
MM8157	1960-76 LH..... 279.99 ea
MM8158	1960-76 RH..... 279.99 ea
MM8159	1960-76 LH & RH..... 549.99 pr

B-Body	
MM8053	1962-65 LH..... 259.99 ea
MM8326	1962-65 RH..... 259.99 ea
MM8054	1962-65 LH & RH..... 449.99 pr
MM8055	1966-70 LH..... 279.99 ea
MM8327	1966-70 RH..... 279.99 ea
MM8056	1966-70 LH & RH..... 467.99 pr
MM8057	1971-72 LH..... 259.99 ea
MM8328	1971-72 RH..... 259.99 ea
MM8058	1971-72 LH & RH..... 449.99 pr
MM8059	1973-74 LH..... 299.99 ea
MM8329	1973-74 RH..... 299.99 ea
MM8060	1973-74 LH & RH..... 503.99 pr

E-Body	
MM8097	1970-74 LH..... 279.99 ea
MM8098	1970-74 RH..... 279.99 ea
MM8099	1970-74 LH & RH..... 569.99 pr

Front Section Caps

A-Body	
MM8154	1960-76 LH..... 184.99 ea
MM8155	1960-76 RH..... 169.99 ea
MM8156	1960-76 LH & RH..... 329.99 pr

B-Body	
MM8067	1962-65 LH..... 179.99 ea
MM8068	1962-65 RH..... 179.99 ea
MM8069	1962-65 LH & RH..... 323.99 pr
MM8070	1966-70 LH..... 184.99 ea
MM8071	1966-70 RH..... 184.99 ea
MM8072	1966-70 LH & RH..... 314.99 pr

E-Body	
MM8124	1970-74 LH..... 189.99 ea
MM8125	1970-74 RH..... 189.99 ea
MM8126	1970-74 LH & RH..... 389.99 pr

Rear Section Caps

A-Body	
MM8151	1960-76 LH..... 149.99 ea
MM8152	1960-76 RH..... 149.99 ea
MM8153	1970-74 LH & RH..... 309.99 pr

B-Body	
MM8073	1966-70 LH..... 134.99 ea
MM8074	1966-70 RH..... 134.99 ea
MM8075	1966-70 LH & RH..... 233.99 pr
MM8076	1971-72 LH..... 134.99 ea
MM8077	1971-72 RH..... 134.99 ea
MM8078	1971-72 LH & RH..... 233.99 pr

E-Body	
MM8103	1970-74 LH..... 149.99 ea
MM8104	1970-74 RH..... 149.99 ea
MM8105	1970-74 LH & RH..... 299.99 pr



1960-76 Rear Frame Rail Caps

Repair your frame rail rust economically with Safe-T-Caps in full length or partial lengths. Full length cap repairs the frame rail from the forward leaf spring mount to the rear cross member. Front section cap repairs the frame from the forward leaf spring mount to above the rear axle, while the rear section repairs the frame from the shock cross member to the rear cross member. All caps are made in the USA.

Note: *Shipped double overcast.

Full Rear Frame Rail Caps

A-Body	
MM8160*	1960-76 LH..... 299.99 ea
MM8161*	1960-76 RH..... 299.99 ea
MM8162*	1960-76 LH & RH..... 561.99 pr

B-Body	
MM8044*	1966-70 LH..... 299.99 ea
MM8045*	1966-70 RH..... 299.99 ea
MM8046*	1966-70 LH & RH..... 467.99 pr
MM8047*	1971-72 LH..... 259.99 ea
MM8048*	1971-72 RH..... 259.99 ea
MM8049*	1971-72 LH & RH..... 467.99 pr

E-Body	
MM8100*	1970-74 LH..... 274.99 ea
MM8101*	1970-74 RH..... 259.99 ea
MM8102*	1970-74 LH & RH..... 589.99 pr

Front Section Caps

A-Body	
MM8163	1960-76 LH..... 184.99 ea
MM8164	1960-76 RH..... 184.99 ea
MM8165	1960-76 LH & RH..... 305.99 pr

B-Body	
MM8041	1966-70 LH..... 184.99 ea
MM8042	1966-70 RH..... 184.99 ea
MM8043	1966-70 LH & RH..... 305.99 pr

E-Body	
MM8133	1970-74 LH..... 184.99 ea
MM8134	1970-74 RH..... 184.99 ea
MM8135	1970-74 LH & RH..... 379.99 pr

Rear Section Caps

B-Body	
MM8079	1966-70 LH..... 184.99 ea
MM8080	1966-70 RH..... 184.99 ea
MM8081	1966-70 LH & RH..... 314.99 pr

E-Body	
MM8082	1971-72 LH..... 169.99 ea
MM8083	1971-72 RH..... 169.99 ea
MM8084	1971-72 LH & RH..... 287.99 pr

E-Body	
MM8127	1970-74 LH..... 189.99 ea
MM8128	1970-74 RH..... 189.99 ea
MM8129	1970-74 LH & RH..... 389.99 pr



MM8061



MM8064

1966-74 B & E-Body Subframe T-Cap

The ends of the torsion bar cross members often rust out next to the inner rocker. These T-caps reinforce the weakened intersection on the underside. Made in USA.

B-Body	
MM8061	1966-70 LH..... 134.99 ea
MM8062	1966-70 RH..... 129.99 ea
MM8063	1966-70 LH & RH..... 215.99 pr
MM8064	1971-72 LH..... 119.99 ea
MM8065	1971-72 RH..... 119.99 ea
MM8066	1971-72 LH & RH..... 215.99 pr

E-Body	
MM8106	1970-74 LH..... 129.99 ea
MM8107	1970-74 RH..... 129.99 ea
MM8108	1970-74 LH & RH..... 239.99 pr

Rocker Repair Panels

New!



MM1412A



1966-76 Leaf Spring Mounts

Factory-style replacement leaf spring shackle perch for various 1966-76 models. The front mounts are welded to the rear frame rail and to the rear toe board. Your choice of our Restorer's Choice mount, officially licensed by Mopar, manufactured in OE-gauge steel featuring all original contours and details or our standard replacement for the car builder on a budget. Comes finished in black EDP coating to prevent rust. Note: *Plymouth only. †Dodge only.

Restorer's Choice

A-Body	Year	Side	Price
MA822082	1967-76	LH front	54.99 ea
MA822083	1967-76	RH front	54.99 ea
MM1762	1967-76	LH rear	38.99 ea
MM1763	1967-76	RH rear	38.99 ea

B-Body	Year	Side	Price
MM1410B	1966-70	LH front	114.99 ea
MM1411B	1966-70	RH front	114.99 ea
MM1412B*	1966-70	LH rear	114.99 ea
MM1413B*	1966-70	RH rear	114.99 ea
MM1936†	1966-70	LH rear	114.99 ea
MM1937†	1966-70	RH rear	114.99 ea

E-Body	Year	Side	Price
MM1414	1970-74	LH front	114.99 ea
MM1415	1970-74	RH front	114.99 ea

Standard Replacement

B-Body	Year	Side	Price
MM1410A	1966-70	LH front	89.99 ea
MM1411A	1966-70	RH front	89.99 ea
MM1412A*	1966-70	LH rear	89.99 ea
MM1413A*	1966-70	RH rear	89.99 ea



MM8310

1966-74 Front Leaf Spring Brackets

Replacement front leaf spring shackle perch and inner reinforcement brackets for 1966-74 B and E-Body models. The front mounts are welded to the rear frame rail and inner rocker panel.

B-Body	Year	Side	Price
MM8310	1966-70	LH perch bracket	49.99 ea
MM8311	1966-70	RH perch bracket	49.99 ea
MM8312	1966-70	LH inner reinf.	24.99 ea
MM8313	1966-70	RH inner reinf.	24.99 ea
MM8314	1970-74	LH outer reinf.	39.99 ea
MM8315	1970-74	RH outer reinf.	39.99 ea

E-Body	Year	Side	Price
MM8305	1970-74	LH perch bracket	23.99 ea
MM8306	1970-74	RH perch bracket	23.99 ea
MM8307	1970-74	LH perch reinf.	23.99 ea
MM8308	1970-74	RH perch reinf.	23.99 ea



MDS056

MDS057

1970-74 E-Body Spring Hanger Gussets

Steel reproduction of the front leaf spring hanger gussets for 1970-74 E-Body models. This metal reinforcement is welded in place between the rear frame rail and the rocker panel, just in front of the wheelhouse. Each gusset comes EDP coated and is designed to replace the original exactly.

ME5056	1970-74	LH	25.99 ea
ME5057	1970-74	RH	25.99 ea



MMS176



1960-76 A-Body Rear Spring Mounts

This rear spring mount for A-Body models is a replacement for a commonly rusted area. The rear wheel kicks up debris into this area where it is trapped and causes the mount to deteriorate, moving the leaf spring inside the trunk. Remove the existing spring box and any rust on the frame, and install this mount over the existing frame rail. This spring mount runs approximately 20" forward of the rear crossmember.

MM8176	1960-76	LH	184.99 ea
MM8177	1960-76	RH	184.99 ea
MM8178	1960-76	LH & RH	314.99 pr



MMS117



1962-76 Total Performance Paks

These Performance Paks are a popular addition to any High-Performance vehicle. They come with 4 torque boxes and 2 frame connectors. The torque boxes add 20%+ rigidity to the frame, while the frame connectors link the front and rear subframes together for added chassis rigidity. Made in USA.

A-Body	Year	Price
MM8173	1966-76	399.99 set
B-Body	Year	Price
MM8030	1962-65	399.99 set
MM8031	1966-70	399.99 set
E-Body	Year	Price
MM8116	1970-74	Barracuda 399.99 set
MM8117	1970-74	Challenger 399.99 set



MM1617

MM1616

1971-72 B-Body Vapor Canister Shields

Replacement vapor canister shields for 1971-72 B-Body models. The front canister shield fits in front of the left hand rear wheelhouse panel and rear shield fits behind the wheelhouse to protect the canister hose.

MM1616	1971-72	front	44.99 ea
MM1617	1971-72	rear	44.99 ea



MMS166

MMS169

1960-76 Torque Boxes

At the factory, torque boxes were known as "Hemi boxes" or "double floor plates". These resist torsional flex, and when combined with subframe connectors, add 20%+ rigidity to the framework. These are not factory-stamped pieces for show car points, these are heavy-duty, performance-oriented structural enhancements. Made in the USA.

A-Body	Year	Side	Price
MM8166	1960-76	LH rear	74.99 ea
MM8167	1960-76	RH rear	74.99 ea
MM8168	1960-76	rear pair	125.99 pr
MM8169	1960-76	LH front	74.99 ea
MM8170	1960-76	RH front	74.99 ea
MM8171	1960-76	front pair	125.99 pr
MM8172	1960-76	front & rear set	251.99 set

B-Body	Year	Side	Price
MM8009	1962-65	LH rear	69.99 ea
MM8010	1962-65	RH rear	69.99 ea
MM8011	1962-65	rear pair	125.99 pr
MM8012	1962-65	LH front	69.99 ea
MM8013	1962-65	RH front	69.99 ea
MM8014	1962-65	front pair	125.99 pr
MM8015	1962-65	front & rear set	251.99 set
MM8016	1966-70	LH rear	74.99 ea
MM8017	1966-70	RH rear	74.99 ea
MM8018	1966-70	rear pair	125.99 pr
MM8019	1966-70	LH front	74.99 ea
MM8020	1966-70	RH front	74.99 ea
MM8021	1966-70	front pair	125.99 pr
MM8022	1966-70	front & rear set	251.99 set
MM8023	1971-72	LH rear	69.99 ea
MM8024	1971-72	RH rear	69.99 ea
MM8025	1971-72	rear pair	125.99 pr
MM8026	1971-72	LH front	69.99 ea
MM8027	1971-72	RH front	69.99 ea
MM8028	1971-72	front pair	125.99 pr
MM8029	1971-72	front & rear set	251.99 set

E-Body	Year	Side	Price
MM8109	1970-74	LH rear	74.99 ea
MM8110	1970-74	RH rear	74.99 ea
MM8111	1970-74	rear pair	164.99 pr
MM8112	1970-74	LH front	74.99 ea
MM8113	1970-74	RH front	74.99 ea
MM8114	1970-74	front pair	164.99 pr
MM8115	1970-74	front & rear set	319.99 set

Suspension Mount Repair



MM1280B

1966-76 Crossmember Shock Mount

Factory style replacement rear upper crossmember for various 1966-76 models. This piece is commonly rusted and can have deformed mounting holes, as well as twisted mounting points. Avoid these problems with this new upper shock crossmember. Your choice of our Restorer's Choice mount, officially licensed by Mopar, manufactured in OE-gauge steel featuring all original contours and details or our standard replacement for the car builder on a budget. Comes finished in black EDP coating to prevent rust.

Note: Shipped oversize.



Restorers Choice

MM8304	1967-76	A-Body	189.99 ea
MM1280B	1966-70	B-Body	224.99 ea
MM1281B	1970-74	E-Body	214.99 ea

Standard Replacement

MM1280A	1966-70	B-Body	179.99 ea
MM1281A	1970-74	E-Body	169.99 ea



MM8181



MM8034



MM8036



1966-76 Leaf Spring Mount Panels

Replacement front and rear leaf spring mount repair panels for 1966-76 A and B-Body models. Manufactured in heavy gauge steel, these mounts will exceed factory specifications. Removal of the existing unit is required before this product can be installed. Available individually or save money with a pair!

A-Body

Front Leaf Spring Mounts			
MM8181	1966-76	LH	159.99 ea
MM8182	1966-76	RH	159.99 ea
MM8183	1966-76	LH & RH	260.99 pr

B-Body

Front Leaf Spring Mounts			
MM8036	1966-70	LH	129.99 ea
MM8037	1966-70	RH	129.99 ea
MM8038	1966-70	LH & RH	215.99 pr

Rear Leaf Spring Mounts

MM8033	1966-70	LH	129.99 ea
MM8034	1966-70	RH	129.99 ea
MM8035	1966-70	LH & RH	215.99 pr



1971-74 Shock Crossmember Bracket

Steel reproduction of the rear shock cross member bracket for 1971-74 E-Body models. Each bracket comes EDP coated and is designed to replace the original exactly.

ME5058 1971-74 E-Body 11.99 ea



ME5055



ME5054

1970-74 E-Body Tie-Down Brackets

Reproduction tie-down brackets for 1970-74 E-Body models. This bracket bolts to the rear frame rails behind the rear axle, designed to provide an anchoring point for transporting the cars from the factory to the dealerships. Each bracket features correct bolt hole locations, comes EDP coated, and is designed to replace the original exactly.

ME5055 1970-74 LH 24.99 ea
ME5054 1970-74 RH 24.99 ea



MM1282



MM1283B



MM1283A

1967-76 Rear Cross Rails

Factory-style replacement rear cross rail for various 1967-76 models. Repair your structural integrity by installing this new rear cross rail to replace your rusted out or damaged original. Your choice of our Restorer's Choice rail, officially licensed by Mopar, manufactured in OE-gauge steel featuring all original contours and details or our standard replacement for the car builder on a budget. This component is installed by spot welding it to the trunk floor and is the rail that the rear bumper brackets are attached to. Comes finished in black EDP coating to prevent rust.

Note: Shipped oversize.



Restorers Choice

MM1282	1967-76	A-Body	194.99 ea
MM1283B	1968-70	B-Body	194.99 ea
MM1284B	1970-74	E-Body	194.99 ea

Standard Replacement

MM1283A	1968-70	B-Body	159.99 ea
MM1284A	1970-74	E-Body	159.99 ea



MM8140



MM8141



1970-74 E-Body Rear Frame Triangle Plate

This plate mounts on top of the rear frame rail where it joins the rear cross member, strengthening the frame. Available individually or save by ordering the pair! Made in USA.

MM8140 1970-74 LH 29.99 ea
MM8141 1970-74 RH 29.99 ea
MM8142 1970-74 LH & RH 67.99 pr



MM2568



MM1565A



MM1569A

1967-76 Rear Cross Rail Extensions

Factory-style replacement rear cross rail extension for 1967-76 models, excluding Charger. The cross rail extension is installed by welding it to the rear cross rail and quarter panel. Your choice of our Restorer's Choice extension, officially licensed by Mopar, manufactured in OE-gauge steel featuring all original contours and details or our standard replacement for the car builder on a budget. Comes finished in black EDP coating to prevent rust.

Restorers Choice

A-Body - all models
MM1564 1967-76 extension 39.99 pr

Coronet, Super Bee

MM1565B 1968-70 LH, extension 19.99 ea
MM1566B 1968-70 RH, extension 19.99 ea
MM1567B 1968-70 LH, reinforcement, 24.99 ea
MM1568B 1968-70 RH, reinforcement, 24.99 ea

Charger

MM2567 1971-72 LH, extension 19.99 ea
MM2568 1971-72 RH, extension 19.99 ea

Barracuda, Challenger

MM1569B 1970-74 LH, extension 19.99 ea
MM1570B 1970-74 RH, extension 19.99 ea

Standard Replacement

Coronet, Super Bee

MM1565A 1968-70 LH, extension 14.99 ea
MM1566A 1968-70 RH, extension 14.99 ea
MM1567A 1968-70 LH, reinforcement, 19.99 ea
MM1568A 1968-70 RH, reinforcement, 19.99 ea

Barracuda, Challenger

MM1569A 1970-74 LH, extension 14.99 ea
MM1570A 1970-74 RH, extension 14.99 ea

Windshield Wiper Parts

New!

OE



1968-69 A-Body "Anco Style" Wiper Arms

OE[®] reproduction "Anco style" wiper arms for 1968-69 A-body Dodge and Plymouth models. Manufactured from stamped and formed polished stainless steel and a chrome plated cap with correct spline design. Will work with both aftermarket and OE wiper blades. Sold as a pair.
2889951 1968-69 A-Body..... 149.99 pr

New!

OE



1970-74 E-Body "Anco Style" Wiper Arms

OE[®] reproduction "Anco style" wiper arms for 1970-74 Dodge and Plymouth E-body models. Manufactured from stamped and formed polished stainless steel and a chrome plated cap with correct design spline. Will work with both aftermarket and OE wiper blades. Sold as a pair.
ME7600 1970-74 E-Body..... 149.99 pr

New!

OE



A-Body
1968-71 all
1972-74 2 dr hardtop/4 dr sedan
B-Body
1968-71 all
E-Body
1970-74 all

1968-74 "Anco Style" Wiper Blades

OE[®] reproduction windshield wiper blade assemblies and inserts for various Dodge and Plymouth models. These 16" "Anco style" wiper blades are manufactured from stamped stainless steel with a quality molded rubber insert. Wiper blade assemblies are sold as a pair. Wiper blade refills are available and sold individually.
ME7601 1968-74 wiper blades..... 49.99 pr
ME7602 1968-74 refill..... 10.99 ea



A40350



A40362

1968-74 Rebuilt Windshield Wiper Motors

Rebuilt windshield wiper motors for various 1968-74 A, B and E-Body models. Each motor is rebuilt using the industry's most advanced remanufacturing technology. These wiper motors are the high quality, low cost alternative to brand name motors on the market. Why pay more? Enjoy safety, performance and reliability at a fraction of the cost of OE. Backed by a 1 year manufacturer's limited warranty.

2-Speed Wiper Motors

A40350 1968-71 A-body..... 109.99 ea
A40380 1972-74 A-body..... 64.99 ea

3-Speed Wiper Motors

A40362 1972-74 B-body..... 109.99 ea
A40362 1972-74 E-body..... 109.99 ea

Silicone Wiper Blades

Superior wiping in the harshest of weather conditions. Silicone blades will remain soft and flexible even after extended exposure to ozone, ultraviolet rays, ice, snow and heat. Silicone can handle grueling temperatures even as high as +350° F. Will not deteriorate, even after years of use. Change out your blades and when the rain begins to fall, you will have confidence that your silicone blades will be ready.

153224	15"	7.99 ea
153225	16"	7.99 ea
153226	18"	7.99 ea
153227	20"	7.99 ea
153228	22"	8.99 ea



Windshield Wiper Arm Remover

Make replacing or removing the windshield wiper arm easy with the correct windshield wiper arm removal tool. Allows you to remove the wiper arm safely without damage to the vehicle.

Y65750 6.99 ea



MAS2012



MAS2013



MB184606



MD600325



Made in USA

1963-76 Wiper Pivot Gaskets

Replacement wiper pivot gaskets for various 1963-76 models. Made in USA.

A-Body			
MAR2012	1963-66	10.99 set	
MAR2013	1967-76	10.99 set	
B-Body			
MB184606	1968-70	10.99 set	
MD600325	1971-74	4.99 set	
E-Body			
MD600325	1970-74	4.99 set	



1962-74 Wiper Motor Nut Set

Wiper motor mounting nut set for all 1962-74 Mopar models. Includes special steel nuts with attached washers to mount wiper motor to the firewall.
MMS8272 1962-74 3 pc set..... 5.99 set



Made in USA

1966-76 Wiper Motor To Cowl Gasket

This replacement 2-speed wiper motor to cowl gasket is designed to fit all 1966-76 models. Made in USA.
MD600326 1966-76..... 4.99 ea



88 BODY COMPONENTS

Windshield Washer Parts



1967-76 Washer Pump

Windshield washer pump for all 1967-74 models equipped with an electric washer pump. Features correct anodized motor housing, white plastic pump housing, attached ground wire and includes the gasket and filler.

Pump Assembly	
MP40101 1967-74	13.99 ea
Gasket & Filler Only	
MD2162 1967-76	9.99 set



1965-74 Washer Jar Cap

Replacement windshield washer jar cap. Made using black plastic. For all 1965-74 models.

MD2164 1965-74	8.99 ea
----------------	---------



1960-76 Firewall Grommet

Replace your damaged or missing firewall washer grommet with a quality replacement. For all models equipped with a foot pump washer pump.

MD2163 1960-76	5.99 ea
----------------	---------



1963-74 Mopar Washer Connectors

Windshield washer fittings built to original specifications and with the correct color plastic for an unmatched fit and appearance.

667322 1963-70 A-Body	7.99 ea
667321 1967-70 B-Body	9.99 ea
667323 1971-74 B-Body	9.99 ea
667323 1970-74 E-Body	9.99 ea



MD2151- clear finish



MD2152- clear finish



MB2287- aged finish

1965-74 Windshield Washer Jars

Replace your cracked or missing windshield washer jar with a quality reproduction. Each jar features correct mounting points, includes mounting hardware and is available in varying finishes such as clear, aged or yellow. Available for vehicles with electric or manual pumps.

Important: All bottles include the correct cap without lettering and all electric washer bottles include a pump gasket. Pump not included.

Note: *Includes electric pump.

A-Body

Models with Electric Pump	
MA2196 1967-74 clear finish	54.99 ea

Models with Manual Pump	
MD2151 1965-69 clear finish	54.99 ea
MA2197 1970-74 aged finish	51.99 ea

B-Body

Models with Electric Pump	
MB2287 1967 aged finish	59.99 ea
MB2289 1968-70 clear finish	49.99 ea
MB2290 1968-70 aged finish	59.99 ea
MD2154 1971 clear finish	54.99 ea
MD2155 1971 aged finish	59.99 ea
MD2158 1972 clear finish	54.99 ea
MB2291 1973-74 clear finish	104.99 ea

Models with Manual Pump	
MD2151 1965 clear finish	54.99 ea
MD2152 1966 clear finish	59.99 ea
MD2156 1971 aged finish	49.99 ea
MD2160 1972 aged finish	64.99 ea

E-Body

Models with Electric Pump	
ME1586 1970 clear finish	59.99 ea
MD2154 1971 clear finish	54.99 ea
MD2155 1971 aged finish	59.99 ea
MD2158 1972-74 clear finish	54.99 ea

Models with Manual Pump	
ME1584 1970 clear finish	54.99 ea
MD2156 1971 aged finish	49.99 ea
MD2160 1972-74 aged finish	64.99 ea



ME1590

1970 AAR & T/A Washer Nozzles

Correct windshield washer nozzles for 1970 AAR 'Cuda and Challenger T/A models. Originally for fiberglass hoods, these metal nozzles feature the correct lead tube, black head and include the retainer nut.

ME1588 1970 LH	59.99 ea
ME1589 1970 RH	59.99 ea
ME1590 1970 pair	114.99 pr

OFF AUTHORIZED



K6675

1966-74 Washer Nozzle Sets

Windshield washer nozzle sets for 1967-74 A-Bodies, 1966-72 B-Bodies, and 1970-74 E-Body models. Available for various models with electric or manual washer pumps. Include mounting hardware.

A-Body	
K6671 1967-74 electric or manual	35.99 kit

B-Body	
K6673 1966-67 electric or manual	44.99 kit
K6675 1967-70 electric only	35.99 kit
K6677 1971-72 electric or manual	35.99 kit

E-Body	
K6679 1970-74 electric or manual	35.99 kit



MB2292

1965-74 Windshield Washer Hose Sets

Windshield washer hose sets for various 1965-74 models. These rubber hoses route from the washer jar to the squirt nozzles. Available for models with electric or manual pumps.

A-Body	
MA2198 1967-74 with manual pump	19.99 set
MA2199 1967-74 with electric pump	16.99 set

B-Body	
MB2292 1965 with electric pump	16.99 set
MB2293 1966 with electric pump	17.99 set
MB2294 1967-70 with electric pump	16.99 set
MD2165 1971-72 with manual pump	29.99 set
MD2166 1971-72 with electric pump	24.99 set

E-Body	
MD2165 1970-74 with manual pump	29.99 set
MD2166 1970-74 with electric pump	24.99 set

Body Tools

Soft Duty - Delicate prying or wedging
Med. Duty - Sturdy prying or wedging
Heavy Duty - Very strong and durable

Prying and Scraping Tools

Available in 3 different fiberglass reinforced plastics, the soft duty tools are good for jobs where a minimum amount of force is needed to remove objects. The medium duty tools are better for the objects that require a little more force to remove, and the heavy duty tools are for the objects that are real stubborn and just do not want to be separated from their current position. All these tools are strong enough to pry yet soft enough to do interior and exterior automotive jobs without the damage that metal tools can do.

7 Piece Prying and Wedging Tools

T2300S	soft duty	24.99 set
T2300M	medium duty	24.99 set
T2300H	heavy duty	24.99 set
4 Piece Scraper Tools		
T2301M	medium duty	17.99 set
T2301H	heavy duty	17.99 set
Metric Gap Gauge		
T2302	1-15mm	4.99 ea

Multi Wedge Prying & Scraping Tools

Multi Wedge is an amazing automotive restoration tool that will replace screwdrivers, pry bars and all other metal tools that can cause damage and marring to delicate surfaces! The soft, orange wedge set and the jumbo wedge are made from a high tech, specially blended polyethylene that is incredibly ductile so they won't break or snap. The hard, black wedge set is made from a high tech, specially blended polycarbonate for the heavy duty jobs like oil pan covers, timing covers or valve covers. Each 3 piece set includes one 4" curved end, one 4" straight blade and one 3" straight blade. Buy both sets and save! The jumbo wedge is 14" in length and 2" wide, making it perfect for the big jobs. MW01 orange wedges, soft-set of 3 12.99 set
 MW02 black wedges, hard-set of 3 13.99 set
 MW03 both wedges, soft&hard (set of 6) 19.99 set
 MW04 jumbo wedge 12.99 ea

Pro Paint Gauge

The Pro Gauge is a device which measures paint thickness. Factory paint is usually four to five mils in thickness. By using the Pro Gauge you can determine if the car has been repainted. For instance, you can take measurements of about 4.5 mill around the car but the hood may read seven mils on the Pro Gauge. That tells you the hood has been repainted.

PG2437	84.99 ea
--------	----------

Eliminate Rust Remover

Before touching up paint, you first must remove all rust, wax and dirt or the rust will return and the paint won't adhere. This unique tool will scrub away all dirt, rust and wax. The results are touch up paint adheres, seals and blends smoothly into the rest of the paint.

E3437	9.99 ea
-------	---------

Body Removal Tools

Pulls dented sheet metal back into place with our convenient tools. 13" long shaft with 1/2" - 13 UNC thread screw on our slide hammer permits high pulling force.

X2290	slide hammer set	38.99 set
X2290-70	replacement hook & screw	3.99 ea
X2290-76	replacement nose nut	7.99 ea



Body Dent Removal Tools

The pull rod set includes 4 pull rods with formed shank, 2 pick pulls with straight shank, straight edge and HS split point drill bit.

S20000	pull rod set	44.99 set
--------	--------------	-----------



Cleco Sheet Metal Fastener Set

This Cleco sheet metal fastener set contains everything you need to secure sheet metal panels during the fit and alignment stage. The pliers can be used with all standard spring loaded fasteners and clamps. The complete kit contains one pair of Cleco pliers, twenty-five 1/8" Kwik-Lok clecos and four side grip fastener clamps. Also available are individual components so you can add to your kit as necessary.

Complete Kit

X9858	29 pieces	49.99 kit
Clecos		
X9859	Clecos 1/8"	1.49 ea
X9860	Clecos 3/16"	1.49 ea
Side Grip Fastener Clamps		
X9862	3/4" x 1"	4.99 ea
Cleco Pliers		
X9863	Cleco pliers	10.99 ea

Deluxe 6" Dent Puller

Suction disc is 6" in diameter with steel handle and steel support plates for strong pull. Works on nearly every dent where the sheet metal has not been creased.

X2761	29.99 ea
-------	----------



Plugweld Pliers

These plugweld pliers make plug welding fast and easy. Panels won't separate and copper alloy pad prevents burn through, allows higher welding temperature and better penetration.

S23230	pliers	36.99 ea
S23231	replacement pad	6.99 ea



Visegrip Flange Pliers

Preparing panels with an offset flange will produce a clean, flush fit. Work on up to 18 gauge sheet metal without removing panels from the car. The added feature of "Vise-Grip" locking pliers allows for better leverage. Available with your choice of 1/2" wide non-slip jaw or wider 1" clamping surface.

13229	1/2" wide jaw	29.99 ea
X9853	1" wide jaw	39.99 ea



Seam Buster HD Clinks

Easily separate spot welded or bonded panels. Save up to 15 minutes per panel replacement. Great for quarter panels, rocker panels and other pinch welded areas. Sharpened on two edges, the sharp end allows for penetration between panels and the side edge allows for side impact to drive the panels apart without damage. Made of super tough alloy steel. Cushioned handle absorbs shock.

S20015	straight	29.99 ea
S20016	90° angle	32.99 ea
S20017	air hammer	49.99 ea



Double-End Spotweld Cutter

Double-end spotweld cutters makes removing body panels fast and easy. Their hollow design cuts around the spotweld so weld hardness does not affect tool sharpness. When one end becomes dull, simply unscrew the cutter and flip it over using the new teeth on the other end. An adjustable depth rod sets the tool so only the outer panel is cut, leaving the underlying panel undamaged.

13224	arbor with cutter	16.99 ea
13214	replacement cutters, 3 piece	16.99 set
13216	replacement arbor	12.99 ea
13217	replacement pilot, 3 piece	5.99 set

Sheet Metal Tools



Blair Cutter

Blaircutters provide fast, accurate holes in materials up to 3/16" thick. Unlike hole saws, that rip and tear through the material, these cutters provide a quality, virtually burr-free hole. Available in seven sizes for 1/4" and larger drill chucks. Spring loaded pilot "pops" the slug from the cutter. Buy the set and save! Set includes all cutters, arbor and 3 extra pilots.

- Note: D.O.C. = depth of cut. Arbors and Cutters sold separately.*
- Blaircutter Set**
13218 11 pc set..... 61.99 set
Arbor For 1/4" & Larger Chucks
13216 w/pilot pin..... 12.99 ea
- Replacement Pilot**
13217 3 piece..... 5.99 set
- Cutters 3/16" D.O.C.**
13201 1/4"..... 12.99 ea
13202 5/16"..... 14.99 ea
13204 3/8"..... 16.99 ea
13206 7/16"..... 22.99 ea
13208 1/2"..... 24.99 ea
13210 9/16"..... 25.99 ea
13212 5/8"..... 29.99 ea



Premium Spotweld Cutters

When you have a lot of spotwelds to remove, step up to the premium spotweld cutters for longer life than today's high-strength body steels. These cutters have a heavier wall (.090") for extreme durability and two step geometry that splits the chips and helps clear them. Premium spotweld cutters have a fast cutting action and lasts for hundreds of spotwelds. They are for use in 3/8" or larger drill chucks. The spotweld cutters are available individually or in sets containing arbor, 3 cutters, your choice of 2 skip-proof or 2 standard pilots.

- Spotweld Cutter Set**
11096 w/skip-proof pilot... 49.99 set
11082 w/standard pilot.... 46.99 set
- Arbor with Cutter**
11093 skip-proof..... 29.99 ea
11094 standard..... 29.99 ea
- 11093 Replacement Parts**
11123 arbor..... 24.99 ea
11097 pilot - 3 piece..... 15.99 set
111083 cutters - 3 piece..... 29.99 set
- 11094 Replacement Parts**
11122 arbor..... 18.99 ea
11121 pilot - 3 piece..... 6.99 set
111083 cutters - 3 piece..... 29.99 set



Blair Stick Lubricant

Convenient 1.68 oz. tube is ideal for all Blair hole cutters. Softer than standard stick lubricants, it provides superior adhesion to the tool and can be used in place of cutting fluids on ferrous and nonferrous metals to increase tool life, improve cutting performance and easier slug removal.

- 11750 1.68 oz..... 5.99 ea



Blair Hole Cutter

Holecutters are not hole saws. They can produce holes 3 times faster and cleaner than hole saws in sheet metal up to 1/8" thick and have a dramatically extended tool life. Holecutters produce holes from 1/16" up to 3" diameter in sheet metal, rubber, gasket or fiber materials and some plastics. Ideal for aftermarket installations, custom fabrication, trailers, or gauge installation. Arbor fits 3/8" drilled chucks. Holecutters have a new, patented Quad-Lead Thread System for quick cutter changes. Buy the set and save! Holecutter set includes: arbor, hex washer, extra pilot & the following sizes of cutters, 7/8", 1-1/8", 1-1/4", 1-3/8", 1-3/4", 2" & 2-1/2".

- Note: D.O.C. = depth of cut. Arbors and cutters sold separately.*
- Holecutter Set**
40061..... 186.99 set
Arbor For 3/8" & Larger Chucks
146091..... 30.99 ea

- Replacement Pilot**
146101 3 piece..... 23.99 set
- Cutters 1/8" D.O.C.**
146221 1/16"..... 13.99 ea
146241 3/4"..... 13.99 ea
146261 13/16"..... 13.99 ea
146281 7/8"..... 13.99 ea
146301 15/16"..... 14.99 ea
146321 1"..... 14.99 ea
146341 1-1/16"..... 14.99 ea
146361 1-1/8"..... 14.99 ea
146381 1-3/16"..... 14.99 ea
146401 1-1/4"..... 15.99 ea
146421 1-5/16"..... 15.99 ea
146441 1-3/8"..... 15.99 ea
146461 1-7/16"..... 17.99 ea
146481 1-1/2"..... 17.99 ea
146501 1-9/16"..... 17.99 ea
146521 1-5/8"..... 17.99 ea
146541 1-11/16"..... 17.99 ea
146561 1-3/4"..... 19.99 ea
146601 1-7/8"..... 22.99 ea
146621 2"..... 24.99 ea
146641 2-1/16"..... 29.99 ea
146661 2-1/8"..... 29.99 ea
146681 2-1/4"..... 31.99 ea
146721 2-3/8"..... 32.99 ea
146741 2-1/2"..... 34.99 ea
146761 2-9/16"..... 41.99 ea
146781 2-5/8"..... 41.99 ea
146801 2-3/4"..... 42.99 ea
146821 2-7/8"..... 45.99 ea
146841 3"..... 45.99 ea



Blair Cutter Sets

- Antenna & Access Holecutter Set**
Note: Each set includes: arbor, extra pilot drills & cutters as shown.
14003 3/8", 1" & 1-1/4"..... 52.99 set
- Rustproof Cutter Set**
Note: Each set includes: arbor, (3) 1/2" cutters, pilot & extra pilot.
11081 with standard pilot - 11122..... 51.99 set
11095 with skip-proof pilot - 11123..... 54.99 set
- Painless Dent Removal Access Hole Set**
Note: Each set includes: arbor with standard pilot, extra pilot & cutters as shown.
11083 1/4", 3/8", 1/2", & 3/4"..... 61.99 set

Rotabroach Cutter Sets

Rotabroach annular cutters are ideal for sheet metal fabrication, Painless Dent Removal and for cutting rustproofing access holes without clogging. Unlike hole saws and twist drills that push and tear through materials, these cutters will make hundreds of holes in steel, sheet metal or plastics up to 1/2" thick with no deforming of stock, jagged edges or out-of-round holes. Arbors for Rotabroach cutters fit 3/8" and 1/2" hand held drill chucks and use either spring loaded pilots or skip-proof pilots which eliminate pre-drilling operations. Each set includes: arbor, hex wrench, center punch, extra pilot and a variety of cutters as listed.

- Note: D.O.C. = depth of cut. Arbors and cutters sold separately.*
- Rotabroach Cutter Set**
11090 5/16", 3/8", 7/16", 1/2", 9/16", 5/8", & 3/4"..... 84.99 set
11092 8mm, 10mm, 12mm, 14mm, 16mm, 18mm & 20mm..... 84.99 set
11091 7/8", 1", 1-1/8", 1-1/4", 1-3/8", & 1-1/2"..... 224.99 set
- Arbor For 3/8" & Larger Drill Chucks**
11122 1/4" - 3/4" or 6mm - 20mm cutters w/pilot pin..... 19.99 ea
11123 3/8" - 3/4" or 10mm - 20mm cutters w/skip proof pilot... 24.99 ea
- Arbor For 1/2" & Larger Drill Chucks**
11007 13/16" - 1-1/2" cutters..... 39.99 ea
- 3 Pack Replacement Pilot**
11121 pilot for 11122 arbor..... 6.99 set
11097 pilot for 11123 arbor..... 15.99 set
11628 pilot for 11007 arbor..... 19.99 set

Rotabroach Replacement Cutters

- Replacement cutters for Rotabroach cutter set. Available in a 3 pack or as individual cutters in a variety of sizes.
- 3 Pack Cutters 1/4" Depth of Cut For Use with 11122 Arbor Only**
111003 1/4"..... 23.99 set | 112073 7mm..... 23.99 set
111043 5/16"..... 24.99 set | 112083 8mm..... 24.99 set
112063 6mm..... 23.99 set | 112093 9mm..... 28.99 set
- 3 Pack Cutters 1/4" Depth of Cut For Use with 11122 Or 11123 Arbor**
111083 3/8"..... 28.99 set | 112123 12mm..... 34.99 set
111123 7/16"..... 34.99 set | 112133 13mm..... 35.99 set
111063 1/2"..... 35.99 set | 112143 14mm..... 39.99 set
111203 9/16"..... 39.99 set | 112153 15mm..... 40.99 set
111243 5/8"..... 40.99 set | 112163 16mm..... 40.99 set
111283 11/16"..... 46.99 set | 112173 17mm..... 45.99 set
111323 3/4"..... 47.99 set | 112183 18mm..... 46.99 set
112103 10mm..... 32.99 set | 112193 19mm..... 47.99 set
112113 11mm..... 34.99 set | 112203 20mm..... 50.99 set

- Individual Cutters 1/2" Depth of Cut For Use with 11007 Arbor**
11336 13/16"..... 25.99 ea | 11360 1-3/16"..... 37.99 ea
11340 7/8"..... 27.99 ea | 11364 1-1/4"..... 40.99 ea
11344 15/16"..... 28.99 ea | 11365 1-5/16"..... 42.99 ea
11348 1"..... 29.99 ea | 11366 1-3/8"..... 44.99 ea
11352 1-1/16"..... 33.99 ea | 11367 1-7/16"..... 45.99 ea
11356 1-1/8"..... 34.99 ea | 11368 1-1/2"..... 46.99 ea

Power Steering Pumps



PS6157



PS130 front



PS130 rear



PS6159



PS6021



PS6122

1965-76 Power Steering Pumps

Remanufactured Units

Remanufactured power steering pumps for 1965-76 Mopar A-Body, B-Body and E-Body models. Thoroughly reconditioned, these pumps are carefully inspected, rebuilt and restored to OEM appearance and function! Resources are original configuration for complete authenticity! Careful attention is paid to reservoir reconditioning to ensure an OE appearance. This is a good choice for restorations when an original locking reservoir is desired. No core charge. **NO CORE CHARGE REQUIRED!**

A-Body - 6 Cylinder

Federal Pump w/Reservoir	
PS6157 1969-72 all	239.99 ea
PS6157 1973-74 with AC	239.99 ea
PS6157 1975-76 all	239.99 ea
Saginaw Pump w/Reservoir	
PS6159 1972 all	79.99 ea
PS6159 1973-74 w/o AC	79.99 ea
PS6021 1975-76 all	109.99 ea
Saginaw Pump w/ Reservoir	
96140 1972-74 all	104.99 ea
PS840 1975-76 all	39.99 ea

A-Body - 8 Cylinder

Federal Pump w/Reservoir	
PS6157 1969-74 all	239.99 ea
Federal Pump w/o Reservoir	
PS130 1969-74 all	69.99 ea
Saginaw Pump w/Reservoir	
PS6122 1969-71 383	159.99 ea
PS6159 1969-74 all	79.99 ea
PS6021 1975-76 all	109.99 ea
PS6801 1975-76 w/smog	54.99 ea
Saginaw Pump w/ Reservoir	
96140 1969-74 all	104.99 ea
PS840 1975-76 all	39.99 ea

B-Body - 6 Cylinder

Federal Pump w/Reservoir	
PS6157 1969-76 all	239.99 ea
Federal Pump w/o Reservoir	
PS130 1975 all	69.99 ea
Saginaw Pump w/Reservoir	
PS6159 1973-74 all	79.99 ea
PS6021 1975-76 all	109.99 ea
Saginaw Pump w/ Reservoir	
96140 1973-74 all	104.99 ea

B-Body - 8 Cylinder

Federal Pump w/Reservoir	
PS6157 1969 318	239.99 ea
PS6157 1970-71 318, 340	239.99 ea
PS6157 1972 318, 340	239.99 ea
PS6157 1972 400, 440	239.99 ea
PS6157 1973-74 all	239.99 ea
PS6144 1975-76 all	99.99 ea
Federal Pump w/o Reservoir	
PS130 1969-75 all	69.99 ea
Saginaw Pump w/Reservoir	
PS6122 1969 all except 318	159.99 ea
PS6122 1970-71 383, 426, 440	159.99 ea
PS6122 1972 340, 400, 440	159.99 ea
PS6159 1969 318	79.99 ea
PS6159 1970-71 318, 340	79.99 ea
PS6159 1972 318	79.99 ea
PS6159 1973-74 all	79.99 ea
PS6021 1975-76 318, 340 w/ smog	109.99 ea
PS6021 1975-76 400, 440	109.99 ea
E-Saginaw Pump w/ Reservoir	
96140 1965-74 all	104.99 ea
PS840 1975 all	39.99 ea

E-Body - 6 Cylinder

Federal Pump w/Reservoir	
PS6157 1970-74 all	239.99 ea
Saginaw Pump w/Reservoir	
PS6159 1973-74 all	79.99 ea
Federal Pump w/o Reservoir	
PS130 1970-74 all	69.99 ea

E-Body - 8 Cylinder

Federal Pump w/Reservoir	
PS6157 1970-72 318, 340	239.99 ea
PS6157 1973-74 all	239.99 ea
Saginaw Pump w/Reservoir	
PS130 1970-72 318, 340	69.99 ea
Saginaw Pump w/Reservoir	
PS6122 1970-72 383, 426, 440	159.99 ea
PS6159 1970-72 318, 340	79.99 ea
PS6159 1973-74 all	79.99 ea
Saginaw Pump w/o Reservoir	
96140 1970-74 all	104.99 ea

1969-74 OE Style **OEM AUTHORIZED** Power Steering Pump **New!**

Brand New Units

Brand-New OER Authorized® power steering pumps have been manufactured to meet the highest OEM standards of quality while maintaining an authentic original style appearance. This brand new power steering pump features a reservoir in the correct original configuration, with the proper return fitting and clogging. This not only ensures authenticity, but makes installation quick and easy. Also included with each pump is the shaft nut and replacement style power steering cap. **NO CORE CHARGE REQUIRED!**

Note: Pressure fittings and pulley are not included.

A-Body - Saginaw Pump

NP6159 1969-74 8 cylinder	189.99 ea
NP6159 1972 6 cylinder	189.99 ea
NP6159 1969-74 6 cyl. w/o A/C	189.99 ea

B-Body - Saginaw Pump

NP6159 1969 8 cylinder, 318	189.99 ea
NP6159 1970-71 8 cylinder, 318, 340	189.99 ea
NP6159 1972 8 cylinder, 318	189.99 ea
NP6159 1973-74 6 cylinder	189.99 ea
NP6159 1973-74 8 cylinder	189.99 ea

E-Body - Saginaw Pump

NP6159 1970-72 8 cylinder, 318, 340	189.99 ea
NP6159 1973-74 6 cylinder	189.99 ea
NP6159 1973-74 8 cylinder	189.99 ea

1965-76 Saginaw PS Pump Cap

Replace your damaged or missing power steering reservoir cap with a quality aftermarket cap. These caps fit perfectly on Saginaw power steering pump reservoirs. 7834183 1965-76 PS pump cap..... 4.99 ea

Saginaw PS Pump Cap Cover

Cover your power steering reservoir pump cap with this new snap-over cover. Fits most OEM applications with Saginaw power steering pump, 2" diameter. T9257 chrome cover..... 4.99 ea

Power Steering Fluid

Get the race-winning experience of Joe Gibbs under your hood with Joe Gibbs power steering fluid. This power steering fluid is specially formulated to avoid foaming at high temperatures for superior cooling properties. JGI306 quart..... 19.99 ea
JGI307 case of 12 quarts..... 239.99 ea

Royal Purple® MAX EZ Power Steering Fluid

Max EZ is formulated with a blend of select synthetic base oils plus Royal Purple's proprietary Syntec additive technology, which is proven to make equipment run cooler, smoother, longer, quieter and more efficiently. Max EZ is compatible and can be mixed with conventional power steering fluids and has excellent seal compatibility. RP01326 12 oz. bottle..... 5.99 ea
RP12326 case of 12 - 12 oz. bottles..... 69.99 ea

STEERING, SUSPENSION, REAR END & BRAKES

Power Steering Parts



MD2604



MD2196

1964-69 TRW Power Steering Brackets

TRW power steering brackets for 1964-69 small blocks, big block and Hemi engines. These are for non-AC applications. To correctly use these brackets, the big block and Hemi TRW pump must have a reservoir body to rear pulley face distance of 1-3/4". Includes 3 OE correct 5/16"-18 hex conic stems bolts for pump to bracket attachment and the bolt to mount the assembly to the water pump housing. Extra washer provided for adjusting slot bolt. Brackets are powder coated in low gloss black for better appearance and longer life.

MD2604	1964-69	small block	54.99	set
MD2196	1966	Hemi	64.99	set
MD2196	1966-69	big block w/o AC	64.99	set



MD2187



MD2186

1967-72 Federal Power Steering Brackets

Federal power steering pump mounting brackets for 1967-72 small block, big block and Hemi engines with aluminum water pump. These are for both AC and non-AC applications. Includes 3 OE correct 5/16"-18 place bolts for pump to bracket attachment and the bolt to mount the assembly to the water pump housing. Extra washer provided for adjusting slot bolt. Brackets are powder coated in low gloss black for better appearance and longer life.

MD2187	1967-72	big block	74.99	set
MD2187	1967-71	Hemi	74.99	set
MD2186	1970-72	small block	74.99	set



MD2602



MD2603



MD47208

1969-76 Saginaw Power Steering Brackets

Saginaw power steering mounting brackets for 1969-76 small block and big block engines with or without AC. These factory-style replacement power steering pump brackets include correct OE-style fasteners to mount the pump to the brackets and to mount the assembly to the water pump housing. An extra washer is also provided for the water pump housing bolt in the adjusting slot. These brackets come powder coated black for long life and a great appearance.

*Note: *For models with aluminum water pump.*

MD2602	1969-76	big block w/o AC	54.99	set
MD2603	1970-76	LA small block	74.99	set
MD47208*	1970-74	LA small block	109.99	set

Note: This set is not compatible with 1980 and later metric power steering pumps.



Saginaw PS Pump Mounting Bolt Sets

These sets include all bolts, washers, nuts, and studs required to mount the Saginaw power steering pump to your small or big block engine, including the unique studs that have been out of production for years.

Note: This set is not compatible with 1980 and later metric power steering pumps.

MD47206	1965-76	chrome	49.99	set
---------	---------	--------	-------	-------	-----



MD2382

MD2383

Saginaw Power Steering Pulleys

Reproduction power steering pulleys for Saginaw power steering pumps on B/RB/Hemi applications. Choose black satin finish like the originals or chrome.

Important: Can be used on 1970 and up small block engines but require spacer set MD47207 for correct alignment.

MD2381	keyed	black	99.99	ea
MD2382	keyed	chrome	109.99	ea
MD2383	press fit	black	99.99	ea
MD2384	press fit	chrome	109.99	ea



Saginaw Pulley Conversion Bolt Set

If your small block has a Saginaw pump but no power steering pulley, this bolt and spacer set is the solution! This set mounts big block power steering pulleys: MD2381, MD2382, MD2383, and MD2384 on your small block power steering pump.

MD47207	1970-74	small block	12.99	set
---------	---------	-------------	-------	-------	-----

New!

DEP AUTHORIZED



1965-76 Saginaw PS Pump Rebuild Set

Saginaw power steering pump rebuild set. This set includes parts you'll need to recover your old power steering pump. Refer to your factory service manual for instructions.

Note: Sets are for vehicles with Saginaw Power steering pumps only.

A-BODY

1253550	1969-76	Dart	14.99	set
1253550	1967-69	Barracuda	14.99	set
1253550	1969-76	Valiant	14.99	set
1253550	1971-76	Scamp	14.99	set

B-BODY

1253550	1965-76	Coronet	14.99	set
1253550	1966-76	Charger	14.99	set
1253550	1965-70	Belvedere	14.99	set
1253550	1965-74	Satellite	14.99	set
1253550	1971-74	Road Runner	14.99	set

E-BODY

1253550	1970-74	Challenger	14.99	set
1253550	1970-74	Barracuda/Cuda	14.99	set

Power Steering Parts



1961-76 Power Steering Pressure Hoses

Power steering pressure hoses for 1961-76 A-Body, B-Body and E-Body models. Replace your cracked power steering hoses before larger problems occur. The pressure hose connects from the power steering pump to the control valve/gear inlet.

1961-76 Federal Power Steering Pressure Hoses

A-Body		
6 Cylinder Engines		
70329	1961-67	all models..... 39.99 ea
8 Cylinder Engines		
70329	1964	Dart/Valiant..... 39.99 ea
70329	1964-66	Barracuda..... 39.99 ea
80119M	1969	Dart, 383..... 22.99 ea
80119M	1970-72	except Valiant..... 22.99 ea
70341	1970-72	Valiant..... 19.99 ea
70353	1973-74	except Dart..... 22.99 ea
80127M	1973-74	Dart..... 22.99 ea
71156	1975-76	Scamp/Duster, 318 w/air pump & 360..... 19.99 ea

B-Body		
8 Cylinder Engines		
70329	1960-66	all models..... 39.99 ea
70333	1967-68	all models, except 440 & Hemi..... 29.99 ea
70337	1969-72	all models, hose length 36-3/8"..... 19.99 ea
80119M	1970-71	Super Bee/Charger, hose length 28"..... 22.99 ea
80119M	1970-72	Coronet/Satellite/Road Runner, hose length 28"..... 22.99 ea
80127M	1972-74	Dodge models, hose length 38-1/4"..... 22.99 ea
80127M	1973-74	Plymouth models, hose length 38-1/4"..... 22.99 ea
80126M	1973-76	Dodge models, hose length 32"..... 24.99 ea

E-Body		
70337	1970-71	all models, big block..... 19.99 ea
80119M	1970-72	all models, small block..... 22.99 ea
80127M	1973-74	all models, small block..... 22.99 ea

1969-76 Saginaw Power Steering Pressure Hoses

A-Body		
8 Cylinder Engines		
70343	1969	except Dart w/383..... 22.99 ea
70344	1970-72	Dart..... 22.99 ea
70347	1974-76	Valiant 318 with air pump and 360 4 bbl..... 22.99 ea
70347	1974-76	Duster 318 w/o air pump and 360..... 22.99 ea
70347	1974-76	Scamp 318 w/o air pump..... 22.99 ea
70347	1974-76	Dart 318 with air pump and 360 4 bbl..... 22.99 ea
70351	1974-76	all models 318 w/o air pump and 360 2 bbl..... 22.99 ea

B-Body		
8 Cylinder Engines		
70343	1969-72	all models 318, 383, 400, 440..... 22.99 ea
70351	1973-76	all models all w/air pump..... 22.99 ea
70347	1974-76	Charger..... 22.99 ea

E-Body		
8 Cylinder Engines		
70343	1970-71	all models 383, 440..... 22.99 ea
70344	1970-72	all models 318, 340..... 22.99 ea
70351	1973-74	all models 318, 340..... 22.99 ea



1968-74 Power Steering Return Hose Clamps

Correct power steering return hose clamps for 1968-74 A, B and E-Body models. These clamps have the correct red color as the original for those added judging points. Sold in pairs.

MD2182	1968-74	red..... 4.99 pr
--------	---------	------------------



Date Coded Power Steering Return Hose Set

Reproduction date coded power steering return hose for your restored Mopar. Includes the correct style 18" hose and 4 correct clamps. Licensed by Mopar as an Authentic Mopar Restoration Product. Replace that old cracked return hose with an authentic reproduction part.

MD2171	May 1968.....	24.99 ea
MD2172	October 1968.....	24.99 ea
MD2173	January 1969.....	24.99 ea
MD2174	May 1969.....	24.99 ea
MD2175	October 1969.....	24.99 ea
MD2176	June 1970.....	24.99 ea
MD2177	January 1971.....	24.99 ea
MD2178	April 1971.....	24.99 ea
MD2179	June 1971.....	24.99 ea
MD2180	January 1972.....	24.99 ea
MD2181	No Date Code.....	16.99 ea



1960-76 Power Steering Return Hose

These are replacement hoses for the power steering return line for 1960-76 A-Body, B-Body and E-Body models. Cut to fit.

5/8" I.D. Hose		
MD2183	1960-66	42"..... 24.99 ea
3/8" I.D. Hose		
71224	1967-76	24"..... 16.99 ea



1962-72 Power Steering Gear Boxes

Replace your worn power steering box! These remanufactured power steering boxes are given a cool dip finish for rust protection before receiving new O-rings and lip seals and being hydraulically tested to guarantee leak free performance. These gear boxes install and function as original but may differ in appearance. Pitman arm is included.

Important: No core exchange required.
Note: The steering system must be flushed and replaced with OE recommended fluid. Hoses should be inspected and replaced if they have been in use for more than 5 years.

A-Body		
MN7501	1963-66.....	199.99 ea
MN7503	1967-72.....	199.99 ea

B-Body		
MN7501	1962-64	Plymouth Fury, Savoy..... 199.99 ea
MN7502	1962-64	Dodge Polara..... 199.99 ea
MN7502	1962-70	Plymouth Belvedere..... 199.99 ea
MN7502	1965-70	Dodge Coronet, Plymouth Satellite..... 199.99 ea
MN7502	1966-70	Dodge Charger..... 199.99 ea
MN7502	1967-70	Plymouth GTX..... 199.99 ea
MN7502	1968-70	Plymouth Roadrunner..... 199.99 ea
MN7500	1971-72	all..... 154.99 ea

E-Body		
MN7500	1970-72	all..... 154.99 ea

Power Steering Parts

New!

AUTHENTIC
REPRODUCTION



Authentic Style Power Steering Belts

Are your belts showing signs of deterioration including cracking and dry rot? If so, it's time to replace these potentially troublesome parts with our original style reproduction belts. Officially licensed by Mopar, they feature indented printing of the correct Mopar part numbers, manufacturer's code, appropriate date code, Chrysler Pentastar logo and they are cloth wrapped. These authentic looking reproductions are the finishing touch to any serious restoration and a great way to gain points over your car show competitors. You don't want something as simple as a worn or incorrect belt to keep you from winning your next trophy, and you certainly don't want to be left stranded on the way to your next show. Officially licensed by Mopar!

B4610	1969	Barracuda, 318, 340.....	33.99 ea
B4612	1969	Barracuda, 273, 318, 340 w/o AC.....	33.99 ea
B4614	1969	Barracuda, 383, 440.....	33.99 ea
B4616	1969	Barracuda, 383, 440.....	33.99 ea
B4710	1970	Barracuda, 318, 340, 360 w/o AC.....	33.99 ea
B4711	1970	Barracuda, 318, 340, 360 w/o AC.....	33.99 ea
B4712	1970	Barracuda, 383, 440 (44").....	33.99 ea
B4713	1970	Barracuda, 383, 440 (42 1/2").....	33.99 ea
B4714	1970	Barracuda, 426.....	33.99 ea
B4710E	1971	Barracuda, 318, 340, 360 w/o AC.....	33.99 ea
B4711E	1971	Barracuda, 318, 340, 360 w/o AC.....	33.99 ea
B4713E	1971	Barracuda, 383, 440.....	36.99 ea
B4714E	1971	Barracuda, 426.....	36.99 ea
B4750	1972	Barracuda, 318, 340, 360 w/o AC.....	36.99 ea
B4741	1972	Barracuda, 318, 340, 360 w/o AC.....	33.99 ea
B4610	1969	Belv, Chrg, Cmt, Rd Rr 318, 340 (42").....	33.99 ea
B4612	1969	Belv, Chrg, 273, 318, 340, w/AC.....	33.99 ea
B4612	1969	Cmt, Rd Rr 273, 318, 340 w/AC.....	33.99 ea
B4613	1969	Belv, Chrg, Cmt, Rd Rr 383, 440 (44").....	36.99 ea
B4614	1969	Belv, Chrg, Cmt, Rd Rr 383, 440 (43").....	36.99 ea
B4615	1969	Belv, Chrg, Cmt, Rd Rr 383, 440 (40 3/4").....	33.99 ea
B4617	1969	Belv, Chrg, Cmt, Rd Rr 426.....	33.99 ea
B4710	1970	Belv, Chrg, Cmt, Rd Rr 318, 340, 360 w/o AC.....	33.99 ea
B4711	1970	Belv, Chrg, Cmt, Rd Rr 318, 340, 360 w/o AC.....	33.99 ea
B4712	1970	Belv, Chrg, Cmt, Rd Rr 383, 440 (44").....	33.99 ea
B4713	1970	Belv, Chrg, Cmt, Rd Rr 383, 440 (42 1/2").....	33.99 ea
B4714	1970	Belv, Chrg, Cmt, Rd Rr 426.....	33.99 ea
B4710E	1971	Belv, Chrg, Cmt, Rd Rr 318, 340, 360 w/o AC.....	33.99 ea
B4711E	1971	Belv, Chrg, Cmt, Rd Rr 318, 340, 360 w/o AC.....	33.99 ea
B4713E	1971	Belv, Chrg, Cmt, Rd Rr 383, 440 (42 1/2").....	36.99 ea
B4714E	1971	Belv, Chrg, Cmt, Rd Rr 426.....	36.99 ea
B4750	1972	Belv, Chrg, Cmt, Rd Rr 318, 340, 360 w/o AC.....	36.99 ea
B4741	1972	Belv, Chrg, Cmt, Rd Rr 318, 340, 360 w/o AC.....	33.99 ea
B4751	1972	Belv, Chrg, Cmt, Rd Rr 400, 440.....	36.99 ea
B4752	1972	Belv, Chrg, Cmt, Rd Rr 400, 440 w/AC w/Air.....	36.99 ea
B4710	1970	Challenger, 318, 340, 360 w/o AC.....	33.99 ea
B4711	1970	Challenger, 318, 340, 360 w/o AC.....	33.99 ea
B4712	1970	Challenger, 383, 440 (44").....	33.99 ea
B4713	1970	Challenger, 383, 440 (42 1/2").....	33.99 ea
B4714	1970	Challenger, 426.....	33.99 ea
B4710E	1971	Challenger, 318, 340, 360 w/o AC.....	33.99 ea
B4711E	1971	Challenger, 318, 340, 360 w/o AC.....	33.99 ea
B4713E	1971	Challenger, 383, 440.....	36.99 ea
B4714E	1971	Challenger, 426.....	36.99 ea
B4750	1972	Challenger, 318, 340, 360 w/o AC.....	36.99 ea
B4741	1972	Challenger, 318, 340, 360 w/o AC.....	33.99 ea
B4714	1969	Chrysler Pass. Car, 383, 440 (43").....	33.99 ea
B4616	1969	Chrysler Pass. Car, 383, 440 (42 1/2).....	33.99 ea
B4710	1970	Chrysler Pass. Car, 318, 340, 360 w/o AC.....	33.99 ea
B4711	1970	Chrysler Pass. Car, 318, 340, 360 w/o AC.....	33.99 ea
B4713	1970	Chrysler Pass. Car, 383, 440.....	33.99 ea
B4710E	1971	Chrysler Pass. Car, 318, 340, 360 w/o AC.....	33.99 ea
B4711E	1971	Chrysler Pass. Car, 318, 340, 360 w/o AC.....	33.99 ea

B4713E	1971	Chrysler Pass. Car, 383, 440.....	36.99 ea
B4750	1972	Chrysler Pass. Car, 318, 340, 360 w/o AC.....	36.99 ea
B4751	1972	Chrysler Pass. Car, 400, 440 (42 1/2").....	36.99 ea
B4751	1972	Chrysler Pass. Car, 400, 440 w/AIR, w/AC.....	36.99 ea
B4752	1972	Chrysler Pass. Car, 400, 440 w/o AIR, w/AC.....	36.99 ea
B4610	1969	Dart, 318, 340 (42").....	33.99 ea
B4612	1969	Dart, 273, 318, 340 w/o AC.....	33.99 ea
B4614	1969	Dart, 383, 440 (43").....	33.99 ea
B4616	1969	Dart, 383, 440 (42 1/2").....	33.99 ea
B4710	1970	Dart, 318, 340, 360 w/o AC.....	33.99 ea
B4711	1970	Dart, 318, 340, 360 w/o AC.....	33.99 ea
B4710E	1971	Dart, 318, 340, 360 w/o AC.....	33.99 ea
B4711E	1971	Dart, 318, 340, 360 w/o AC.....	33.99 ea
B4750	1972	Dart, 318, 340, 360 w/o AC.....	36.99 ea
B4741	1972	Dart, 318, 340, 360 w/o AC.....	33.99 ea
B4610	1969	Dodge/Ply, 318, 340 (42").....	33.99 ea
B4612	1969	Dodge/Ply, 273, 318, 340 w/o AC (42 1/2).....	33.99 ea
B4613	1969	Dodge/Ply, 383, 440 (44").....	36.99 ea
B4614	1969	Dodge/Ply, 383, 440 (43").....	33.99 ea
B4616	1969	Dodge/Ply, 383, 440 (42 1/2").....	33.99 ea
B4615	1969	Dodge/Ply, 383, 440 (42 1/2").....	36.99 ea
B4710	1970	Dodge/Ply, 318, 340, 360 w/o AC.....	33.99 ea
B4711	1970	Dodge/Ply, 318, 340, 360 w/o AC.....	33.99 ea
B4713	1970	Dodge/Ply, 383, 440 (42 1/2").....	33.99 ea
B4710E	1971	Dodge/Ply, 318, 340, 360 w/o AC.....	33.99 ea
B4711E	1971	Dodge/Ply, 318, 340, 360 w/o AC.....	33.99 ea
B4713E	1971	Dodge/Ply, 383, 440 (42 1/2").....	36.99 ea
B4750	1972	Dodge/Ply, 318, 340, 360 w/o AC.....	36.99 ea
B4741	1972	Dodge/Ply, 318, 340, 360 w/o AC.....	33.99 ea
B4751	1972	Dodge/Ply, 400, 440.....	36.99 ea
B4752	1972	Dodge/Ply, 400, 440 w/AC, w/AIR (46").....	36.99 ea
B4610	1969	Valiant, 318, 340 (42").....	33.99 ea
B4612	1969	Valiant, 273, 318, 340 w/o AC (42 1/2").....	33.99 ea
B4710	1970	Valiant, 318, 340, 360 w/o AC.....	33.99 ea
B4711	1970	Valiant, 318, 340, 360 w/o AC.....	33.99 ea
B4710E	1971	Valiant, 318, 340, 360 w/o AC.....	33.99 ea
B4711E	1971	Valiant, 318, 340, 360 w/o AC.....	33.99 ea
B4750	1972	Valiant, 318, 340, 360 w/o AC.....	36.99 ea
B4741	1972	Valiant, 318, 340, 360 w/o AC.....	33.99 ea



8016301

1968-74 Rack And Pinion Conversion Steering Systems

Installing this rack and pinion will bring a 1968-74 Mopar B or E-Body steering system up to modern day standards of control and response. Designed specifically to match the front suspension of the B or E-Body platform to minimize bump steer. Each set includes power rack and pinion, pump kit, steering shaft kit and brackets and hardware for mounting and steering column modification. Will work with the stock steering column. All rack and pinions are pre-assembled and centered for easy installation. Available powder coated black or chrome.

Important: Factory exhaust manifolds or B-7s kits are recommended for these kits; other hangers may work but are not guaranteed to work with this kit.
Note: Shipped double oversize.

		B-Body		
8017301	1968-72	small block	black	1294.99 set
8017302	1968-72	small block	chrome	1589.99 set
8016301	1968-72	big block	black	1294.99 set
8016302	1968-72	big block	chrome	1414.99 set
		E-Body		
8016601	1970-74	small block	black	949.99 set
8016602	1970-74	small block	chrome	1199.99 set
8016701	1970-74	big block	black	1294.99 set
8016702	1970-74	big block	chrome	1401.99 set

Steering Components

Is your steering loose or front end out of alignment? Parts of your steering system may be worn out or damaged. Now you can rebuild your 1962-76 Mopar A, B or E-Body's steering linkage system with your choice of inexpensive aftermarket replacement parts or superior

premium replacement parts, both of which meet or exceed OE quality standards. Whether it's loose tie rod ends, a seized-up idler arm, or a worn out steering gear box, we carry the parts you need to get your Mopar back on the road!

1962-76 Steering Components

Choose part numbers ending in (A) for standard service replacement parts, or part numbers ending in (B) for Restorer's Choice components, where available.

Outer Tie Rod Ends

Two outer tie rods are required per vehicle.

A-Body

ES319RA 1962-69	all	23.99 ea
ES319RB 1962-69	all	54.99 ea
ES401RA 1970-76	all	11.99 ea
ES401RB 1970-76	all	19.99 ea

B-Body

ES319RA 1962-69	all	23.99 ea
ES319RB 1962-69	all	54.99 ea
ES401RA 1970-74	all	11.99 ea
ES401RB 1970-74	all	19.99 ea

E-Body

ES401RA 1970-74	all	11.99 ea
ES401RB 1970-74	all	19.99 ea

Inner Tie Rod Ends

Two inner tie rods are required per vehicle.

A-Body

ES319LA 1962-69	all	23.99 ea
ES319LB 1962-69	all	50.99 ea
ES401LA 1970-76	all	11.99 ea
ES401LB 1970-76	all	34.99 ea

B-Body

ES319LA 1962-69	all	23.99 ea
ES319LB 1962-69	all	50.99 ea
ES401LA 1970-74	all	11.99 ea
ES401LB 1970-74	all	34.99 ea

E-Body

ES401LA 1970-74	all	11.99 ea
ES401LB 1970-74	all	34.99 ea

Adjusting Sleeve

Choose part numbers ending in (A) for standard service replacement parts, or part numbers ending in (B) for Restorer's Choice components, where available. Two adjusting sleeves required per vehicle.

A-Body

ES319SA 1962-69	all	15.99 ea
ES319SB 1962-69	all	29.99 ea

B-Body

ES319SA 1962-72	all	15.99 ea
ES319SB 1962-72	all	29.99 ea
ES430SA 1973-74	all	16.99 ea
ES430SB 1973-74	all	34.99 ea

E-Body

ES319SA 1970-74	all	15.99 ea
ES319SB 1970-74	all	29.99 ea

Idler Arm

Choose part numbers ending in (A) for standard service replacement parts, or part numbers ending in (B) for Restorer's Choice components, where available.

A-Body

MK414B 1962-66	all	49.99 ea
2021B 1967	all	174.99 ea

B-Body

K7042A 1968-72	all	22.99 ea
K7042B 1968-72	all	44.99 ea
K7086A 1973-76	all	19.99 ea
K7086B 1973-76	all	34.99 ea

E-Body

K779A 1962-67	all	40.99 ea
K779B 1962-67	all	54.99 ea
K7041A 1968-72	all	46.99 ea
K7041B 1968-72	all	59.99 ea
K7066A 1973-74	all	47.99 ea
K7066B 1973-74	all	89.99 ea

E-Body

K7041A 1970-74	all	46.99 ea
K7041B 1970-74	all	59.99 ea



ES319RA



ES319SA



ES401RA



K7042B



K7042B

Pitman Arm

Choose part numbers ending in (A) for standard service replacement parts, or part numbers ending in (B) for Restorer's Choice components, where available.

* Not for 1965 power steering equipped vehicles w/10.45-10.51" shaft and 1-1/4" sector.

A-Body

K20101* 1962-70	all	129.99 ea
K7074A 1967-72	all, small block	69.99 ea
K7074B 1967-72	all, small block	88.99 ea
20492 1967-69	all, 383	107.99 ea
K7075A 1973-76	all, manual steering	39.99 ea
K7075B 1973-76	all, manual steering	56.99 ea
K7076A 1973-76	all, power steering	32.99 ea
K7076B 1973-76	all, power steering	49.99 ea

B-Body

K20101* 1962-70	all	147.99 ea
20144 1971-72	all	152.99 ea
K7075A 1973-76	all, manual steering	39.99 ea
K7075B 1973-76	all, manual steering	56.99 ea
K7076A 1973-74	all, power steering	32.99 ea
K7076B 1973-74	all, power steering	49.99 ea

E-Body

20144 1970-72	all exc AAR	152.99 ea
K7075A 1973-74	all, manual steering	39.99 ea
K7075B 1973-74	all, manual steering	56.99 ea
K7076A 1973-74	all, power steering	32.99 ea
K7076B 1973-74	all, power steering	49.99 ea



1966-76 Manual Steering Box

Brand new Mopar replacement manual steering box for 1966-76 A, B, and E-Body models manufactured by Flaming River*. Here is the answer to that sloppy old manual steering box. This small sector steel box features stronger parts than the original plus a quicker ratio (16:1). This unit will give you quicker turning and a feeling of more control of your Mopar. This steering box has a smaller sector and a smaller pitman arm may be required.

Note: No further discounts apply.

MD2195 1966-76	all	629.99 ea
----------------	-----	-----------



Front Suspension Components

If your suspension rattles or makes noises when turning or going over bumps, it might be time to think about rebuilding your front suspension. You no longer have to search for obsolete parts because we carry the parts you need to rebuild the suspension of your 1962-76

A, B or E-Body. Choose from either standard aftermarket replacement parts or premium replacement parts, both of which meet or exceed OE quality standards. Whether it's cracked bushings, or rusty spindles, we carry the parts you need to get your Mopar on the road again!



K785B



K704B



K7030B



513102G



H21366



Made in USA

1962-76 Polyurethane Dust Boots

Replace your old rubber dust boots with polyurethane dust boots for better wear and protection from the elements and road debris. Available in black or red polyurethane, please specify color when ordering. Made in USA.

Note: Add "G" to part number for black, "R" for red.

Ball Joint Dust Boots

513102	1962-76	A-Body	9.99	set
513102	1965-76	B-Body	4.99	pr
513102	1970-74	E-Body	4.99	pr

Tie Rod Dust Boots-OE Style

913101	1962-76	A-Body	4.99	pr
913101	1965-76	B-Body	4.99	pr
913101	1970-74	E-Body	4.99	pr

Torsion Bar Boots

513101	1962-76	A-Body	9.99	pr
513101	1965-76	B-Body	9.99	pr
513101	1970-74	E-Body	9.99	pr



Hotchkis Lower Control Arm Bushings

When upgrading your front suspension components on your classic Mopar remember to upgrade your lower control arm bushings with Hotchkis lower control arm bushings. These complement the other Hotchkis Sport Suspension components in tightening up the handling performance and highly recommended when installing Hotchkis front end components. Includes a pair of polyurethane bushings and grease for a direct replacement of the stock rubber bushings. Made in USA.

Note: No further discounts apply.

H21366	1967-76	A-Body	29.99	pr
H21366	1966-70	B-Body	29.99	pr
H21366	1970-74	E-Body	29.99	pr



1960-76 Front Suspension Components

Front Suspension components for 1960-76 Mopar A-Body, B-Body and E-Body models. Get your Mopar's front suspension back in shape with all the components needed to refurbish your control arms.

Upper Control Arm Ball Joints

Two upper control arm ball joints are required per car. Choose either OE replacement (A) or Restorer's Choice (B) components.

A-Body				
K704A	1960-72	all	26.99	ea
K704B	1960-72	all	39.99	ea
K772B	1973-76	all	19.99	ea
B-Body				
K772B	1962-74	all	19.99	ea
E-Body				
K772B	1970-74	all	19.99	ea

Lower Control Arm Ball Joints - LH

Includes lower ball joint and steering arm. Choose either OE replacement (A) or Restorer's Choice (B) components.

A-Body				
K787A	1960-72	all w/drum brakes	76.99	ea
K787B	1960-72	all w/drum brakes	84.99	ea
MK7023B	1960-72	all w/disc brakes	78.99	ea
K783A	1973-76	all	39.99	ea
K783B	1973-76	all	49.99	ea
B-Body				
K783A	1962-72	all	39.99	ea
K783B	1962-72	all	49.99	ea
E-Body				
K783A	1970-74	all	39.99	ea
K783B	1970-74	all	49.99	ea

Lower Control Arm Ball Joints - RH

Includes lower ball joint and steering arm. Choose either OE replacement (A) or Restorer's Choice (B) components.

A-Body				
K785B	1960-72	all w/drum brakes	84.99	ea
MK7021B	1960-72	all w/disc brakes	74.99	ea
MK781A	1973-76	all	39.99	ea
MK781B	1973-76	all	49.99	ea
B-Body				
MK781A	1962-72	all	39.99	ea
MK781B	1962-72	all	49.99	ea
E-Body				
MK781A	1970-74	all	39.99	ea
MK781B	1970-74	all	49.99	ea

Upper Control Arm Shaft Kit

Includes cam bolts and cam shims. Two kits are required per car.

K7030B	1960-76	all models	34.99	kit
--------	---------	------------	-------	-----

Upper Control Arm 4 Piece Bushing Set

Includes all four bushings to refurbish your upper control arms. Add suffix (A) for replacement parts or (B) for Restorer's Choice parts.

MK408A	1960-72	all models	14.99	set
MK408B	1960-72	all models	30.99	set
MK408A	1973-76	A-Body models	14.99	set
MK408B	1973-76	A-Body models	30.99	set
K7058A	1973-76	B-Body models	13.99	set
K7058B	1973-76	B-Body models	29.99	set

Lower Control Arm Bushing

Lower control arm bushing to refurbish 1 lower control arm (2 required). Choose either OE replacement (A) or Restorer's Choice (B) components.

K791A	1960-72	all models	8.99	ea
K791B	1960-72	all models	13.99	ea
K7059A	1973-76	B-Body models	6.99	ea
K7059B	1973-76	B-Body models	12.99	ea
K791A	1973-76	A-Body	8.99	ea
K791B	1973-76	B-Body	13.99	ea

Steering/Suspension



MD7792

1966-72 B & E-Body Front End Rebuild Set

Restore the handling of your 1966-72 Mopar B-Body or E-Body and reduce front tire wear with these rebuild sets. These sets will renew your worn out front suspension with all new components. Each set includes upper and lower ball joints, inner and outer tie rod ends with the rod adjusting sleeves, upper and lower control arm bushings and strut rod bushings for a complete replacement.

- 2 **Upper Ball Joints**
- 2 **Tie Rod Adjusting Sleeves**
- 2 **Lower Ball Joints**
- 4 **Lower Control Arm Bushings**
- 2 **Inner Tie Rods**
- 4 **Upper Control Arm Bushings**
- 2 **Outer Tie Rods**
- 4 **Strut Rod Bushings**

B-Body Models

MD7792 1966-69 B-Body..... 209.99 set

MD7793 1970-72 B-Body..... 209.99 set

E-Body Models

MD7793 1970-72 E-Body..... 209.99 set



Mopar B & E Body Ball Joint Removal Tool

This 1/2" drive ball joint tool makes replacing ball joints on your B or E-Body Mopar a breeze.

Note: No further discounts apply.

H32102 B & E-Body..... 31.99 ea



1966-76 Quick Ratio Idler & Pitman Arm

This quick ratio idler and pitman arm set from Hotchkis upgrades the steering on your A, B, or E-Body from the factory 16:1 ratio to a quick, responsive 12:1 ratio. This simple, bolt-on upgrade brings your steering to the performance level of the legendary AAR Cuda and TA Challengers. The idler and pitman arm feature forged, heat-treated housings and ball studs for durability and are finished in black e-coat to prevent corrosion. This is a must-have upgrade for any performance car. Made in the USA.

Important: May not clear some aftermarket headers. 1967-72 A-body models require 1973-76 A-body center link and spindles.

Note: No further discounts apply.

H3004 1967-76 A-Body..... 299.99 set

H3004 1966-72 B-Body..... 299.99 set

H3004 1970-74 E-Body..... 299.99 set



H3005

1962-76 Greasable Heavy Duty Pivot Shaft and Bushing Set

This set from Hotchkis is the solution to sloppy handling caused by worn pivot shafts. Direct replacements for A, B, or E-Body Mopar models, these greasable shafts offer convenience and performance by reducing friction and suspension bind. Includes two greasable shafts, polyurethane bushings and grade 8 hardware.

Note: No further discounts apply.

H3005 1965-76 A-Body..... 129.99 set

H3006 1962-72 B-Body..... 129.99 set

H3006 1970-74 E-Body..... 129.99 set



MD47210

1963-76 Tubular Tie Rod Adjuster Sleeves

These tubular tie rod adjusting sleeves are used in performance applications to provide full, 360° thread engagement on inner and outer tie rod threads. They are locked in position with jam nuts to stop the sleeve from rotating. Rather than a special tool, an open-end wrench is used for adjustments. Designed to seal out dirt and water and provide superior holding under hard cornering.

Note: No further discounts apply.

MD47209 1963-76 A-Body..... 61.99 pr

MD47209 1965-72 B-Body..... 61.99 pr

MD47210 1973-75 B-Body..... 61.99 pr

MD47209 1970-74 E-Body..... 61.99 pr



H16385



1966-76 Hotchkis Steering Links

Install these Hotchkis rods on your 1966-76 Mopar and significantly improve your handling and control. These are designed to be used in conjunction with Hotchkis Sport Suspension A-Arms to reduce bump steer to improve response and driver control. With adjustability in mind the steering rods feature 58" high articulation rod ends, lightweight aluminum 1" HEX adjustable sleeves and is powder coated with a "Nickel Look" finish.

Note: No further discounts apply.

H16385 1967-76 A-Body..... 329.99 pr

H16366 1966-70 B-Body..... 329.99 pr

H16366 1970-74 E-Body..... 329.99 pr



STEERING, SUSPENSION, REAR END & BRAKES

Steering/Suspension



1966-76 Hotchkis Adjustable Strut Rods

Install these adjustable strut rods on your 1966-76 Mopar and dramatically improve handling and control. These 100% TIG welded, bolt-on adjustable strut arms positively locate the lower arm to improve caster, responsiveness and driver control. Features 5/8" high articulation rod ends, CNC bent brackets, and lightweight TIG welded 7/8" tubing. These are finished in a lustrous, "Nickel Look" powder coat finish.

Note: No further discounts apply.

H14385	1967-76	A-Body	309.99 pr
H14366	1966-70	B-Body	309.99 pr
H14366	1970-74	E-Body	309.99 pr



1960-76 Adjustable Strut Rods

When using polyurethane bushings on stock strut rods, factory caster settings are often lost. Instead, use these adjustable strut rods for A, B, or E-Body models, CNC machined from 3/4", 1144 stress relieved, cold drawn steel with a tensile strength in excess of 100,000 psi, then black oxide coated for rust protection. Stock in appearance; these can be installed as purchased, painted or powder coated. Includes strut rods, custom polyurethane bushings, hardware, and instructions. Made in the USA.

MN42200	1960-76	A-Body	249.99 set
MN42200	1965-72	B-Body	249.99 set
MN42200	1970-74	E-Body	249.99 set



1962-74 B & E-Body Spindles with Disc Brake Brackets

These reproduction spindles for B & E-Body models are designed for stock ride height and will fit and function on drum brake vehicles as original. With the included brackets, disc brake callipers may be used.

MM3068	1962-74	B-Body	249.99 pr
MM3068	1970-74	E-Body	249.99 pr



1963-74 A-Body Disc Brake Conversion Tubular Upper Control Arm Set

These tubular upper control arm sets are designed for installing B and E-Body disc brakes on your A-Body Mopar. They are made from 1-1/4", 120" wall D.O.M. tubing. The pivot barrels are thick 1-1/2" .188" wall D.O.M. tubing to eliminate distortion from welding and hard use. The bushings are made from self-lubricating non-squeak plastic that works at temperatures in excess of 400°F and will outlast any rubber or urethane. The sleeves are zinc plated for lasting performance, and ball joints are included.

MN6002	1963-74	A-Body	399.99 set
--------	---------	--------	------------



1963-74 A-Body Disc Brake Conversion Upper Control Arm Set

These original quality stamped steel upper control arm sets are a must when installing 1973-76 B and E-Body disc brakes on your A-Body Mopar. Includes bushings and ball joints. Sold in sets.

MN6001	1963-74	A-Body	299.99 set
--------	---------	--------	------------



1963-74 B & E-Body Upper Control Arms

These tubular upper control arms are designed to bolt-on to the upper factory mount for B and E-Body models. They are made from 1-1/4", 120" wall D.O.M. tubing. The pivot barrels are thick 1-1/2" .188" wall D.O.M. tubing to eliminate distortion from welding and hard use. The bushings are self-lubricating non-squeak plastic that works at temperatures in excess of 400°F and will outlast any rubber or urethane. The sleeves are zinc plated for lasting performance, and ball joints are included. Sold in pairs.

MN6000	1963-74	B & E-Body	349.99 pr
--------	---------	------------	-----------



1962-74 B & E-Body Upper Control Arms

Upper control arms for 1962-72 B-Body and 1970-74 E-Body models. Why take the time to press out those worn bushings or ball joints when you can replace them with new replacement upper control arms that include new bushings, ball joints and new metal. This will help improve your handling but still retain an original appearance.

ME1617	1962-74	RH	139.99 ea
ME1618	1962-74	LH	139.99 ea



H1112



H1110



1967-76 Hotchkis Tubular Upper Control Arms

Install these geometry-corrected Hotchkis Tubular Upper A-Arms on your 1966-76 Mopar and drastically improve handling and control. These 100% TIG welded, bolt-on arms offer an improved camber curve, and increased caster. Upper arms feature TIG welded 1-1/8" high-strength tubing with Laser cut reinforcement gussets, high quality, 5/8" high articulation rod ends and premium ball joints and Laser cut, CNC bent in relocation bracket corrects excessive caster gain. Control arms are finished in a durable, "Nickel Look" powder coat finish. Made in USA.

Important: 1967-72 A-Body can use PIN H1112 if wishing to upgrade to 1975-76 "big ball joint" spindles.

Note: No further discounts apply.

H1112S	1967-72	A-Body	659.99 pr
H1112	1973-76	A-Body	649.99 pr
H1110	1966-70	B-Body	739.99 pr
H1110	1970-74	E-Body	739.99 pr



Suspension Components

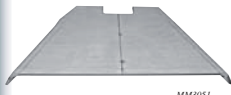

MM3051



MM3052



MM3052



Made in USA

1967 Style Oil Pan Skid Plates

Aftermarket replacement style wedge-shaped skid plate for 1967 models. Manufactured in 3/16" stamped steel, these plates feature either a 1" or 2.5" drop for stock or high-capacity oil pan protection. Made in USA.

- 1" Drop Skid Plate**
MM3051 1967 stock Hemi 129.99 set
2.5" Drop Skid Plate
MM3052 1967 Hemi w/8 qt. oil pan... 179.99 set



MN1600



MN1601



MN1603

1960-76 Factory Torsion Bar Sets

Factory Mopar torsion bar sets for the restored or performance Mopar. Designed to upgrade the handling performance of the vehicle and provide better weight transfer. Direct replacement of the stock torsion bar without modifications. The A-Body bars are 35.70" long; B and E-body bars are 41" long. Sold in pairs.

- A-Body**
MN1600 1960-76 0.810" 459.99 pr
MN1601 1960-76 0.890" w/383 459.99 pr
MN1602 1960-76 0.920" racing 459.99 pr
B-Body
MN1603 1962-72 0.920" 440/Hemi ... 319.99 pr
MN1604 1962-72 0.960" Hemi..... 309.99 pr



1962-76 Poly Control Arm Bump Stops

Replace those broken or missing control arm bumper stops with new polyurethane bumper stops. Sold in pairs. Available in black (G) or red (R). Specify color when ordering. Made in USA.

- Upper Control Arm**
99103 1962-76 A-Body 9.99 pr
99103 1965-76 B-Body 9.99 pr
99103 1970-74 E-Body 9.99 pr
Lower Control Arm
99119 1962-76 A-Body 9.99 pr
99119 1965-76 B-Body 9.99 pr
99119 1970-74 E-Body 9.99 pr



1960-74 Torsion Bar Lock and Seal

Mopar Performance torsion bar lock and seal for 1960-74 A-Body, 1962-74 B-Body and all E-Body models. Includes two boots and two clips. Clips are also available separately in pairs.

- Torsion Lock and Seal**
MN1605 1960-74 all 34.99 set
Clips
MN1606 1960-74 all 9.99 pr



1965-74 Hotchkis Torsion Bars

Improve handling performance and control with a pair of premium quality torsion bars from Hotchkis. These .103" bars offer increased vehicle control and maintain a comfortable ride. The set includes a pair of forged, heat-treated torsion bars, polyurethane seals, and retaining clips. Made in the USA.

- Note: No further discounts apply.**
H19367 1965-74 B-Body 369.99 set
H19367 1970-74 E-Body 369.99 set



Y41500



Y56750



Y41900

Steering & Suspension Tools

Pickle fork set separates ball joints, tie rods, pitman arms and other suspension items that are difficult to separate. 5 piece set. Seal puller is great for pulling oil or grease seals. Pitman arm puller will make replacing the pitman arm easy and is designed to pull pitman arms from most cars and trucks.

- Y41500 pickle fork set, 5 piece 59.99 set
Y56750 seal puller 11.99 ea
Y41900 pitman arm puller 32.99 ea



MN4202

1960-76 Sway Bar Link Hardware

Do you have a bushing set, but need the sway bar link hardware? This set includes the bolts, nuts, washers, and spacers. Available in short (2-3/4") or long (3-3/4"). Made in the USA.

- Sway Bar End Link with Bushings**
18048N 1970-76 all - 2 required 7.99 set
Short Sway Bar Link - 2-3/4"
MN42201 1960-76 A-Body 44.99 set
MN42201 1965-76 B-Body 44.99 set
MN42201 1970-74 E-Body 44.99 set
Long Sway Bar Link - 3-3/4"
MN42202 1960-76 A-Body 44.99 set
MN42202 1965-76 B-Body 44.99 set
MN42202 1970-74 E-Body 44.99 set



1970-72 E-Body Front Sway Bar Brackets

Correct replacement U-shaped front sway bar brackets needed for 1970-72 Mopar E-Body models.

- MN1869 1970-72 E-Body 29.99 pr

Sway Bars



1960-74 ADDCO Reproduction Sway Bar Sets

RSB919

Replace your original sway bar with these brand new bars and get your suspension working like it did when new. These reproduction sway bars for 1960-74 models come complete with sway bar bushings and mounting brackets as shown. Made in USA.
Note: Shipped overseas.

Front Sway Bars

A-Body					SET
FSB142	1960-61	Valiant	front 7/8"	179.99 set
FSB751	1962-66	all	front 1-1/8"	179.99 set
FSB150	1967-72	all	front 1-1/8"	188.99 set
FSB186	1973-74	Duster, Valiant	front 1"	204.99 set
B-Body					
FSB541	1962-64	Polaris	front 1-1/8"	164.99 set
FSB541	1965-69	Plymouth	front 1-1/8"	164.99 set
FSB541	1965-69	Charger, Coronet	front 1-1/8"	164.99 set
FSB149	1970	all	front 1"	193.99 set
FSB186	1971-72	all	front 1"	204.99 set
FSB806	1973-74	all	front 1-1/8"	214.99 set
E-Body					
FSB149	1970-74	all	front 1"	193.99 set

Rear Sway Bars

A-Body					SET
RSB919	1960-66	all	rear 3/4"	129.99 set
B-Body					
RSB919	1962-64	Polaris	rear 3/4"	129.99 set
RSB919	1965-70	Plymouth	rear 3/4"	129.99 set
RSB919	1965-69	Charger, Coronet	rear 3/4"	129.99 set
RSB919	1970	Charger, Coronet	rear 3/4"	129.99 set
RSB236	1971-72	Charger, Coronet	rear 3/4"	159.99 set
RSB236	1971-74	Plymouth	rear 3/4"	159.99 set
RSB236	1973-74	Charger	rear 3/4"	159.99 set
E-Body					
RSB261	1970-74	all	rear 3/4"	179.99 set



1963-76 Hellwig Motorsports Sway Bars

MB6009

Hellwig front sway bars feature 3-point adjustment to tailor-fit your suspension and are made from high-strength tubular DOM steel for maximum performance with half the weight. Rear sway bars made from heat-treated 4140 chromoly spring steel. These sway bars utilize high-strength polyurethane bushings, heavy-duty zinc plated hardware, and feature a durable powdercoated finish. Larger-than-stock diameters optimize handling and reduce body roll.
Note: Rear Sway Bar requires drilling. Shipped overseas.

Tubular Front Sway Bars

A-Body					SET
MA3460	1963-66	1-1/4" diameter		238.99 set
MA4704	1967-72	1-1/8" diameter		224.99 set
MA4705	1973-76	1-1/8" diameter		164.99 set
B-Body					
MB6009	1964-69	1-3/8" diameter		229.99 set
MD7060	1970-72	1-1/4" diameter		174.99 set
E-Body					
MD7060	1970-74	1-1/4" diameter		174.99 set

Rear Sway Bars

A-Body					SET
MAA4706	1963-76	3/4" diameter		214.99 set
B-Body					
ME2660	1964-70	7/8" diameter		224.99 set
ME2659	1971-72	7/8" diameter		231.99 set
E-Body					
ME1755	1970-74	7/8" diameter		194.99 set



H22385C



H22386R



H2254F



1966-74 Hotchkis Sway Bars

Improve the handling and straight line performance of your Mopar with Hotchkis Sport Suspension stabilizer bars. Specifically tuned and tested for each application to offer a balanced feel. Hotchkis Sport Suspension stabilizer bars offer increased roll stiffness previously unavailable for the classic Mopar. Both stock vehicles and those modified with wider tires and high horsepower engines will benefit from this increased stability. Featuring the latest, lightweight tubular design, these bars are finished in gloss black powder coat, and include easy to lubricate bushings, mounts, and end links, and all necessary hardware for a complete installation.

Important: A-Body models require minor welding. B-Body models may require minor frame drilling in rear.

*Note: *Lower mounts for vehicles without original sway bar mounts. Shipped overseas. No further discounts apply.*

A-Body					SET
H22385F	1967-72	front 1-1/2"		304.99 ea
H22385R	1967-72	rear 1" adjustable		299.99 ea
H22385C	1967-72	1-1/2" front and 1" rear adjustable		609.99 set
H22386F	1973-76	front 1-1/4"		329.99 ea
H22386R	1973-76	rear 1" adjustable		309.99 ea
H22386C	1973-76	1-1/4" front and 1" rear adjustable		629.99 set
B-Body					
H2255F	1966-70	front 1-1/2"		309.99 ea
H2255R	1966-70	rear 1" adjustable		369.99 ea
H2255C	1966-70	1-1/2" front and 1" rear adjustable		649.99 set
E-Body					
H2254F	1970-74	front 1-1/4"		309.99 ea
H2254R	1970-74	rear 3/4" adjustable		369.99 ea
H2254C	1970-74	front 1-1/4" and rear 3/4" adjustable		649.99 set
B-Body & E-Body Lower Sway Bar Mounts					
H23366*	1966-69	lower mounts, use with H2255C, H2255F		39.99 pr
H23367*	1970-74	lower mounts, use with H2254C, H2254F		39.99 pr



Suspension Bushings



1962-76 Prothane Bushing Sets

These polyurethane bushings are designed to improve suspension performance without the noise vibration and harshness that polyurethane is known for. All dynamic bushings feature grooves to hold the grease for greater performance and each set includes "squeak proof" Super Grease. Please specify color when ordering (G-black or R-red).

1962-76 Complete Sets

MN42001	1962-76	A-Body	239.99 set
MN42001	1965-72	B-Body	239.99 set
MN42001	1970-74	E-Body	239.99 set

Lower Control Arm Bump Stops

MN191303	1962-76	A-Body	9.99 set
MN191303	1965-76	B-Body	9.99 set
MN191303	1970-74	E-Body	9.99 set

Control Arm Bushings

MN42020	w/o shells upper only	19.99 set
MN42050	w/o shells lower only	11.99 set
MN42060	w/o shells upper/w/ lower	29.99 set
MN42150	w/shells upper/w/ lower	59.99 set
MN42020	w/o shells upper only	19.99 set
MN42050	w/o shells lower only	11.99 set
MN42060	w/o shells upper/w/ lower	29.99 set
MN42150	w/shells upper/w/ lower	59.99 set

B-Body - 1973-76

MN42070	w/o shells upper/w/ lower	29.99 set
MN42070	w/o shells upper only	19.99 set
MN42050	w/o shells lower only	11.99 set
MN42060	w/o shells upper/w/ lower	29.99 set
MN42150	w/shells upper/w/ lower	59.99 set

Strut Arm Bushings

MN41202	1962-76	A-Body	19.99 set
MN41207	1965-72	B-Body	19.99 set
MN41207	1970-74	E-Body	19.99 set

Sway Bar Bushings

MN41104	1967-72	7/8"	14.99 set
MN41105	1965-72	15/16"	14.99 set
MN41107	1973-76	13/16"	14.99 set
MN41108	1973-76	7/8"	14.99 set
MN41109	1973-76	15/16"	14.99 set
MN41104	1965-69	7/8"	14.99 set
MN41105	1965-72	15/16"	14.99 set
MN41106	1973-76	13/16" w/end links	29.99 set
MN41116	1973-76	15/16" w/end links	29.99 set
MN41108	1970-74	7/8"	14.99 set

Sway Bar End Links

MN19408	1965-72	4-1/4"	mntg lngh.	19.99 set
MN19405	1973-76	3-1/4"	mntg lngh.	19.99 set

Tie Rod Boats

MN191712	1962-76	all models	4.99 pr
----------	---------	------------	---------

Torsion Bar Crossmember Mount Set

MN41060	1973-76	B-Body	21.99 set
---------	---------	--------	-----------

Torsion Bar Dust Boots

MN41701	1962-76	all models	5.99 pr
---------	---------	------------	---------

ADJUST-A-LINK

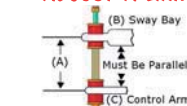

1962-76 Hyper-Flex Poly Bushing Sets

These Energy Suspension bushing sets make it easy to replace worn rubber components and upgrade your handling. These sets contain the major suspension bushing components. Mixing standard rubber bushings with polyurethane bushings is not recommended, so, if you are going to replace any of the suspension bushings, then replace them all. Available in black or red. Made in USA.
Note: 1966-76 sets do not include sway bar bushings due to the various bar sizes.

1965-76 Complete Bushing Sets

A-Body	518104G*	1966-76	all black	156.99 set
A-Body	518104R*	1966-76	all red	156.99 set
B-Body	518105G	1965-72	all black	151.99 set
B-Body	518105R	1965-72	all red	151.99 set
E-Body	518105G	1970-74	all black	151.99 set
E-Body	518105R	1970-74	all red	151.99 set

Front Stabilizer Link Kit

A-Body	98118G	1962-72	all black	19.99 set
A-Body	98118R	1962-72	all red	19.99 set
B-Body	98120G	1973-76	all black	19.99 set
B-Body	98120R	1973-76	all red	19.99 set
B-Body	98118G	1965-69	all black	19.99 set
B-Body	98118R	1965-69	all red	19.99 set
B-Body	98120G	1970-72	all black	19.99 set
B-Body	98120R	1970-72	all red	19.99 set
E-Body	98120G	1970-74	all black	19.99 set
E-Body	98120R	1970-74	all red	19.99 set

Strut Rod Bushing Kit

A-Body	57105G	1962-65	all black	13.99 kit
A-Body	57105R	1962-65	all red	13.99 kit
B-Body	57109G	1966-76	all black	19.99 kit
B-Body	57109R	1966-76	all red	19.99 kit
B-Body	57109G	1965-74	all black	19.99 kit
B-Body	57109R	1965-74	all red	19.99 kit
E-Body	57109G	1970-74	all black	19.99 kit
E-Body	57109R	1970-74	all red	19.99 kit

13/16" Sway Bar To Frame Bushing

A-Body	55112G	1973-76	all	11.99 pr
A-Body	55112R	1973-76	all	11.99 pr
B-Body	55136G	1973-76	all	24.99 set
B-Body	55136R	1973-76	all	24.99 set

7/8" Sway Bar To Frame Bushing

A-Body	55128G	1967-72	all	14.99 pr
A-Body	55128R	1967-72	all	14.99 pr
A-Body	55134G	1967-72	all, greaseable	44.99 set
A-Body	55134R	1967-72	all, greaseable	44.99 set
A-Body	55135G	1973-76	all, greaseable	11.99 pr
A-Body	55113R	1973-76	all	11.99 pr
B-Body	55128G	1965-69	all	14.99 pr
B-Body	55128R	1965-69	all	14.99 pr
B-Body	55134G	1965-69	all, greaseable	44.99 set
B-Body	55134R	1965-69	all, greaseable	44.99 set
B-Body	55113G	1970-72	all	11.99 pr
B-Body	55113R	1970-72	all	11.99 pr
E-Body	55113G	1970-74	all	11.99 pr
E-Body	55113R	1970-74	all	11.99 pr

15/16" Sway Bar To Frame Bushing

A-Body	55129G	1967-72	all	14.99 pr
A-Body	55129R	1967-72	all	14.99 pr
A-Body	55135G	1967-72	all, greaseable	44.99 set
A-Body	55135R	1967-72	all, greaseable	44.99 set
A-Body	55115G	1973-76	all	11.99 pr
A-Body	55115R	1973-76	all	11.99 pr

B-Body	55129G	1965-69	all	14.99 pr
B-Body	55129R	1965-69	all	14.99 pr
B-Body	55134G	1965-69	all, greaseable	44.99 set
B-Body	55134R	1965-69	all, greaseable	44.99 set
B-Body	55115G	1970-72	all	11.99 pr
B-Body	55115R	1970-72	all	11.99 pr
B-Body	55142G	1973-76	all	24.99 set
B-Body	55142R	1973-76	all	24.99 set
E-Body	55115G	1970-74	all	11.99 pr
E-Body	55115R	1970-74	all	11.99 pr

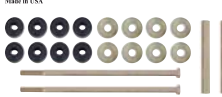

Adjustable Polyurethane End Links

Handling and stability just got a lot easier with Energy's Adjust-A-Link. The end links include two different height bushings which enable you to mix and match to obtain the optimal length. Each set number offers 1/2" of adjustment in 1/4" increments. Energy's Adjust-A-Link will accommodate lengths of 2-3/4" to 6-3/8" with no coverage gaps. Made in USA.

Black

98162G	2-3/4" - 3-1/4"	70mm-83mm	19.99 set
98163G	3-3/8" - 3-7/8"	86mm-99mm	19.99 set
98164G	4" - 4-1/2"	102mm-115mm	19.99 set
98165G	4-5/8" - 5-1/8"	117mm-130mm	19.99 set
98166G	5-1/4" - 5-3/4"	133mm-146mm	19.99 set
98167G	5-7/8" - 6-3/8"	133mm-146mm	19.99 set

Red

98162R	2-3/4" - 3-1/4"	70mm-83mm	19.99 set
98163R	3-3/8" - 3-7/8"	86mm-99mm	19.99 set
98164R	4" - 4-1/2"	102mm-115mm	19.99 set
98165R	4-5/8" - 5-1/8"	117mm-130mm	19.99 set
98166R	5-1/4" - 5-3/4"	133mm-146mm	19.99 set
98167R	5-7/8" - 6-3/8"	133mm-146mm	19.99 set

Performance Suspension

ridetech

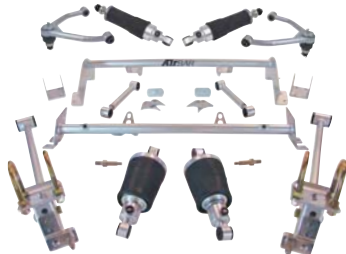

MB2347

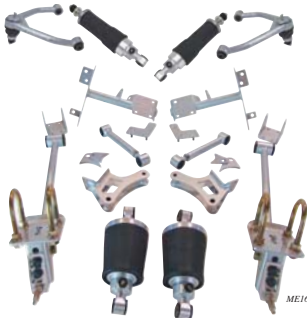

ME1656



1968-74 B & E-Body Ride Tech® Level 2 Suspension System

Enjoy suspension adjustability with Ride Tech's full suspension system for 1968-70 B-body and 1970-74 E-body models. In a matter of seconds, you can adjust your ride height and spring rate for maximum traction at the drag strip, or tighten up the suspension to handle a road course. For the front end of your Mopar, you get a pair of Strong-Arm tubular upper control arms and adjustable ShockWave air springs, which work in conjunction with the original torsion bar suspension. The rear suspension includes a pair of adjustable ShockWave air springs and a bolt-in 4-link AirBar system that replaces the factory leaf springs and upgrades the suspension geometry for better handling and launching. And to manage your Ride Tech suspension, a 5 gallon dual compressor Ride-Pro™ compressor system provides 4 way digital control, and allows 3 system air pressure presets to provide accurate adjustments with the touch of a button. Made in USA.

Note: *Shipped overweight. **Shipped track freight. No further discounts apply.

1968-70 B-Body
MB2347** Level 2 Set w/Single Adjustable Shockwaves..... 5104.99 set
1970-74 E-Body
ME1656** Level 2 Set w/Single Adjustable Shockwaves..... 5104.99 set



H80110



1966-74 Hotchkis Total Vehicle System (TVS)

Hotchkis' TVS (Total Vehicle System) kits contain engineered and tuned components that work together as a complete suspension system to maximize your vehicle's handling. Avoid the poor ride quality and disappointing handling that often results from combining a mixture of components from multiple manufacturers. These packages have passed rigorous in-house testing procedures. Designed for the driving enthusiast who demands the ultimate in vehicle handling and performance without sacrificing ride comfort! Balanced handling is achieved using geometry corrected upper control arms, adjustable strut rods, adjustable steering rods, front and rear sway bars, and geometry corrected rear leaf springs. The TVS works with your stock K-member. Made in USA.

Note: Shipped track freight. No further discounts apply.

H80113	1967-72	A-Body w/big ball joints.....	1999.99 kit
H80114	1973-76	A-Body.....	2023.99 kit
H80110	1966-69	B-Body.....	2617.99 kit
H80111	1970-74	Challenger.....	2840.99 kit
H80112	1970-74	Cuda.....	2840.99 kit



H4010



1966-76 Hotchkis Weld-In Sub-Frame Connectors

One of the most important additions to your high performance classic Mopar is installing sub-frame connectors. Hotchkis Performance class frame connectors bridge the gap between the front frame rails and the rear frame rails, thus keeping the chassis rigid and reducing flex to improve performance. Fabricated from 1-1/2" x 2-1/2" rectangular steel, MIG welded and powder coated gloss black. Installation does not require modifications or cutting of the floor pan; but does require welding. These sub-frame connectors are an absolute must on a high performance 340, Hemi, or 440 equipped Mopar. Made in USA.

Note: No further discounts apply.

H4014	1967-76	A-Body, 108" wheelbase.....	279.99 pr
H4015	1971-76	A-Body, 111" wheelbase.....	279.99 pr
H4010	1966-70	B-Body.....	339.99 pr
H4011L	1970-74	Challenger.....	359.99 pr
H4011S	1970-74	Cuda.....	359.99 pr

Hotchkis Super Grease

This silicone based grease will reduce squeaking and keep your polyurethane bushings quiet. This waterproof, high temperature, high pressure formula is ideal for use in grease guns.

Note: No further discounts apply.

H3101	14 oz tube.....	27.99 ea
-------	-----------------	----------



STEERING, SUSPENSION, REAR END & BRAKES

AlterKtion Front Suspensions Handles the Competition!



Unrivaled Performance on Any Road Surface

From bumpy, pothole-lined streets to winding mountain roads and silky-smooth racetracks, Reilly Motorsports has designed the AlterKtion front suspension



Featured on Classic Industries' "Twisted" Duster

to perform in all conditions. The highest quality manufacturing and design goes into every suspension system. The result is a weight-saving performance package that bolts in without welding, providing adjustability and even allowing clearance for engine, oil pan, exhaust, and steering columns. Made in the USA.



MD47232



Tubular Control Arms

AlterKtion tubular control arms use standard B-Body screw-in upper ball joints. The lower control arm features a B7 steel through-shaft - an AlterKtion exclusive.

Greaseable Bushings

Lower control arm/sway bar bushings are greaseable for longer life and less noise.

Motor Mounts

Engine frame mounts are installed in the proper position for your engine. The standard polyurethane spool mounts are proven to 600hp.

Power Rack & Pinion Steering

Save weight and increase steering precision. AlterKtion's silver powder coated rack and pinion features a 2.75 turns lock-to-lock with 6" total travel.

Coil-Over Shocks

Double-adjustable Viking coil-overs.

Maximum Adjustability

Custom-tune your suspension with adjustable upper control arms and tie rods.

Powder Coated Durability

All suspension components are powder coated gloss black for corrosion resistance.

1962-76 AlterKtion Sets with Double-Adjustable Viking Coil-Overs

Reilly Motorsports' AlterKtion systems with double-adjustable Viking coil-overs. Adjust compression and rebound independently. Includes shock adjustment wrench and detailed instructions.

Important: 1962-72 A-bodies only require removal of the lower hump stop bracket, while all other cars require the upper and lower hump stop brackets to be removed for this installation and two 3/8" holes will have to be drilled. AlterKtion uses Mustang II style spindles, not Mopar spindles.

Note: Special order, must be prepaid. Shipped oversize. No further discounts apply.

A-Body

MD47216	1967-76	273/318/R3	4994.99 set
MD47217	1967-76	340/360	4994.99 set
MD47218	1967-72	383/440	4994.99 set
MD47219	1967-76	426-style Hemi	4994.99 set
MD47220	1967-76	5.7L/6.1L Hemi	4994.99 set

B-Body

MD47231	1966-72	273-318	4994.99 set
MD47232	1966-72	340/360	4994.99 set
MD47233	1966-72	383/440	4994.99 set
MD47234	1966-72	426-style Hemi	4994.99 set
MD47235	1966-72	5.7L/6.1L Hemi	4994.99 set

E-Body

MD47231	1970-74	273-318	4994.99 set
MD47232	1970-74	340/360	4994.99 set
MD47233	1970-74	383/440	4994.99 set
MD47234	1970-74	426-style Hemi	4994.99 set
MD47235	1970-74	5.7L/6.1L Hemi	4994.99 set

Dig Your Claws Into Pavement with Street-Lynx Suspension



Improves Rear End Geometry, Traction & Handling!

Get rid of under-performing leaf springs with the Street-Lynx triangulated four-bar system for your Mopar! This system drastically improves suspension geometry, traction and handling for any road surface. Street-Lynx separates the axle



MD47259

locating system from the spring and lighter components provide excellent ride quality and wheel control. The system mounts the coil-overs ahead of the axle to eliminate the wheel hop associated with four-bar systems and still allows a stock fuel tank to mount correctly. A crossbar welds between the factory frame rails with no cutting and lower links bolt into the stock leaf spring locations with adjustable mounts. Made in the USA.

Note: Axle housing not included.



Weld-In Cross Member

Provides mounting points for suspension locating with no chassis cutting.

Lower Link Brackets

Mount directly into the forward leaf spring mounting pocket. No modification necessary.

Powder Coated Durability

All suspension components are powder coated gloss black for corrosion resistance.

Four-Bar Suspension

Triangulated four-bar system locates the axle better than stock leaf springs.

Coil-Over Shocks

Mounted ahead of the axle to eliminate wheel hop, keeping your rear end planted.

1962-76 Street-Lynx Sets w/Double-Adjustable Viking Coil-Overs

Reilly Motorsports' Street-Lynx rear suspension sets with double-adjustable Viking coil-overs make leaf springs a technology of the past. Components are powder coated gloss black and include springs with recommended rating, shock adjusting wrench, and detailed instructions.

Important: For A-Body models, choose stock location hangers or inboard weld-in boxes. If Dana axle is used in A-Body, rear axle tailpipes will not fit over the axle.

Note: Axle housing not included. Special order, must be prepaid. Shipped oversize.

Discounted sets. No further discounts apply.

A-Body

MD47243	1962-66	1994.99 set
MD47244	1967-76	1994.99 set

B-Body

MD47251	1966-67	1994.99 set
MD47252	1968-70	1994.99 set
MD47253	1971-72	1994.99 set
MD47254	1973-74	1994.99 set

E-Body

MD47260	1970-74	1994.99 set
---------	---------	-------------



MD47262

1962-76 Wilwood Front Brake Kits for AlterKtion Front Suspensions

These Wilwood front brake sets are designed for 1962-76 Mopar A, B and E-Body models with the AlterKtion front suspension to provide sufficient wheel and tire clearance and track width. All sets include drilled and slotted rotors with your choice of black or red calipers.

Important: For Mustang II style spindles used with AlterKtion Suspension systems only. Will not work with stock Mopar spindles. Check wheel clearance diagram in installation instructions before purchase at www.wilwood.com.

Note: Shipped oversize. No further discounts apply.

MD47262	1962-76	black powder coated calipers	899.99 kit
MD47263	1962-76	red powder coated calipers	999.99 kit

Forged Dynalite Pro Series

MD47264	1962-76	black powder coated calipers	939.99 kit
MD47265	1962-76	red powder coated calipers	1049.99 kit
MD47266	1962-76	black powder coated calipers	1899.99 kit
MD47267	1962-76	red powder coated calipers	2069.99 kit

STEERING, SUSPENSION, REAR END & BRAKES

Shock Absorbers



1960-74 Front Shocks

51500

Replacement front shocks for A, B and E-Body models. These shocks are built using factory specifications and are available in two types: standard duty for non-performance and normal load driving, and heavy duty for high performance vehicles or vehicles that haul heavy loads.

Standard Front Shocks

51500	1960-73	A-Body	76.99 ea
51500	1962-72	B-Body	76.99 ea
51500	1970-74	E-Body	76.99 ea

Heavy Duty Front Shocks

51275	1960-73	A-Body	115.99 ea
51275	1962-72	B-Body	115.99 ea
51275	1970-74	E-Body	115.99 ea



1960-74 Rear Shocks

51368

Rear shocks for A, B and E-Body models. These shocks are built using factory specifications and are available in two types: standard duty for non-performance and normal load driving, and heavy duty for high performance vehicles or vehicles that haul heavy loads.

Standard Rear Shocks

A-Body			
51294	1960-62	Valiant	76.99 ea
51368	1963-73	all	76.99 ea

Plymouth B-Body			
51468	1962-72	all	76.99 ea

Dodge B-Body			
51408	1962-65	all	76.99 ea
51468	1966-72	Charger	76.99 ea
51408	1969-72	Charger	76.99 ea

E-Body			
51468	1970-74	all	76.99 ea

Heavy Duty Rear Shocks

A-Body			
51271	1960-62	Valiant	115.99 ea
50637	1963-73	all	115.99 ea

B-Body			
51273	1962-72	Plymouth	115.99 ea
51273	1962-68	Dodge	115.99 ea
51277	1969-72	Dodge	115.99 ea

E-Body			
51273	1970-74	all	115.99 ea

New!



1962-74 Rear Lower Shock Washers

Reproduction rear lower shock washers for 1962-74 A/B/E models. Washers have the correct concave shape and include the flat flange around the edge. Sold as a set of 4.

MP500403	1962-74 A/B/E Body	11.99 set
----------	--------------------	-----------

1962-76 Rear Shock Absorber Grommet



Made in USA

Quality shock absorber grommet used on most Dodge and Plymouth models, 1-1/4" bottom OD, 3/4" ID, 1" tall, 8 Required per car. Made in USA.

MD2197	1962-76	all models	7.99 ea
--------	---------	------------	---------



1962-76 KYB Gas-a-Just Shocks

KYB's Gas-a-Just shocks are designed to deliver maximum driving control and performance. Gas-a-Just's higher gas pressure keeps tires glued to the road while its high strength, monotube configuration provides extra-rugged durability and fade-free performance.

Front			
KG4509	1963-76	A-Body	49.99 ea
KG4510	1962-72	B-Body	34.99 ea
KG4510	1970-74	E-Body	34.99 ea
Rear			
KG5511	1963-76	A-Body	49.99 ea
KG5512	1962-72	B-Body	49.99 ea
KG5512	1970-74	E-Body	49.99 ea



MD48501



MD48502

1962-76 QA1 Stoker Star Shocks

QA1 offers Stoker Star Shocks in your choice of fixed, single-adjustable and double-adjustable configuration. The fixed, non-adjustable version is a rebuildable and revalveable shock for the budget-conscious owner. The single adjustable-shock lets you simultaneously change the compression and rebound with one knob, choosing 18 valving options. The double adjustable shock offers two knobs to adjust compression and rebound separately, resulting in 324 valving options to fine-tune your ride for any type of driving. All shocks have polyurethane bushings and are sold individually. Two required per axle.

Important: Some disassembly or modification may be necessary to mount these shocks.
Note: No further discounts apply.



Front Shocks

Non-Adjustable Shocks			
MD48501	1960-76	A-Body	109.99 ea
MD48501	1962-72	B-Body	109.99 ea
MD48501	1970-74	E-Body	109.99 ea

Single Adjustable Shocks			
MD48502	1960-76	A-Body	154.99 ea
MD48502	1962-72	B-Body	154.99 ea
MD48502	1970-74	E-Body	154.99 ea

Double Adjustable Shocks			
MD48503	1960-76	A-Body	229.99 ea
MD48503	1962-72	B-Body	229.99 ea
MD48503	1970-74	E-Body	229.99 ea

Rear Shocks

Non-Adjustable Shocks			
MD48901	1960-76	A-Body	109.99 ea
MD48901	1962-72	B-Body	109.99 ea
MD48901	1970-74	E-Body	109.99 ea

Single Adjustable Shocks			
MD48902	1960-76	A-Body	154.99 ea
MD48902	1962-72	B-Body	154.99 ea
MD48902	1970-74	E-Body	154.99 ea

Double Adjustable Shocks			
MD48903	1960-76	A-Body	239.99 ea
MD48903	1962-72	B-Body	239.99 ea
MD48903	1970-74	E-Body	239.99 ea

New!



ridetech



22069856 22099868 22169856 22199867

Features:

- Large-piston mono-tube design for superior oil control — increases ride quality
- 1/2" hardened shaft is precision ground and straightened to a .001" tolerance
- Billet end cap with integrated teflon debris wiper prevents seal damage
- Oversized rod guide improves piston rod stability
- Wear-resistant cathode anodized mono-tube bore
- Composite gas separator cap ensures proper nitrogen/oil separation

1962-76 Ridetech Q Series Monotube Shocks

These smooth body aluminum Q-Series shock absorbers with their robust monotube design are a durable, direct replacement performance upgrade for nearly any Mopar build. Backed by a 1,000,001-mile Ride-Tech warranty.

Note: No further discounts apply.



RQ Shocks - Ride Quality

RQ Series shocks have been designed and tuned for a balance optimum ride quality and performance handling. RQ is the install-it-and-forget-it solution for enthusiasts looking to get more out of their muscle car! Sold each. Two required.

Front Shocks			
22069856	1963-76	A-Body	124.99 ea
22069856	1962-72	B-Body	124.99 ea
22049858	1973-76	B-Body	124.99 ea
22069856	1970-74	E-Body	124.99 ea

Rear Shocks			
22099868	1963-76	A-Body	124.99 ea
22099867	1962-76	B-Body	124.99 ea
22099867	1970-74	E-Body	124.99 ea

HQ Shocks - Handling Quality

HQ Series shocks offer 20 settings of rebound adjustment for drivers to tune ride quality and handling quality to their specific taste. Switch between cruising in comfort or stiffen your suspension for spirited driving. Sold each. Two required.

Front Shocks			
22169856	1963-76	A-Body	174.99 ea
22169856	1962-72	B-Body	174.99 ea
22149858	1973-76	B-Body	174.99 ea
22169856	1970-74	E-Body	174.99 ea

Rear Shocks 2 required			
22199867	1963-76	A-Body	174.99 ea
22199867	1962-76	B-Body	174.99 ea
22199867	1970-74	E-Body	174.99 ea

Rear Suspension Components



1964-74 Rear Leaf Springs

These rear leaf springs are designed for an exact, direct replacement of the originals. These springs will fit the body model regardless of engine size. Springs include end bushings installed.

Note: Performance rear leaf springs were standard on Hemi and 440 equipped vehicles.
Shipped double oversize. No further discounts apply.



Standard Duty Springs

A-Body			
MR3105	1964-66	Dart, 5 leaf	449.99 pr
MR3105	1964-66	Barracuda, 5 leaf	449.99 pr
MR3106	1964-66	Valiant, 5 leaf	449.99 pr
MR3107	1967-69	all except Barracuda, 5 leaf	449.99 pr
MR3108	1967-69	Barracuda, 5 leaf	449.99 pr
MR3109	1970-72	all without 340, 5 leaf	449.99 pr
MR3111	1973-74	all, without 340 or 360, 5 leaf	449.99 pr
B-Body			
MR3113	1965	all, 6 leaf	449.99 pr
MR3114	1966-67	all, 5 leaf	449.99 pr
MR3115	1968-72	all, except Road Runner & Super Bee, 5 leaf	449.99 pr
MR3116	1968-72	Road Runner and Super Bee, 5 leaf	449.99 pr
MR3117	1973-74	Road Runner, 5 leaf	449.99 pr
E-Body			
MR3118	1970-74	all, except 340, 383, Hemi and 440, 5 leaf	449.99 pr

Heavy Duty Springs

A-Body			
MR3119	1964-66	Dart, 6 leaf	449.99 pr
MR3119	1964-66	Barracuda, 6 leaf	449.99 pr
MR3119	1964-66	Valiant, 6 leaf	449.99 pr
MR3120	1967	all except Barracuda, 6 leaf	449.99 pr
MR3122	1967-69	Barracuda, 6 leaf	449.99 pr
MR3123	1968-69	all except Barracuda, 6 leaf	449.99 pr
MR3110	1970-72	all, with 340, 6 leaf	449.99 pr
MR3112	1973-74	all, with 340, 360, 6 leaf	449.99 pr
B-Body			
MR3121	1965	all, 6 leaf	449.99 pr
MR3116	1968-72	all, 5 leaf	449.99 pr
MR3124	1973-74	all, 6 leaf	449.99 pr

Performance Springs - Hemi and 440

B-Body			
MR3125	1965	all, 6 leaf LH, 7 leaf RH	449.99 pr
MR3126	1966-73	all, 6 leaf LH, 7 leaf RH	449.99 pr
MR3127	1974	all, 6 leaf	449.99 pr
E-Body			
MR3128	1970-74	all except Hemi and 440, 5 leaf	449.99 pr
MR3129	1970-74	all, Hemi and 440, 6 leaf	449.99 pr



1966-76 Geometry Correcting Sport Leaf Springs

Hotchkis Springs lower your classic Mopar 1" and improves handling by reducing roll steer. Complete spring set includes lightweight springs, CNC bent relocation brackets, polyurethane and rubber bushings and are painted in a gloss black finish.

Note: Shipped triple oversize. No further discounts apply.



A-Body			
H24385	1967-76	3 leaf, 130 lb./In. spring rate	399.99 kit
B-Body			
H24366	1966-72	3 leaf, 160 lb./In. spring rate	599.99 kit
E-Body			
H24367	1970-74	3 leaf, 160 lb./In. spring rate	599.99 kit



56105G

1973-76 Polyurethane Leaf Spring Pad Set

Upgrade your old rubber leaf spring pads with these polyurethane leaf spring pads for better durability than OE pads. Made in USA.

56105G	1973-76	black	75.99 set
56105R	1973-76	red	75.99 set



1967-74 Leaf Spring Rebuild Sets

These reproduction leaf spring rebuild sets include the metal straps with rubber insulators, plastic interliners, and galvanized steel interliners.

Note: *Except 440, 440-6, Hemi			
Small Block and Big Block			
MN7007*	1968-74	A, B, E-Body	69.99 set
440, 440-6, Hemi			
MN7008	1967-72	B-Body	109.99 set
MN7009	1970-71	E-Body	89.99 set



1968-74 Leaf Spring Plastic Interliners

Reproduction leaf spring plastic interliners for A/B/E-Body models. These are the same grade plastic as original and include the two dimples for locking into the leaf springs. Each set includes 6 interliners; enough for one spring. Two sets required per vehicle.

Note: Some vehicles may take less than six per side.
MN7010 1968-74 A/B/E-Body..... 17.99 set



1961-76 Leaf Spring Traction Device

The "Assassin" leaf spring traction device is designed to handle the needs of high horsepower cars. Features chrome moly tubing, teflon lined rod ends, and heavy duty gusset spring brackets with a built-in tie down. The "Assassin" offers more adjustments for better traction control than any other leaf spring device. This device will fit both mono and multi-leaf springs and the leaf spring does not need to be removed for installation. Approved by NHTA and MCMa. Made in USA.

SD5003	1961-76	A-Body	339.99 set
SD5004	1962-76	B-Body	339.99 set
SD5004	1970-74	E-Body	339.99 set

Rear Suspension Components

New!



MP500401 MP500402

Front Eye Leaf Spring Bushings

Reproduction front eye leaf spring bushings for B/E-body Mopar models. These are made by the original manufacturer who made these for Mopar. They look and install just like the originals.

MP500401 B/E-Body with 440/Hemi... 27.99 ea
MP500402 B/E-Body except 440/Hemi 27.99 ea



MN41015G



MN41016R

Made in USA

1960-76 Heavy Duty Shackle & Bushing Sets

Polyurethane shackle and bushing sets for 1960-76 Mopar models. Polyurethane bushings withstand wear and tear far better than rubber, and keep your suspension tight. Includes premium quality polyurethane bushings, grease for lubrication during installation, and related heavy duty shackles where applicable. Available in black or red. Please specify color when ordering (G-Black or R-Red). Made in USA.

Important: A - Main Eye Bushing Diameter. B - Main Eye Bolt Diameter. C - Shackle Bushing Diameter.

Note: No further discounts apply.

Shackle & Bushing Sets

A-Body Models

Part#	Year	A	B	C	Price
MN41015	1960-76	2"	5/8"	7/8"	104.99 set
MN41013	1960-76	1-1/2"	5/8"	7/8"	99.99 set
MN41014	1960-76	1-1/2"	1/2"	7/8"	109.99 set
MN41012	1960-76	1-3/8"	7/16"	7/8"	99.99 set

B-Body Models

Part#	Year	A	B	C	Price
MN41010	1960-72	2"	5/8"	1"	104.99 set
MN41011	1960-72	1-1/2"	5/8"	1"	99.99 set

E-Body Models

Part#	Year	A	B	C	Price
MN41010	1970-74	2"	5/8"	1"	104.99 set
MN41011	1970-74	1-1/2"	5/8"	1"	99.99 set

Bushings Only Sets

A-Body Models

Part#	Year	A	B	C	Price
MN41016	1960-76	2"	5/8"	7/8"	41.99 set
MN41017	1960-76	1-1/2"	5/8"	7/8"	39.99 set
MN41004	1960-76	1-1/2"	1/2"	7/8"	49.99 set
MN41003	1960-76	1-3/8"	7/16"	7/8"	34.99 set

B-Body Models

Part#	Year	A	B	C	Price
MN41001	1960-72	2"	5/8"	1"	41.99 set
MN41002	1960-72	1-1/2"	5/8"	7/8"	39.99 set
MN41009	1973-76	oval	5/8"	1"	59.99 set

E-Body Models

Part#	Year	A	B	C	Price
MN41001	1970-74	2"	5/8"	1"	41.99 set
MN41002	1970-74	1-1/2"	5/8"	1"	39.99 set



MN8040R



MN8040G

Made in USA

1960-76 Heavy Duty Prothane Shackle Sets

Polyurethane shackle and bushing sets for 1960-76 Mopar models. Polyurethane bushings withstand wear and tear far better than rubber, and keep your suspension tight. Includes premium quality polyurethane bushings, grease for lubrication during installation, and related heavy duty shackles where applicable. Available in black or red. Please specify color when ordering (G-Black or R-Red). Made in USA.

Note: No further discounts apply.

A-Body Models

MN8050	1960-76	w/7/8" bushings	84.99 set
MN8040	1960-76	w/1" bushings	84.99 set

B-Body Models

MN8040	1960-76	w/1" bushings	84.99 set
--------	---------	---------------	-----------

E-Body Models

MN8040	1960-76	w/1" bushings	84.99 set
--------	---------	---------------	-----------

Made in USA

1960-76 Prothane Shackle Bushing Sets

Polyurethane shackle and bushing sets for 1960-76 Mopar models. Polyurethane bushings withstand wear and tear far better than rubber, and keep your suspension tight. Includes premium quality polyurethane bushings, grease for lubrication during installation. Available in black or red. Please specify color when ordering (G-Black or R-Red). Made in USA.

Note: No further discounts apply.

A-Body Models

MN8020	1960-72	w/7/8" bushings	14.99 set
MN8020	1960-76	w/1" bushings	14.99 set

B-Body Models

MN8020	1960-72	w/1" bushings	14.99 set
MN8030	1973-76	w/1" bushings	19.99 set

E-Body Models

MN8020	1970-74	w/1" bushings	14.99 set
--------	---------	---------------	-----------

Standard Shackles

MN8010	1960-76	w/7/8" bushings	14.99 set
MN8020	1960-76	w/1" bushings	14.99 set

B-Body Models

MN8020	1960-72	w/1" bushings	14.99 set
MN8030	1973-76	w/1" bushings	19.99 set

E-Body Models

MN8020	1970-74	w/1" bushings	14.99 set
--------	---------	---------------	-----------



MM41018G

Made in USA

Spring Eye and Heavy Duty Super Stock Conversion Shackle Set

This set is designed to upgrade A and B-Body models without super stock springs. Includes polyurethane bushings, heavy duty shackles, hardware, and grease. Available in black or red. Please specify color when ordering (G-Black or R-Red). Made in USA.

Note: For models without Super Stock springs. No further discounts apply.

MN41018	1960-67	A-Body	104.99 set
MN41018	1960-62	B-Body	104.99 set



MM48060R

Made in USA

Heavy Duty Conversion Shackle Set to Install Super Stock Springs

This heavy duty shackle upgrade set is designed for the A-Body models with super stock springs. Includes polyurethane bushings, heavy duty shackles, hardware and grease. Available in black or red. Please specify color when ordering (G-Black or R-Red). Made in USA.

Note: For models with Super Stock springs. No further discounts apply.

MN48060	1960-67	A-Body	84.99 set
---------	---------	--------	-----------



MN8030G

Made in USA

1960-76 Prothane Shackle Bushing Sets

Polyurethane shackle and bushing sets for 1960-76 Mopar models. Polyurethane bushings withstand wear and tear far better than rubber, and keep your suspension tight. Includes premium quality polyurethane bushings, grease for lubrication during installation. Available in black or red. Please specify color when ordering (G-Black or R-Red). Made in USA.

Note: No further discounts apply.

A-Body Models

MN8010	1960-76	w/7/8" bushings	14.99 set
MN8020	1960-76	w/1" bushings	14.99 set

B-Body Models

MN8020	1960-72	w/1" bushings	14.99 set
MN8030	1973-76	w/1" bushings	19.99 set

E-Body Models

MN8020	1970-74	w/1" bushings	14.99 set
--------	---------	---------------	-----------



MR3000

1960-76 Rear Spring Shackle Bushing Kit

Quality rubber bushings for the rear leaf spring shackles. These should be replaced when changing the rear leaf spring or when you see that they are cracked or pushed out. Each kit includes 8 bushings.

Note: No further discounts apply.

MR3000	1960-76	A-Body	17.99 kit
MR3001	1962-74	B-Body	19.99 kit
MR3001	1970-74	E-Body	19.99 kit

STEERING, SUSPENSION, REAR END & BRAKES

Performance Rear Axles



MM875309



1960-74 Moser 8-3/4" Muscle Pak Performance Rear Axle



The Moser Muscle Pak rear end gives you a complete axle assembly to install in your Mopar. The assembly work has been completed by Moser's expert technicians, all you have to do is add gear oil! Leaf spring perches are welded in the stock location. Choose from a brand new 8-3/4" or Dana 60 assembly in a stamped steel housing with all new parts. This is a great upgrade for your driver or fresh restoration. Made in USA.

Note: Shipped truck freight. Special order, must be pre-paid. No further discounts apply.

- 30 Spline Bolt-In Axles
- 5 x 4-1/2" Bolt Pattern
- Axle Bearings
- Stock Wheel Studs
- Retainer Plates
- Nodular Iron 489 Case
- Auburn Limited Slip
- Ring & Pinion
- 1350 Series Cast Pinion Yoke
- Flat Pinion Snubber
- Differential with Timken bearings
- 11" Drum Brakes
- E-Brake Cables & Brake Clamps
- Choice of gear ratio (3.55, 3.73, 3.91 or 4.10)



MD600309



1960-74 Moser Dana 60 Muscle Pak Performance Rear Axle



The Moser Dana 60 Muscle Pak gives you a complete axle assembly to install in your Mopar. The assembly work has been completed by Moser's expert technicians, all you have to do is add gear oil! Leaf spring perches are welded in the stock location. You get a brand new Moser Dana 60 stamped steel housing with all new parts. This is a great upgrade to your driver or fresh restoration. Made in USA.

Note: Shipped truck freight. Special order, must be pre-paid. No further discounts apply.

- 35 Spline Bolt-In Axles
- 5 x 4-1/2" Bolt Pattern
- Axle Bearings
- Stock Wheel Studs
- Retainer Plates
- Trac-Loc Limited Slip
- Ring & Pinion
- 1350 Series Cast Pinion Yoke
- Chrome Cover
- Flat Pinion Snubber
- Differential with Timken bearings
- 11" Drum Brakes
- E-Brake Cables & Brake Clamps
- Choice of gear ratio (3.55, 3.73, 3.91 or 4.10)



MN7013



MN7014



MN7016

1963-76 Drive Shaft Safety Loops

These NHRA-legal drive shaft safety loops are designed to fit 1962-76 A.B., and E-Body models. These one-piece loops are fixture-welded with an oversized ring cut from DOM tubing for maximum clearance. Powder coated black for durable surface protection. Includes grade 8 hardware and instructions. Made in USA.

MN7013	1963-66	A-Body	79.99 ea
MN7014	1967-76	A-Body	79.99 ea
MN7016	1966-70	B-Body	79.99 ea
MN7017	1971-74	B-Body	79.99 ea
MN7018	1970-74	E-Body	79.99 ea



MM3108

1960-74 Adjustable Pinion Snubbers

If you are using the stock leaf spring rear suspension with a high horsepower to your engine, then you need to add an adjustable pinion snubber. These help control axle windup by adjusting the height to the floor pan. Without a pinion snubber your axle will rotate upward, causing loss of traction and possible driveline damage. These mount on the center front of the rear axle housing.

MM3108	8-3/4" axles	84.99 ea
MM3109	Dana 60 axles	84.99 ea

8-3/4" Muscle Pak Rear Axle

A-Body	Year	Ratio	Price
MM875300	1963-74	3.55 gear ratio	3529.99 ea
MM875301	1963-74	3.73 gear ratio	3529.99 ea
MM875302	1963-74	3.91 gear ratio	3529.99 ea
MM875303	1963-74	4.10 gear ratio	3529.99 ea

B-Body	Year	Ratio	Price
MM875304	1960-67	3.55 gear ratio	3529.99 ea
MM875305	1960-67	3.73 gear ratio	3529.99 ea
MM875306	1960-67	3.91 gear ratio	3529.99 ea
MM875307	1960-67	4.10 gear ratio	3529.99 ea
MM875308	1968-70	3.55 gear ratio	3529.99 ea
MM875309	1968-70	3.73 gear ratio	3529.99 ea
MM875310	1968-70	3.91 gear ratio	3529.99 ea
MM875311	1968-70	4.10 gear ratio	3529.99 ea
MM875312	1971-74	3.55 gear ratio	3529.99 ea
MM875313	1971-74	3.73 gear ratio	3529.99 ea
MM875314	1971-74	3.91 gear ratio	3529.99 ea
MM875315	1971-74	4.10 gear ratio	3529.99 ea

E-Body	Year	Ratio	Price
MM875316	1970-74	3.55 gear ratio	3529.99 ea
MM875317	1970-74	3.73 gear ratio	3529.99 ea
MM875318	1970-74	3.91 gear ratio	3529.99 ea
MM875319	1970-74	4.10 gear ratio	3529.99 ea

Dana 60 Muscle Pak Rear Axle

A-Body	Year	Ratio	Price
MD600300	1963-74	3.55 gear ratio	3209.99 ea
MD600301	1963-74	3.73 gear ratio	3209.99 ea
MD600302	1963-74	3.91 gear ratio	3209.99 ea
MD600303	1963-74	4.10 gear ratio	3209.99 ea

B-Body	Year	Ratio	Price
MD600304	1960-67	3.55 gear ratio	3209.99 ea
MD600305	1960-67	3.73 gear ratio	3209.99 ea
MD600306	1960-67	3.91 gear ratio	3209.99 ea
MD600307	1960-67	4.10 gear ratio	3209.99 ea
MD600308	1968-70	3.55 gear ratio	3239.99 ea
MD600309	1968-70	3.73 gear ratio	3209.99 ea
MD600310	1968-70	3.91 gear ratio	3209.99 ea
MD600311	1968-70	4.10 gear ratio	3209.99 ea
MD600312	1971-74	3.55 gear ratio	3209.99 ea
MD600313	1971-74	3.73 gear ratio	3209.99 ea
MD600314	1971-74	3.91 gear ratio	3209.99 ea
MD600315	1971-74	4.10 gear ratio	3209.99 ea

E-Body	Year	Ratio	Price
MD600316	1970-74	3.55 gear ratio	3609.99 ea
MD600317	1970-74	3.73 gear ratio	3209.99 ea
MD600318	1970-74	3.91 gear ratio	3209.99 ea
MD600319	1970-74	4.10 gear ratio	3209.99 ea

Ring & Pinions

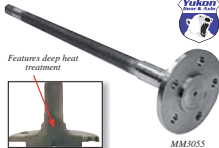

Features deep heat treatment



MM3055

1965-74 Rear Axle Shafts for 8-3/4" Rear Axle

High strength axle shafts for Mopar muscle cars equipped with an 8-3/4" rear end. Yukon axles are made from 1541H alloy and are deeply heat-treated to be 20-25% stronger than OEM 1040/1050 steel axles. These axles also feature rolled splines, which provides a 30% strength increase over cut-splines. Must use with Yukon bearings, sold separately.

Note: For A-body models converted to 5 x 4.5" wheel bolt pattern and 10" x 2.5" or 11" x 2.5" drum brakes.

A-Body

MM3042* 1965-72 5 x 4.5" bolt pattern 139.99 ea

E-Body

MM3055 1970-74 all..... 139.99 ea



1965-74 8-3/4" Rear Axle "Green" Bearings

Prevent costly damage by replacing rear axle bearings before they seize! "Green" sealed ball bearing for use on passenger car 8-3/4" rear end assemblies. Includes gasket and retainer. Two required per vehicle. MM3063 1965-74 "green" bearing..... 69.99 kit



1960-76 Axle Bearing Retainer Gasket

Replacement for the original rear axle bearing retainer gasket used on most 1960-76 A, B and E-body Dodge and Plymouth models. For use with 8-3/4", 9-1/4" and 9-3/4" rear ends. Made in USA.

MM1512 1960-76 all..... 4.99 ea



8-1/4" & 9-1/4" Pinion Crush Sleeves

Original style crush sleeves for setting up rear axle. Crush sleeves cannot be reused if you are changing a ring and pinion or the front seal. Includes pinion nut, washer and pinion flange nut. These are for the 8-1/4" and 9-1/4" differentials only.

MM3107 17.99 set



MM3060

1969-74 Yukon 8-3/4" Ring and Pinion Sets

High performance Yukon ring and pinion gear set for Chrysler 8-3/4" rear ends with the 1-7/8" pinion stem. Yukon uses the latest designs and manufacturing technologies to provide a strong and quiet running gear. Includes ring and pinion gear.

MM3060 1969-74 3.55 ratio 359.99 set

MM3061 1969-74 3.91 ratio 339.99 set

MM3062 1969-74 4.11 ratio 419.99 set



MM3130

Motive Gear 8-3/4" Ring and Pinion Sets

Motive Gear offers some of the toughest drivetrain components on the market today, with products that can be found in the winner's circle at NHRA, IHRA, and NASCAR events. The superior quality of Motive Gear components is the result of years of racing development, outstanding design, and state-of-the-art manufacturing methods, with gear sets in a wide range of ratios for most applications.

741 Housing

MM3119 10-bolt 741 3.55 ratio 214.99 set

MM3120 10-bolt 741 3.73 ratio 214.99 set

742 Housing

MM3121 9-bolt 742 3.73 ratio 209.99 set

MM3122 9-bolt 742 3.91 ratio 209.99 set

MM3123 9-bolt 742 4.10 ratio 209.99 set

MM3124 9-bolt 742 4.56 ratio 209.99 set

489 Housing

MM3125 9-bolt late 3.55 ratio 224.99 set

MM3126 9-bolt late 3.73 ratio 224.99 set

MM3127 9-bolt late 3.91 ratio 224.99 set

MM3128 9-bolt late 4.10 ratio 224.99 set

MM3129 9-bolt late 4.56 ratio 224.99 set

Motive Gear Dana 60 Ring and Pinion Sets

Motive Gear offers some of the toughest drivetrain components on the market today, with products that can be found in the winner's circle at NHRA, IHRA, and NASCAR events. The superior quality of Motive Gear components is the result of years of racing development, outstanding design, and state-of-the-art manufacturing methods, with gear sets in a wide range of ratios for most applications.

MM3130 gear ratio 3.54 232.99 set

MM3131 gear ratio 3.73 219.99 set

MM3132 gear ratio 4.10 219.99 set

MM3133 gear ratio 4.56 219.99 set



8-1/4" Master Bearing Set

Motive Gear master bearing overhaul set for Chrysler 8.25" rear ends. Included in this set are Timken carrier bearings and races, pinion bearings and races, pinion seal, shims, ring gear bolts, pinion nut, crush sleeve, oil baffles and slingers, thread locking compound, marking compound with brush, and gasket.

MM3100 8-1/4" w/Timken bearings..... 99.99 set



8-3/4" Master Bearing Sets

Yukon master overhaul set for Chrysler 8.75" rear ends. Included in this set are Timken carrier bearings and races, pinion bearings and races, pinion seal, shim kit, ring gear bolts, pinion nut, crush sleeve, oil baffles and slingers, thread locking compound, marking compound with brush, and gasket.

MM3057 1-3/8" pinion stem..... 204.99 set

MM3058 1-3/4" pinion stem..... 254.99 set

MM3059 1-7/8" pinion stem..... 179.99 set



Dana 60 Master Bearing Sets

Motive Gear master bearing overhaul set for Dana 60 rear ends which were installed on certain performance Mopars. Included in this set are Timken carrier bearings and races, pinion bearings and races, pinion seal, shims, ring gear bolts, pinion nut, crush sleeve, oil baffles and slingers, thread locking compound, marking compound with brush, and gasket.

MM3101 Dana 60..... 164.99 set

Rear Axle Components



8-3/4" Ring Gear Fasteners

These Pro-Series ring gear bolt kits from ARP are forged from premium-grade S740 chrome moly steel and heat-treated to a rating of 190,000 psi. This is a set of 12-3/8"-24 LH threaded bolts for the 8-3/4" ring gear. Made in USA.
MM3098 1960-71..... 43.99 set



MM3097

MM3110

8-1/4" and 8-3/4" Ring Gear Fasteners

Ring gear bolts for 1960-71 Mopar 8-1/4" and 8-3/4" differentials. These are factory replacement quality sold individually or in sets of 12 for the entire differential.
MM3097 individual..... 2.99 ea
MM3110 12 pc. replacement..... 32.99 set
MM3099 12 pc. Mopar Performance ... 114.99 set

New!



Bottom view

Shown bolted to a work bench. Bolts and hardware not included with fixture.



8-3/4" Mopar Differential Holding Fixture

Work on your differential third member safely and easily with this lightweight fixture. It can be clamped or bolted to your work bench or simply mounted in a vise, and it fits neatly in your tool chest when the job is finished. This fixture features a gloss powder coat finish and is designed for all 8-3/4" Mopar differential third members.
MD490072 8-3/4" differentials..... 79.99 ea

New!



8-3/4" Differential Side

Carrier Bearing Spanner Wrench

Adjust pinion depth correctly with this spanner wrench. Manufactured from heavy gauge steel, with hard pins and finished in gloss black powder coat, this spanner wrench is designed for 1957-74 Mopar 8-3/4" side bearing adjusters. Made in USA.
MD490073..... 69.99 ea

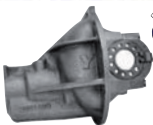

"489" 8-3/4" Drop-Out Housing

Direct replacement "489" case drop-out differential housing for 1969-74 Chrysler 8-3/4" rear end assemblies with an 1-7/8" pinion stem. This modular iron housing improves upon the factory design by correcting weaknesses found in the original, which allows this unit to handle up to 500 horsepower. The housing features the original Chrysler part number casting, extra material on the bearing caps for added strength and reduced deflection, and high strength billet side adjusters. Although this unit is a direct replacement for 1969-74 models, it can also be used to upgrade the weaker 8-3/4" rear ends installed in 1965-69 applications.
MM3056 1969-74 8-3/4" housing 329.99 ea



1960-74 8-3/4" Limited-Slip Differential

Auburn Gear's Pro Series limited-slip differentials outperform standard OEM differentials hands down. They deliver more traction and faster engagement for controlled power transfer and lightning fast reaction to changing load conditions. No matter what your application, the Auburn Gear limited-slip differential is engineered to provide smooth torque-sensing operation with bias ratios.
8-3/4" 10 Bolt
542051 1960-74 10 bolt, 30 spline... 574.99 ea



MM3102



P4452787

Chrome Differential Covers & Bolts

Impress those behind you with a chrome differential cover. These chrome covers are for 8-1/4" or Dana 60 rear-axles and include the gasket and fill plug. Bolts are sold separately. Each bolt set includes enough bolts to mount the differential cover to the axle housing.

Differential Covers

MM3102 8-1/4" rear axle..... 74.99 ea

Differential Bolt Sets

P4452787 8-1/4" rear axle set of 12... 26.99 set

P5249719 Dana 60 rear axle set of 10... 29.99 set



MN7011



MN7012

1961-74 Differential Gaskets

Original quality replacement rear cover gaskets for 8-3/4" or Dana 60 rear axles. New gaskets should be used when removing or replacing rear end cover.

8-3/4" Rear Axle

MN7011 1967-72 A-Body..... 12.99 ea

MN7011 1961-74 B-Body..... 12.99 ea

MN7011 1970-74 E-Body..... 12.99 ea

Dana 60 Rear Axle

MN7012 1966-74 A/B/E-Body..... 12.99 ea

New!



Stainless Steel Rear Cover Bolts

Enhance your GM 10 or 12-bolt rear end with ARP's stainless steel rear cover bolts. Add lustrous contrast to a painted OEM cover, compliment a chrome plated aftermarket version, or add flash to a cast aluminum cover. These precision machined 170,000 psi bolts are much stronger than stock (or even grade 8) hardware and will not rust! Includes twelve 12-point stainless steel flanged bolts and washers.
AR43732..... 21.99 set



MN7000



MN7006

MN7003

Rear Axle Identification Tags

Reproduction rear axle identification tags for 8-3/4" and Dana 60 rear axles. These tags identify the gear ratio correct lubrication to use for the limited slip on the 8-3/4" or Sure-Grip on the Dana 60 axles. Replace damaged or missing tags to enhance the authenticity of your restoration.

8-3/4" Rear Axle

MN7001 long limited slip lube..... 24.99 ea

MN7002 3:23 ratio..... 19.99 ea

MN7004 3.55 ratio..... 19.99 ea

MN7005 3:91 ratio..... 19.99 ea

Dana 60 Rear Axle

MN7000 round sure grip - aluminum... 24.99 ea

MN7003 3:54 ratio..... 19.99 ea

MN7006 4:10 ratio..... 19.99 ea

Rear Axle Components



1968-73 Rear Axle Bumpers

Replacement rear axle bumpers for 1968-73 B and E-Body vehicles. Axle bumpers prevent the axle from slamming against the frame if the suspension is ever bottomed out. Mounting hardware is not included. Sold in pairs.

Dodge B-Body

6 Cyl & 318, 383 Engines	
MN1616 1968-70 all	51.99 pr
440, Hemi Engines	
MN1614 1968-70 all	51.99 pr

Plymouth B-Body

6 Cyl & 318, 383 Engines	
MN1614 1968-70 all	51.99 pr
440, Hemi Engines	
MN1614 1968-70 all	51.99 pr

E-Body

6 Cyl & 318, 383 Engines	
MN1618 1970-73 all	37.99 pr
340, 440, Hemi Engines	
MN1617 1970-71 all	51.99 pr



1962-76 Rear Suspension Bumper

Replacement rear suspension bumper for all 1962-76 Mopar models. Mounts to the frame rail above the rear axle. Must reuse metal mounting bracket. Made in USA.

Note: Will fit all models through 1976, but is only a correct reproduction for 1964-65 models.

MD7052 1962-76 all models	5.99 ea
---------------------------	---------



1970-74 8-3/4" Pinion Snubber

Replacement rear axle pinion snubber for 1970-74 Dodge & Plymouth models. Rubber construction as original with two mounting tabs. Made in USA.

MN1513 1970-74 all	14.99 ea
--------------------	----------



Differential Cover FilterMag

Powerful rare-earth magnets trap and hold wear inducing metal particles smaller than 40-microns down to 1-micron that the filter cannot stop, keeping metal particles from harming your differential and holding FilterMag in place. Reusable, these will reduce maintenance costs by extending the life of your oil. The rear end FilterMag attaches to the inside of the differential cover and will help keep it running its best. Install when replacing the rear end gasket.

Note: Mounts to inside of differential cover.

FD1001 2.0" x 1.25"	24.99 ea
---------------------	----------

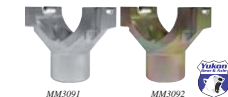

8-3/4" and Dana 60 Pinion Yokes

These differential yokes are manufactured for Mopar 8-3/4" and Dana differentials. Each Mopar performance yoke includes the yoke, retaining straps or U-bolts (as indicated), and mounting hardware. Yulon yokes do not include hardware. Straps and U-bolts are sold separately. Available as cast iron reproductions or performance yokes made with steel.

Note: The 7260 series U-joints have a 2.125" snap ring span with a 1.078" diameter bearing cap. The 7290 Series U-joints have a 2.625" snap ring span with a 1.125" diameter bearing cap. The 1310 series U-joints have a 3.219" snap ring span with a 1.062" diameter bearing cap. The 1350 series U-joints have a 3.625" snap ring span with a 1.125" diameter bearing cap, and the 1350 series U-joints have a 3.625" snap ring span with a 1.188" diameter bearing cap. *Maximum 500 horsepower.

8-3/4" Rear Axles

Cast Iron

Strap Retainers	
MM3089 10-spline 7260 u-joints	199.99 ea
MM3090 10-spline 7290 u-joints	199.99 ea
MM3071 29-spline 7260 u-joints	199.99 ea
MM3064 29-spline 7290 u-joints	199.99 ea

Forged Steel

Strap Retainers	
MM3093 10-spline 1350 u-joints	114.99 ea

Billot Steel

U-Bolt Retainers	
MM3092 10-spline 1350 u-joints	229.99 ea
MM3094 29-spline 1350 u-joints	229.99 ea

Chrome Alloy Billet

U-Bolt Retainers	
MM3081 10-spline 7260 u-joints	244.99 ea
MM3083 10-spline 7290 u-joints	289.99 ea

Heavy Duty Aluminum

Strap Retainers	
MM3091 10-spline 1350 u-joints	149.99 ea

Aluminum Billet

U-Bolt Retainers	
MM3082 10-spline 7260 u-joints	289.99 ea
MM3084 10-spline 7290 u-joints	289.99 ea

Dana 60 Rear Axles

Cast Iron

Strap Retainers	
MM3111 29-spline 7290 u-joints	104.99 ea
MM3112 29-spline 1310 u-joints	114.99 ea
MM3115 29-spline 1350 u-joints	89.99 ea

U-Bolt Retainers	
MM3113 29-spline 1310 u-joints	99.99 ea
MM3114 29-spline 1330 u-joints	139.99 ea
MM3116 29-spline 1350 u-joints	109.99 ea

Billot Steel

Strap Retainers	
MM3117 29-spline 1350 u-joints	219.99 ea

Forged Steel

U-Bolt Retainers	
MM3118 29-spline 1350 u-joints	144.99 ea



U-Joint U-Bolt Service Set

This U-joint U-bolt service set is for models with the Dana 60 rear axle. Each set includes 1 U-bolt, 2 nuts and 2 lock washers, 2 sets required per vehicle.

MM3085 Dana 60 2 required	9.99 set
---------------------------	----------



U-Joint U-Bolt & Strap Kits

These u-joint u-bolt and strap kits are designed for use on stock and Yulon pinion yokes. Made in the USA.

U-Bolts

Includes 2 u-bolts and 4 nuts	
MM3306 1310 u-joint	15.99 kit
MM3307 1350 u-joint	8.99 kit
MM3308 7260 u-joint	7.99 kit
MM3308 7290 u-joint	7.99 kit

Straps

Includes 2 straps and bolts	
MM3309 1310 u-joint	11.99 kit
MM3310 1350 u-joint	8.99 kit
MM3311 7260 u-joint	23.99 kit
MM3095 7290 u-joint	23.99 set

Replacement Driveshaft U-Joints

These are quality replacement U-joints for your Mopar. They feature forged and case hardened alloy steel crosses and heat-treated needle bearings, cold-formed radial bearing cups for 360° lubrication distribution, superior-quality seals, and a grease fitting in the cross body for easy maintenance. Also feature exclusive micro-shield coating to protect against rust and corrosion.



MM3306 2-1/8" yoke 7260 replacement	14.99 ea
MM3087 2-5/8" yoke 7290 replacement	9.99 ea
MM3096 3-5/8" yoke 1350 replacement	39.99 ea

Joe Gibbs Synthetic Gear Oil

Used by Joe Gibbs Racing in every rear end differential and transmission gear box. This fully synthetic, unique SAE 75W-110 gear oil reduces operating temperatures by up to 15° compared to other gear oil brands. Protect your investment with quality lubricants from Joe Gibbs! Available by the quart, as a case of 12 quarts or a 5 gallon pail, your choice.

JG630 quart	19.99 ea
JG631 case of 12 quarts	239.99 ea
JG617 5 gallon pail	379.99 ea

Royal Purple® Max Gear Oil

Max-Gear is an ultra-tough automotive gear oil. It makes gears run smoother, quieter, cooler and longer without overhauls. Max-Gear is recommended for use in front or rear differentials and manual transmissions that specify use of an API GL-5 or GL-4 fluid. All viscosities of Max-Gear are formulated with hypoid friction modifiers necessary for use in clutch or cone type differentials. No additional additives are necessary.

Quarts	
RP1300 75W-90	22.99 ea
RP1301 75W-140	22.99 ea
Cases of 12 Quarts	
RP1230 75W-90	248.99 ea
RP12301 75W-140	248.99 ea

Disc Brake Conversion Sets



W156

"At-The-Wheels" 4-Piston Kelsey Hayes-Style Front Disc Brake Sets

Kelsey Hayes-style disc brake conversion sets feature 43mm 4-piston cast iron calipers for restoration quality disc brake upgrades. Rotors fit behind 14" wheels. A-Body rotors feature a dual bolt pattern. B & E-Body rotors feature a single bolt pattern. Sets bolt to stock drum brake V8 spindle. Corrosion resistant calipers include stainless steel pistons, transfer tubes and bleeders. All kits come with necessary components to make for an easy installation. 11.25" unidirectional rotors and rubber lines. A-Body vehicle applications must have O.E. 10 in. drum brakes. Calipers supplied in unpainted finish.

Note: For A-Body vehicles, original 10" drum brakes only. Shipped overweight.

A-Body Models			
W153	1964-72	standard vented rotors w/OE 10" drums	562.99 set
W153S	1964-72	slotted & plated rotors w/OE 10" drums	969.99 set
B & E-Body Models			
W156	1962-72	standard vented rotors all	696.99 set
W156S	1962-72	slotted & plated rotors all	949.99 set



W1534

- 38mm 3-Piston Tri-Power Calipers
- 13" Big Bite Drilled, Slotted & Plated Rotors
- Fits in Most 17" Wheels
- Braided Stainless Steel Hoses
- Bolts to Stock Drum Brake Spindles
- 5 x 4-1/2" Bolt Pattern
- High Performance Pads



clear anodized

black

red



clear anodized

black

red

polished

- Bolts to Stock Drum Brake Spindle
- Competition 4 Piston Aluminum Calipers
- 45mm Stainless Pistons
- Braided Stainless Steel Hoses
- High Performance Pads
- Mounting Brackets
- Big Bite Cross Drilled Rotors

"At-The-Wheels" 3-Piston Front Disc Brake Conversion Sets

These disc brake conversion sets feature 38mm 3-piston forged aluminum calipers to reduce unsprung weight and better disperse heat. Sets are designed to fit directly onto stock 10" drum spindles. They fit behind most 17" wheels and feature a 5 x 4-1/2" bolt pattern. The set includes two Tri-Power 3-piston calipers, 13" Big Bite drilled, slotted and plated rotors, high performance brake pads and braided stainless steel lines. Big Bite rotors provide maximum stopping power, a cooler operating temperature and eliminate brake fade!

Note: Minimum 17" wheel required for use. For vehicles with original 10" drum brakes only. Shipped overweight.

A-Body Models			
W1534	1964-72	clear	1274.99 set
W1534BK	1964-72	black	1628.99 set
W1534R	1964-72	red	1628.99 set
B & E-Body Models			
W1564	1962-72	clear	1594.99 set
W1564BK	1962-72	black	1694.99 set
W1564R	1962-72	red	1694.99 set

4-Piston Kelsey Hayes-Style Front Disc Brake Sets

Kelsey Hayes-style disc brake conversion sets for 1960-72 Mopar models. Sets include 43mm 4-piston cast iron calipers for originality. Sets are designed to fit directly to 10" drum brake spindles and fit behind most 14" wheels. A-Body rotors feature a dual bolt pattern. B & E-Body rotors feature a single bolt pattern. The dual master cylinder can be used in both manual and power operations and is designed to work properly with disc brake applications. Sets include two Kelsey Hayes-style 4-piston calipers, a dual bowl master cylinder, flex lines, brake pads and your choice of standard vented rotors or slotted and plated rotors.

Note: Cast iron calipers supplied in unpainted finish. For vehicles with original 10" drum brakes only. Shipped overweight.



A153

Manual Disc Brake Conversions

A-Body Models			
A153	1964-72	standard rotor	909.99 set
A153S	1964-72	slotted and plated rotor	959.99 set
B & E-Body Models			
A1544	1960-61	standard rotor	939.99 set
A1544S	1960-61	slotted and plated rotor	989.99 set
A156	1962-72	standard rotor	685.99 set
A156S	1962-72	slotted and plated rotor	735.99 set

Power Disc Brake Conversions

A-Body Models			
A1531	1964-72	standard rotor	1029.99 set
A1531S	1964-72	slotted and plated rotor	1079.99 set
B & E-Body Models			
A1561	1962-72	standard rotor	762.99 set
A1561S	1962-72	slotted and plated rotor	812.99 set

"At-The-Wheels" 4-Piston Competition Series Front Disc Brake Sets

11.25" unidirectional Big Bite Cross Drilled Rotors fit behind most 14" wheels. A-Body rotors feature a dual bolt pattern. B & E-Body rotors feature a 5 x 4-1/2" bolt pattern. All kits come with the necessary components and hardware to make for an easy installation. Includes braided stainless steel hoses. Competition 4-Piston aluminum calipers are available in your choice of color/finish and made in the USA. Big Bite rotors provide maximum stopping power, a cooler operating temperature and eliminate brake fade!

Note: Fits most 14" wheels. For vehicles with original 10" drum brakes only. Shipped overweight.

A-Body Models			
W1537	1964-72	clear	724.99 set
W1537BK	1964-72	black	771.99 set
W1537R	1964-72	red	784.99 set
W1537P	1964-72	polished	814.99 set
B & E-Body Models			
W1567	1962-72	clear	664.99 set
W1567BK	1962-72	black	784.99 set
W1567R	1962-72	red	784.99 set
W1567P	1962-72	polished	814.99 set



Disc Brake Conversion Sets

3-Piston Front Disc Brake Conversion Sets

Disc brake conversion sets for 1962-72 Mopar models. Sets feature 38mm 3-piston forged aluminum calipers to reduce unsprung weight and better disperse heat. Sets are designed to fit directly to 10" drum brake spindles and fit behind most 17" wheels. The dual master cylinder can be used in both manual and power operations and is designed to work properly with disc brake applications. Sets include two Tri-Power 3-piston calipers, a dual bowl master cylinder, braided stainless flex lines, high performance brake pads and your choice of slotted and plated rotors or Big Bite drilled, slotted and plated rotors. All rotors feature 5 x 4-1/2" bolt pattern. Big Bite rotors provide maximum stopping power, a cooler operating temperature and eliminate brake fade!



3-Piston Manual Front Disc Brake Conversions

Get the stopping power you need for the street or track with these disc brake conversion sets. The dual bowl master cylinder can be mounted to the firewall for manual brake applications or to the stock booster for power brake applications. Calipers are available clear anodized, powder coated red or black, or polished. *Note: For vehicles with original 10" drum brakes only. Shipped overweight.*

3-Piston Power Front Disc Brake Conversions

Set includes everything that manual applications include, with the addition of a 7" dual diaphragm booster for A-body models or a 9" booster for B and E-Body models. Calipers are available clear anodized, powder coated red or black, or polished. *Note: Upgrade kits vehicles with manual 10" drum brakes only. Will not fit vehicles with original power brakes. Requires 17" or larger wheels. Shipped overweight.*

Rear Disc Brake Conversion Sets

Rear disc brake conversion sets for 1965-72 Mopar models. Sets replace outdated drum brake components and add superior braking performance. Includes R1 Sport 1-piston forged aluminum calipers with provisions for parking brakes, 11.25" unidirectional rotors with 5 x 4-1/2" bolt pattern, brackets, braided stainless steel brake hoses, pads and hardware. Fits 8-3/4" and Dana60 axles. Calipers are available clear anodized, powder coated red or black, or polished. Big Bite rotors provide maximum stopping power, a cooler operating temperature and eliminate brake fade! *Important: All axles must have 5 x 4-1/2" bolt pattern and 2-1/2" brake spacing for correct installation. Fits 15" wheels and larger. Some vehicles may require new parking brake cables for installation, sold separately. Note: Shipped overweight.*

Slotted and Plated Rotors

A-Body Models	
A1534	1964-72 clear 1356.99 set
A1534BK	1964-72 black 1397.99 set
A1534R	1964-72 red 1397.99 set
A1534P	1964-72 polished 1694.99 set
B & E-Body Models	
A1564	1962-72 clear 1694.99 set
A1564BK	1962-72 black 1794.99 set
A1564R	1962-72 red 1794.99 set
A1564P	1962-72 polished 1844.99 set

Slotted and Plated Rotors

A-Body Models	
A1535	1964-72 clear 1751.99 set
A1535BK	1964-72 black 1614.99 set
A1535R	1964-72 red 1884.99 set
A1535P	1964-72 polished 1889.99 set
B & E-Body Models	
A1565	1962-72 clear 1569.99 set
A1565BK	1962-72 black 1655.99 set
A1565R	1962-72 red 1655.99 set
A1565P	1962-72 polished 1699.99 set

11.25" Rotors

Slotted and Plated Rotors

A-Body Models	
A1553BK	1965-72 clear 994.99 set
A1553BK	1965-72 black 1094.99 set
A1553R	1965-72 red 1094.99 set
A1553P	1965-72 polished 1144.99 set
B & E-Body Models	
A1553	1965-72 clear 994.99 set
A1553BK	1965-72 black 1094.99 set
A1553R	1965-72 red 1094.99 set
A1553P	1965-72 polished 1144.99 set

Big Bite Drilled Rotors

A-Body Models	
A1553D	1965-72 clear 1044.99 set
A1553DBK	1965-72 black 1144.99 set
A1553DR	1965-72 red 1144.99 set
A1553DP	1965-72 polished 1219.99 set
B & E-Body Models	
A1553D	1965-72 clear 1044.99 set
A1553DBK	1965-72 black 1144.99 set
A1553DR	1965-72 red 1144.99 set
A1553DP	1965-72 polished 1219.99 set

Rear Disc Brake Conversion Sets with Cast Iron Calipers

Rear disc brake conversion sets for 1960-72 Mopar models. Sets replace outdated drum brake components and add superior braking performance.



Includes 45mm 1-piston cast iron calipers with provisions for parking brakes. Also includes 10.5" unidirectional rotors with 5 x 4-1/2" bolt pattern, dust shields, brake hoses, pads and hardware. Fits 8-3/4" and Dana 60 axles. Calipers are available unfinished or in red or black powder coated finish. *Important: Models with cylinder engine must have 8-3/4" axle. All axles must have 5 x 4-1/2" bolt pattern and 2-1/2" brake spacing for correct installation. Fits 14" wheels. 1960-61 B-Body models must have two-piece axles with 10.5" drum brakes. Note: Shipped overweight.*

A-Body Models

A155	1965-72 unpainted 489.99 set
A155BK	1965-72 black 669.99 set
A155R	1965-72 red 669.99 set

Slotted and Plated Rotors

A155S	1965-72 unpainted 539.99 set
A155SBK	1965-72 black 719.99 set
A155SR	1965-72 red 719.99 set

B & E-Body Models

A1552*	1960-61 unpainted 529.99 set
A1552BK*	1960-61 black 689.99 set

B & E-Body Models Cont'd

Standard Vented Rotors	
A1552R*	1960-61 red 686.99 set
A155	1965-72 unpainted 489.99 set
A155BK	1965-72 black 669.99 set
A155R	1965-72 red 669.99 set

Slotted and Plated Rotors

A1552S*	1960-61 unpainted 579.99 set
A1552SBK*	1960-61 black 736.99 set
A1552SR*	1960-61 red 736.99 set
A155S	1965-72 unpainted 539.99 set
A155SBK	1965-72 black 719.99 set
A155SR	1965-72 red 719.99 set



STEERING, SUSPENSION, REAR END & BRAKES 1

Disc Brake Conversion Sets



1961-76 Forged Dynalite Front Brake Set

Forged Dynalite Pro Series front brake sets offer a drum-to-disc brake upgrade for 1961-76 Mopar A-Body, B-Body and E-Body models. Each set includes 11" vented iron rotors, forged-billet four piston calipers, low-noise low-dust brake pads, aluminum hubs and all bracketry, wheel bearings and mounting hardware. Dynalite Pro sets can be used with either manual or power assist master cylinders and replace 9" or 10" drum brakes or factory disc brakes utilizing the original spindles. Requires brake line set 2208307, sold separately.

Style A: smooth rotors and black anodized calipers
Style B: drilled rotors and black anodized calipers
Style C: drilled and slotted rotors and red powder coated calipers.

Important: May fit some 14" wheels, check wheel clearance diagram in installation instructions before purchase at www.wilwood.com

Note: No further discounts apply.

1961-76 A-Body

1961-72 Models with 9" Drum Brakes

14011022A 1961-72 all, style A..... 679.99 set
14011022B 1961-72 all, style B..... 784.99 set
14011022C 1961-72 all, style C..... 789.99 set

1961-72 Models with 10" Drum Brakes

14011023A 1961-72 all, style A..... 679.99 set
14011023B 1961-72 all, style B..... 699.99 set
14011023C 1961-72 all, style C..... 874.99 set

1973-76 Models with Disc Brakes

14011019A 1973-76 all, style A..... 669.99 set
14011019B 1973-76 all, style B..... 779.99 set
14011019C 1973-76 all, style C..... 779.99 set

1962-76 B-Body

1962-72 Models with Drum Brakes

14011020A 1962-70 all, style A..... 669.99 set
14011020B 1962-70 all, style B..... 764.99 set
14011020C 1962-70 all, style C..... 774.99 set

1970-72 Models with Disc Brakes

14011021A 1970-72 all, style A..... 679.99 set
14011021B 1970-72 all, style B..... 764.99 set
14011021C 1970-72 all, style C..... 869.99 set

1973-76 Models with Disc Brakes

14011019A 1973-76 all, style A..... 669.99 set
14011019B 1973-76 all, style B..... 779.99 set
14011019C 1973-76 all, style C..... 779.99 set

1970-74 E-Body

1970-72 Models with Drum Brakes

14011020A 1970-72 all, style A..... 669.99 set
14011020B 1970-72 all, style B..... 764.99 set
14011020C 1970-72 all, style C..... 774.99 set

1970-72 Models with Disc Brakes

14011021A 1970-72 all, style A..... 679.99 set
14011021B 1970-72 all, style B..... 764.99 set
14011021C 1970-72 all, style C..... 869.99 set

1973-74 Models with Disc Brakes

14011019A 1973-74 all, style A..... 669.99 set
14011019B 1973-74 all, style B..... 779.99 set
14011019C 1973-74 all, style C..... 779.99 set



1962-72 6 Drum to Disc Conversion Set

Wilwood's DynaPro 6 Series front disc brake conversion sets for 1962-72 B-Body and E-Body models. Includes 12.19" vented iron rotors, forged-billet calipers with six stainless pistons, Wilwood low-noise low-dust brake pads, aluminum hubs and all bracketry, wheel bearings and mounting hardware. Sets are offered in three different styles: style A includes smooth rotors and black anodized calipers; style B includes drilled rotors and black anodized calipers; style C includes drilled and slotted rotors and red powdercoated calipers. Set can be used with either manual or power assist master cylinders, and replaces factory drum brakes utilizing the existing spindles. Requires brake line set 2208307, sold separately.

Style A: smooth rotors and black anodized calipers

Style B: drilled rotors and black anodized calipers

Style C: drilled and slotted rotors and red powder coated calipers.

Important: May fit some 15" wheels, check wheel clearance diagram for more information.
Note: No further discounts apply.

B-Body

14010740A 1962-72 all, style A..... 949.99 set
14010740B 1962-72 all, style B..... 1044.99 set
14010740C 1962-72 all, style C..... 1099.99 set

E-Body

14010740A 1970-72 all, style A..... 949.99 set
14010740B 1970-72 all, style B..... 1044.99 set
14010740C 1970-72 all, style C..... 1099.99 set

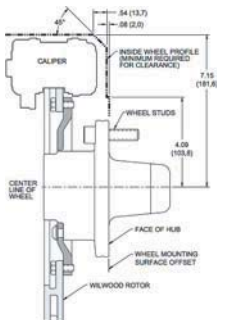

1962-72 6 Front Disc Brake Sets

Wilwood's billet forged Superlite 6 Series front disc brake conversion sets are a performance disc brake upgrade for 1962-72 B-Body and E-Body models. Includes 13.00" or 14.00" vented iron rotors, forged billet calipers with six stainless pistons, Wilwood low noise low-dust brake pads, aluminum rotor hats and all bracketry, wheel bearings and mounting hardware. Sets are offered in three different styles: style A includes smooth rotors and black anodized calipers; style B includes drilled rotors and black anodized calipers; style C includes drilled and slotted rotors and red powdercoated calipers. Set can be used with either manual or power assist master cylinders, and replaces factory drum brakes utilizing the existing spindles. Requires brake line set 2208307, sold separately.

Style A: smooth rotors and black anodized calipers

Style B: drilled rotors and black anodized calipers

Style C: drilled and slotted rotors and red powder coated calipers.

Important: Superlite 6 sets are hat sets, all other sets are hub sets. May require modifications to the original spindle.
Note: No further discounts apply.

13" Brake Rotor Kits

1962-72 B-Body with Drum Brakes

14010815A 1962-72 all, style A..... 1554.99 set
14010815B 1962-72 all, style B..... 1649.99 set
14010815C 1962-72 all, style C..... 1649.99 set

1970-72 E-Body with Drum Brakes

14010815A 1970-72 all, style A..... 1554.99 set
14010815B 1970-72 all, style B..... 1649.99 set
14010815C 1970-72 all, style C..... 1649.99 set

14" Brake Rotor Kits

1962-72 B-Body with Drum Brakes

14010816A 1962-72 all, style A..... 1674.99 set
14010816B 1962-72 all, style B..... 1774.99 set
14010816C 1962-72 all, style C..... 1774.99 set

1970-72 E-Body with Drum Brakes

14010816A 1970-72 all, style A..... 1674.99 set
14010816B 1970-72 all, style B..... 1774.99 set
14010816C 1970-72 all, style C..... 1774.99 set



Stainless Steel Braided Flexlines

Wilwood's stainless steel braided flexline sets are manufactured with the highest standards of quality. These universal flexline sets are required to complete the installation of a Wilwood front brake set. Set includes two 18" flexlines with 3/8" - 24 chassis fitting, two horseshoe clips and fitting adapters.

Note: No further discounts apply.

2208307 brake lines 59.99 set

Disc Brake Conversion Sets

New!



14011386



1960-76 Rear Parking Brake Set

Need a complete braking solution for your rear axle? Wilwood's Forged Dynalite Low-Profile Pro-Series rear disc brake sets offer balanced braking for all types of custom performance street/strip and show machines. Designed with clearance for 14" to 15" wheels and a neatly hidden internal parking brake system for a clean installation and superior static holding power. A 2.50" offset provides clearance for Mopar/Dana axles. Set includes forged billet four-piston calipers, 11" one-piece hat and rotor assemblies, snap ring bearings, and high friction pads.

Important: Requires snap ring style Green Bearing (MO40). May fit some 14" wheels. Check wheel clearance diagram in kit installation instructions before purchase. **Note:** Shipped overweight. No further discounts apply.

Black Anodized Calipers & Plain Rotors

14011386A	1960-76	A-body	649.99	set
14011386A	1962-76	B-body	649.99	set
14011386A	1970-74	E-body	649.99	set

Black Anodized Calipers & Drilled Rotors

14011386B	1960-76	A-body	749.99	set
14011386B	1962-76	B-body	749.99	set
14011386B	1970-74	E-body	749.99	set

Red Powder Coat Calipers & Drilled/Slotted Rotors

14011386C	1960-76	A-body	839.99	set
14011386C	1962-76	B-body	839.99	set
14011386C	1970-74	E-body	839.99	set

New!



1407144C



1960-76 Rear Parking Brake Set

Need a complete braking solution for your rear axle? Wilwood's Forged Dynalite rear disc brake sets offer balanced braking for all types of custom performance street/strip and show machines. Designed with clearance for 15" wheels and a neatly hidden internal parking brake system for a clean installation and superior static holding power. A 2.36" offset provides clearance for 8-3/4" Mopar/Dana 60 axles. Kit includes forged billet four-piston calipers with parking brake, 12" one-piece hat and rotor assemblies, snap ring bearings, and high friction pads.

Important: Requires snap ring style Green Bearing (MM506). May fit some 15" wheels. Check wheel clearance diagram in kit installation instructions before purchase. **Note:** Shipped overweight. No further discounts apply.

Black Anodized Calipers & Plain Rotors

1407144A	1960-76	A-body	649.99	set
1407144A	1962-76	B-body	649.99	set
1407144A	1970-74	E-body	649.99	set

Black Anodized Calipers & Drilled Rotors

1407144B	1960-76	A-body	754.99	set
1407144B	1962-76	B-body	754.99	set
1407144B	1970-74	E-body	754.99	set

Red Powder Coat Calipers & Drilled/Slotted Rotors

1407144C	1960-76	A-body	844.99	set
1407144C	1962-76	B-body	844.99	set
1407144C	1970-74	E-body	844.99	set

New!



26113269P

Wilwood Disc Brake Master Cylinders

Keep your custom brake system simple! This tandem chamber master cylinder and proportioning valve assembly keeps wiring and brake proportioning adjustments uncomplicated. Connect the fluid lines, bleed the system, and you're finished. Designed for non-power and power front disc/rear drum and four wheel disc brake applications, this beautifully crafted assembly features isolated front and rear fluid circuits and bolts directly to your firewall. Stainless steel button head fasteners, tube nuts, and precision bent lines offer years of rust-free performance. Available in natural finish, bright finish or Wilwood's exclusive black E-coat.

Important: DOT 3 or 4 brake fluid recommended. Not for use with DOT 5 silicone fluid.

Note: No further discounts apply.



1-1/8" Bore for Power-Assisted Brakes

26113270	natural finish	299.99	ea
26113270	bright finish	339.99	ea
26113270BK	black finish	339.99	ea

1" Bore for Manual Brakes

26113269	natural finish	299.99	ea
26113269P	bright finish	339.99	ea
26113269BK	black finish	339.99	ea

7/8" Bore for Manual Brakes

26113271	natural finish	299.99	ea
26113271P	bright finish	339.99	ea
26113271BK	black finish	339.99	ea



2608555P

Disc Brake Master Cylinders

These beautifully-crafted tandem-chamber master cylinders are configured for four wheel disc brake applications. They feature a slotted mounting flange that bolts to your brake booster or firewall. Manual brakes require 1" bore. Power assisted brakes use 1.12" bore. Features fluid outlets on both sides of the cylinder to simplify plumbing based on mount location. Available in a bright finish or Wilwood's exclusive black E-coat.

Note: No further discounts apply.

2608555P	1.12" bore, bright finish	209.99	ea
2608556BK	1.12" bore, black finish	239.99	ea
2608555P	1" bore, bright finish	199.99	ea
2608555BK	1" bore, black finish	239.99	ea



Wilwood BP-10 Brake Pads

Wilwood's exclusive BP-10 is an all new type of metallic-composite friction pad compound. BP-10 exhibits the medium to high temperature friction characteristics of a semi-metallic based race compound with the low temperature response, quiet engagement and lowered dust levels normally associated with ceramic based street performance pads. The combination of these characteristics make it the perfect choice for your street machine, auto crosser, or drag racer.

Note: No further discounts apply.

1508850K	Dynalite type 7112	39.99	set
1508855K	Superalite 6 type 7416	64.99	set
1501006K	DynaPro 6 type 6112	79.99	set



Parking Brake Cable Set

These cables will complete the installation of your Wilwood parking brake kit. These cable sets are compatible with all of Wilwood's internal drum parking brake sets including the Dynalite and Superlite kits. This cable will connect Wilwood's parking brake mechanism to your vehicle's OE equalizer assembly. The cables are simple to install and adjust and the cable housing's black finish disappears under the car for a clean looking undercarriage.

Note: No further discounts apply.

3309371	with clevis	109.99	set
---------	-------------	--------	-----

Disc Brake Conversion Sets



MNS5003



MNS5000

1963-74 Disc Brake Conversion Sets

Want to get rid of the drums and add disc brakes to your car? This set is what you need! Includes spindles, brackets, dust shields, loaded calipers, 11" rotors, bearings, seals, hoses and mounting hardware. A-Body sets include upper control arms and lower ball joints needed for this conversion.

Important: When changing from manual to power brake; two holes must be drilled in the firewall for the power booster bracket. Requires extra brake lines when converting from a single brake master to a dual brake master.

Note: A-Body sets include lower ball joints. **Includes stamped steel upper control arms. **Includes tubular upper control arms. Shipped overweight. No further discounts apply.

Manual Disc Brake Sets

A-Body Models
MNS5004* 1963-74 all models 599.99 set
MNS5005** 1963-74 all models 649.99 set

B & E-Body Models
MNS5003 1963-74 all models 399.99 set

Power Disc Brake Sets

A-Body Models
MNS5001* 1963-74 all models 899.99 set
MNS5002** 1963-74 all models 1069.99 set

B & E-Body Models
MNS5000 1963-74 all models 649.99 set



1963-74 Disc Brake Spindle & Bracket Kit

This set is for those who already have mid-70's brake calipers, rotors and hardware but need these specialty parts to finish the conversion on your 1963-74 B or E-Body. Includes spindles, brackets and dust shields for an economical conversion.

Note: No further discounts apply.

MNS5006 1963-74 B-Body 249.99 set
MNS5006 1970-74 E-Body 249.99 set



MD7587

1960-76 Front Disc Brake Conversion Sets

Looking to convert your Mopar A/B/E-Body to disc brakes? These sets include rotors, master cylinder, proportion valve and brake booster (on power brake sets). Available for manual or power brake systems in your choice of a standard setup (normal rotors, rubber hoses) or with cross drilled/slotted rotors, black powder coated calipers and braided stainless flex hoses. A-Body sets also include upper control arms and upper and lower ball joints.

Important: Rotors are 5 x 4-1/2" bolt pattern. **Note:** Shipped double overweight.

Manual Front Disc Brake Conversion

A-Body Models
MD7687 1960-76 standard 874.99 set
MD7688 1960-76 cross drilled/slotted, 989.99 set

B & E-Body Models
MD7587 1962-72 standard 524.99 set
MD7588 1962-72 cross drilled/slotted, 669.99 set

Power Front Disc Brake Conversion

A-Body Models
MD7685 1960-76 standard 1072.99 set
MD7686 1960-76 cross drilled/slotted, 1124.99 set

B & E-Body Models
MD7585 1962-72 standard 619.99 set
MD7586 1962-72 cross drilled/slotted, 764.99 set

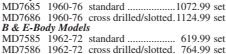

MD7787

1960-76 Front Disc Brake Conversion Sets

Want to convert to front disc brakes, but don't want to break the bank? This basic front brake upgrade (does not include master cylinder/booster) is a great option. This set includes rotors, calipers, lines, etc. Available as a standard setup with normal rotors and rubber flex hoses or with cross drilled/slotted rotors, black powder coated calipers and braided stainless flex hoses. A-Body sets also include upper control arms and upper and lower ball joints.

Important: Rotors are 5 x 4-1/2" bolt pattern. **Note:** Shipped double overweight.

A-Body Models

MD7787 1960-76 standard rotors 744.99 set
MD7788 1960-76 slotted & drilled rotors 889.99 set

B & E-Body Models
MD7785 1962-72 standard rotors 429.99 set
MD7786 1962-72 slotted & drilled rotors 569.99 set



MD7697

1960-76 Full Disc Brake Conversion Sets

Looking to convert your classic Mopar A/B/E-Body to 4-wheel disc brakes? These sets include rotors, master cylinder, proportion valve and brake booster (on power brake sets). Available for manual or power brake systems as a standard setup (with standard rotors and rubber hoses) or with cross drilled/slotted rotors, stainless steel flexlines and black powder coated calipers. A-Body sets also include upper control arms and upper and lower ball joints.

Important: Rotors are 5 x 4-1/2" bolt pattern. Requires "Green" rear axle bearings. **Note:** Shipped double overweight.

Manual 4-Wheel Disc Brake Conversion

A-Body
MD7697 1960-76 standard 1402.99 set
MD7698 1960-76 cross drilled/slotted, 1567.99 set

B-Body
MD7597 1962-72 standard 1039.99 set
MD7598 1962-72 cross drilled/slotted, 1259.99 set

E-Body
MD7597 1970-72 standard 1039.99 set
MD7598 1970-72 cross drilled/slotted, 1259.99 set

Power 4-Wheel Disc Brake Conversion

A-Body
MD7695 1960-76 standard 1512.99 set
MD7696 1960-76 cross drilled/slotted, 1677.99 set

B-Body
MD7595 1962-72 standard 1149.99 set
MD7596 1962-72 cross drilled/slotted, 1369.99 set

E-Body
MD7595 1970-72 standard 1149.99 set
MD7596 1970-72 cross drilled/slotted, 1369.99 set



MD7596



MD7789

8-3/4" & Dana 60 Rear Disc Brake Sets

Looking to convert your classic Mopar to rear disc brakes? This rear disc conversion set includes: brackets to mount the calipers, fully loaded new calipers, rotors, flex hoses, hardware and a pair of rear cables. Also available without the parking brake and cables.

Important: Rotors are 5 x 4-1/2" bolt pattern. Requires "Green" rear axle bearings (PIN MM3063).

Note: Shipped overweight.

MD7789 with parking brake 454.99 set
MD7790 without parking brake 344.99 set

Disc Brake Conversion Sets

New!



8-3/4" Rear End Disc Brake Conversion Kit

These 8-3/4" rear end disc brake conversions are for Mopar models with 8-3/4" rear end drum brakes. Standard kit includes plain rotors with rubber hoses, while the Deluxe kit includes drilled and slotted rotors with stainless steel hoses. Kits are designed to change everything at the wheel. Brake masters and proportioning valves are sold separately.

Front Disc Brake Kit Includes:

- 11" Plain Rotors with 5 x 4-1/2" bolt pattern - Standard Kit
- 11" Drilled and Slotted Rotors with 5 x 4-1/2" bolt pattern - Deluxe Kit
- Single Piston Calipers With Emergency Brakes
- Brackets
- Rubber Hoses - Standard Kit
- Stainless Steel Hoses - Deluxe Kit
- All Hardware



Note: Park brake cables must be purchased separately. Shipped overweight.

Standard 8-3/4" Rear Disc Brake Kit		
MP500550	8-3/4" rear end	449.99 kit
Deluxe 8-3/4" Rear Disc Brake Kit		
MP500551	8-3/4" rear end	499.99 kit

New!



MP500575



MP500575 detail

MP500575 detail

1966-74 Mopar A/B/E-Body Park Brake Cables

These park brake cables are for 1966-74 Mopar B/E-Body models using part numbers MP500550 or MP500551 8-3/4" rear end disc brake conversions. Brake cables are made of carbon steel for strength and reliability. Sold each.

Short Cables			
MP500579	1967-76	A-Body	34-3/4" 29.99 ea
MP500575	1966-70	B-Body	35-5/8" 29.99 ea
MP500577	1970-74	E-Body	35" 29.99 ea
Long Cables			
MP500580	1967-76	A-Body	73-3/4" 34.99 ea
MP500576	1966-70	B-Body	75-3/4" 34.99 ea
MP500578	1970-74	E-Body	72-3/4" 34.99 ea

New!



1962-74 B/E-Body Front Disc Brake Conversion Kit

These front disc brake conversions are for 1962-74 B/E-Body models with front drum brakes. Standard kit includes plain rotors with rubber hoses, while the Deluxe kit includes drilled and slotted rotors with stainless steel hoses. Kits are designed to change everything at the wheel. Brake master and proportioning valve are sold separately.

Front Disc Brake Kit Includes:

- 11" Plain Rotors with 5 x 4-1/2" bolt pattern - Standard Kit
- 11" Drilled and Slotted Rotors with 5 x 4-1/2" bolt pattern - Deluxe Kit
- Loaded Slider Type Single Piston Calipers
- Hubs with Bearings, Seals, Dust Caps, Spindle Nuts, Spindle Washers
- Backing Plates
- Stock Height Spindles
- Rubber Hoses - Standard Kit
- Stainless Steel Hoses - Deluxe Kit
- All Hardware



Note: Shipped overweight.

Standard Front Disc Brake Kit		
MP500510	1962-72	B-Body..... 449.99 kit
MP500510	1970-74	E-Body..... 449.99 kit
Deluxe Front Disc Brake Kit		
MP500511	1962-72	B-Body..... 499.99 kit
MP500511	1970-74	E-Body..... 499.99 kit

New!



Parking Brake Cable Clip and Bolt

This reproduction parking brake cable clip secures the right parking brake cable to the rear axle housing on Dana-equipped vehicles, and also secures the left parking brake cable to the vehicle body on some models. Manufactured from correct gauge steel and includes 5/16-18 flange head bolt plated in zinc phosphate.
MN8055 all 4.99 set

Disc Brake Conversion Sets

1963-72 True Bolt-On Disc Brake Conversion Sets

- No Need for Front End Alignment**
 Front disc brake conversion set eliminates the need for front end alignment because there's no need to change spindles.
- Easier and Quicker to Install**
 Because these sets bolt-on to your existing OEM spindles, installation time is greatly reduced.
- Greater Flexibility in Wheel Options**
 Sets for 1963-72 Mopar models available in a variety of rotor sizes for stock 14" diameter OE style wheels or for larger diameter custom wheels of your choice.



PB40013

1963-72 Mopar Front Disc Brake System w/Booster

Looking for a bolt-on front disc brake system for your classic Mopar? ABS Power Brakes has the answer. These sets from ABS Power Brakes utilize your OEM spindles. Each system includes brackets, a new 8" Dual Power Brake Booster Combo, master cylinder so you can select the correct combination (disc/drum or disc/disc). All rotors are 11-1/4" (requires 14" or larger wheels) and rotors are available plain or cross-drilled/slotted.

Note: Special order, must be prepaid. Shipped overweight.



Dodge Disc Brake Upgrade w/Booster

<i>For Vehicles with Bolt Pattern of 5 x 4" w/9" drums</i>			
<i>Note: Maintains 5 x 4" bolt pattern</i>			
PB40013	1963-72	A-Body plain.....	1239.99 set
PB40014	1963-72	A-Body cross-drilled/slotted.....	1349.99 set
<i>For Vehicles with Bolt Pattern of 5 x 4-1/2" w/10" drums</i>			
<i>Note: Upgrades existing bolt pattern to 5 x 4-1/2"</i>			
PB30013	1963-72	A-Body plain.....	1149.99 set
PB30014	1963-72	A-Body cross-drilled/slotted.....	1249.99 set
<i>For Vehicles with Bolt Pattern of 5 x 4" w/10" drums</i>			
PB40023	1965-72	A-Body plain.....	1239.99 set
PB40024	1965-72	A-Body cross-drilled/slotted.....	1349.99 set
<i>For Vehicles with Bolt Pattern of 5 x 4-1/2" w/10" drums</i>			
PB30023	1965-72	A-Body plain.....	1149.99 set
PB30024	1965-72	A-Body cross-drilled/slotted.....	1249.99 set
PB30033	1965-69	B-Body plain.....	1149.99 set
PB30034	1965-69	B-Body cross-drilled/slotted.....	1249.99 set
PB30043	1970-72	B-Body plain.....	1149.99 set
PB30044	1970-72	B-Body cross-drilled/slotted.....	1249.99 set

Plymouth Disc Brake Upgrade w/Booster

<i>For Vehicles with Bolt Pattern of 5 x 4" w/9" drums</i>			
<i>Note: Maintains 5 x 4" bolt pattern</i>			
PB40013	1963-72	A-Body plain.....	1239.99 set
PB40014	1963-72	A-Body cross-drilled/slotted.....	1349.99 set
<i>For Vehicles with Bolt Pattern of 5 x 4-1/2" w/9" drums</i>			
<i>Note: Upgrades existing bolt pattern to 5 x 4-1/2"</i>			
PB30013	1963-72	A-Body plain.....	1149.99 set
PB30014	1963-72	A-Body cross-drilled/slotted.....	1249.99 set
<i>For Vehicles with Bolt Pattern of 5 x 4" w/10" drums</i>			
PB40023	1965-72	A-Body plain.....	1239.99 set
PB40024	1965-72	A-Body cross-drilled/slotted.....	1349.99 set
<i>For Vehicles with Bolt Pattern of 5 x 4-1/2" w/10" drums</i>			
PB30023	1965-72	A-Body plain.....	1149.99 set
PB30024	1965-72	A-Body cross-drilled/slotted.....	1249.99 set
PB30033	1965-69	B-Body plain.....	1149.99 set
PB30034	1965-69	B-Body cross-drilled/slotted.....	1249.99 set
PB30043	1970-72	B-Body plain.....	1149.99 set
PB30044	1970-72	B-Body cross-drilled/slotted.....	1249.99 set

Rear Disc Brake Conversion Sets

- Simple Installation**
 Each conversion set comes with calipers, rotors, mounting brackets, parking brake cables and installation hardware.
- More Flexibility in Wheel Options**
 Upgrade for 1963-72 models providing for a modern disc brake system in the rear while retaining the use of OEM size wheels.
- High Quality Materials.**
 ABS Power Brake, Inc. brake components are manufactured with high quality materials to the highest manufacturing standards.

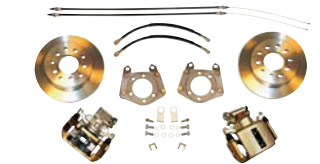

PB30015



PB30016

Bolt-On Rear Disc Upgrade Sets

Looking for a rear disc brake upgrade for your classic Mopar? ABS Power Brakes has the answer. Mounting to the OEM axle tubes, this set includes 11-1/4" (requires 14" or larger wheels) rotors and is available for either one piece axle or lock nut axle Mopar rear ends. Each system includes mounting brackets, calipers, parking brake cables and hardware. Available with plain or cross-drilled/slotted rotors. Fits Mopar 8-1/4", 8-3/4", 9-1/4", 9-3/4" and Dana 60 rear ends.

Note: Shipped overweight.



<i>One Piece Axle Rear Ends</i>			
PB40015	5 x 4" bolt pattern	plain.....	729.99 set
PB30015	5 x 4-1/2" bolt pattern	plain.....	639.99 set
PB40016	5 x 4" bolt pattern	cross-drilled/slotted.....	769.99 set
PB30016	5 x 4-1/2" bolt pattern	cross-drilled/slotted.....	689.99 set
<i>Lock Nut Axle Rear Ends</i>			
PB40025	5 x 4" bolt pattern	plain.....	729.99 set
PB30025	5 x 4-1/2" bolt pattern	plain.....	639.99 set
PB40026	5 x 4" bolt pattern	cross-drilled/slotted.....	769.99 set
PB30026	5 x 4-1/2" bolt pattern	cross-drilled/slotted.....	689.99 set

STEERING, SUSPENSION, REAR END & BRAKES

Electronic Disc Brake Conversion Sets

Remote Electric Hydraulic Pump Provides Power

- Eliminates the Bulky Original Booster**
 Gain valuable clearance in the firewall area by doing away with the unsightly and inefficient vacuum pump booster. A sleek billet aluminum master cylinder takes its place for enhanced appearance and performance.
- Increases Braking Pressure and Performance**
 This electronic system consistently provides 1400-2500 psi of braking pressure at the wheel, is self-contained and runs on brake fluid. Perfect upgrade for engines with low vacuum due to a performance cam.
- True Bolt-on - Requires No Vacuum**
 Replaces your OEM brake master cylinder. Features adjustable pedal rod to allow for correct pedal height.

Hi-tech remote electronic pump eliminates outdated and unsightly original vacuum booster

True bolt-on solution requires no change in spindles.



Eliminates firewall clutter and increases clearance.



Electric High Power Master Cylinder

Is the big cam in your Mopar causing a lack of braking power or do you have valve cover clearance issues? ABS Power Brakes has the answer - the electric brake master cylinder. Replace your OEM brake booster/master cylinder with a compact billet aluminum master cylinder which does not rely on vacuum for power assist, thanks to its own remotely mounted power supply. The fully self contained unit provides braking pressures between 1400 and 2500 psi. Measures 8" long and 3.5" wide. **Note: Shipped overweight.**



PB30001 all..... 1269.99 set

1963-72 Mopar Electronic Disc Brake Systems

Looking for a big brake upgrade for your classic 1963-72 Mopar? ABS Power Brakes has the answer. These solutions from ABS Power Brakes mount to your OEM brake spindles (require 14" or larger wheels) and feature 11-1/4" cross-drilled/slotted rods. Each system includes brackets and an ABS Power Brake Electric High Power Master Cylinder (EHPM - provides braking capacity for cars with big cams and additional valve cover clearance).

Note: Special orders must be prepaid. Shipped overweight.



Dodge Disc Brake Upgrade w/EHPM

For Vehicles with Bolt Pattern of 5 x 4" w/9" drums
Note: Retains 5 x 4" bolt pattern.

PB40012 1963-72 A-Body..... 2209.99 set

For Vehicles with Bolt Pattern of 5 x 4" w/9" drums

Note: Upgrades existing bolt pattern to 5 x 4-1/2"

PB30012 1963-72 A-Body..... 2139.99 set

For Vehicles with Bolt Pattern of 5 x 4" w/9" drums

PB40022 1965-72 A-Body..... 2209.99 set

For Vehicles with Bolt Pattern of 5 x 4-1/2" w/10" drums

PB30022 1965-72 A-Body..... 2139.99 set

PB30032 1965-69 B-Body..... 2139.99 set

PB30042 1970-72 B-Body..... 2139.99 set

PB30042 1970-72 E-Body..... 2139.99 set

Plymouth Disc Brake Upgrade w/EHPM

For Vehicles with Bolt Pattern of 5 x 4" w/9" drums
Note: Maintains 5 x 4" bolt pattern

PB40012 1963-72 A-Body..... 2209.99 set

For Vehicles with Bolt Pattern of 5 x 4" w/9" drums

Note: Upgrades existing bolt pattern to 5 x 4-1/2"

PB30012 1963-72 A-Body..... 2139.99 set

For Vehicles with Bolt Pattern of 5 x 4" w/10" drums

PB40022 1965-72 A-Body..... 2209.99 set

For Vehicles with Bolt Pattern of 5 x 4-1/2" w/10" drums

PB30032 1965-69 B-Body..... 2139.99 set

PB30042 1970-72 B-Body..... 2139.99 set

Sleek billet aluminum master cylinder provides an enhanced appearance and high performance braking.



1963-72 Mopar Standard Front Disc Brake Systems

Looking to upgrade from old drum brakes to disc brakes on the front of your classic Mopar? ABS Power Brakes has the answer. These solutions from ABS Power Brakes mount to your OEM brake spindles (require 14" or larger wheels) and feature your choice of 11-1/4" plain or cross-drilled and slotted rods. System includes brackets.

Important: These sets do not come with brake booster or Electric High Power Master.

Note: Special orders must be prepaid. Shipped overweight.



Dodge Disc Brake Upgrade

For Vehicles with Bolt Pattern of 5 x 4" w/9" drums
Note: Maintains 5 x 4" bolt pattern

PB40010 1963-72 A-Body plain..... 899.99 set

PB40011 1963-72 A-Body cross-drilled/slotted..... 999.99 set

For Vehicles with Bolt Pattern of 5 x 4" w/9" drums

Note: Upgrades existing bolt pattern to 5 x 4-1/2"

PB30010 1963-72 A-Body plain..... 799.99 set

PB30011 1963-72 A-Body cross-drilled/slotted..... 899.99 set

For Vehicles with Bolt Pattern of 5 x 4" w/10" drums

PB40020 1965-72 A-Body plain..... 899.99 set

PB40021 1965-72 A-Body cross-drilled/slotted..... 999.99 set

For Vehicles with Bolt Pattern of 5 x 4-1/2" w/10" drums

PB30020 1965-72 A-Body plain..... 799.99 set

PB30021 1965-72 A-Body cross-drilled/slotted..... 899.99 set

PB30030 1965-69 B-Body plain..... 799.99 set

PB30031 1965-69 B-Body cross-drilled/slotted..... 899.99 set

PB30040 1970-72 B-Body plain..... 799.99 set

PB30041 1970-72 B-Body cross-drilled/slotted..... 899.99 set

Plymouth Disc Brake Upgrade

For Vehicles with Bolt Pattern of 5 x 4" w/9" drums
Note: Maintains 5 x 4" bolt pattern

PB40010 1963-72 A-Body plain..... 899.99 set

PB40011 1963-72 A-Body cross-drilled/slotted..... 999.99 set

For Vehicles with Bolt Pattern of 5 x 4" w/9" drums

Note: Upgrades existing bolt pattern to 5 x 4-1/2"

PB30010 1963-72 A-Body plain..... 799.99 set

PB30011 1963-72 A-Body cross-drilled/slotted..... 899.99 set

For Vehicles with Bolt Pattern of 5 x 4" w/10" drums

PB40020 1965-72 A-Body plain..... 899.99 set

PB40021 1965-72 A-Body cross-drilled/slotted..... 999.99 set

For Vehicles with Bolt Pattern of 5 x 4-1/2" w/10" drums

PB30020 1965-72 A-Body plain..... 799.99 set

PB30021 1965-72 A-Body cross-drilled/slotted..... 899.99 set

PB30030 1965-69 B-Body plain..... 799.99 set

PB30031 1965-69 B-Body cross-drilled/slotted..... 899.99 set

PB30040 1970-72 B-Body plain..... 799.99 set

PB30041 1970-72 B-Body cross-drilled/slotted..... 899.99 set

Brake Booster Sets



1965-74 Disc Brake Master Cylinder/Booster Assembly

All new master cylinder brake booster assembly for various 1965-74 Mopar models. Features a raw cast iron master cylinder, anodized gold 8" dual-diaphragm booster, firewall bracket, and brake pedal linkage. The dual bowl master cylinder included is ideal for front disc/rear drum or front drum/rear drum applications. The combination unit is built to the highest quality standards and comes ready to install.

MM3066 1965-74 B-Body 204.99 ea
MM3066 1970-74 E-Body 204.99 ea



MN5007

1963-74 Disc Brake Master Cylinder/Booster Sets

When adding disc brakes, a disc brake master cylinder and proportioning valve is needed and a power booster is highly recommended due to increased line pressure. This set includes an 8" dual diaphragm brake booster, firewall bracket assembly, master cylinder, proportioning valve for disc/drum or disc/disc, pedal pushrod and mounting hardware.

Note: No further discounts apply.

Disc/Drum Brake Applications

MN5007 1963-74 B-Body 299.99 set
MN5007 1970-74 E-Body 299.99 set

Disc/Disc Brake Applications

MN5008 1963-74 B-Body 299.99 set
MN5008 1970-74 E-Body 299.99 set



A28144

1962-72 Disc Brake Master Cylinder/Booster Combination

This booster and master cylinder built specifically with disc brake conversions in mind. The booster has an anodized gold finish and the master cylinder is in raw cast color. Strict quality-control measures are employed to make this assembly last the life of your vehicle. Available with a 9" booster or a 7" dual diaphragm booster for those big engine installations.

Note: Master cylinder/booster cylinder combination is not for vehicles originally equipped with power brakes.

B & E-Body Models

With 7" Dual Diaphragm Booster
A28145 1962-72 natural finish 204.99 ea
A28145C 1962-72 chrome finish 242.99 ea

B & E-Body Models

With 9" Single Diaphragm Booster
A28144 1962-72 natural finish 179.99 ea
A28144C 1962-72 chrome finish 199.99 ea

New!



MB850200



MD850300

1966-74 B/E Body Brake Booster Sets

Bring your Mopar to a safe stop with these original style reproduction brake boosters and master cylinders! These Bendix style trapezoid nose booster sets for B and E-body models are available with a stud 1" bore master cylinder for 4 wheel drum brakes, or a 4 stud 1.125" bore master cylinder for vehicles with front disc and rear drum brakes. Includes mounting bracket.

Drum/Drum Brakes

MB850200 1966-70 B-body 389.99 set

Disc/Drum Brakes

MD850300 1966-70 B-body 389.99 set
MD850301 1971-74 B-body 389.99 set
MD850301 1970-74 E-body 389.99 set

New!



MP500500



MP500502



MP500501

1966-74 Mopar Style Booster

Reproduction power booster for 1966-74 B/E body models is a direct replacement. Mopar style booster features the bendix style trapezoidal nose and accepts the 4 stud master cylinder and is painted black. Replace that old booster with a new reproduction booster.

Recommend: Replacing the reinforcement fiber plate at the same time.

Power Brake Booster

MP500502 1966-69 B-body 299.99 ea
MP500512 1970-74 B/E-body 299.99 ea

Booster Firewall Reinforcement Plates

Reproduction booster firewall reinforcement plates are used on 1966-74 B/E body models. These are made of heavy gauge steel with correct hole placement and painted black. Includes pedal bracket swivel and extension.
MP500500 1966-69 B-body 109.99 set
MP500501 1970-74 B-body 109.99 set
MP500501 1970-74 E-body 109.99 set

New!



1966-74 Bendix Style Master Cylinder

Cast iron bendix style master cylinder for 1966-1974 B/E-Body models with disc/drum manual or power brake applications. Features the casting number 2227161, a 1.125" bore, and ports 9/16"-20 INV and 1/2"-20 INV, with internal residual valves. Includes mounting holes for manual applications and is painted black. Manual rod mounting kit available.

MP500505 1966-72 B-Body 124.99 ea
MP500505 1970-74 E-Body 124.99 ea

New!



1966-74 Bendix Style Master Cylinder

Cast iron bendix style master cylinder for 1966-1974 B/E-Body models with drum/drum manual or power brake applications. It features a 1" bore, and ports 9/16"-20 INV and 1/2"-20 INV, with internal residual valves. Includes the original style zinc lid with the hold down bracket, mounting holes for manual applications and cast finished. Manual rod mounting kit available.

MP500506 1966-72 B-Body 124.99 ea
MP500506 1970-74 E-Body 124.99 ea



A04711



plain finned flamed ball milled

1965-75 Billet Aluminum Master Cylinders

Dress up your engine compartment with a billet aluminum dual-bowl master cylinder. Fits most standard Mopar 4-bolt mounting configurations. Choose from 4 different style caps.

Note: For disc/drum brake applications only. Not for drum/drum applications.

Manual and Factory Power Brakes

1-1/32" Bore Master Cylinders
A04711 1965-75 plain cap 359.99 ea
A04712 1965-75 finned cap 359.99 ea
A04713 1965-75 flamed cap 379.99 ea
A04715 1965-75 ball milled cap 349.99 ea



1962-72 Master Cylinder w/Billet Cap

This replacement master cylinder features a beautiful billet cap and stainless steel bale that will not rust. Includes dual outlet master cylinder with billet aluminum master cylinder cap, stainless bales and hardware.
A2931 1962-72 A/B/E-Body 149.99 ea

Master Cylinders



1960-75 Replacement Brake Master Cylinders

Replacement hydraulic brake master cylinders use both aluminum and cast iron castings for an exact match to your vehicle. Technologically advanced components ensure safe and reliable braking. With these premium products, you can be certain that your replacement brake master cylinder will perform as good as your original equipment.

Note: *PIN MC36221 can be used on both manual or power brakes.

Manual Drum Brakes

A-Body	Year	Model	Price
MC34330	1960-66	all models	49.99 ea
MC36221*	1967-70	all models	34.99 ea
MC36308	1971-72	Plymouth models	49.99 ea
MC36338	1971-74	all, 9" brakes	54.99 ea
MC36439	1973-74	all, 10" brakes	69.99 ea

B-Body	Year	Model	Price
MC36045	1962-65	all models	69.99 ea
MC36200	1966	all models	69.99 ea
MC36221*	1967-70	all models	34.99 ea
MC36221*	1968	Road Runner	34.99 ea

E-Body	Year	Model	Price
MC36221*	1970	all	34.99 ea
MC36308	1971-72	all	49.99 ea

Power Drum Brakes

A-Body	Year	Model	Price
MC36218	1960-66	all models	44.99 ea

B-Body	Year	Model	Price
MC36218	1962-66	all models	44.99 ea
MC36221*	1967-70	all models	34.99 ea
MC36221*	1968	Road Runner	34.99 ea
MC36309	1971-72	all models	39.99 ea

E-Body	Year	Model	Price
MC36221*	1970	all	34.99 ea
MC36309	1971-72	*Cuda, Barracuda	39.99 ea

Power Disc Brakes

A-Body	Year	Model	Price
MC36221*	1970	Dart, Valiant	34.99 ea
MC36426	1971-72	all models	49.99 ea
MC36406	1973-75	all models	49.99 ea

B-Body	Year	Model	Price
MC36283	1970	all models	44.99 ea
MC36307	1971-72	all models	39.99 ea

E-Body	Year	Model	Price
MC36283	1970	all	44.99 ea
MC36307	1971-74	all	39.99 ea

1962-76 Low Pressure Brake Switch

This low pressure hydraulic brake pressure switch has a much longer life than previous models available anywhere. This unit fits most cars and requires 20-50 pounds pressure, instead of stock units that need 60-120 pounds pressure to engage. Standard 1/8" pipe thread (9/16"-18). This switch is D.O.T. compliant and is compatible with silicone-based brake fluid.

TF900650 1962-76 31.99 ea

1960-76 Master Cylinder Gasket

Master cylinder gasket for most 1960-76 A, B and E-Body Dodge and Plymouth models with or without power brakes. Made in USA.

MD2092 1960-76 all 2.99 ea

1966-74 Booster to Firewall Gasket

Power brake booster to firewall gasket for most 1966-74 A and B-Body and 1970-74 E-Body Dodge and Plymouth models equipped with power brakes. Made in USA.

MD2090 1966-74 all w/power brakes .. 2.99 ea

1962-65 Master Cylinder to Plate Gasket

Master cylinder to plate gasket for most 1962-65 B-Body vehicles. Made in USA.

MB2185 1962-65 w/o power brakes 7.99 ea
MB2186 1962-65 w/power brakes 7.99 ea

Master Cylinder Mount Adaptor Set

This master cylinder mount set from Mopar Performance is designed to convert an OE four-stud to a two stud master cylinder without drilling holes into your firewall. Includes hardware for mounting master cylinder.

Note: Reuse hardware for mounting bracket to firewall.

MD47275 except 1968 A-Body Hemi... 46.99 set

1968 Offset Master Cylinder Adapter Set

This offset master cylinder set from Mopar Performance moves the master cylinder away from the engine to provide clearance for Hemi or 440 engine valve covers. Designed for 1968 Hemi A-Body cars, this set may be used for other A-body applications with 426 Hemi engines. Includes hardware for mounting master cylinder.

Note: Reuse hardware for mounting bracket to firewall.

MD47276 1968 A-Body w/Hemi 129.99 set

Adjustable Master Cylinder Pushrod Set

This universal adjustable pushrod set accommodates clevis, clevis, and bell crank style pushrod setups. Includes adapters for 10 common master cylinder pushrod configurations with both power and manual brake systems.

A1726 59.99 set

Adjustable Brake Pushrod

This adjustable brake pushrod from Mopar Performance is great for brake master cylinder conversions, especially when changing from a four-hole to a two-hole mount. Get the correct adjustment for pedal height. Recommended for MD47275 brake master cylinder adapter.

MD47277 all 79.99 ea

Power Brake Vacuum Hose Fitting

Reproduction intake manifold fitting for power brake vacuum hose on models with power brakes without air conditioning or Air Grabber. Features correct tail hex and 3/8" NPT threads and silver cadmium plating as original.

Note: Will not fit 1968-69 Dodge Charger models.

A, B, E-Body (Except 1968-69 Charger)
MD431005 w/o AC or Air Grabber 12.99 ea

Replacement Brake Parts



1985-72 Electronic Vacuum Pump Set

It takes 16 inches of vacuum to properly activate your vehicle's power brake booster. Sometimes, big-cammed or supercharged engines don't create enough vacuum to operate the booster, which can make braking difficult. This vacuum pump set will boost your booster with the needed vacuum so your brakes will function properly.

VP28146 1965-72..... 289.99 set

SSBC
PERFORMANCE BRAKE SYSTEMS

SSBC
PERFORMANCE BRAKE SYSTEMS



A0707



A0730

Adjustable Proportioning Valves

These proportioning valves from SSBC are designed to regulate and adjust brake fluid pressure. Each valve has an adjuster knob for "on the fly" adjustments to braking bias. Choose from just the proportioning valve, a combination valve and pressure gauge or a combination proportioning valve and distribution block with a built-in brake lamp switch. These valves are great for race cars, tow vehicles or any car that requires specialized and adjustable brake pressure bias.

Proportioning Valve Only

A0707 black anodized finish..... 49.99 ea

Proportioning Valve and Distribution Block

A0730 black anodized finish..... 84.99 ea

A0730P polished finish..... 119.99 ea



Proportioning Valve

Precision proportioning from 100 to 1,000 PSI. At full release, valve is capable of up to 57% reduction in line pressure. The new smaller body accommodates easy mounting in a variety of locations in conjunction with two .25" diameter holes on 1.00" centers. Standard 1/8"-27 NPT inlet and outlet ports and two 1/8"-27 NPT to 3/8"-24 inverted flare brake line adapters included makes installation simple.

Note: No further discounts apply.

2608419 knob style..... 41.99 ea

SSBC
PERFORMANCE BRAKE SYSTEMS



MD2267

MD2268



MD2270

MD2269

1967-75 Brake Valves

Brake valves for 1967-75 A, B, & E-Body vehicles. Factory correct finish. Available in both distribution and combination distribution/proportioning valves.

1967-75 A-Body Brake Valves

Note: *1967-70 vehicles with front disc also require a proportioning valve sold separately.

Distribution Valves

MD2267* 1967-70 disc..... 93.99 ea

MD2267 1967-75 drum..... 93.99 ea

Combination Valves

MD2268 1969-75 disc..... 99.99 ea

1967-74 E-Body Brake Valves

Note: *1967-70 vehicles with front disc also require a proportioning valve sold separately.

Distribution Valves

MD2267* 1967-70 disc..... 93.99 ea

MD2267 1967-70 drum..... 93.99 ea

MD2270 1971-74 drum..... 93.99 ea

Combination Valves

MD2268 1969-70 disc..... 99.99 ea

MD2271 1971 disc..... 104.99 ea

Metering Valves

MD2269 1969-70 disc..... 93.99 ea

MD2273 1971 disc..... 93.99 ea

1970-74 E-Body Brake Valves

Note: *1970-71 vehicles with front disc also require a proportioning valve sold separately.

Distribution Valves

MD2270* 1970-71 disc..... 93.99 ea

MD2270 1970-74 drum..... 93.99 ea

Combination Valves

MD2271 1970-71 disc..... 104.99 ea

Metering Valves

MD2273 1970-71 disc..... 93.99 ea



1967-71 Proportioning Valve

Utilized in conjunction with the distribution valve on vehicles with front disc and rear drum brakes, this proportioning valve is designed to prevent rear wheel lockup during sudden braking by limiting pressure to the rear brakes. For 1967-70 A-body and B-body vehicles and 1970-71 E-body vehicles.

MD2274 1967-71..... 82.99 ea

New!



1967-74 Prop Valve w/Metering Block

This combination proportioning valve with metering valve is for 1967-74 A, B, & E-Body models with disc/drum brakes. This combination valve includes tee, proportioning valve, and metering valve mounted together. This is a great replacement combination for your old combination and metering valve.

Important: You may have to make new lines because of the metering valve being mounted to the proportioning valve on some models.

MP500503 1967-74 A-Body..... 124.99 ea

MP500503 1967-74 B-Body..... 124.99 ea

MP500503 1970-74 E-Body..... 124.99 ea



MN1151

MN1152

MN1153

MN1154

1962-66 Distribution Blocks

Factory replacement distribution blocks, with correct shape and size. Available for 1962-66 A-body and B-body vehicles. Conversion blocks for use when converting to dual master cylinder or disc brakes also available.

Factory Replacement Block

MN1151 1962-64..... 34.99 ea

MN1152 1965-66..... 34.99 ea

Conversion Block

MN1153 1962-64..... 38.99 ea

MN1154 1965-66..... 38.99 ea

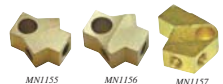

MN1155

MN1156

MN1157

1962-76 Brass Axle Tee Blocks

Exact replacement 1962-76 A-Body, B-Body and E-Body axle distribution blocks. Brass "tee" block mounts to axle tube. Features factory correct size, shape and thickness.

Note: *Vehicles with 8-3/4 rear axle, **Vehicles with Dana rear axle, ***Vehicles with Dana or 8-3/4 rear axle

1962-76 A-Body Tee Blocks

MN1155 1962-66 tee block..... 21.99 ea

MN1156* 1967-69 tee block..... 21.99 ea

MN1155 1970-71 tee block..... 21.99 ea

MN1157 1972-76 tee block..... 26.99 ea

1966-74 B-Body Tee Blocks

MN1156** 1966-69 tee block..... 21.99 ea

MN1155** 1967-69 tee block..... 21.99 ea

MN1155*** 1970 tee block..... 21.99 ea

MN1157 1971-74 tee block..... 26.99 ea

1970-74 E-Body Tee Blocks

MN1157 1970-74 tee block..... 26.99 ea

1 STEERING, SUSPENSION, REAR END & BRAKES

Brake Tools



X2189

Tubing Benders

These tools make bend easy without the tube collapsing. Tube benders can be used for bending copper or steel tubing such as brake, fuel, transmission cooler or power steering lines.

X2189 3/16", 1/4", 5/16" & 3/8" 27.99 ea

V025700 5/16" & 3/8" lines 49.99 ea



Y10950

Brake Line Wrenches

Brake line wrenches for various drum and disc brake applications. Designed to prevent stripping brake line ends.

Brake Bleeder Wrenches

Y10950 1/4" x 3/8" 8.99 ea

Y10900 5/16" x 3/8" 8.99 ea



Brake System Power Bleeder

Bleed your hydraulic brake system like the pros with this high-capacity brake bleeder system. This is a simple, one person operation with no external power source needed. Includes a precision pressure gauge for safe operation and you can flush the entire hydraulic system without frequently refilling the reservoir. This unit features a large reservoir that holds up to 2 quarts of brake fluid. Complete system includes reservoir with gauge, hoses, fittings, instructions as well as 2 adapters that will fit most master cylinders from 1947-present.

14227 power bleeder 99.99 ea



04000

Mityvac Brake Bleeding Kit

The Mityvac Brake Bleeding Kit may be used on virtually all hydraulic systems as well as most ABS systems. It's rugged, low-cost professional tool which enables one person to efficiently bleed brakes, clutches, or other hydraulic systems. Choose from our sturdy polymer plastic bleeder, designed for occasional use by the do-it-yourselfer, or step up to the heavy-duty metal bleeder designed for the professional mechanic. 04000 "professional" model 99.99 set

06820 "do-it-yourselfer" model 44.99 set



SSBC
PERFORMANCE BRAKE SYSTEMS

Brake Pressure Gauge

With this brake pressure gauge you will be able to measure your braking pressure right at the caliper where it is the most accurate. The gauge comes with the six most common fitting sizes to adapt this versatile gauge right to the threaded bleeder port of either your caliper or drum system. Get the correct brake balancing with the best tool for the job.

A1704 49.99 set



Y50700

Brake Pad Spreader

This unique tool makes changing disc brake pads easy. The tool compresses the disc brake piston for easy installation of pads

Y24400 9.99 ea



Double Flaring Tool Set

If your brake or fuel lines need to be flared, this is the right tool for you. This set allows the user to make single or double SAE flares to exact dimensions. Great item to keep in your tool box.

Y31310 54.99 set



Brake Caliper/Brake Drum Paint System

EZ brush-on application, high-gloss finish, and the highest heat resistance on the market. Withstands temperatures of up to 950° F! Kit includes two-component paint system, brake caliper cleaner, brush and mixing stick. Choose from red, yellow, blue, silver, black, purple, green, white, gold, orange or pink. Contains enough paint for 4 large calipers or 2 brake drums.

G22160 specify color 39.99 set



X298

Drum Brake Adjusting Tools

Tools to ease the installation and removal of various drum brake components including shoe retaining springs, tension springs, and shoes.

Brake Spring Pliers

X298 tension spring tool 19.99 ea

Adjusting Wheel Tool

Y50700 brake adjustment tool 5.99 ea

Brake Spring Removal Tools

Y44800 heavy duty 18.99 ea

Y44800 standard 11.99 ea

Brake Shoe Retaining Spring Tool

X280 retaining spring tool 8.99 ea



High Performance Brake Fluid

Wilwood offers two grades of high performance brake fluid. Hi-Temp® 570 has a maximum dry boiling point to withstand severe heat in street and track use. EXP 600 Plus has a maximum dry boiling point of 626° developed for extreme performance under the high heat and extreme pressure of professional motorsports. Both fluids are available in convenient 6 packs. Always add new fluid to a clean system.

Note: No further discounts apply.

EXP 600 Brake Fluid

2908478 6 pack of 16.9 oz bottles 109.99 ea

Hi-Temp® 570 Brake Fluid

2902210 6 pack of 12 oz bottles 47.99 ea



Brake & Parts Cleaner

This powerful brake & parts cleaner cuts through grease and grime without leaving an oily film. This fast drying formula gets the job done using less spray compared to watered-down cleaners. Non-Chlorinated.

JG1210 14 oz can 4.99 ea

JG1210 6 can of 12 - 14 oz cans 54.99 ea

A-Body Brake Lines



Each line is produced with all correct bends to match the factory equipment exactly. Couple precise manufacturing techniques with superior materials and you can be assured that you are installing the best lines available on the market. Lines are machine double flared for a safe, no leak fit. Each line is labeled for your convenience and pre-fitted for easy installation. Applications are available for most 1962-75 A-body vehicles in your choice of galvanized steel or never-rust stainless steel.

Important: Front brake line sets include master cylinder lines and left front and right front brake lines. They are correct for cars with disc or drum brakes. Lines for the disc brake calipers or drum brake wheel cylinders are sold separately.



1962-75 A-Body Brake Line Sets

1962-75 OEM Material Front Brake Lines

YKT6201R	1962	3 lines	manual drum	54.99 set
YKT6301R	1963	3 lines	manual drum	54.99 set
YKT6501R	1964-65	3 lines	standard brakes	54.99 set
YKT6601R	1966	3 lines	standard brakes	54.99 set
YKT6701R	1967	4 lines	standard brakes	54.99 set
YKT6702R	1967	4 lines	power brakes	54.99 set
YKT6801R	1968-72	4 lines	standard brakes	54.99 set
YKT6802R	1968-72	4 lines	power brakes	54.99 set
YKT7301R	1973	4 lines	standard brakes	54.99 set
YKT7302R	1973	4 lines	power brakes	54.99 set
YKT7501R	1975	4 lines	standard drum	54.99 set

1962-75 OEM Material Front to Rear Brake Lines

Important: *Requires part # MD2274 hold-off valve sold separately.

Note: Shipped double oversize.

				882
YIN6502R	1964-65	1 line	all	54.99 ea
YIN6602R	1966	1 line	all	54.99 ea
YIN6703R	1967-69	1 line	with drum brakes	54.99 ea
YIN6704R*	1967-69	2 lines	with disc brakes	54.99 pr

				882
Dart				
YIN6301R	1963	1 line	all (except 4-door)	54.99 ea
YIN6302R	1963	1 line	4-door	54.99 ea
YIN6502R	1964-65	1 line	all (except 4 door)	54.99 ea
YIN6504R	1965	1 line	4 door	54.99 ea
YIN6602R	1966	1 line	all	54.99 ea
YIN6701R	1967-70	1 line	all with drum brakes	54.99 ea
YIN6702R*	1967-70	2 lines	with disc brakes	54.99 pr
YIN6701R	1971-72	1 line	all	54.99 ea
YIN7301R	1973	1 line	all	49.99 ea
YIN7401R	1974	1 line	with power disc	54.99 ea
YIN7501R	1975	1 line	Swinger with drum	54.99 ea

Demon/Dart Sport				
YIN6703R	1971-72	1 line	all	54.99 ea
YIN7302R	1973	1 line	all	49.99 ea

Duster				
YIN6703R	1970	1 line	with drum brakes	54.99 ea
YIN6704R*	1970	2 lines	with disc brakes	54.99 pr
YIN6703R	1971-72	1 line	all	49.99 ea
YIN7302R	1973	1 line	all	49.99 ea

Lancer				
YIN6201R	1962	1 line	all	54.99 ea

Scamp				
YIN6701R	1971-72	1 line	all	54.99 ea
YIN7302R	1973	1 line	all	49.99 ea

Valiant				
YIN6201R	1962	1 line	all	54.99 ea
YIN6301R	1963	1 line	all (except 4 door)	54.99 ea
YIN6302R	1963	1 line	4-door	54.99 ea
YIN6502R	1964-65	1 line	all (except 4 door)	54.99 ea
YIN6602R	1966	1 line	all	54.99 ea
YIN6703R	1967	1 line	with drum brakes	54.99 ea
YIN6704R*	1967-70	2 lines	with disc brakes	54.99 pr
YIN6703R	1971-72	1 line	all	54.99 ea
YIN7302R	1973	1 line	all	49.99 ea

1963-75 OEM Material Axle Brake Lines

YRA6502R	1963-66	2 lines	all	24.99 pr
YRA6701R	1967-69	2 lines	7-1/4" rear axle	24.99 pr
YRA6702R	1967-69	2 lines	8-3/4" rear axle	24.99 pr
YRA7001R	1970-72	2 lines	8-3/4" rear axle	24.99 pr
YRA7003R	1970-72	2 lines	7-1/4" rear axle	24.99 pr
YRA7301R	1973	2 lines	8-3/4" rear axle	24.99 pr
YRA7302R	1973	2 lines	9-1/4" rear axle	24.99 pr
YRA7303R	1973-75	2 lines	8-1/4" rear axle	24.99 pr
YRA7501R	1975	2 lines	Dart Swinger	24.99 pr

1962-75 Stainless Steel Front Brake Lines

YKT6201S	1962	3 lines	manual drum	79.99 set
YKT6301S	1963	3 lines	manual drum	79.99 set
YKT6501S	1964-65	3 lines	standard brakes	79.99 set
YKT6601S	1966	3 lines	standard brakes	79.99 set
YKT6701S	1967	4 lines	standard brakes	79.99 set
YKT6702S	1967	4 lines	power brakes	79.99 set
YKT6801S	1968-72	4 lines	standard brakes	79.99 set
YKT6802S	1968-72	4 lines	power brakes	79.99 set
YKT7301S	1973	4 lines	standard brakes	79.99 set
YKT7302S	1973	4 lines	power brakes	79.99 set
YKT7501S	1975	4 lines	standard drum	79.99 set

1962-75 Stainless Steel Front to Rear Brake Lines

Important: *Requires part # MD2274 hold-off valve sold separately.

Note: Shipped double oversize.

				882
Baracuda				
YIN6602S	1966	1 line	all	79.99 ea
YIN6602S	1966	1 line	all	79.99 ea
YIN6703S	1967-69	1 line	with drum brakes	79.99 ea
YIN6704S*	1967-69	2 lines	with disc brakes	79.99 pr

				882
Dart				
YIN6301S	1963	1 line	all (except 4-door)	79.99 ea
YIN6302S	1963	1 line	4-door	79.99 ea
YIN6502S	1964-65	1 line	all (except 4 door)	79.99 ea
YIN6504S	1965	1 line	4 door	79.99 ea
YIN6602S	1966	1 line	all	79.99 ea
YIN6701S	1967-70	1 line	with drum brakes	79.99 ea
YIN6702S*	1967-70	2 lines	with disc brakes	79.99 pr
YIN6701S	1971-72	1 line	all	79.99 ea
YIN7301S	1973	1 line	all	69.99 ea
YIN7401S	1974	1 line	with power disc	79.99 ea
YIN7501S	1975	1 line	Swinger with drum	79.99 ea

Demon/Dart Sport				
YIN6703S	1971-72	1 line	all	79.99 ea
YIN7302S	1973	1 line	all	69.99 ea

Duster				
YIN6703S	1970	1 line	with drum brakes	79.99 ea
YIN6704S*	1970	2 lines	with disc brakes	79.99 pr
YIN6703S	1971-72	1 line	all	79.99 ea
YIN7302S	1973	1 line	all	69.99 ea

Lancer				
YIN6201S	1962	1 line	all	79.99 ea

Scamp				
YIN6701S	1971-72	1 line	all	79.99 ea
YIN7302S	1973	1 line	all	69.99 ea

Valiant				
YIN6201S	1962	1 line	all (except 4 door)	79.99 ea
YIN6301S	1963	1 line	all (except 4 door)	79.99 ea
YIN6302S	1963	1 line	4-door	79.99 ea
YIN6502S	1964-65	1 line	all (except 4 door)	79.99 ea
YIN6602S	1966	1 line	all	79.99 ea
YIN6703S	1967-70	1 line	with drum brakes	79.99 ea
YIN6704S*	1967-70	2 lines	with disc brakes	79.99 pr
YIN6703S	1971-72	1 line	all	79.99 ea
YIN7302S	1973	1 line	all	69.99 ea

1963-75 Stainless Steel Axle Brake Lines

YRA6502S	1963-66	2 lines	all	34.99 pr
YRA6701S	1967-69	2 lines	7-1/4" rear axle	34.99 pr
YRA6702S	1967-69	2 lines	8-3/4" rear axle	34.99 pr
YRA7001S	1970-72	2 lines	8-3/4" rear axle	34.99 pr
YRA7003S	1970-72	2 lines	7-1/4" rear axle	34.99 pr
YRA7301S	1973	2 lines	8-3/4" rear axle	34.99 pr
YRA7302S	1973	2 lines	9-1/4" rear axle	34.99 pr
YRA7303S	1973-75	2 lines	8-1/4" rear axle	34.99 pr
YRA7501S	1975	2 lines	Dart Swinger	34.99 pr

1 STEERING, SUSPENSION, REAR END & BRAKES

B-Body Brake Lines

Type 1 - 1966 model vehicles only
Right front line rises about 4-1/2" above the bell housing area of the firewall.

Type 2 - 1966 model vehicles only
Right front line runs fairly straight across firewall to right side.

Type 3 - 1967 model vehicles only
Right front line clips under the steering column, then rises about 4-1/2" above the bell housing area of the firewall.

Type 4 - 1967 model vehicles only
Right front line clips under the steering column, then runs fairly straight across firewall to right side.

Type 5 - 1967-70 model vehicles
Right front line clips to inner fender, rises about 4-1/2" above the bell housing area, then routes over the frame rail to the hose.

Type 6 - 1969-70 model vehicles
Right front line clips to inner fender, rises about 4-1/2" above the bell housing area, then routes under the frame rail to the hose.

Type 7 - 1969-70 disc brake models
Right front line clips to inner fender, rises about 4-1/2" above the bell housing area, then routes under the frame rail to the hose.

Over or Under the Frame?
Type 6 & 7 lines route under the frame, then back up to the flex hose on the passenger's side, while all the other lines route over the frame, through the splash guard.

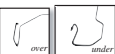

1962-74 B-Body Brake Line Sets

1962-74 OEM Material Front Brake Lines

*Note: *Refer to line type illustrations for application information.*

RKT6201R	1962-64	3 lines	max wedge	54.99	set
RKT6401R	1962-64	3 lines	std brakes, exc. max wedge	54.99	set
RKT6501R	1965	3 lines	standard brakes	54.99	set
RKT6502R	1965	3 lines	power brakes	54.99	set
RKT6601R	1966	3 lines	standard brakes, type 1	54.99	set
RKT6602R	1966	3 lines	power brakes, type 1	54.99	set
RKT6603R	1966	3 lines	standard brakes, type 2	54.99	set
RKT6604R	1966	3 lines	power brakes, type 2	54.99	set
RKT6605R	1966	3 lines	Hemi, pwr brakes, type 1	54.99	set
RKT6606R	1966	3 lines	Hemi, pwr brakes, type 2	54.99	set
RKT6701R	1967	4 lines	standard brakes, type 3	54.99	set
RKT6702R	1967	4 lines	standard brakes, type 4	54.99	set
RKT6703R	1967	4 lines	standard brakes, type 5	54.99	set
RKT6704R	1967	4 lines	power brakes, type 3	54.99	set
RKT6705R	1967	4 lines	power brakes, type 4	54.99	set
RKT6706R	1967	4 lines	power brakes, type 5	54.99	set
RKT6706R	1968-69	4 lines	Hemi, pwr brakes, type 3	54.99	set
RKT6801R	1969-70	4 lines	drum brakes, type 6	54.99	set
RKT6802R	1969-70	5 lines	Hemi, pwr disc brakes, type 7	54.99	set
RKT6803R	1969-70	5 lines	power disc brakes, type 7	54.99	set
RKT6804R	1968-70	4 lines	drum brakes, type 5	54.99	set
RKT6805R	1968-70	4 lines	pwr disc, left ported master, type 7	54.99	set
RKT6806R	1968-70	4 lines	pwr disc, left ported master, type 5	54.99	set
RKT6807R	1968-70	4 lines	Hemi, pwr drum brakes, type 5	54.99	set
RKT6808R	1969-70	4 lines	pwr disc, right ported master, type 5	54.99	set
RKT7101R	1971-72	4 lines	standard drum brakes	54.99	set
RKT7102R	1971	4 lines	power drum brakes	54.99	set
RKT7103R	1971	5 lines	power disc brakes	54.99	set
RKT7104R	1971	5 lines	Hemi, power disc brakes	54.99	set
RKT7201R	1972	4 lines	standard drum brakes	54.99	set
RKT7202R	1972	4 lines	power drum brakes	54.99	set
RKT7203R	1972	4 lines	power disc brakes	54.99	set
RKT7303R	1973	4 lines	power disc brakes	54.99	set
RKT7402R	1974	4 lines	power disc brakes	54.99	set

1962-74 OEM Material Front Brake Lines

*Note: *Refer to line type illustrations for application information.*

RKT6201S	1962-64	3 lines	max wedge	79.99	set
RKT6401S	1962-64	3 lines	std brakes, exc. max wedge	79.99	set
RKT6501S	1965	3 lines	standard brakes	79.99	set
RKT6502S	1965	3 lines	power brakes	79.99	set
RKT6601S	1966	3 lines	standard brakes, type 1	79.99	set
RKT6602S	1966	3 lines	power brakes, type 1	79.99	set
RKT6603S	1966	3 lines	standard brakes, type 2	79.99	set
RKT6604S	1966	3 lines	power brakes, type 2	79.99	set
RKT6605S	1966	3 lines	Hemi, pwr brakes, type 1	79.99	set
RKT6606S	1966	3 lines	Hemi, pwr brakes, type 2	79.99	set
RKT6701S	1967	4 lines	standard brakes, type 3	79.99	set
RKT6702S	1967	4 lines	standard brakes, type 4	79.99	set
RKT6703S	1967	4 lines	standard brakes, type 5	79.99	set
RKT6704S	1967	4 lines	power brakes, type 3	79.99	set
RKT6705S	1967	4 lines	power brakes, type 4	79.99	set
RKT6706S	1967	4 lines	power brakes, type 5	79.99	set
RKT6706S	1968-69	4 lines	Hemi, pwr brakes, type 5	79.99	set
RKT6801S	1969-70	4 lines	drum brakes, type 6	79.99	set
RKT6802S	1969-70	5 lines	Hemi, pwr disc brakes, type 7	79.99	set
RKT6803S	1969-70	5 lines	power disc brakes, type 7	79.99	set
RKT6804S	1968-70	4 lines	drum brakes, type 5	79.99	set
RKT6805S	1968-70	4 lines	pwr disc, left ported master, type 7	79.99	set
RKT6806S	1968-70	4 lines	pwr disc, left ported master, type 5	79.99	set
RKT6807S	1968-70	4 lines	Hemi, pwr drum brakes, type 5	79.99	set
RKT6808S	1969-70	4 lines	pwr disc, right ported master, type 5	79.99	set
RKT7101S	1971-72	4 lines	standard drum brakes	79.99	set
RKT7102S	1971	4 lines	power drum brakes	79.99	set
RKT7103S	1971	5 lines	power disc brakes	79.99	set
RKT7104S	1971	5 lines	Hemi, power disc brakes	79.99	set
RKT7201S	1972	4 lines	standard drum brakes	79.99	set
RKT7202S	1972	4 lines	power drum brakes	79.99	set
RKT7203S	1972	4 lines	power disc brakes	79.99	set
RKT7303S	1973	4 lines	power disc brakes	79.99	set
RKT7402S	1974	4 lines	power disc brakes	79.99	set

1962-74 OEM Material Front to Rear Brake Lines

*Important: *Requires part # MD2274 hold-off valve.*

Note: Shipped double oversize.

RIN6201R	1962-64	1 line	Dodge	54.99	ea
RIN6401R	1962-65	1 line	Plymouth	54.99	ea
RIN6301R	1963	1 line	Dodge wagon	54.99	ea
RIN6401R	1965	1 line	Dodge	54.99	ea
RIN6601R	1966	1 line	drum brakes	54.99	ea
RIN6602R	1966	3 lines	disc brakes	54.99	set
RIN6801R	1967-70	2 lines	disc only	54.99	pr
RIN6802R	1967-70	1 line	drum or disc, w/o prop valve	54.99	pr
RIN7101R	1971	1 line	drum or disc	54.99	ea
RIN7101R	1972	1 line	drum brakes only	54.99	ea
RIN7202R	1972	1 line	disc brakes only	54.99	ea
RIN7301R	1973-74	1 line	disc brakes only	54.99	ea

1962-74 OEM Material Front to Rear Brake Lines

*Important: *Requires part # MD2274 hold-off valve.*

Note: Shipped double oversize.

RIN6201S	1962-64	1 line	Dodge	79.99	ea
RIN6401S	1962-65	1 line	Plymouth	79.99	ea
RIN6301S	1963	1 line	Dodge wagon	79.99	ea
RIN6401S	1965	1 line	Dodge	79.99	ea
RIN6601S	1966	1 line	drum brakes	79.99	ea
RIN6602S	1966	3 lines	disc brakes	79.99	set
RIN6801S	1967-70	2 lines	disc only	79.99	pr
RIN6802S	1967-70	1 line	drum or disc, w/o prop valve	79.99	ea
RIN7101S	1971	1 line	drum or disc	79.99	ea
RIN7101S	1972	1 line	drum brakes only	79.99	ea
RIN7202S	1972	1 line	disc brakes only	79.99	ea
RIN7301S	1973-74	1 line	disc brakes only	79.99	ea

1962-74 OEM Material Rear Axle Brake Lines

Note: On 1966-69 axle housings, distribution block bolt was located close to the center section while 1970 & later bolt was located farther from the center section on the rear part of the axle tube. In case of rear axle swap, check bolt location before ordering lines.

RAA6401R	1962-65	2 lines	all vehicles	24.99	pr
RAA6601R	1966-67	2 lines	Dana rear axle	24.99	pr
RAA6801R	1966-69	2 lines	rear axle, 8-3/4" only	24.99	pr
RAA6802R	1968-69	2 lines	Dana rear axle	24.99	pr
RAA7001R	1970	2 lines	rear axle, 8-3/4" & Dana	24.99	pr
RAA7101R	1971-72	2 lines	8-3/4" rear axle	24.99	pr
RAA7102R	1971-72	2 lines	Dana rear axle	24.99	pr
RAA7301R	1973	2 lines	all vehicles	24.99	pr
RAA7401R	1974	2 lines	8-3/4" rear axle	24.99	pr

1962-74 Stainless Steel Rear Axle Brake Lines

Note: On 1966-69 axle housings, distribution block bolt was located close to the center section while 1970 & later bolt was located farther from the center section on the rear part of the axle tube. In case of rear axle swap, check bolt location before ordering lines.

RAA6401S	1962-65	2 lines	all vehicles	34.99	pr
RAA6601S	1966-67	2 lines	Dana rear axle	34.99	pr
RAA6801S	1966-69	2 lines	rear axle, 8-3/4" only	34.99	pr
RAA6802S	1968-69	2 lines	Dana rear axle	34.99	pr
RAA7001S	1970	2 lines	rear axle, 8-3/4" & Dana	34.99	pr
RAA7101S	1971-72	2 lines	8-3/4" rear axle	34.99	pr
RAA7102S	1971-72	2 lines	Dana rear axle	34.99	pr
RAA7301S	1973	2 lines	all vehicles	34.99	pr
RAA7401S	1974	2 lines	8-3/4" rear axle	34.99	pr

E-Body Brake Lines

1970-74 E-Body Brake Line Sets

Each line is manufactured using a precision process that produces the exact bends of the factory equipment lines. Each line set is clearly labeled for your convenience and pre-fitted for easy installation and is machine double-flared for a safe, no-leak fit. Applications are available for 1970-

74 E-Body vehicles in your choice of galvanized steel or never-rust stainless steel.

Note: Front to rear brake lines shipped double overcast.

Type 1 - Under Frame Rail
Right front line routed under the frame rail on all 1970 models and select 1971-74 model E-body vehicles.

Type 2 - Over Frame Rail
Right front line routed over the frame rail on certain 1971-74 model E-body vehicles.

New!



1970-74 OEM Material Front Brake Line Sets

Note: Refer to "line type" illustrations for application information.

Type 1 - Routed Under Frame Rail*

EKT7001R	1970-73	4 lines	standard drum brakes	59.99 set
EKT7002R	1970-73	4 lines	power drum brakes	59.99 set
EKT7003R	1970-71	5 lines	power disc brakes, w/o prop valve	59.99 set
EKT7004R	1970-71	5 lines	power disc brakes, w/prop valve	59.99 set
EKT7005R	1970-71	5 lines	Hemi, power disc, w/prop valve	59.99 set
EKT7202R	1972-73	4 lines	standard disc brakes	59.99 set
EKT7203R	1972-73	4 lines	power disc brakes	59.99 set
EKT7402R	1974	4 lines	standard disc brakes	59.99 set
EKT7403R	1974	4 lines	power disc brakes	59.99 set
Type 2 - Routed Over Frame Rail*				
EKT7101R	1971-73	4 lines	standard drum brakes	59.99 set
EKT7102R	1971-73	4 lines	power drum brakes	59.99 set
EKT7103R	1971	5 lines	power disc brakes, w/o prop valve	59.99 set
EKT7105R	1971	5 lines	Hemi, power disc, w/o prop valve	59.99 set
EKT7204R	1972-73	4 lines	standard disc brakes	59.99 set
EKT7205R	1972-73	4 lines	power disc brakes	59.99 set
EKT7404R	1974	4 lines	standard disc brakes	59.99 set
EKT7405R	1974	4 lines	power disc brakes	59.99 set

1970-74 OEM Material Front to Rear Brake Lines

				433
EIN7003R	1970-74	1 line	drum brakes	54.99 ea
EIN7003R	1970-71	1 line	disc brakes w/o prop valve	54.99 ea
EIN7004R	1970-71	2 lines	disc brakes w/prop valve	54.99 pr
EIN7201R	1972-74	1 line	disc brakes	54.99 ea
Challenger				
EIN7007R	1970-74	1 line	drum brakes	54.99 ea
EIN7007R	1970-71	1 line	disc brakes w/o prop valve	54.99 ea
EIN7008R	1970-71	2 lines	disc brakes w/prop valve	54.99 pr
EIN7202R	1972-74	1 line	disc brakes	54.99 ea

1970-74 OEM Material Rear Axle Brake Lines

ERA7001R	1970-73	2 lines	8-3/4" or Dana rear axle	29.99 pr
ERA7401R	1974	2 lines	8-3/4" rear axle	31.99 pr

1970-74 Stainless Steel Front Brake Line Sets

Note: Refer to "line type" illustrations for application information.

Type 1 - Routed Under Frame Rail*

EKT7001S	1970-73	4 lines	standard drum brakes	84.99 set
EKT7002S	1970-73	4 lines	power drum brakes	84.99 set
EKT7003S	1970-71	5 lines	power disc brakes, w/o prop valve	84.99 set
EKT7004S	1970-71	5 lines	power disc brakes, w/prop valve	84.99 set
EKT7005S	1970-71	5 lines	Hemi, power disc, w/prop valve	84.99 set
EKT7202S	1972-73	4 lines	standard disc brakes	84.99 set
EKT7203S	1972-73	4 lines	power disc brakes	84.99 set
EKT7402S	1974	4 lines	standard disc brakes	84.99 set
EKT7403S	1974	4 lines	power disc brakes	84.99 set
Type 2 - Routed Over Frame Rail*				
EKT7101S	1971-73	4 lines	standard drum brakes	84.99 set
EKT7102S	1971-73	4 lines	power drum brakes	84.99 set
EKT7103S	1971	5 lines	power disc brakes, w/o prop valve	84.99 set
EKT7105S	1971	5 lines	Hemi, power disc, w/o prop valve	84.99 set
EKT7204S	1972-73	4 lines	standard disc brakes	84.99 set
EKT7205S	1972-73	4 lines	power disc brakes	84.99 set
EKT7404S	1974	4 lines	standard disc brakes	84.99 set
EKT7405S	1974	4 lines	power disc brakes	84.99 set

1970-74 Stainless Steel Front to Rear Brake Lines

				433
EIN7003S	1970-74	1 line	drum brakes	79.99 ea
EIN7003S	1970-71	1 line	disc brakes w/o prop valve	79.99 ea
EIN7004S	1970-71	2 lines	disc brakes w/prop valve	79.99 pr
EIN7201S	1972-74	1 line	disc brakes	79.99 ea
Challenger				
EIN7007S	1970-74	1 line	drum brakes	79.99 ea
EIN7007S	1970-71	1 line	disc brakes w/o prop valve	79.99 ea
EIN7008S	1970-71	2 lines	disc brakes w/prop valve	79.99 pr
EIN7202S	1972-74	1 line	disc brakes	79.99 ea

1970-74 Stainless Steel Rear Axle Brake Lines

ERA7001S	1970-73	2 lines	8-3/4" or Dana rear axle	39.99 pr
ERA7401S	1974	2 lines	8-3/4" rear axle	39.99 pr

1966-69 Front Disc Brake Hose Bracket

Reproduction front disc brake hose bracket for 1966-69 B-Body models. Brackets are manufactured from correct gauge steel and include two brake hose clips and are mounted to the inboard side of the calipers.
MN8049 1966-69 w/disc brakes..... 44.99 set

New!



1971-74 Rear Axle Hose Brackets

Reproduction rear axle brake hose brackets for 1971-74 B and E-Body models. These brackets secure the rear axle hose to the body and are manufactured from correct gauge steel. Includes the correct brake hose clip and 6/16-18 hex con SEMS bolt.
MN8053 1971-74 B-Body..... 15.99 set
MN8054 1971-74 E-Body..... 15.99 set



Brake Line Fittings

Wilwood's brake line fittings are manufactured to high quality standards and are available in various sizes and configurations.

Note: No further discounts apply.



Caliper Fitting

3 Male to 1/8"-27 NPT Male	
2206410 straight	8.99 ea
2206412 45°	19.99 ea
22013125 90°	9.99 ea

Frame Fitting

24 Inverted Flare to -3 Male	
2206410 3/8"	9.99 ea
2206457 7/16"	9.99 ea
1/0 Bubble Flare to -3 Male	
2206890 10 mm	19.99 ea
2206413 10 mm	9.99 ea

Adapter

24 Female IF to 1/8"-27 NPT Male	
2200628 3/8" - 4 piece set	7.99 set

New!



1970-74 B/E-Body Brake/Fuel Line Shields

Reproduction brake/fuel line shields for 1971-72 B-Body and 1970-74 E-Body models. The shields protect the lines from stone and road debris damage. These shields are mounted near the front lead spring perches on both sides of the car. Sold in pairs.
MP500513 1971-72 B-Body..... 34.99 pr
MP500513 1970-74 E-Body..... 34.99 pr

Brake Line Components



1962-76 Replacement Flexible Brake Hoses

Replacement brake line flexible hoses for 1962-76 Mopar A-Body, B-Body and E-Body vehicles. Available in either OEM material or braided stainless steel. OEM Material hoses feature single crimp/wage fitting on each end and black nylon jacket. Stainless braided hoses feature correct fittings on each end and clear coating on hose. Banjo bolts and copper washers included when applicable. D.O.T. approved.

Note: *May require tie block MN1156. **May require tie block MN1155.

1963-76 A-Body Flexible Brake Hoses

OEM Material Flexible Brake Hoses

Front			
MA2218	1963-66	w/9" drum brakes	9.99 ea
MD7047	1965-69	w/10" drum brakes	19.99 ea
MA2219	1967-69	w/9" drum brakes	14.99 ea
MA2220	1970-72	all vehicles	19.99 ea
MA2221	1973-76	disc brakes	19.99 ea
Rear			
MA2222	1963-69	all vehicles	21.99 ea
MD7048	1970-71	all vehicles	19.99 ea
MD7049	1972-76	all vehicles	15.99 ea

Braided Stainless Flexible Brake Hoses

Front			
MA2218S	1963-66	w/9" drum brakes	24.99 ea
MD7047S	1965-69	w/10" drum brakes	24.99 ea
MA2220S	1970-72	all vehicles	24.99 ea
MA2221S	1973-76	disc brakes	29.99 ea
Rear			
MA2222S	1965-69	all vehicles	29.99 ea
MD7048S	1970-71	all vehicles	29.99 ea
MD7049S	1972-76	all vehicles	49.99 ea

1962-76 B-Body Flexible Brake Hoses

OEM Material Flexible Brake Hoses

Front			
MD7047	1962-69	drum brakes	19.99 ea
MB2244	1966-69	disc brakes	21.99 ea
MD7050	1970-72	drum brakes	19.99 ea
MD7051	1970-72	disc brakes	12.99 ea
MA2221	1973-76	front disc flex hose	19.99 ea
Rear			
MB2246	1962-65	all vehicles	19.99 ea
MB2247*	1966-69	8-3/4" rear axle	19.99 ea
MB2248**	1966-69	Dana rear axle	19.99 ea
MB2249**	1970-71	all vehicles	21.99 ea
MD7049	1972-76	all vehicles	15.99 ea

Braided Stainless Flexible Brake Hoses

Front			
MD7047S	1962-69	drum brakes	24.99 ea
MD7050S	1970-72	drum brakes	24.99 ea
MD7051S	1970-72	disc brakes	27.99 ea
MA2221S	1973-76	front disc flex hose	29.99 ea
Rear			
MB2246S	1962-65	all vehicles	24.99 ea
MB2247S*	1966-69	8-3/4" rear axle	24.99 ea
MB2248S**	1966-69	Dana rear axle	29.99 ea
MB2249S**	1970-71	all vehicles	39.99 ea
MD7049S	1972-76	all vehicles	49.99 ea

1970-74 E-Body Flexible Brake Hoses

OEM Material Flexible Brake Hoses

Front			
MD7050	1970-72	drum brakes	19.99 ea
MD7051	1970-73	disc brakes	12.99 ea
ME1619	1974	front disc brakes	24.99 ea
Rear			
ME1620	1970	w/block	21.99 ea
MD7048	1970-71	w/o block	19.99 ea
MD7049	1972-74	all vehicles	15.99 ea

Braided Stainless Flexible Brake Hoses

Front			
MD7050S	1970-72	drum brakes	24.99 ea
MD7051S	1970-73	disc brakes	27.99 ea
Rear			
ME1620S	1970	w/block	38.99 ea
MD7048S	1970-71	w/o block	29.99 ea
MD7049S	1972-74	all vehicles	49.99 ea

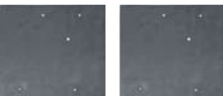

1962-65 Brake Line Splash Shield

Brake line splash shields for 1962-65 B-Body models. MB2214 1962-65 B-Body 14.99 pr



Brake Line Hose Bolts

Specialy drilled bolt that secures the brake line to the caliper. Set includes 2 bolts and 4 washers. 393705 10mm various models 19.99 set
393706 7/16"-20 1973-76 models 20.99 set



Brake Line Brackets

These brackets and clips will mount rubber, nylon or stainless steel lines to the suspension or frame. Bolt-on or weld-on for easy installation.

393737 19.99 set



Bleeder Screw Dust Caps

These dust caps are installed in seconds on your brake bleeder screws to keep road debris and the elements from plugging the orifice.

KW561 5.99 pr



MD4722

1963-75 Brake Line Clip Sets

Reproduction brake line clip sets for 1963-75 A, B, and E-Body models. Includes correct reproduction clips and bolts to attach brake lines to the frame. If your brake line clips are missing or damaged, now is the time to purchase a reproduction set to complete the job.

A-Body

MD4720	1963-65	6 piece	13.99 set
MD4721	1966	6 piece	13.99 set
MD4722	1967-75	12 piece	14.99 set

B-Body

MD4723	1963-65	7 piece	14.99 set
MD4722	1966-70	12 piece	14.99 set
MD4724	1971-74	11 piece	14.99 set

E-Body

MD4724	1971-74	11 piece	14.99 set
--------	---------	----------	-----------



One-Man Brake Bleeder

Loosen the bleeder screw and fill with brake fluid. Pump the brakes until the hose is free of bubbles. Everything is included to quickly bleed brakes with no mess. Plastic bottle collects discharged fluids. Complete instructions included. Y19200 one-man brake bleeder 11.99 set

Disc Brake Components

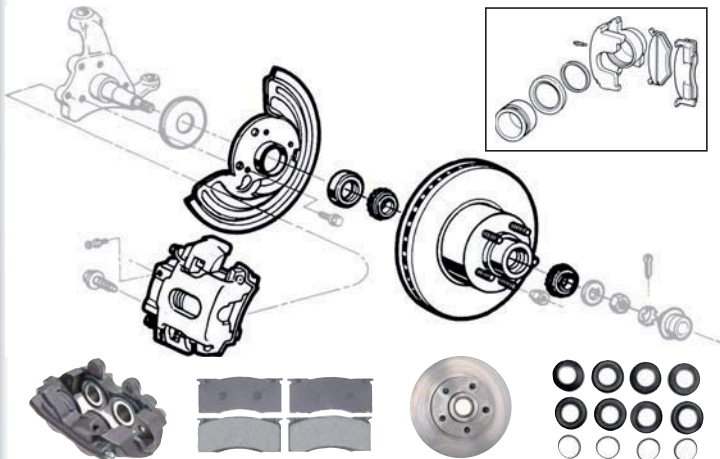

FRC4176 Disc Brake Caliper

PGD11 - Disc Brake Pads

7032R - Front Brake Rotor

MN8043 - Caliper Seal Kit

1965-75 Front Disc Brake Calipers

These Centric calipers allow you to set up your brakes with the best pads for your application. Each fully assembled caliper is 100% pressure tested to ensure safe, leak-free performance. Just install the pads you want for your driving conditions! Includes hardware and mounting brackets.

A-Body		B-Body		E-Body	
MN8045	1965-72 LH	4-piston	all models	169.99	ea
MN8009	1965-72 RH	4-piston	all models	169.99	ea
MN8003	1973-75 LH	1-piston	all models	109.99	ea
MN8004	1973-75 RH	1-piston	all models	109.99	ea
MN8007	1976 LH	1-piston	all models	31.99	ea
MN8008	1976 RH	1-piston	all models	31.99	ea
B-Body					
MN8001	1970-72 LH	1-piston	all models	89.99	ea
MN8002	1970-72 RH	1-piston	all models	89.99	ea
MN8003	1974 LH	1-piston	Satellite with 360	109.99	ea
MN8004	1974 RH	1-piston	Satellite with 360	109.99	ea
FRC4097	1973-74 RH	1-piston	all exc. Satellite 360	39.99	ea
MN8003	1973-75 LH	1-piston	Charger, w/slider clpr	109.99	ea
MN8004	1973-75 RH	1-piston	Charger, w/slider clpr	109.99	ea
E-Body					
MN8001	1970-74 LH	1-piston	all	89.99	ea
MN8002	1970-74 RH	1-piston	all	89.99	ea

1965-74 Front Brake Pads

Our disc brake pads are the most complete line of premium quality brakes in the industry. Engineered to provide the best overall performance for everyday driving conditions, these pads offer vehicle specific formulations to assure safe and consistent stopping power. Certified to meet Federal Safety Standards.

MN8046	1965-72	all A-Body	24.99	set
MN8058	1966-69	all B-Body, molded pads	16.99	set
MN8031	1970-74	all B-Body, molded pads	16.99	set
MN8031	1970-74	all E-Body, molded pads	16.99	set

1970-76 Front Rotors

Centric Industries' rotors offer the best coverage in the industry—ensuring you will always have access to the parts you need when you need them. The vane configurations of these rotors are designed for optimal cooling and each rotor features an applied non-directional finish to remove peaks and directional lines which can cause noise and brake roughness.

A-Body		B-Body		E-Body	
7032R	1973-76	all models	39.99	ea	
7008R	1970-72	all models	64.99	ea	
7032R	1973-74	all models	39.99	ea	
7008R	1970-72	all models	64.99	ea	
7032R	1973-76	all models	39.99	ea	

1965-74 Caliper Seal Kits

Rebuild your brake calipers with high quality caliper seal kits. Each seal kit contains components to resal 1 caliper. 1 kit per caliper required.

A-Body		B-Body		E-Body	
MN8043	1965-69	Barracuda	9.99	set	
MN8043	1965-72	Dart	9.99	set	
MN8043	1965-72	Valiant	9.99	set	
MN8043	1968-69	Dart GTS	9.99	set	
MN8043	1970-72	Duster	9.99	set	
MN8043	1971	Dart Swinger	9.99	set	
MN8043	1971-72	Scamp	9.99	set	
B-Body					
MN8044	1969-70	Coronet	2.99	kit	
MN8044	1969-71	GTX	2.99	kit	
MN8044	1970-73	Satellite	2.99	kit	
MN8044	1970-74	Charger	2.99	kit	
E-Body					
MN8044	1970-74	all	2.99	kit	

STEERING, SUSPENSION, REAR END & BRAKES

Disc Brake Components

SSBC
STOCKING MOTOR VEHICLES



A189R



A1991R

1965-72 A-Body Disc Brake Calipers

Aluminum brake caliper set for 1965-72 A-Body models. Designed for 14" x 7" wheels, these sets include 43mm 4-piston aluminum calipers and high performance brake pads. Calipers available in clear anodized finish, red or black powder coated finish, or polished aluminum finish. These sets are replacements for models with OE Kelsey Hayes 4-piston calipers. Competition Street calipers save 14 lbs. unsprung weight.

Note: These sets must be used with stock size rotors.

Kelsey Hayes Style Calipers

A189 1965-72 clear anodized 659.99 set
A189BK 1965-72 black powder coated 739.99 set
A189R 1965-72 red powder coated..... 739.99 set

Competition Street Calipers

A1991 1965-72 clear anodized 429.99 set
A1991BK 1965-72 black powder coated 534.99 set
A1991R 1965-72 red powder coated..... 465.99 set
A1991P 1965-72 polished 564.99 set

SSBC
STOCKING MOTOR VEHICLES



BIG BITE
Cross Drilled Rotors

1973-76 Big Bite Drilled Front Rotors

The CNC-drilled holes in these rotors vent superheated gases to reduce brake fade, while the precision turbo slotting maintains a clean pad surface, maximum grip and quiet stopping power. Internal vanes promote cooling and help prevent warping by forcing air through the rotor. These Big Bite Cross Drilled Rotors are an ideal replacement for stock rotors.

23109 1973-76 A-Body 224.99 pr
23109 1973-75 B-Body 224.99 pr
23109 1973-74 E-Body 224.99 pr

SSBC
STOCKING MOTOR VEHICLES



1600841

1973-76 Big Bite Brake Pads

These brake pads feature a specially formulated compound to deliver increased stopping power while reducing noise and brake dust. The fully slotted and chamfered design and nitrile-Polymer coated hardware are designed for maximum noise suppression. Compatible with O.E. calipers and rotors.

1600841 1973-76 A-Body 61.99 set
1600391 1971-75 B-Body 62.99 set
1600391 1970-74 E-Body 62.99 set



Y25750

Speedy Brake Pad Spreader

The pistol grip ratcheting action and fast acting plunger compresses disc brake pistons in seconds. This makes brake pad replacement a snap.

Y24300 single piston 49.99 ea
Y25750 dual piston 57.99 ea

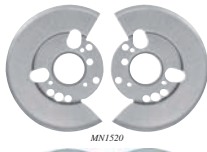

MNI1520



MNI121

1966-74 B & E-Body Splash Shields

These stamped steel disc brake splash shields for 1966-74 B and E-body models are designed to fit and function as original.

Note: Models with 4-piston disc brakes.

B-Body

MB184503* 1966-69 129.99 pr
MNI1520 1970-72 109.99 pr
MNI1521 1973-74 52.99 pr

E-Body

MNI1520 1970-72 109.99 pr
MNI1521 1973-74 52.99 pr

Lisle



Universal Bearing Grease

Special tool designed to pack the bearings so they stay where they belong. Works on most cars and trucks.
Y62520 11.99 ea



High Temp Wheel Bearing Grease

When replacing or just repacking your wheel bearings, don't use ordinary grease. Protect those bearings with a high quality, high temperature bearing grease. This is a very stable aluminumized complex thickened grease used for the lubrication of wheel bearings, chassis ball joints and other bearing applications operating under severe conditions. This product assures high temperature protection from excessive heat generated by disc brakes.

SL3161 bearing grease, 14 oz. can 5.99 ea



MR5000

1960-76 Wheel Bearing and Seal Kit

Quit searching for all the individual components you need when replacing your worn out wheel bearings and seals. Buy the kit to save time and money! Our wheel bearing and seal kit includes two outer wheel bearings with races and two wheel seals.

A-Body

Dodge
MR5000 1960-61 Lancer 44.99 kit
MR5001 1962 Lancer 44.99 kit
MR5002 1963-72 with 9" brakes 44.99 kit
MR5000 1965-72 with 10" brakes 44.99 kit
MR5001 1970-72 with 11" brakes 44.99 kit
MR5003 1973-76 with drum brakes..... 43.99 kit
MR5004 1973-76 with disc brakes..... 43.99 kit

Plymouth

MR5002 1960-72 with 9" brakes 44.99 kit
MR5000 1965-72 with 10" brakes 44.99 kit
MR5001 1970-72 with 11" brakes 44.99 kit
MR5003 1973-76 with drum brakes..... 43.99 kit
MR5004 1973-76 with disc brakes..... 43.99 kit

B-Body

MR5000 1960-61 all 44.99 kit
MR5001 1962-66 all 44.99 kit
MR5000 1967-72 with 10" brakes 44.99 kit
MR5001 1967-72 with 11" brakes 44.99 kit
MR5004 1973-76 all 43.99 kit

E-Body

MR5000 1970-72 with 10" brakes 44.99 kit
MR5001 1970-72 with 11" brakes 44.99 kit
MR5004 1973-74 all 43.99 kit

Drum Brake Components



CB2065



1960-76 Drum Brake Shoes

These professional quality replacement brake shoes are designed to maximize the capability of drum brake systems, providing the best overall performance for everyday driving conditions. To further improve the stopping performance of your drum brakes, combine these shoes with our complete line of professional quality replacement brake drums.

Note: *Coronet wagon with round spring adjustment hole.

Note: Except Coronet wagon with round spring adjustment hole.

9" x 2-1/2" Front Brake Shoes

A-Body			
CB2002	1960-68	all.....	24.99 set
CB2060	1969-73	all.....	24.99 set

10" x 2-1/4" Front Brake Shoes

A-Body			
CB2062	1965-69	Barracuda.....	29.99 set
CB2062	1969-72	all.....	29.99 set

10" x 2-1/2" Front Brake Shoes

A-Body			
CB2063	1973-75	all.....	24.99 set

B-Body			
CB2008	1962-68	Dart.....	24.99 set
CB2008*	1969	Coronet wagon.....	24.99 set
CB2063	1969-72	all.....	24.99 set

E-Body			
CB2063	1970-72	all.....	24.99 set

B-Body			
CB2065	1965-72	all.....	39.99 set

E-Body			
CB2065	1970-71	Barracuda.....	39.99 set
CB2065	1970-72	Challenger.....	39.99 set

9" x 2" Rear Brake Shoes

A-Body			
CB2003	1960-68	all.....	24.99 set

10" x 1-3/4" Rear Brake Shoes

A-Body			
CB2061	1967-72	Dart.....	29.99 set
CB2061	1968-69	Dart GTS.....	29.99 set
CB2061	1969	Barracuda.....	29.99 set
CB2061	1969-74	Valiant.....	29.99 set
CB2061	1970-72	Duster.....	29.99 set
CB2061	1971-72	Scamp.....	29.99 set

B-Body			
CB2061	1969	all.....	29.99 set

10" x 2-1/2" Rear Brake Shoes

B-Body			
CB2008	1962-68	all.....	24.99 set
CB2008*	1969	Coronet wagon.....	24.99 set

E-Body			
CB2063	1973-75	all.....	24.99 set

B-Body			
CB2063**	1969-74	all.....	24.99 set

E-Body			
CB2063	1970-72	all.....	24.99 set

B-Body			
CB2064	1962-74	all.....	34.99 set

E-Body			
CB2064	1970-72	all.....	34.99 set

11" x 2-1/2" Rear Brake Shoes



1962-74 Drum Brake Hardware Sets

Completely replace worn-out or missing brake components and bring your drum brakes back to proper, safe working condition. Front or rear sets contain springs, clips, and hardware necessary to attach brake shoes and braking mechanism to backing plates.

A-Body			
MN8023	1963-68	front or rear with 9".....	11.99 set
MN8027	1969-74	front or rear with 9".....	6.99 set
MN8026	1969-74	front or rear with 10".....	7.99 set

B-Body			
MN8023	1967-68	Satellite front w/9".....	11.99 set
MN8027	1973-74	Satellite front with 9".....	6.99 set
MN8026	1969-74	front or rear with 10".....	7.99 set
Mn8025	1962-64	rear with 11" x 3".....	7.99 set
H7105	1962-64	rear with 11" x 2".....	9.99 set
MN8025	1962-69	front with 11".....	7.99 set
MN8025	1969	Coronet (Early model) front with 11".....	7.99 set
MN8025	1969	Coronet (Late model) front with 11".....	7.99 set
MN8029	1969-72	Charger rear with 11".....	6.99 set
MN8028	1969-74	front or rear with 11".....	7.99 set

E-Body			
MN8028	1970-72	front or rear with 11".....	7.99 set
MN8026	1970-74	front or rear with 10".....	7.99 set



WC34178



MN8033

1960-76 Drum Brake Wheel Cylinders

Our wheel cylinders match the design of your vehicle's original equipment. They are built for long service life and feature the highest quality components for superior resistance to heat, corrosion and leakage. Wheel cylinders deliver consistent, safe and reliable performance. With Classic Industries® you get premium products designed to fit exact applications to perform as good as your original brakes.

Note: 2 rear wheel cylinders are required on each vehicle.

**Belvedere models with front disc brakes*

A-Body			
Front Wheel Cylinders			
With 9" Drum Brake			
WC34177	1960-66	LH.....	14.99 ea
WC34178	1960-66	RH.....	14.99 ea
MN8033	1967-72	RH.....	15.99 ea
MN8034	1967-72	LH.....	15.99 ea
WC37269	1973-74	LH.....	27.99 ea
WC37270	1973-74	RH.....	27.99 ea

B-Body			
Front Wheel Cylinders			
With 10" Drum Brake			
WC36050	1962-69	LH.....	11.99 ea
WC36051	1962-69	RH.....	11.99 ea
MN8035	1970-72	RH.....	14.99 ea
MN8036	1970-72	LH.....	14.99 ea

E-Body			
Front Wheel Cylinders			
With 10" or 11" Drum Brake			
MN8035	1970-74	RH.....	14.99 ea
MN8036	1970-74	LH.....	14.99 ea

B-Body			
Rear Wheel Cylinders			
With 9" Drum Brake			
WC34876	1965-69	6.99 ea
MN8038	1965-69	6.99 ea
MN8038	1970-74	6.99 ea
With 11" Drum Brake			
MN8038	1970-74	6.99 ea

STEERING, SUSPENSION, REAR END & BRAKES

Drum Brake Components



New!



2940



2940



1980



2947

1960-76 Replacement Brake Drums

Our professional quality brake drums offer the most complete line of premium, high-quality drums on the market. These vehicle-specific drums provide consistent quality, strength, performance and reduced noise.

Front Drums - 9"

A-Body - w/5 x 4" Bolt pattern

2940	1963-69	all	24.99 ea
2956	1970-71	all with finned drums	34.99 ea
1960	1973	Dart	109.99 ea
1960	1973-76	Plymouth models	109.99 ea

Front Drums - 10"

A-Body - w/5 x 4" Bolt pattern

2932	1965-72	Dart	29.99 ea
2932	1965-72	Valiant/Scamp	29.99 ea
2932	1970-72	Duster	29.99 ea
1980	1973-76	all	89.99 ea

B-Body

2915	1962-68	all with composite drum	34.99 ea
1926	1966-70	all with cast iron drum	34.99 ea
1926	1970	all with cast iron drum	34.99 ea

Front Drums - 11"

B-Body

1938	1966-70	all	49.99 ea
1952	1971-72	all with drums marked "MW"	124.99 ea

E-Body

1938	1970	all	49.99 ea
1952	1971-72	all with drums marked "MW"	124.99 ea

Rear Drums - 9"

A-Body - w/Front Drum Brakes

2941	1960-76	all	21.99 ea
------	---------	-----	----------

Rear Drums - 10"

A-Body - w/Front Disc Brakes

MN8000	1973-74	Dart	39.99 ea
2947	1973-76	Valiant	34.99 ea

B-Body

2915	1964	all with composite drum	34.99 ea
2947	1965-70	all	34.99 ea

E-Body

2947	1965-70	all	34.99 ea
------	---------	-----	----------

Rear Drums - 11"

2953	1970	all	44.99 ea
------	------	-----	----------

E-Body

2953	1970-72	Challenger	44.99 ea
2953	1970-74	Cuda	44.99 ea



MN431001



MN431007

1965-76 Parking Brake Strut/Actuator Levers

Reproduction parking brake strut levers for 1965-76 A, B, and E-Body models with 10" or 11" rear brake drums. Each set includes parking brake levers and two springs. Right side strut is stamped with an "R" when applicable. If you're doing a brake job, now is the time to replace your parking brake strut levers.

Brake Strut Levers

10" Brakes			
MN431001	1965-72	A-Body	27.99 set
MN431003	1973-76	A-Body	27.99 set
MN431003	1965-72	B-Body	27.99 set
MN431003	1970-74	E-Body	27.99 set
11" Brakes			
MN431002	1965-70	all	27.99 set
MN431004	1971-75	all	27.99 set

Brake Actuator Levers

Quality reproduction parking brake actuator levers for 10" and 11" rear drum brake applications. Each set includes pressed-in pivot pins, two zinc-plated C-clips, and two zinc-plated wave washers. Manufactured from correct gauge steel and embossed with original details.

10" Brakes

MN431006	1968-75	A-Body	49.99 set
MN431006	1968-75	B-Body	49.99 set
MN431006	1970-74	E-Body	49.99 set

11" Brakes

MN431007	1964-71	B-Body	49.99 set
MN431007	1970-71	E-Body	49.99 set



MN8019

1965-76 Drum Brake Self-Adjuster Hardware Sets

These self-adjuster hardware sets complement the brake hardware sets. Includes necessary hardware to repair one brake. Works with all drum brakes. Available for left and right side.

MN8013	1965-68	9" brakes	LH	9.99 set
MN8014	1965-68	9" brakes	RH	9.99 set
MN8015	1969-76	9" brakes	LH	9.99 set
MN8016	1969-76	9" brakes	RH	9.99 set
MN8017	1969-76	10" brakes	LH	9.99 set
MN8018	1969-76	10" brakes	RH	9.99 set

B-Body Models

MN8011	1965-69	10" brakes	LH	9.99 set
MN8012	1965-69	10" brakes	RH	9.99 set
MN8017	1970-76	10" brakes	LH	9.99 set
MN8018	1970-76	10" brakes	RH	9.99 set
MN8021	1965-69	11" brakes	LH	9.99 set
MN8022	1965-69	11" brakes	RH	9.99 set
MN8019	1970-76	11" brakes	LH	9.99 set

E-Body Models

MN8017	1970	10" brakes	LH	9.99 set
MN8018	1970	10" brakes	RH	9.99 set
MN8017	1973-74	10" brakes	LH	9.99 set
MN8018	1973-74	10" brakes	RH	9.99 set
MN8019	1971-72	11" brakes	LH	9.99 set

Wheels & Accessories

O.E. Steel Wheels

Original equipment style steel wheels for Mopar A-Body, B-Body and E-Body models. Manufactured to accept any dog dish style hub cap. Wheels feature correct black satin finish and are available in a variety of sizes for vehicles with 5 x 4" or 5 x 4-1/2" bolt pattern. Satin black powder coat finish. Valve stem is not included.

Note: Shipped overweight.



MW855

5 x 4" Bolt Pattern

Item#	Size	Backspacing	Description	Price
MW855	15" x 7"	4"	steel wheel	111.99 ea
MW856	15" x 8"	4"	steel wheel	111.99 ea
MW857	15" x 8"	4-1/2"	steel wheel	111.99 ea
MW858	15" x 10"	5-1/2"	steel wheel	169.99 ea

5 x 4-1/2" Bolt Pattern

Item#	Size	Backspacing	Description	Price
MW859	15" x 7"	4"	steel wheel	111.99 ea
MW860	15" x 8"	4"	steel wheel	111.99 ea
MW861	15" x 8"	4-1/2"	steel wheel	111.99 ea
MW862	15" x 10"	5-1/2"	steel wheel	169.99 ea



1967-68 Magnum 500 Wheel

Offered by Chrysler as well as other car lines, the Magnum 500 is the all time favorite OEM style wheel in the muscle car world. These replacement Magnum 500s are for most 1967-68 Dodge and Plymouth models. Features the correctly chromed plated face with black painted slots, will work with original, or replacement center caps. This wheel does not include center cap, lug nuts and will only fit vehicles with the 5 x 4-1/2" bolt pattern.

Note: Shipped overweight.



5 x 4-1/2" Bolt Pattern

Item#	Size	Backspacing	Description	Price
MW863	14" x 6"	4"	Magnum 500 wheel	172.99 ea
MW903	14" x 7"	4-1/4"	Magnum 500 wheel	164.99 ea
MW904	14" x 8"	4-1/2"	Magnum 500 wheel	169.99 ea
MW864	15" x 7"	4-1/4"	Magnum 500 wheel	175.99 ea
MW865	15" x 8"	4-1/2"	Magnum 500 wheel	179.99 ea
MW905	15" x 10"	5"	Magnum 500 wheel	259.99 ea
MW906	15" x 10"	5-1/2"	Magnum 500 wheel	259.99 ea



Billet Magnum 500 Wheels

Give your classic Mopar a complete new look with Billet Rallye wheels. Billet wheels are manufactured from two solid billet aluminum blocks, which are CNC machined for lightweight performance and classic styling. Then the hoop and center are assembled to the predetermined backspacing and welded. This wheel is modeled after the original Magnum 500 with a slight difference on the face of the wheel, which is fully polished with painted slots and sits more flush with the center line of the wheel. Does not include lug nuts and will only fit on vehicles with the 5" x 4-1/2" lug pattern.

Note: Shipped overweight.

5 x 4-1/2" Bolt Pattern

Item#	Size	Backspacing	Description	Price
MW802	15" x 7"	4-1/2"	Billet Magnum 500	579.99 ea
MW803	15" x 8"	4-1/2"	Billet Magnum 500	579.99 ea
MW804	15" x 10"	5"	Billet Magnum 500	579.99 ea
MW805	17" x 7"	5-1/2"	Billet Magnum 500	519.99 ea
MW806	17" x 8"	4-1/2"	Billet Magnum 500	549.99 ea
MW807	17" x 9.5"	5"	Billet Magnum 500	559.99 ea
MW808	17" x 9.5"	5-1/2"	Billet Magnum 500	559.99 ea
MW809	17" x 11"	5-1/2"	Billet Magnum 500	569.99 ea
MW810	18" x 7"	4-1/2"	Billet Magnum 500	569.99 ea
MW811	18" x 8"	4-1/2"	Billet Magnum 500	579.99 ea
MW812	18" x 9.5"	5"	Billet Magnum 500	579.99 ea
MW813	18" x 9.5"	5-1/2"	Billet Magnum 500	579.99 ea



Magnum Wheel Center Cap Set

Replacement center cap assemblies for Magnum and Road Wheels. Each cap features correct chrome finish and correct patterned center. Each set of caps includes all necessary mounting hardware.

MD2307 Magnum wheel center cap set..... 109.99 set



1969-74 Dog Dish Hub Cap Sets

Dog dish hub caps for various 1969-74 B & E-Body models. Caps feature correct recessed patterns as originals and will work on original wheels or replacement wheels. Sold as a set of four.

MD2309 Plymouth Plymouth Division lettering..... 244.99 set

New!



Plain Mopar Dog Dish Hubcaps

Reproduction dog dish hub caps for various 1969-74 B & E-body models. These caps feature correct recessed patterns and are designed for both original style wheels and replacement wheels. Available individually or in a four-piece set.

MP50600 1969-74 B & E-body 29.99 ea

MP50606A 1969-74 set of 4 99.99 kit

STEERING, SUSPENSION, REAR END & BRAKES

Wheels & Accessories



Chrome

Silver

Rallye Wheels

Rallye wheels for various Dodge and Plymouth models. Manufactured using steel, each features original style silver or chrome plated finish. Trim ring, lug nuts and center cap are not included. Available in 14" or 15" diameters and for both 5 x 4" and 5 x 4-1/2" lug pattern vehicles.

Note: Shipped overweight.

5 x 4" Bolt Pattern

Item#	Size	Backspacing	Finish	Price
MW831	14" x 6"	4"	chrome	149.99 ea
MW832	14" x 6"	4"	silver	109.99 ea
MW833	14" x 7"	4-1/4"	chrome	159.99 ea
MW834	14" x 7"	4-1/4"	silver	109.99 ea
MW835	14" x 8"	4-5/8"	chrome	159.99 ea
MW836	14" x 8"	4-5/8"	silver	121.99 ea
MW837	15" x 7"	4-1/4"	chrome	149.99 ea
MW838	15" x 7"	4-1/4"	silver	119.99 ea
MW839	15" x 8"	4-5/8"	chrome	159.99 ea
MW840	15" x 8"	4-5/8"	silver	124.99 ea

5 x 4-1/2" Bolt Pattern

Item#	Size	Backspacing	Finish	Price
MW841	14" x 6"	4"	chrome	144.99 ea
MW842	14" x 6"	4"	silver	109.99 ea
MW843	14" x 7"	4-1/4"	chrome	144.99 ea
MW844	14" x 7"	4-1/4"	silver	109.99 ea
MW845	14" x 8"	4-5/8"	chrome	159.99 ea
MW846	14" x 8"	4-5/8"	silver	109.99 ea
MW847	15" x 7"	4-1/4"	chrome	154.99 ea
MW848	15" x 7"	4-1/4"	silver	109.99 ea
MW849	15" x 8"	4-5/8"	chrome	159.99 ea
MW850	15" x 8"	4-5/8"	silver	111.99 ea
MW851	15" x 10"	5"	chrome	214.99 ea
MW852	15" x 10"	5"	silver	214.99 ea
MW853	15" x 10"	5-1/2"	chrome	214.99 ea
MW854	15" x 10"	5-1/2"	silver	214.99 ea



MFW925

MFW900

MW897

1970-74 Wheel Trim Rings

14" Rallye Trim Rings

Replacement for 1970-74 Rallye wheel trim rings for various Dodge and Plymouth models. Features correct contours and stainless finish.

MW925	1970-74	14" x 6"	34.99 ea
MW900	1970-74	14" x 7"	51.99 ea

15" x 7" Trim Rings

Replacement trim rings for various Dodge and Plymouth models equipped with 15 x 7" wheels. Available in the correct polished finish for 1970 models and brushed aluminum finish for 1971 and later models.

MW897	1970	polished	44.99 ea
MW898	1971-74	brushed aluminum	49.99 ea

New!



Deep Dish Trim Rings with Stepped Edge

Triple chrome plated stainless steel trim rings for models with Rally Wheels. These trim rings combine the durability of stainless steel with the deep luster of chrome for a custom look that will last. The 15" trim ring is designed as a replacement for the 15" x 7" and 15" x 8" Road Wheel or Magnum 500 wheel. Sold in sets of four. MP500668 15" x 7" Road Wheel 119.99 set
MP500668 15" x 8" Road Wheel 119.99 set



MD2312 - light argent

MD2313 - dark argent

MD2314 - light argent

MD2315 - dark argent

MD2310 - small pattern

MD2311 - large pattern

1970-74 Rallye Wheel Caps

1970-71 A-Body Rallye Wheel Cap Sets

Rallye wheel caps for 1970-71 A-Body models with the small 5 x 4" bolt pattern wheels. Features correct argent finish, correct stainless accents and are sold in sets of four.

MD2312	1970	light argent	174.99 set
MD2313	1971	dark argent	174.99 set

1970-71 B & E-Body Rallye Wheel Cap Sets

Rallye wheel caps for 1970-71 B & E-Body models with the large 5 x 4-1/2" bolt pattern wheels. Features correct argent finish, correct stainless accents and is sold as a set of four.

MD2314	1970	light argent	174.99 set
MD2315	1971	dark argent	174.99 set

1972-74 Acorn Rallye Wheel Cap Sets

Rallye wheel caps for various Dodge and Plymouth models. The small bolt pattern features the correct stainless and dark argent finish, the large bolt part features the light argent finish with stainless accents. The small lug pattern is 5 x 4" and the large is 5 x 4-1/2". Sold as a set of four.

MD2310	1972-74	small pattern 5 x 4"	164.99 set
MD2311	1972-74	large pattern 5 x 4-1/2"	174.99 set



Wheels & Accessories

How To Measure Wheel Backspacing

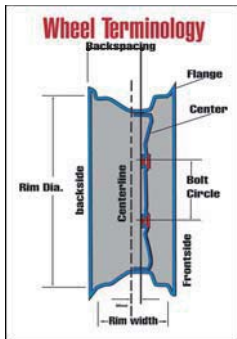

How to Measure Wheel Offset

To calculate the wheel offset, you will need the following measurements:

- **Wheel Centerline** (outboard flange to inboard flange ÷ 2)
- **Wheel Backspace**
- **Wheel Width**

Subtract wheel centerline from wheel backspace. If the backspace number is smaller than the wheel center line number, your offset is negative. If the backspace number is greater than the wheel centerline number, your offset is positive. To convert from inches to mm, multiply by 25.4. To convert from mm to inches, divide by 25.4.

How to Measure Wheel Backspacing

- **Tape Measure**
- **Straight Edge**
- **Wheel (preferably with tire dismounted)**

Lay the wheel face down on the ground with the backside of the wheel facing up. Take a straight edge and lay it horizontally across the backside of the wheel. With the tape measure, measure the distance from where the wheel center makes contact with the drum or rotor to where the straight edge contacts the backside flange.

How to Measure Bolt Patterns

On five lug wheels, measure from the back side of the top hole to the center of the second hole. In the examples given above, the first number represents the number of lugs while the second number represents the measurement in inches.



5 x 4"
or
5 x 4.5"



Professional Brushes For Enthusiasts!

These are professional type brushes that are the finest on the market. They feature ergonomically correct, soft padded handles for hours of use with less fatigue. A soft rubber edging surrounding the edges on the bristle portion of the brush helps to prevent accidental scratches and dings to the vehicle. Several kits are available to meet your needs.

Specialty Small Brush Set

BS201 7 piece 29.99 set

Body Wash Brush Set

BS202 3 piece 10" handles 26.99 set

BS203 3 piece 20" handles 33.99 set

Buy the Complete Set and Save!

BS204 13 piece complete brush set 88.99 set



Specialty Brushes

Keep your vehicle shining with these high-quality specialty brushes. Each brush is specially designed for the application indicated.

TW119 upholstery brush 4.99 ea

TW117 tire brush 3.99 ea

TW114 wheel and bumper brush 4.99 ea

TW121 medium grill/spoke brush 5.99 ea

K89497 soft foam wheel/spoke brush 9.99 ea

Mopar "Police" Wheels

Command respect as you patrol your local cruise in with these Mopar "Police" wheels. The classic 6-hole police wheel design provides the rugged interceptor look of vintage Mopar law enforcement vehicles. The rugged black paint completes the aggressive look with its robust, corrosion-resistant formula. Wheels have 5 x 4-1/2" lug pattern. Hubcaps and lug nuts not included.

Note: Shipped overweight.

5 x 4-1/2" Bolt Pattern

Item#	Size	Backspacing	Description	Price
MW695634	15" x 6"	3-3/4"	"Police" Wheel.....	111.99 ea
MW695740	15" x 7"	4"	"Police" Wheel.....	111.99 ea
MW695840	15" x 8"	4"	"Police" Wheel.....	111.99 ea
MW695845	15" x 8"	4-1/2"	"Police" Wheel.....	111.99 ea
MW695055	15" x 10"	5-1/2"	"Police" Wheel.....	169.99 ea



Wheels & Accessories

1969-Up Road Wheels

Road Wheels for 1969 and later Dodge and Plymouth models. This is the exact same wheel as the Magnum 500 with the exception of a black powder coated rim. Replace your damaged originals with this quality all steel constructed replacement. Available in various sizes for vehicles with the 5" x 4-1/2" lug pattern. Trim ring, center cap and lug nuts are not included.

Note: Shipped overweight.



5 x 4-1/2" Bolt Pattern				
Item#	Size	Backspacing	Description	Price
MW869	14" x 6"	4"	Road Wheel	159.99 ea
MW870	14" x 7"	4-1/8"	Road Wheel	164.99 ea
MW916	15" x 7"	4-1/4"	Road Wheel	169.99 ea
MW871	15" x 8"	4-1/2"	Road Wheel	174.99 ea



1967-71 Wheel Center Cap Inserts

Replacement center cap inserts for 1967-68 Magnum and 1970-71 Rallye Wheels. Each aluminum insert features correct finish and correct patterned center for an authentic appearance. Attaches with quality 3M adhesive backing. Sold in a set of 4.

MMS278	1967-68	Magnum wheel center cap insert set	19.99 set
MMS277	1970-71	Rallye wheel center cap insert set	14.99 set



Billet Rallye Wheels

Give your classic Mopar a complete new look with Billet Rallye wheels. Billet wheels are manufactured from two solid billet aluminum blocks, which are CNC machined for lightweight performance and classic styling. Then the hoop and center are assembled to the predetermined backspacing and welded. This wheel is modeled after the original Rally wheel. Features fully polished wheel with painted slots. Wheels do not include center cap or lug nuts.

Note: Shipped overweight.

5 x 4" Bolt Pattern				
Item#	Size	Backspacing	Description	Price
MW814	16" x 7"	4-1/4"	Billet Rallye	549.99 ea
MW815	16" x 8"	4-5/8"	Billet Rallye	549.99 ea
MW816	16" x 9-1/2"	4-1/2"	Billet Rallye	579.99 ea
MW817	17" x 7"	4-1/4"	Billet Rallye	499.99 ea
MW818	17" x 8"	4-5/8"	Billet Rallye	509.99 ea
MW819	18" x 7"	4-1/4"	Billet Rallye	524.99 ea
MW820	18" x 8"	4-5/8"	Billet Rallye	529.99 ea
MW821	18" x 9-1/2"	5-1/2"	Billet Rallye	539.99 ea

5 x 4-1/2" Bolt Pattern				
Item#	Size	Backspacing	Description	Price
MW822	16" x 7"	4-1/4"	Billet Rallye	549.99 ea
MW823	16" x 8"	4-1/2"	Billet Rallye	549.99 ea
MW824	16" x 9-1/2"	4-1/4"	Billet Rallye	579.99 ea
MW825	17" x 7"	4-1/4"	Billet Rallye	499.99 ea
MW826	17" x 8"	4-1/4"	Billet Rallye	509.99 ea
MW827	17" x 8-1/2"	5-1/2"	Billet Rallye	519.99 ea
MW828	18" x 7"	4-1/4"	Billet Rallye	524.99 ea
MW829	18" x 8"	4-1/2"	Billet Rallye	529.99 ea
MW830	18" x 9-1/2"	5-1/2"	Billet Rallye	539.99 ea



RV89650A



RV89650P



RV89650C

Rev Classic 100 Wheels

These Classic 100 wheels from Rev Wheels give you a classic look with today's modern manufacturing, machining, and materials. The Classic 100 design is available with anthracite, polished, or chrome finish. Available in 15", 17", 18", and 20" diameters. Includes the center cap. Lug nuts sold separately.

Note: Shipped overweight.

Anthracite Center					
Item #	Size	Bolt Pattern	Offset	Backspacing	
RV56650A	15" x 6"	5 x 4-1/2"	0mm	3-1/2"	114.99 ea
RV57650A	15" x 7"	5 x 4-1/2"	0mm	4"	119.99 ea
RV58650A	15" x 8"	5 x 4-1/2"	0mm	4-1/2"	119.99 ea
RV77650A	17" x 7"	5 x 4-1/2"	0mm	4"	129.99 ea
RV78650A	17" x 8"	5 x 4-1/2"	0mm	4-1/2"	129.99 ea
RV78651A	17" x 8"	5 x 4-1/2"	+12mm	5"	129.99 ea
RV79650A	17" x 9"	5 x 4-1/2"	0mm	5"	144.99 ea
RV79651A	17" x 9"	5 x 4-1/2"	+12mm	5-1/2"	144.99 ea
RV83650A	18" x 8"	5 x 4-1/2"	0mm	4-1/2"	159.99 ea
RV28650A	20" x 8"	5 x 4-1/2"	0mm	4-1/2"	199.99 ea
RV29651A	20" x 9.5"	5 x 4-1/2"	+15mm	5-3/4"	204.99 ea

Polished Center					
Item #	Size	Bolt Pattern	Offset	Backspacing	
RV56650P	15" x 6"	5 x 4-1/2"	0mm	3-1/2"	129.99 ea
RV57650P	15" x 7"	5 x 4-1/2"	0mm	4"	144.99 ea
RV58650P	15" x 8"	5 x 4-1/2"	0mm	4-1/2"	129.99 ea
RV77650P	17" x 7"	5 x 4-1/2"	0mm	4"	149.99 ea
RV78650P	17" x 8"	5 x 4-1/2"	0mm	4-1/2"	159.99 ea
RV78651P	17" x 8"	5 x 4-1/2"	+12mm	5"	159.99 ea
RV79650P	17" x 9"	5 x 4-1/2"	0mm	5"	169.99 ea
RV79651P	17" x 9"	5 x 4-1/2"	+12mm	5-1/2"	164.99 ea
RV83650P	18" x 8"	5 x 4-1/2"	0mm	4-1/2"	174.99 ea

Chrome Wheel					
Item #	Size	Bolt Pattern	Offset	Backspacing	
RV56650C	15" x 6"	5 x 4-1/2"	0mm	3-1/2"	159.99 ea
RV57650C	15" x 7"	5 x 4-1/2"	0mm	4"	179.99 ea
RV58650C	15" x 8"	5 x 4-1/2"	0mm	4-1/2"	159.99 ea
RV67650C	16" x 7"	5 x 4-1/2"	0mm	4"	169.99 ea
RV68650C	16" x 8"	5 x 4-1/2"	0mm	4-1/2"	199.99 ea
RV77650C	17" x 7"	5 x 4-1/2"	0mm	4"	189.99 ea
RV78650C	17" x 8"	5 x 4-1/2"	0mm	4-1/2"	214.99 ea
RV78651C	17" x 8"	5 x 4-1/2"	+12mm	5"	214.99 ea
RV79650C	17" x 9"	5 x 4-1/2"	0mm	5"	224.99 ea
RV79651C	17" x 9"	5 x 4-1/2"	+12mm	5-1/2"	224.99 ea
RV83650C	18" x 8"	5 x 4-1/2"	0mm	4-1/2"	249.99 ea
RV83651C	18" x 8"	5 x 4-1/2"	+12mm	5"	249.99 ea
RV28650C	20" x 8"	5 x 4-1/2"	0mm	4-1/2"	289.99 ea
RV29651C	20" x 9.5"	5 x 4-1/2"	+15mm	5-3/4"	299.99 ea

Wheels & Accessories

New!



RF576542G



RF576542P

Rocket "Fuel" Wheels

Get timeless styling with the precision-crafted Rocket "Fuel" wheel. Manufactured from A356 aluminum, the "Fuel" wheel provides a traditional hot rod look topped off with a vintage style aluminum oil-ring center cap. Choose from painted gray centers with machined lip, fully polished, or chrome.

5 x 4.50" Bolt Pattern - Gray Painted with Machined Outer

RF566535G	15" x 6", 3.50" backsparing	189.99 ea
RF576542G	15" x 7", 4.25" backsparing	189.99 ea
RF586545G	15" x 8", 4.50" backsparing	199.99 ea
RF776542G	17" x 7", 4.25" backsparing	249.99 ea
RF786545G	17" x 8", 4.50" backsparing	259.99 ea

5 x 4.50" Bolt Pattern - Polished Finish

RF566535P	15" x 6", 3.50" backsparing	209.99 ea
RF576542P	15" x 7", 4.25" backsparing	214.99 ea
RF586545P	15" x 8", 4.50" backsparing	219.99 ea
RF776542P	17" x 7", 4.25" backsparing	259.99 ea
RF786545P	17" x 8", 4.50" backsparing	269.99 ea

5 x 4.50" Bolt Pattern - Chrome

RF566535C	15" x 6", 3.50" backsparing	274.99 ea
RF576542C	15" x 7", 4.25" backsparing	279.99 ea
RF586545C	15" x 8", 4.50" backsparing	284.99 ea
RF776542C	17" x 7", 4.25" backsparing	349.99 ea
RF786545C	17" x 8", 4.50" backsparing	354.99 ea

New!



Cragar
Classic Wheels

61614

Cragar S/S Super Sport Wheels

The Cragar S/S wheel was first introduced in 1964. By 1974 the Cragar S/S had become one of the most popular wheels of the muscle car era. Because it was chrome plated rather than polished aluminum, it held its shine and was easier to keep clean. Instead of requiring time consuming polishing, the Cragar S/S was ready to show with a simple hosing off and wiping down. Available in a variety of sizes and configurations, these wheels are now back in vogue with muscle car enthusiasts who prefer a custom look, but wish to keep their car "period correct". Chrome aluminum center cap is included with each wheel. Lug nuts sold separately. Note: Shipped overweight.

Item #	Size	Bolt Pattern	Offset	Backspacing	
61614	14" x 6"	5 x 4.5", 4.75", 5"	-3mm	3-3/8"	199.99 ea
61714	14" x 7"	5 x 4.5", 4.75", 5"	3mm	4-1/8"	199.99 ea
61814	14" x 8"	5 x 4.5", 4.75", 5"	-6mm	4-1/4"	199.99 ea
8415	15" x 4.5"	5 x 4.5", 4.75", 5"	-19mm	2"	219.99 ea
61615	15" x 6"	5 x 4.5", 4.75", 5"	3mm	3-3/8"	199.99 ea
61715	15" x 7"	5 x 4.5", 4.75", 5"	3mm	4-1/8"	199.99 ea
61815	15" x 8"	5 x 4.5", 4.75", 5"	-6mm	4-1/4"	199.99 ea
61015	15" x 10"	5 x 4.5", 4.75", 5"	-32mm	4-1/4"	229.99 ea
617712	17" x 7"	5 x 4.5"	-6mm	3-3/4"	289.99 ea
617812	17" x 8"	5 x 4.5"	-25mm	3-1/2"	289.99 ea
617812P	17" x 8"	5 x 4.5"	0mm	4-1/2"	289.99 ea
617912	17" x 9"	5 x 4.5"	13mm	4-1/2"	299.99 ea
617912P	17" x 9"	5 x 4.5"	+13mm	5-1/2"	299.99 ea



SW117703



SW117701

Showwheels Aluminum Wheels

Looking for a wheel upgrade for your classic ride? Look no further. Showwheels Streeters are one of the best looking and fitting muscle car wheels available. They have the deep lip look of modern wheels, but for your classic! Available with gray centers or fully polished, in 17, 18 and 20 inch diameters. Comes complete with caps (chrome metal, hex head screw on) and chrome lug nuts.

Important: The lug nuts supplied with each wheel are for vehicles with right hand threaded studs. Vehicles with left hand threaded studs will have to be converted to all right hand threaded studs. Note: Wheel with 5 x 4" pattern include special lug nuts and tool. Shipped overweight.

Gray center					
Item#	Size	Pattern	Offset	Backspacing	Price
SW117701	17" x 7"	5 x 4"	+6mm	4.25"	164.99 ea
SW117801	17" x 8"	5 x 4"	0mm	4.5"	164.99 ea
SW117802	17" x 8"	5 x 4-1/2"	+6mm	4.75"	164.99 ea
SW118701	17" x 7"	5 x 4"	+6mm	4.25"	184.99 ea
SW118702	17" x 7"	5 x 4-1/2"	+6mm	4.25"	184.99 ea
SW118802	18" x 8"	5 x 4-1/2"	+6mm	4.75"	184.99 ea
SW120801	20" x 8.5"	5 x 4-1/2"	+12mm	5.25"	234.99 ea

Polished center					
Item#	Size	Pattern	Offset	Backspacing	Price
SW117703	17" x 7"	5 x 4"	+6mm	4.25"	184.99 ea
SW117704	17" x 7"	5 x 4-1/2"	+6mm	4.25"	184.99 ea
SW117803	17" x 8"	5 x 4"	0mm	4.5"	184.99 ea
SW117804	17" x 8"	5 x 4-1/2"	+6mm	4.75"	184.99 ea
SW118703	18" x 7"	5 x 4"	+6mm	4.25"	204.99 ea
SW118704	18" x 7"	5 x 4-1/2"	+6mm	4.25"	204.99 ea
SW118803	18" x 8"	5 x 4"	0mm	4.5"	204.99 ea
SW118804	18" x 8"	5 x 4-1/2"	+6mm	4.75"	209.99 ea
SW120802	20" x 8.5"	5 x 4-1/2"	+12mm	5.25"	254.99 ea



WK26

Mag Lug Nut Sets for 14" & 15" Cragar S/S 61 Series Wheels

Lug nut sets WK25-WK26 include: 20 SS mag lug nuts, 20 center-drilled and 20 offset-drilled Cragar mag washers, 1 lock set and 4 valve stems. For all 14" & 15" Cragar S/S wheels.

WK25	7/16" SS mag lugs	39.99 set
WK26	1/2" SS mag lugs	39.99 set

New!



WK55

Acorn Lug Nut Sets for 17" Cragar S/S 61 Series Wheels

Lug nut sets WK55-WK56 include: 20 bulged acorn lug nuts, 1 lock set and 4 valve stems. Designed to mount all 17" Cragar S/S wheels.

WK55	7/16" bulged acorn lugs	39.99 set
WK56	1/2" bulged acorn lugs	39.99 set

Wheels & Accessories

New!

Cragar 390 Street Pro

The style of the Cragar Street Pro is reminiscent of the Halibrand Sprint which was made famous on the circle track cars of the 60s. The similarities stop there, however. Unlike the Halibrand which was made of magnesium and required constant polishing to retain its shine, the Cragar street pro is manufactured of a chrome plated steel rim with a chrome plated aluminum center. They clean up easily and retain their shine with a simple hosing off and wiping down. The price of original 60s era Halibrands has been pushed up by collectors and the new Halibrand wheels are also very pricey. So, if you'd like the look of a legend at about 1/4 of the price, the Cragar Street Pro is definitely the way to go. Chrome aluminum center cap is included with each wheel. Lug nuts sold separately.

Note: Shipped overweight.



Item #	Size	Bolt Pattern	Offset	Backspacing	
390560S	15" x 6"	5 x 4.5", 4.75"	-28mm	2-5/8"	219.99 ea
390570S	15" x 7"	5 x 4.5", 4.75"	-12mm	3-1/2"	219.99 ea
390580S	15" x 8"	5 x 4.5", 4.75"	-6mm	4-1/4"	219.99 ea
390510S	15" x 10"	5 x 4.5", 4.75"	-32mm	4-1/4"	229.99 ea
390780S	17" x 8"	5 x 4.5", 4.75"	-25mm	3-1/2"	279.99 ea
390780SP	17" x 8"	5 x 4.5", 4.75"	-6mm	4-1/4"	279.99 ea
390790S	17" x 9"	5 x 4.5", 4.75"	-12mm	4-1/2"	299.99 ea
390790SP	17" x 9"	5 x 4.5", 4.75"	6mm	5-1/4"	299.99 ea

Lug Nut Sets for 390 Street Pro Wheels

All lug nut sets listed below include: 20 OE flanged lug nuts, 1 lock set and 4 valve stems.

WK12	7/16" OE flanged lugs	39.99 set
WK13	1/2" OE flanged lugs	39.99 set

New!



Replacement Center Caps and Spinners

Replace your missing or damaged center cap with an original Cragar cap or dress up your Cragar wheels with a new set of Cragar spinner caps.

Spinner (pkg of 2)		
0909S2	for S/S wheel (with Cragar S/S logo)	49.99 pr
Replacement Center Cap (each)		
390SK	for Street Pro wheel (with base and spinner)	84.99 ea
9090	for S/S wheel (with Cragar S/S logo)	19.99 ea
KC0271	for Keystone Classic wheel	19.99 ea

New!

Cragar 32 Series Keystone Classics

If your car is a 1960-70s model, chances are it came with narrow wheels and tiny bias ply tires. By the mid 1960s, aftermarket wheel swaps were commonplace among car enthusiasts. One of the most widely chosen aftermarket wheels available during the muscle car era was the Cragar Keystone Classic. Popular for their composite design, the chrome plating on the Keystone Classics made them much easier to clean than aluminum or mag wheels because they required no polishing. Cleaning them was a breeze by just hosing them down and wiping them off. These wheels are now back in vogue with muscle car enthusiasts who prefer a custom look, but wish to keep their car "period correct". Chrome aluminum center cap is included with each wheel. Lug nuts sold separately.

Note: Shipped overweight.



Item #	Size	Bolt Pattern	Offset	Backspacing	
325799	15" x 7"	5 x 4.5", 4.75", 5"	-6mm	3-3/4"	219.99 ea
325899	15" x 8"	5 x 4.5", 4.75", 5"	-16mm	3-7/8"	219.99 ea

Mag Lug Nut Sets for 32 Series Keystone Classic Wheels

Lug nut sets WK38-WK40 include: 20 SS mag lug nuts, 20 center-drilled and 20 offset-drilled Keystone mag washers, 1 lock set and 4 valve stems.		
WK38	7/16" SS mag lugs	39.99 set
WK39	1/2" SS mag lugs	39.99 set
WK40	12mm x 1.5 SS mag lugs	39.99 set

New!



Smoothie Wheels

The ultimate nostalgic wheel, the chrome smoothie provides a look like no other. It is often used with whitewalls and baby moons. A chrome moon center cap is included with each wheel, but with a little ingenuity, this wheel can provide many different looks for your vehicle. Available in a variety of different sizes. Lug nuts sold separately.

Note: Shipped overweight.



Item #	Size	Bolt Pattern	Offset	Backspacing	
313460SP	14" x 6"	5 x 4.5", 4.75"	7mm	3-3/4"	89.99 ea
313470S	14" x 7"	5 x 4.5", 4.75"	0mm	4"	99.99 ea
313560SP	15" x 6"	5 x 4.5", 4.75"	7mm	3-3/4"	99.99 ea
313570SP	15" x 7"	5 x 4.5", 4.75"	3mm	4-1/8"	109.99 ea
313580S	15" x 8"	5 x 4.5", 4.75"	-15mm	4-1/4"	109.99 ea
313510S	15" x 10"	5 x 4.5", 4.75"	-38mm	4-1/4"	139.99 ea
313780SP	16" x 8"	5 x 4.5", 4.75"	12mm	5"	104.99 ea

Lug Nut Sets for Smoothie Wheels

Classic Industries' now offers a lug set kit for your smoothie wheels. A perfect kit to purchase if your lug nuts are stripped, worn out or rusted. All sets include: 16 lug nuts, 4 valve stems, 4 wheel locks and a key.

WK1	7/16" - 20 thread	39.99 set
WK2	1/2" - 20 thread	39.99 set

Wheels & Accessories

American Racing
Custom Wheels

Torq-Thrust D Chrome

This classic design from American Racing Wheels, burst on the scene way back in 1965 and became the most famous custom wheel of all time. The one-piece, 5-spoke design is a timeless classic. Get a true nostalgic look when adding a set of these precision machined beauties. Includes center cap.

Note: Shipped overweight.



Item #	Size	Bolt Pattern	Offset	Backspacing	Price
MW877	14" x 6"	5 x 4-1/2"	-2mm	3-3/8"	251.99 ea
MW878	15" x 6"	5 x 4-1/2"	+4mm	3-5/8"	289.99 ea
MW879	15" x 7"	5 x 4-1/2"	-5mm	3-3/4"	289.99 ea
MW880	15" x 8-1/2"	5 x 4-1/2"	-24mm	3-3/4"	299.99 ea

American Racing
Custom Wheels

Torq-Thrust D

This classic design from American Racing Wheels burst on the scene way back in 1965 and became the most famous custom wheel of all time. The one-piece, alloy, 5-spoke design is a timeless classic. Get a true nostalgic look when adding a set of these precision-machined beauties. Center cap included.

Note: Shipped overweight.



Item #	Size	Bolt Pattern	Offset	Backspacing	Price
MW881	14" x 6"	5 x 4-1/2"	-2mm	3-3/8"	181.99 ea
MW882	15" x 6"	5 x 4-1/2"	+4mm	3-5/8"	194.99 ea
MW883	15" x 7"	5 x 4-1/2"	-6mm	3-3/4"	199.99 ea
MW884	15" x 8-1/2"	5 x 4-1/2"	-25mm	3-3/4"	214.99 ea
MW885	16" x 8"	5 x 4-1/2"	-12mm	4"	214.99 ea

American Racing
Custom Wheels

T.T.O Alloy Wheels

This straight spoke version of the Torq-Thrust is an icon of vintage and muscle cars throughout America. The TTO was originally offered in 1956 and quickly became the most sought after design of its time. Includes center cap.

Note: Shipped overweight.



Item #	Size	Bolt Pattern	Offset	Backspacing	Price
MW886	15" x 5"	5 x 4-1/2"	-13mm	2-1/2"	191.99 ea
MW887	15" x 7"	5 x 4-1/2"	-6mm	3-3/4"	199.99 ea
MW888	15" x 8-1/2"	5 x 4-1/2"	-24mm	3-3/4"	214.99 ea
MW889	17" x 8"	5 x 4-1/2"	0mm	4-1/2"	241.99 ea

American Racing
Custom Wheels

Torque Thrust II Polished Alloy

A classic 5-spoke design with a modern flair. This handsome 2-piece alloy wheel comes fully polished and features a spoke design that is more tapered, creating a wider viewing area to unveil the disc-brake stopping power behind your Mopar. Many sizes to choose from. Includes center cap.

Note: Shipped overweight.



Item #	Size	Bolt Pattern	Offset	Backspacing	Price
MW890	15" x 8"	5 x 4-1/2"	-18mm	3-3/4"	289.99 ea
MW891	16" x 8"	5 x 4-1/2"	-11mm	4"	311.99 ea

American Racing
Custom Wheels

The American Racing Outlaw

In the 1980's the modular wheel became the hot ticket on any late 70's or 80's muscle car. The wheels were called modular because they consisted of three elements... an aluminum wheel center (in various styles), an inner rim and an outer rim. The combination of these "modules" allowed for an unlimited range of possibilities when it came to wheel specifications. The true modular style wheels, however, were a bit pricey for the average Joe. This soon led to an influx of modular copies and 1-piece wheels built with a modular look. This modular style wheel is manufactured by American Racing. It is a 1-piece machined alloy wheel with a modular look. It comes clear coated and includes center cap. It's a good choice if you're looking for a period correct wheel design at a great price.

Note: Shipped overweight.



Item #	Size	Bolt Pattern	Offset	Backspacing	Price
MW893	14" x 7"	5 x 4-1/2"	0mm	4"	94.99 ea
MW894	15" x 7"	5 x 4-1/2"	-6mm	3-3/4"	114.99 ea
MW895	15" x 8"	5 x 4-1/2"	-19mm	3-3/4"	119.99 ea
MW896	15" x 10"	5 x 4-1/2"	-38mm	4"	121.99 ea

American Racing
Custom Wheels



Tri-Bar Center Caps

Now from American Racing! The most popular custom wheels for classic muscle cars are now available with logo center caps or spinners. CC502 Tri-Bar119.99 ea

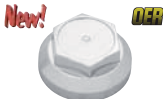

Hex Style Wheel Center Cap

OER® reproduction wheel center cap manufactured from high quality chrome-plated injection molded ABS plastic with a stamped steel insert. Each cap is designed exactly like the original as a two-piece screw-on style cap that includes the ABS center cap, steel retainer and Phillips head screw. Fits aluminum wheels of the era with a 2-1/2" center bore. Cap will accept a 1-3/4" center emblem. Sold individually. K676 hex cap39.99 ea

STEERING, SUSPENSION, REAR END & BRAKES

Wheels & Accessories



1960-76 Front and Rear Right Hand Thread Wheel Studs

Classic Industries® has replacement wheel studs for your Mopar. These studs are right hand thread and will work on either side of your vehicle. Take the time to check what you have on your vehicle.

Important: If you are replacing left hand studs with right hand studs; make sure you purchase the right hand lug nuts.

A-Body				
Item #	Year	Length	Knurl Dia.	Application
Front Axle - 7/16"-20				
MA4804	1960-69	1-3/8"	.570"	w/9" drum; steel encased ... 2.99 ea
MA4805	1965-72	1-1/4"	.563"	w/9" drum 2.99 ea
MA4806	1965-72	1-7/16"	.555"	w/10" drum 2.99 ea
MA4807	1965-72	1-31/32"	.565"	w/front disc brakes 3.99 ea
Front Axle - 1/2"-20				
MD4709	1973-76	1-5/8"	.620"	w/Motor Wheel rotor 2.99 ea
Rear Axle - 7/16"-20				
MA4808	1973-76	1-5/8"	.570"	w/front drum brakes 2.99 ea
MA4809	1960-76	1-1/2"	.472"	w/front drum brakes 2.99 ea
Rear Axle - 1/2"-20				
MD4706	1968-76	1-19/32"	.673"	w/front disc brakes 2.99 ea

B-Body				
Item #	Year	Length	Knurl Dia.	Application
Front Axle - 1/2"-20				
MD4705	1960-70	1-5/8"	.625"	w/10" drums 3.99 ea
MD4710	1962-64	1-1/16"	.673"	all except Detroit Built 3.99 ea
MD4707	1966-70	1-9/16"	.650"	w/10" drum; Budd 2.99 ea
MD4708	1965-72	1-5/8"	.650"	w/11" drum 3.99 ea
MB6101	1966-67	1-3/4"	.637"	w/front disc brakes 2.99 ea
MD4711	1970-72	1-1/16"	.625"	w/front disc brakes 3.99 ea
MD4710	1971-72	1-1/16"	.673"	w/11" Kelsey Hayes drum... 3.99 ea
MD4709	1973-76	1-5/8"	.620"	w/Motor Wheel rotor 2.99 ea
Rear Axle - 1/2"-20				
MD4704	1960-64	1-1/2"	.645"	w/10" front drums 2.99 ea
MD4706	1962-76	1-19/32"	.673" 2.99 ea

E-Body				
Item #	Year	Length	Knurl Dia.	Application
Front Axle - 1/2"-20				
MD4707	1970	1-9/16"	.650"	w/10" drum; Budd 2.99 ea
MD4708	1970-72	1-5/8"	.650"	w/11" drum 2.99 ea
MD4709	1973-74	1-5/8"	.620"	w/Motor Wheel rotor 2.99 ea
MD4711	1970-72	1-1/16"	.625"	w/front disc brakes 3.99 ea
MD4710	1971-72	1-1/16"	.673"	w/11" Kelsey Hayes drum... 3.99 ea
Rear Axle - 1/2"-20				
MD4706	1970-74	1-19/32"	.673" 2.99 ea



Don't Forget the Wheel Hardware!

A perfect set to purchase when mounting new American Racing wheels to your vehicle or when your current lug nuts are stripped, worn out or missing. All sets include: 20 lug nuts, 4 valve stems, 4 wheel locks and lug key.

WK4	7/16"-20 thread-RH thread	39.99 set
WK5	1/2"-20 thread-RH thread	39.99 set

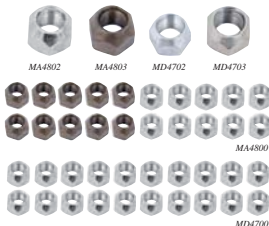

1960-76 Standard Lug Nuts

Standard lug nuts for 1960-76 models with standard wheels and hub caps. Zinc plated except where green chromate plating is noted. All are 3/4" hex lug nuts and offered with 7/16"-20 or 1/2"-20 LH or RH threads.

Note: 1970 and earlier models have 10 LH thread and 10 RH thread lug nuts. 1971 and later models have 20 RH thread lug nuts.

7/16"-20 Lug Nuts				
MA4802	RH thread	diamonds on top	2.49 ea
MA4803	LH thread	chromate coated	2.49 ea
MA4800	RH/LH thread	set of 20	44.99 set
MA4801	RH thread	set of 20	44.99 set
1/2"-20 Lug Nuts				
MD4702	RH thread	2.49 ea
MD4703	LH thread	2.49 ea
MD4712	LH thread	"Left" on top	2.49 ea
MD4700	RH/LH thread	set of 20	44.99 set
MD4701	RH thread	set of 20	44.99 set



McGard® Lug Nut & Lock Kits

These specially designed McGard® nut and lock kits are made to last a lifetime. Guaranteed to out shine the competition long after others have rusted away. Each nut is identified by size directly on the head, chrome-plated and case-hardened completely through. The thread strength meets or exceeds OEM specifications. Kits include 4 locks and 16 nuts.

13/16" Hex - Chrome	1/2"-20 thread - RH thread	53.99 kit
3/4" Hex - Chrome	1/2"-20 thread - RH thread	64.99 kit
K64010	7/16"-20 thread - RH thread	64.99 kit



Chrome Lug Nuts

These O.E.-quality chrome lug nuts are designed for use with Road and Rallye wheels, as well 1969-1972 A12 six-barrel Road Runner and Six Pack Super Bee models. Available in left- and right-hand thread. These lug nuts are 1" long 1/2"-20 SAE thread.

<i>Note: for 1970 and earlier models, order 10 LH and 10 RH, for 1971 and top order 20 RH. Will not fit 1962-72 A-Bodies.</i>		
MN1712	LH	9.99 ea
MN1762	RH	9.99 ea

Left Hand/Right Hand Lug Nuts

Keep your wheels secure and looking great with a brand new set of lug nuts.

These chrome-finished acorn style lug nuts feature 7/16"-20 thread and 13/16" overall hex heads are available in both left hand and right hand thread. These are some of the few left handed lug nuts still available and offer a great way to maintain authenticity and enhance your appearance. Sold individually.

WK81R	1960-76 RH	1.49 ea
WK81L	1960-76 LH	1.49 ea

Wheels & Accessories

New!



CP50018A CP50018B CP50018C

CP50018D CP50018E CP50018F CP50018G



CP50019A CP50019B CP50020A CP50020B



CP50022A CP50022B CP50022C



CP50022D CP50022E CP50022F



CP50023A CP50023B



CP50024I CP50024J

Custom Valve Stem Caps

Looking for something to set your wheels apart from the rest? Looking to add a personal touch to your curb feelers? Look no further than custom valve stem caps. Choose the design that suits your style. Sold as a set of 4.

Dice Style Caps

CP50018A	red	2.99 set
CP50018B	white	2.99 set
CP50018C	black	2.99 set
CP50018D	blue	2.99 set
CP50018E	green	2.99 set
CP50018F	purple	2.99 set
CP50018G	chrome	4.99 set

Skull Style w/Red Eyes

CP50019A	white	5.99 set
CP50019B	chrome	5.99 set

"8" Ball Style

CP50020A	black	2.99 set
CP50020B	chrome	5.99 set

Deluxe "Swarovski" Diamond Style

CP50022A	blue	14.99 set
CP50022B	green	14.99 set
CP50022C	purple	14.99 set
CP50022D	clear	14.99 set
CP50022E	red	14.99 set
CP50022F	amber	14.99 set

Hex Nut "Mushroom" Style

CP50021A	chrome	2.99 set
----------	--------	----------

Piston Style

CP50023A	chrome	11.99 set
----------	--------	-----------

Ballet Style

CP50024I		6.99 set
----------	--	----------

Bullet Head Style

CP50024J		4.99 set
----------	--	----------



KG005

KG003

Tire Storage Solutions

Store your tires with care and ease with these tire storage solutions for various applications. The Tire Garage allows you to keep tires outside with a rugged weatherproof shell made from the same material used to make awnings and boat covers. The Seasonal Tire Tote provides mobile protection for your seasonal tires. Features a heavy duty shell and easy to carry handles. They are also easily stackable. Tire Tote Wheel Felts slide into the tire tote and clip into place to protect wheels from scratches and nicks.

KG005	tire garage	one size fits all	39.99 ea
KG003	tire tote	one size fits all	19.99 pr
KG007	wheel felts	20" diameter	12.99 pr



Wall Mount Wheel/Tire Hanger

The wheel and tire hanger is a great way to organize your shop or garage by getting wheels and tires off the floor, freeing up more space. Each heavy duty powder coated hanger is approx. 21" long and mounts at a slight angle so wheels won't slide off. Can also be used to hang bicycles or anything you want to get off the floor.

Note: Each hanger will hold 2 wheels with tires mounted. M998070 wheel/tire hanger..... 39.99 ea



O-100 PSI Digital Tire Pressure Gauge

Proform's programmable Digital Tire Pressure Gauge measures from 0-100 PSI in increments of .01 PSI on a backlit LCD screen. When you remove the gauge from the valve stem in NORMAL mode, the gauge will slowly count back to zero. In PEAK mode, the reading will display after removal. Features unit conversion (PSI, bars and kg/cm²), automatic OFF, and dual air bleed buttons to allow controlled pressure release. Instructions included.

67399		154.99 ea
-------	--	-----------



K89490

K89491

K89498

Secret Weapon Polish Ball

The Secret Weapon Polish Ball bends and compresses enabling it to fit into tight spaces and make the cleaning and polishing of difficult, hard to reach areas like wheels, rims and other metal work much easier. Can be attached to any hand held drill or drill-like device for fast and superior cleaning and polishing. Great for cleaning and buffing small items like mirrors, headlight lenses and trim parts. Space-age Dura-foam and fiber-sol materials make it the most durable tool of its kind. Comes in your choice of three sizes, a 2.5", 3.5" and 4.5" ball. Ideal for use with your favorite wax, polish, wheel product or compound.

K89490	2.5 inch polish ball	26.99 ea
K89491	3.5 inch polish ball	28.99 ea
K89498	4.5 inch polish ball	29.99 ea



removes oxidation, restores shine, seals and protects

- Restores Shine
- Removes Oxidation
- Seals and Protects
- For Hand or Machine Use

OEI® Extreme Shine Premium Metal Polish & Sealant

OEI® Extreme Shine Metal Polish & Sealant cuts through layers of dulling oxides to restore a wet-mirror like finish that outshines chrome. This outstanding polish makes chrome, copper, brass, aluminum, stainless steel and other metalwork gleam and look their absolute best. Spreads on with ease, buffs off with little effort. Great for oxidized metals and even light rust. Can be easily applied in the shade or sun. Leaves virtually no smear, dust or powder. The most innovative metal polish ever. A 3-step product in one, this diminishing metal polish cuts fast, cleans like no other, shines like a mirror and protects like a sealant.

Utilizing friction and heat OEI® Extreme Shine Metal Polish cleans, restores, revives and polishes. Friction generates heat that allows the product to break down into a micro-fine polish that leaves the surface shining like a mirror. During the final phase, it breaks down to release the durable protective sealant that bonds to metal surfaces reducing corrosion and prolonging shine. Use by hand with a polisher or with your polish ball & drill. K89483 16 oz. bottle..... 17.99 ea

STEERING, SUSPENSION, REAR END & BRAKES

Accessories & Firestone Tires



Tire Size Quick Reference Chart

This chart allows you, the car owner, to cross-reference the original tire size (listed in the owners manual of your vehicle) with today's "modern" metric-sizing. No more guessing!

Pre 64	65-72	80 series metric	alpha numeric 70 series	P metric 75 series radial	P metric 70 series radial
500-13	600-13	165-13	A78-13	P165/75R13	P175/70R13
640-13	650-13	175-13	B78-13	P175/75R13	P185/70R13
725-13	700-13	185-13	D78-13	P185/75R13	P205/70R13
590-14	645-14	155-14	B78-14	P175/75R14	P185/70R14
650-14	695-14	175-14	C78-14	P185/75R14	P195/70R14
700-14	735-14	185-14	E78-14	P195/75R14	P205/70R14
750-14	775-14	195-14	F78-14	P205/75R14	P215/70R14
800-14	825-14	205-14	G78-14	P215/75R14	P225/70R14
850-14	855-14	215-14	H78-14	P225/75R14	P235/70R14
590-15	600-15	165-15	A78-15	P165/75R15	P175/70R15
650-15	685-15	175-15	C78-15	P175/75R15	P185/70R15
640-15	735-15	185-15	E78-15	P195/75R15	P205/70R15
670-15	775-15	195-15	F78-15	P205/75R15	P215/70R15
710-15	815-15	205-15	G78-15	P215/75R15	P225/70R15
760-15	855-15	215-15	H78-15	P225/75R15	P235/70R15
800-15	885-15	230-15	J78-15	P225/75R15	P235/70R15
820-15	900-15	235-15	L78-15	P235/75R15	P255/70R15

OER® Mirror Shine Metal Polish

OER® Secret Formula Mirror Shine Metal Polish cuts through layers of dulling oxides, brake dust and oily soils to expose bright, shiny metal surfaces. This outstanding polish makes chrome, copper, brass, aluminum, stainless steel and other metalwork gleam and look their best. This outstanding polish will make your metalwork gleam and look its absolute best. Spreads on with ease and buffs off with little effort. Great for oxidized metals and even light rust. Can be easily applied in the shade or sun. Leaves virtually no smear, dust or powder. Use by hand, with a polisher or with your polish ball and drill. Made with aluminum oxide.



K89483 12 oz. bottle 17.99 ea
K89816 applicators..... 34.99 ea

OER® Acid Free Wheel & Tire Cleaner

Spray on and rinse off! Easily removes deposits of brake dust, grease, and road grime from wheels. Safe for clear coated, painted, and polished finishes. This strong non-acid formula is fortified with a citrus cleaning agent. This is an industrial strength 1:1 concentrate. Dilute with water according to need. Long time accumulations of brake dust may need light agitation with a soft brush. Unlike many alternative products, OER® Acid Free Wheel Cleaner dissolves grime and brake dust without damaging your chrome and alloy wheels. Non-acidic, spray-on wipe-off formula with no scrubbing necessary and no-harsh scent.



K89614 32 oz. bottle 17.99 ea
K89615 1 gallon 34.99 ea

OER® TNT Extended Life Tire & Trim Dressing

This unique formula quickly penetrates rubber trim and tires to hydrate and provide lasting protection. TNT Extended Life gel by OER® finally delivers on that promise. Simply wipe on using a pad and TNT gel restores the look of faded tires, trim, bumpers, seals and weatherstrip. What's more is that OER® TNT gel lasts for many months not days. Our exclusive no streak, no run and non drip formula works to repel water and detergents and helps keep tire walls hydrated and supple as well as looking bank spanking new. Prepare your trim for a product unlike any other, a true premium trim restorer and protectant, that will not drip, dry out or destroy surfaces. Provides unmatched durability, ease of application and a superior "new look" shine that lasts through numerous washes. Non greasy, non tacky and simply amazing.



K89816 32 oz. bottle 22.99 ea
K89817 1 gallon 49.99 ea
K89816 applicators..... 5.99 ea

Firestone Wide Oval tires are back! These tires are manufactured from the original molds to bring you the highest quality muscle car tire available. These tires were installed by Chrysler on many popular muscle cars. Each tire features a 2+2 construction (2-ply polyester and 2-ply fiberglass). Available in Raised White Lettering, featuring the words "Firestone" and "Wide O Oval", Red Lines or pinstripe whitewall. After all, if you're going to invest hard-earned money in new tires, why not increase the value of your Mopar by installing original style tires? You can see the difference!

Note: Prices must be pre-paid. Special shipping rate applies. No further discounts apply.

- Exact Reproduction of the original Firestone® Tires
- Manufactured from original molds!
- Three styles to choose from!
- Produced in the USA!
- Large Inventory for Fast Delivery!



Part Number	Tire Size	Description	Road Width	Gross Sect.	Outer Dia.	Price
T54640	D70 x 14	raised white letter	6.21"	7.85"	25.32"	209.99 ea
T54650	D70 x 14	pinstripe	6.21"	7.85"	25.32"	209.99 ea
T54670	E70 x 14	raised white letter	6.38"	8.05"	25.76"	209.99 ea
T54680	E70 x 14	pinstripe	6.38"	8.05"	25.76"	209.99 ea
T54850	F70 x 14	raised white letter	6.67"	8.30"	26.24"	209.99 ea
T54860	F70 x 14	pinstripe	6.67"	8.30"	26.24"	209.99 ea
T55250	G70 x 14	raised white letter	6.92"	8.75"	26.82"	229.99 ea
T55260	G70 x 14	pinstripe	6.92"	8.75"	26.82"	229.99 ea
T62450	F70 x 15	raised white letter	6.71"	8.35"	26.94"	239.99 ea
T62460	F70 x 15	pinstripe	6.71"	8.35"	26.94"	239.99 ea
T62480	F60 x 15	raised white letter	8.75"	9.20"	25.94"	289.99 ea
T54690	E70 x 14	red line (wide track)	6.38"	8.05"	25.76"	209.99 ea
T54870	F70 x 14	red line (wide track)	6.67"	8.30"	26.24"	209.99 ea
T55270	G70 x 14	red line (wide track)	6.92"	8.75"	26.82"	229.99 ea
T54660	D70 x 14	red line (wide track)	6.21"	7.85"	25.32"	209.99 ea
T62470	F70 x 15	red line (wide track)	6.71"	8.35"	26.94"	239.99 ea

BFGoodrich® Silvertown® Radials

- ✓ 14 & 15 inch rim diameters available
- ✓ 65 to 75 series available
- ✓ Clean smooth whitewall
- ✓ S speed rated (112 mph)
- ✓ All season tread
- ✓ High tech tread design
- ✓ Actual whitewall tire, whitewall is not ground in or added on
- ✓ 3/8" raised redline
- ✓ Backed by our life of the tread warranty
- ✓ US DOT - approved for all US highways
- ✓ ECE approved - meets or exceeds all requirements for the European community



BFGoodrich
Tires



Note: Tires must be pre-paid. Special shipping rate applies. No further discounts apply.

Tire Size	Description	Construction	Tread Width	Cross Sect.	Overall Diameter	Price
P20570R14RL	3/8 - Redline	Poly/Steel	5.80	8.00	26.10	234.99 ea
P21570R14RL	3/8 - Redline	Poly/Steel	6.40	8.70	25.90	239.99 ea
P22570R14RL	3/8 - Redline	Poly/Steel	6.70	8.90	26.30	249.99 ea
P21570R15RL	3/8 - Redline	Poly/Steel	6.40	8.70	26.90	239.99 ea
P22570R15RL	3/8 - Redline	Poly/Steel	6.70	9.00	27.40	249.99 ea
P23570R15RL	3/8 - Redline	Poly/Steel	7.00	9.50	28.00	259.99 ea
P21570R14WL	3/8 - Whiteline	Poly/Steel	6.40	8.70	25.90	239.99 ea
P21570R15WL	3/8 - Whiteline	Poly/Steel	6.40	8.70	26.90	259.99 ea
P22570R15WL	3/8 - Whiteline	Poly/Steel	6.70	9.00	27.40	289.99 ea

BFGoodrich® T/A® Radials

- ✓ Made in the USA
- ✓ 14 & 15 inch rim diameters available
- ✓ S Speed rated (112 mph)
- ✓ All season tread design
- ✓ US DOT approved for all US highways
- ✓ ECE approved - meets or exceeds all requirements within the European community



Tire Size	Recom. Rim Width	Cross Sect.	Overall Dia.	Price
P20570R14T	5.0-7.0	8.2	25.4	129.99 ea
P21560R14T	6.0-7.5	8.7	24.2	129.99 ea
P21570R14T	5.5-7.0	8.7	25.9	124.99 ea
P22560R14T	6.0-8.0	9.0	24.7	114.99 ea
P22570R14T	6.0-7.5	9.0	26.5	129.99 ea
P23560R14T	6.5-8.5	9.5	25.1	134.99 ea
P24560R14T	7.0-8.5	9.8	25.6	144.99 ea
P19560R15T	5.5-7.0	7.9	24.2	99.99 ea
P20560R15T	5.5-7.5	8.2	24.7	114.99 ea
P21560R15T	6.0-7.5	8.7	25.2	134.99 ea
P21565R15T	6.0-7.5	8.7	26.0	129.99 ea
P21570R15T	5.5-7.0	8.7	26.9	119.99 ea
P22560R15T	6.0-8.0	9.0	25.6	129.99 ea
P22570R15T	6.0-7.5	9.0	27.4	134.99 ea
P23560R15T	6.5-8.5	9.5	26.1	139.99 ea
P23570R15T	6.0-8.0	9.5	28.0	134.99 ea
P24560R15T	7.0-8.5	9.8	26.6	144.99 ea
P25560R15T	7.0-9.0	10.2	27.1	154.99 ea

Note: Tires must be pre-paid. Special shipping rate applies. No further discounts apply.

BFGoodrich
Tires

Goodyear® Polyglas Tires

Give your Mopar a correct appearance by replacing your tires with original Goodyear quality! Goodyear is the tire Chrysler chose for many late model 1960's and early model 1970's high performance vehicles. Goodyear is a registered trademark of The Goodyear Tire Corporation.

- O** Perfect for late model 1960's and early model 1970's Mopar muscle cars!
- E** The Goodyear® name means quality and dependability!
- M** Increase the value of your project while maintaining originality!



Goodyear® is known throughout the automotive industry as one of the finest quality tires manufactured! And now Goodyear® proudly offers these high quality replacements utilizing the original molds for authenticity and quality! The Goodyear tires are produced with exact specifications offering the highest quality while maintaining complete originality! Many of Chrysler's late 1960's and early 1970's muscle cars or high performance vehicles included the Goodyear® raised white letter Polyglas or white line Polyglas tires. Make your project complete by adding the one item that so many restorers neglect. Original tires are a great investment

and increase the value of your Mopar! Now you can own the original Raised White Letter Polyglas Goodyear® tires. Utilizing the same molds as the originals, you know you can count on their Goodyear® quality. Perfect for Rallye Wheels! These tires can obviously be installed on virtually any early model Mopar. These tires were standard equipment for many Chrysler high performance vehicles of the late model 1960's and early 1970's.

Note: Tires must be pre-paid. Special shipping rate applies. No further discounts apply.



Part Number	Tire Size	Style	Description	Price
GYE7014	E70/14	Raised White Letter	Custom Wide Tread 2/2 Polyglas	209.99 ea
GYE7014R	E70/14	.350 Redline	Custom Wide Tread 2/2 Polyglas	219.99 ea
GYF7014	F70/14	Raised White Letter	Custom Wide Tread 2/2 Polyglas	219.99 ea
GYF7014R	F70/14	.350 Redline	Custom Wide Tread 2/2 Polyglas	229.99 ea
GYF7014WR	F70/14	.350 Redline	QW-1 4 Ply Poly	224.99 ea
GYG7014R	G70/14	.350 Redline	Custom Wide Tread 2/2 Polyglas	239.99 ea
GYE7015W	E70/15	Raised White Letter	QW-1 4 Ply Poly	289.99 ea
GYF7015	F70/15	Raised White Letter	Custom Wide Tread 2/2 Polyglas	239.99 ea
GYF7015R	F70/15	.350 Redline	Custom Wide Tread 2/2 Polyglas	244.99 ea
GYF7015WR	F70/15	.350 Redline	QW-1 4 Ply Poly	259.99 ea
GYF6015	F60/15	Raised White Letter	Custom Wide Tread 2/2 Polyglas GT	259.99 ea
GYG6015	G60/15	Raised White Letter	2/2 Polyglas GT	279.99 ea
GYG6015R	G60/15	.350 Redline	2/2 Polyglas GT	334.99 ea

Important: QW-1 Speedway Wide Tread.

Redline Radial Tires

Classic Redline Radial Tires

Redline radial tires just like the ones popularized in the 1960's! Designed to provide the appearance of an original, each tire is brand new and offers a great way to retain originality.

Important: When replacing bias ply tires with radials, please refer to the auto manufacturers recommendations. Rims designed for bias tires can crack because of the extra stress placed on them with radial tires. Interchangeability is not implied nor is it always possible because of rim sizes. Do not mix radial tires and bias tires on the same vehicle. Vehicles designed for bias tires may drive differently than was originally intended. Please use caution when installing.

Note: Tires must be pre-paid. Special shipping rate applies. No further discounts apply.

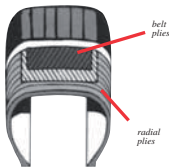

Part#	Construction	Load capacity	Tread	Section	Dia.	Price
P20575R14R	Poly/Steel	1532@ 35 psi	5.68"	8.14"	26.11"	244.99 ea

OER Replacement Radiators

OER AUTHORIZED



MB2370A



MA2249S

1962-76 Reproduction Radiators

OER® Authorized reproduction radiators for various 1962-76 models. These radiators are manufactured completely from durable copper materials and are designed to meet the cooling needs of stock small and big block engines. Will install without modifying your radiator support or support top panel. Features 1/2" tubes on 9/16" centers. Available in 3 or 4 rows. Made in USA.

Note: Please add (A) to the end of the part number for automatic transmission and (S) for manual transmission. Shipped oversize.

3 Row Core

A-Body Models	1965-66	170/225	17-1/2" x 22"	359.99 ea
MA2240	1965-66	small block	17-1/2" x 22"	359.99 ea
MA2241	1963-66	small block	16-1/4" x 22"	359.99 ea
MA2242	1965	273	16-1/4" x 22"	359.99 ea
MA2243	1966	170/225	17-1/4" x 22"	359.99 ea
MA2244	1966	273	17-1/4" x 22"	359.99 ea
MA2245	1967-69	170/225	17-1/2" x 22"	359.99 ea
MA2246	1967-69	small block	17-1/2" x 22"	359.99 ea
MA2247	1967-69	big block	17-1/2" x 22"	359.99 ea
MA2248	1970-72	198/225	17" x 22"	359.99 ea
MA2249	1970-72	318/340	17" x 22"	359.99 ea
MA2250	1973	198/225	17" x 22"	419.99 ea
MA2251	1973	318/340	17" x 22"	359.99 ea
MA2252	1973-76	318/340/360	18" x 25-3/8"	359.99 ea

B-Body Models	1962-64	225	18-1/8" x 22"	359.99 ea
MB2359	1962-64	225	18-1/8" x 22"	359.99 ea
MB2360	1962-64	318	18-1/8" x 22"	359.99 ea
MB2361	1962-64	361/383/413/426	18-1/8" x 22"	359.99 ea
MB2362	1963-64	225	18-1/8" x 22"	359.99 ea
MB2363	1963-64	318	18-1/8" x 22"	359.99 ea
MB2364	1963-64	361/383/426	18-1/8" x 22"	359.99 ea
MB2365	1963-65	318	18-1/8" x 22"	359.99 ea
MB2366	1963-65	361/383/426	18-1/8" x 22"	359.99 ea
MB2367	1966-69	small block	18-1/8" x 22"	359.99 ea
MB2368	1966-69	small block	17-1/2" x 26"	359.99 ea
MB2369	1966-69	big block	18-1/8" x 22"	359.99 ea
MB2370	1966-69	big block	17-1/2" x 26"	359.99 ea
MB2371	1966-69	426 Hemi	18-1/8" x 22"	359.99 ea

B & E Body Models	1971-73	196/225	17-7/8" x 22"	359.99 ea
MD2286	1971-73	196/225	17-7/8" x 22"	359.99 ea
MD2287	1970-72	small block	17-1/2" x 26"	359.99 ea
MD2288	1970-72	small block	17-1/2" x 26"	359.99 ea
MD2289	1970-72	big block	18-1/8" x 22"	359.99 ea
MD2290	1970-72	big block	17-1/2" x 26"	359.99 ea
MD2291	1973	small block	18-1/8" x 22"	359.99 ea
MD2292	1973	small block	17-1/2" x 26"	359.99 ea
MD2293	1973	big block	18-1/8" x 22"	359.99 ea
MD2294	1973	big block	17-1/2" x 26"	359.99 ea

4 Row Core

A-Body Models	1965-66 <th>small block <th>17-1/2" x 22"</th> <th>399.99 ea</th> </th>	small block <th>17-1/2" x 22"</th> <th>399.99 ea</th>	17-1/2" x 22"	399.99 ea
MA2253	1965-66	small block	17-1/2" x 22" <td>399.99 ea</td>	399.99 ea
MA2254	1965	273	16-1/4" x 22"	399.99 ea
MA2255	1966	170/225	17-1/4" x 22"	399.99 ea
MA2256	1966	273	17-1/4" x 22"	399.99 ea
MA2257	1967-69	170/225	17-1/2" x 22"	399.99 ea
MA2258	1967-69	small block	17-1/2" x 22"	399.99 ea
MA2260	1970-72	198/225	17" x 22"	399.99 ea
MA2261	1970-72	318/340	17" x 22"	399.99 ea
MA2262	1973	198/225	17" x 22"	399.99 ea
MA2263	1973	318/340	17" x 22"	399.99 ea
MA2264	1973-76	318/340/360	18" x 25-3/8"	399.99 ea

B-Body Models	1962-64	225 <th>18-1/8" x 22"</th> <th>399.99 ea</th>	18-1/8" x 22"	399.99 ea
MB2372	1962-64	225	18-1/8" x 22"	399.99 ea
MB2373	1962-64	318	18-1/8" x 22"	399.99 ea
MB2374	1962-64	361/383/413/426	18-1/8" x 22"	399.99 ea
MB2375	1963-64	225	18-1/8" x 22"	399.99 ea

B-Body Models - continued

MB2376	1963-64	318	18-1/8" x 22"	399.99 ea
MB2377	1963-64	361/383/426	18-1/8" x 22"	399.99 ea
MB2378	1963-65	318	18-1/8" x 22"	399.99 ea
MB2379	1963-65	361/383/426	18-1/8" x 22"	399.99 ea
MB2380	1966-69	small block	18-1/8" x 22"	399.99 ea
MB2381	1966-69	small block	17-1/2" x 26"	399.99 ea
MB2382	1966-69	big block	18-1/8" x 22"	399.99 ea
MB2383	1966-69	big block	17-1/2" x 26"	399.99 ea
MB2384	1966-69	426 Hemi	18-1/8" x 22"	399.99 ea

B & E Body Models

MD2295	1970-72	small block	17-7/8" x 22"	399.99 ea
MD2296	1970-72	small block	17-1/2" x 26"	399.99 ea
MD2297	1970-72	big block	18-1/8" x 22"	399.99 ea
MD2298	1970-72	big block	17-1/2" x 26"	399.99 ea
MD2299	1973	small block	18-1/8" x 22"	399.99 ea
MD2300	1973	small block	17-1/2" x 26"	399.99 ea
MD2301	1973	big block	18-1/8" x 22"	399.99 ea
MD2302	1973	big block	17-1/2" x 26"	399.99 ea

1963-74 Polished Aluminum Radiators



These polished high performance radiators are manufactured from tig welded aircraft grade aluminum with brazed aluminum cores and biller filler necks. Each radiator offers high capacity cooling with lowered fins and 3/8" spacing between core tubes. Designed for direct fit installation. Radiator cap is included.

Important: All radiators have built in automatic transmission coolers and can be used in both automatic and manual transmission applications. Core size dimensions listed below.

*Note: *Offset inlet. Shipped oversize.*



MP600122

2 Row Core

A-Body Models	1965-66	17-1/2" x 22" x 1-3/4"	LH in LH out	169.99 ea
MP600120	1965-66	17-1/2" x 22" x 1-3/4"	LH in LH out	169.99 ea
MP600121	1968-73	16-1/4" x 26" x 1-3/4"	LH in RH out	169.99 ea
MP600122	1968-73	17-1/2" x 26-1/8" x 1-3/4"	RH in LH out	169.99 ea
MP600123	1970-72	16-3/8" x 22-3/4" x 1-3/4"	RH in LH out	169.99 ea
MP600124	1970-73	15-7/8" x 21-1/2" x 1-3/4"	LH in RH out	169.99 ea

B-Body Models	1970-72 <th>16-3/8" x 22-3/4" x 1-3/4"</th> <th>RH in LH out</th> <th>169.99 ea</th>	16-3/8" x 22-3/4" x 1-3/4"	RH in LH out	169.99 ea
MP600123	1970-72	16-3/8" x 22-3/4" x 1-3/4"	RH in LH out	169.99 ea
MP600124	1970-73	15-7/8" x 21-1/2" x 1-3/4"	LH in RH out	169.99 ea
MP600121	1970-74	16-1/4" x 26" x 1-3/4"	LH in RH out	169.99 ea
MP600122	1970-74	17-1/2" x 26-1/8" x 1-3/4"	RH in LH out	169.99 ea

3 Row Core

A-Body Models	1964	16-3/4" x 19" x 2"	RH in LH out	219.99 ea
MP600125	1964	16-3/4" x 19" x 2"	RH in LH out <td>219.99 ea</td>	219.99 ea
MP600126	1965-66	17-1/2" x 22" x 2"	LH in LH out <td>219.99 ea</td>	219.99 ea
MP600127	1970-72	17" x 22-1/2" x 2-1/4"	LH in RH out <td>219.99 ea</td>	219.99 ea

B-Body Models	1963-69	17-1/2" x 22" x 2"	LH in LH out	219.99 ea
MP600126*	1963-69	17-1/2" x 22" x 2"	LH in LH out	219.99 ea
MP600128	1966-69	17-1/2" x 26" x 2"	RH in LH out	219.99 ea
MP600129	1966-69	17-1/2" x 26" x 2-1/8"	LH in LH out	219.99 ea
MP600130	1968-73	16-1/4" x 26" x 2-1/2"	RH in LH out	219.99 ea
MP600131	1968-73	17-1/2" x 26-1/8" x 2-1/2"	LH in LH out	219.99 ea
MP600132	1970-72	16-3/8" x 22-3/4" x 2-1/2"	RH in LH out	219.99 ea
MP600133	1970-73	15-7/8" x 21-1/2" x 2-1/2"	LH in RH out	219.99 ea
MP600134	1970-74	16-1/4" x 26" x 2-1/2"	LH in RH out	219.99 ea
MP600131*	1970-74	17-1/2" x 26-1/8" x 2-1/2"	RH in LH out	219.99 ea

B-Body Models	1970-72 <th>16-3/8" x 22-3/4" x 2-1/2"</th> <th>RH in LH out</th> <th>219.99 ea</th>	16-3/8" x 22-3/4" x 2-1/2"	RH in LH out	219.99 ea
MP600132	1970-72	16-3/8" x 22-3/4" x 2-1/2"	RH in LH out <td>219.99 ea</td>	219.99 ea
MP600133	1970-73	15-7/8" x 21-1/2" x 2-1/2"	LH in RH out	219.99 ea
MP600134	1970-74	16-1/4" x 26" x 2-1/2"	LH in RH out	219.99 ea
MP600131	1970-74	17-1/2" x 26-1/8" x 2-1/2"	RH in LH out	219.99 ea

4 Row Core

A-Body Models	1968-73	16-1/4" x 26" x 2-3/4"	RH in LH out	289.99 ea
MP600135	1968-73	16-1/4" x 26" x 2-3/4"	RH in LH out	289.99 ea
MP600137	1970-72	17-1/2" x 26" x 2-3/4"	LH in LH out	289.99 ea
MP600138	1970-72	16-3/8" x 22-3/4" x 2-3/4"	RH in LH out	289.99 ea
MP600139	1970-74	16-1/4" x 26" x 2-3/4"	LH in RH out	289.99 ea
MP600136	1970-74	17-1/2" x 26-1/8" x 2-3/4"	RH in LH out	289.99 ea

AC, HEATER & COOLING SYSTEM

Aluminum Radiators

AUTHORIZED

1963-73 Aluminum Radiators

Aluminum reproduction radiators for various 1963-73 models. These 2 row radiators are manufactured completely from durable aluminum and are designed to meet the cooling needs of high performance big and small block engines. Will bolt in without modifying your radiator support or support top panel, this radiator offers better heat transfer and is considerably lighter than standard replacement radiators. Made in USA.

Note: Please add (A) to the end of the part number for automatic transmission and (S) for manual transmission. Shipped overseas.

A-Body - 2 Row Core

Core Size 16-1/4" x 22"		
MA2235	1965	273.....399.99 ca
Core Size 17-3/4" x 22"		
MA2236	1967-69	273/318/340.....399.99 ca
MA2237	1967-69	383.....399.99 ca
MA2238	1970-72	318/340.....399.99 ca
MA2239	1973	318/340.....399.99 ca

B-Body - 2 Row Core

Core Size 17-3/4" x 22"		
MB2352	1963-64	318.....399.99 ca
MB2353	1963-64	361/383/426.....399.99 ca
MB2354	1963-64	L6 225.....399.99 ca
MB2355	1966-69	318/340.....399.99 ca
MB2356	1966-69	383/426/440.....399.99 ca
Core Size 17-3/4" x 26"		
MB2357	1966-69	318/340.....399.99 ca
MB2358	1966-69	383/426/440.....399.99 ca

B & E-Body - 2 Row Core

Core Size 17-1/2" x 26"		
MD2266	1973	small block.....399.99 ca
MD2265	1973	big block.....399.99 ca
Core Size 17-3/4" x 26"		
MD2262	1970-72	small block.....399.99 ca
MD2261	1970-72	big block.....399.99 ca
Core Size 18-1/8" x 22"		
MD2260	1970-72	small block.....399.99 ca
MD2264	1973	small block.....399.99 ca
MD2259	1970-72	big block.....399.99 ca
MD2263	1973	big block.....399.99 ca

1961-76 AFco Aluminum Radiators

The 100% aluminum construction uses no epoxy, making these direct fit radiators durable and up to 15% more efficient than copper/brass radiators. These radiators fit in the original location using the factory fan shroud, and the inlet and outlet are in the stock locations so OE-style radiator hoses can be used. Automatic versions feature a built in transmission cooler designed to use factory transmission lines.

Note: Shipped overseas.



AR84296M

A-Body

Natural Finish		
AR84296NM	1961-76	w/MT.....619.99 ca
AR84296NA	1961-76	w/AT.....699.99 ca
Black Finish		
AR84296BM	1961-76	w/MT.....799.99 ca
AR84296BA	1961-76	w/AT.....884.99 ca
Polished Finish		
AR84296PM	1961-76	w/MT.....859.99 ca
AR84296PA	1961-76	w/AT.....949.99 ca

1961-76 A, B & E-Body Direct-fit Radiators - Cont'd

B-Body

Natural Finish		
AR84295NM	1962-76	w/MT.....619.99 ca
AR84295NA	1962-76	w/AT.....699.99 ca
Black Finish		
AR84295BM	1962-76	w/MT.....799.99 ca
AR84295BA	1962-76	w/AT.....884.99 ca
Polished Finish		
AR84295PM	1962-76	w/MT.....859.99 ca
AR84295PA	1962-76	w/AT.....949.99 ca

E-Body

Natural Finish		
AR84295NM	1970-74	w/MT.....619.99 ca
AR84295NA	1970-74	w/AT.....699.99 ca
Black Finish		
AR84295BM	1970-74	w/MT.....799.99 ca
AR84295BA	1970-74	w/AT.....884.99 ca
Polished Finish		
AR84295PM	1970-74	w/MT.....859.99 ca
AR84295PA	1970-74	w/AT.....949.99 ca

1966-74 Northern Aluminum Radiators

This high performance bolt-in radiator from Northern[®] is manufactured with race-proven technology. These aluminum radiators feature a two-row, 1" core tube design for maximum cooling efficiency. Northern[®] fan and shroud assemblies are also available for a matched cooling system.

Important: Dimensions listed include the radiator, tanks and brackets.

Note: Shipped overseas.

- Bolt-In Installation
- 60% Lighter Than Copper/Brass
- Up to 75% More Cooling Capacity
- Fully Welded Construction
- Size: 28" x 18-1/2" x 3-1/8"
- Heavy Duty, Oil-Stamped Tanks
- Extra Thick Hose Connections
- Billet Filter Neck
- 7 Plate Alum. Transmission Cooler



CR5070

A-Body

Dart		
CR5070	1970-73	318, 340.....259.99 ca
CR5071	1974-76	318, 360.....249.99 ca

B-Body

Belvedere		
CR5070	1970	318.....259.99 ca
CR5071	1970	383, 440.....249.99 ca
Charger		
CR5071	1966-69	all V8.....249.99 ca
CR5071	1970-71	383, 440, 426.....249.99 ca
CR5070	1970-71	318, 340.....259.99 ca
CR5071	1972-73	400, 440.....249.99 ca
CR5070	1972-73	318, 340.....259.99 ca
CR5071	1974	318, 360.....249.99 ca
CR5070	1974	400, 440.....259.99 ca
Coronet		
CR5070	1970-71	400, 440, 426.....249.99 ca
CR5070	1970-73	318, 340.....259.99 ca
CR5070	1972-74	400, 440.....259.99 ca
CR5070	1974	318, 360.....259.99 ca
Sate-lite		
CR5070	1970	318.....259.99 ca
CR5071	1970-71	383, 440.....249.99 ca

E-Body

Barracuda		
CR5071	1970	383, 426, 440.....249.99 ca
CR5070	1970-71	318, 340.....259.99 ca
CR5071	1971	383, 440.....249.99 ca
CR5071	1972	400, 440.....249.99 ca
Challenger		
CR5071	1970-71	383, 400, 426.....249.99 ca
CR5071	1972	400, 440.....249.99 ca
CR5070	1970-74	318, 360.....259.99 ca

New!



Northern

Northern Aluminum Fan Shroud Kits

Northern do-it-yourself fan shroud kits are an excellent way to get a custom fitted fan shroud for your radiator and engine driven fan! Designed to fit most stock or aftermarket radiators. Manufactured from .063" lightweight aircraft aluminum. Features an adjustable collar for 15" to 20" fan diameters. Made in USA.

Note: Shipped overseas.

Universal Fan Shroud

Z40031	18-3/8" x 22" x 2-5/8"59.99 kit
--------	------------------------	----------------

New!



SILLA

SR009621



SR003740

1968-76 Economy Aluminum Radiators

These quality light weight aluminum radiators stand up to the demands of everyday driving with excellent cooling properties. These replacement radiators vary in appearance from the originals, but fit in the factory mounting locations and work with original fan shrouds. Every radiator includes fittings for an automatic transmission cooler.

Important: The core is slightly smaller than the original; this will not lessen cooling capabilities. Measure your core. Hose adapters are included.

Note: Shipped overseas.

1 Row Core

1966-74 B-Body		
SR005110	7-7/8" x 21-1/8" x 1-1/4"159.99 ca
1974-76 B-Body		
SR009621	26-3/8" x 18-3/4" x 1-1/4"159.99 ca
1970-74 E-Body		
SR005110	17-7/8" x 21-1/8" x 1-1/4"159.99 ca

2 Row Core

1967-76 A-Body		
SR005272	17" x 22" x 1-1/4"159.99 ca
1973-76 A-Body		
SR004991	18" x 25-3/8" x 1-1/4"179.99 ca
SR004992	18" x 25-3/8" x 1-1/4"159.99 ca

1970-72 B & E-Body

SR003750	17-1/2" x 25-3/8" x 1-3/4"214.99 ca
SR003752	17-1/2" x 26-1/4" x 1-3/4"279.99 ca
1970-74 B & E-Body		
SR003740	17-1/2" x 25" x 1-3/4"204.99 ca

3 Row Core

1970-72 B & E-Body		
SR003751	17-1/2" x 25-3/8" x 2-1/8"234.99 ca

Be Cool Radiators



BC62174



1980-76 Be Cool Direct-Fit Aluminum Cross-Flow Conversion Radiators

Nothing takes the fun out of driving your Mopar like overheating. That's why you need a cooling system that can keep up with your engine, especially when your engine has been upgraded. Stock radiators are designed to cool stock applications and often fail to keep up with high-performance applications. Be Cool produces cross-flow radiators that are 40% lighter than conventional OEM units with greater cooling capacity, thanks to epoxy-free construction. Available with natural or polished finish. Made in the USA.

Important: Modification to Upper and Lower Hoses and Transmission lines required for Crossflow upgrade.

Note: * Replaces OEM downflow radiator with a 26" core. Four brackets needed (Part Number BC72003) to install stock OEM fan shroud.

** Modification to top mounting plate for crossflow conversion may be required. Shipped oversize. No further discounts apply.



A-Body - Natural Finish

Small Block - 26" W x 19" H Overall Dimensions			
BC62038*	1960-76	AT, with LH water pump outlet	664.99 ea
BC62016*	1960-76	AT, with RH water pump outlet	639.99 ea
BC60038*	1960-76	MT, with LH water pump outlet	539.99 ea
BC60016*	1960-76	MT, with RH water pump outlet	539.99 ea
All Engines - 30" W x 19" H Overall Dimensions			
BC62174**	1964-76	AT, with LH water pump outlet	791.99 ea
BC62175**	1964-76	AT, with RH water pump outlet	791.99 ea
BC60174**	1964-76	MT, with LH water pump outlet	759.99 ea
BC60175**	1964-76	MT, with RH water pump outlet	759.99 ea
All Engines - 33" W x 19" H Overall Dimensions			
BC62198**	1964-76	AT, with LH water pump outlet	874.99 ea
BC62199**	1964-76	AT, with RH water pump outlet	874.99 ea
BC60198**	1964-76	MT, with LH water pump outlet	759.99 ea
BC60199**	1964-76	MT, with RH water pump outlet	759.99 ea

A-Body - Polished Finish

Small Block - 26" W x 19" H Overall Dimensions			
BC63038*	1960-76	AT, with LH water pump outlet	799.99 ea
BC63016*	1960-76	AT, with RH water pump outlet	799.99 ea
BC61038*	1960-76	MT, with LH water pump outlet	759.99 ea
BC61016*	1960-76	MT, with RH water pump outlet	759.99 ea
All Engines - 30" W x 19" H Overall Dimensions			
BC63174**	1964-76	AT, with LH water pump outlet	959.99 ea
BC63175**	1964-76	AT, with RH water pump outlet	959.99 ea
BC61174**	1964-76	MT, with LH water pump outlet	859.99 ea
BC61175**	1964-76	MT, with RH water pump outlet	859.99 ea
All Engines - 33" W x 19" H Overall Dimensions			
BC63198**	1964-76	AT, with LH water pump outlet	959.99 ea
BC63199**	1964-76	AT, with RH water pump outlet	959.99 ea
BC61198**	1964-76	MT, with LH water pump outlet	959.99 ea
BC61199**	1964-76	MT, with RH water pump outlet	959.99 ea

B-Body - Natural Finish

Small Block - 26" W x 19" H Overall Dimensions			
BC62038*	1960-76	AT, with LH water pump outlet	664.99 ea
BC62016*	1960-76	AT, with RH water pump outlet	639.99 ea
BC60038*	1960-76	MT, with LH water pump outlet	539.99 ea
BC60016*	1960-76	MT, with RH water pump outlet	539.99 ea
All Engines - 29" W x 19" H Overall Dimensions			
BC62170**	1964-70	AT, with LH water pump outlet	724.99 ea
BC62171**	1964-70	AT, with RH water pump outlet	791.99 ea
BC60170**	1964-70	MT, with LH water pump outlet	709.99 ea
BC60171**	1964-70	MT, with RH water pump outlet	759.99 ea
All Engines - 33" W x 19" H Overall Dimensions			
BC62172**	1964-70	AT, with LH water pump outlet	791.99 ea
BC62173**	1964-70	AT, with RH water pump outlet	791.99 ea
BC60172**	1964-70	MT, with LH water pump outlet	759.99 ea
BC60173**	1964-70	MT, with RH water pump outlet	759.99 ea
All Engines - 29" W x 19" H Overall Dimensions			
BC62186*	1971-74	AT, with LH water pump outlet	874.99 ea
BC62286*	1971-74	AT, with RH water pump outlet	791.99 ea
BC60186**	1971-74	MT, with LH water pump outlet	759.99 ea
BC60286**	1971-74	MT, with RH water pump outlet	759.99 ea

B-Body - Polished Finish

Small Block - 26" W x 19" H Overall Dimensions			
BC63038*	1960-76	AT, with LH water pump outlet	799.99 ea
BC63016*	1960-76	AT, with RH water pump outlet	799.99 ea
BC61038*	1960-76	MT, with LH water pump outlet	759.99 ea
BC61016*	1960-76	MT, with RH water pump outlet	759.99 ea
All Engines - 29" W x 19" H Overall Dimensions			
BC63170**	1964-70	AT, with LH water pump outlet	959.99 ea
BC63171**	1964-70	AT, with RH water pump outlet	959.99 ea
BC61170**	1964-70	MT, with LH water pump outlet	859.99 ea
BC61171**	1964-70	MT, with RH water pump outlet	859.99 ea
All Engines - 33" W x 19" H Overall Dimensions			
BC63172**	1964-70	AT, with LH water pump outlet	959.99 ea
BC63173**	1964-70	AT, with RH water pump outlet	959.99 ea
BC61172**	1964-70	MT, with LH water pump outlet	859.99 ea
BC61173**	1964-70	MT, with RH water pump outlet	859.99 ea
All Engines - 29" W x 19" H Overall Dimensions			
BC63186**	1971-74	AT, with LH water pump outlet	959.99 ea
BC63286**	1971-74	AT, with RH water pump outlet	959.99 ea
BC61186**	1971-74	MT, with LH water pump outlet	959.99 ea
BC61286**	1971-74	MT, with RH water pump outlet	799.99 ea

E-Body - Natural Finish

Small Block - 26" W x 19" H Overall Dimensions			
BC62038*	1970-74	AT, with LH water pump outlet	664.99 ea
BC62016*	1970-74	AT, with RH water pump outlet	639.99 ea
BC60038*	1970-74	MT, with LH water pump outlet	539.99 ea
BC60016*	1970-74	MT, with RH water pump outlet	539.99 ea
All Engines - 29" W x 19" H Overall Dimensions			
BC62178**	1970-74	AT, with LH water pump outlet	791.99 ea
BC62179**	1970-74	AT, with RH water pump outlet	791.99 ea
BC60178**	1970-74	MT, with LH water pump outlet	759.99 ea
BC60179**	1970-74	MT, with RH water pump outlet	759.99 ea
All Engines - 33" W x 19" H Overall Dimensions			
BC62176**	1970-74	AT, with LH water pump outlet	791.99 ea
BC62177**	1970-74	AT, with RH water pump outlet	791.99 ea
BC60176**	1970-74	MT, with LH water pump outlet	759.99 ea
BC60177**	1970-74	MT, with RH water pump outlet	759.99 ea
6.1 Hemi - 29" W x 19" H Overall Dimensions			
BC62264	1970-74	AT, with RH water pump outlet	749.99 ea
BC60264	1970-74	MT, with RH water pump outlet	799.99 ea

E-Body - Polished Finish

Small Block - 26" W x 19" H Overall Dimensions			
BC63038*	1970-74	AT, with LH water pump outlet	799.99 ea
BC63016*	1970-74	AT, with RH water pump outlet	799.99 ea
BC61038*	1970-74	MT, with LH water pump outlet	759.99 ea
BC61016*	1970-74	MT, with RH water pump outlet	759.99 ea
All Engines - 29" W x 19" H Overall Dimensions			
BC63178**	1970-74	AT, with LH water pump outlet	959.99 ea
BC63179**	1970-74	AT, with RH water pump outlet	959.99 ea
BC61178**	1970-74	MT, with LH water pump outlet	859.99 ea
BC61179**	1970-74	MT, with RH water pump outlet	859.99 ea
All Engines - 33" W x 19" H Overall Dimensions			
BC63176**	1970-74	AT, with LH water pump outlet	959.99 ea
BC63177**	1970-74	AT, with RH water pump outlet	959.99 ea
BC60176**	1970-74	MT, with LH water pump outlet	859.99 ea
BC60177**	1970-74	MT, with RH water pump outlet	859.99 ea
6.1 Hemi - 29" W x 19" H Overall Dimensions			
BC63264	1970-74	AT, with RH water pump outlet	874.99 ea
BC61264	1970-74	MT, with RH water pump outlet	799.99 ea

Radiator Components



MD2239

Authentic Restoration



MD2240

1960-74 Reproduction Radiator Caps

OE-style reproduction radiator caps for 1960-74 models. These radiator caps will fit all models equipped with 26" radiators.

MD2239 1960-69	24.99 ea
MD2240 1970-74	19.99 ea



Mopar 16 Lb. Radiator Cap

16 lb. radiator cap for all models with 22" and 26" radiators. This cap is a factory Chrysler replacement and will fit and function as original.

MN1726 16 lb. 22" & 26" radiator	19.99 ea
----------------------------------	----------



ST10329



ST10231

1960-78 Replacement Radiator Caps

Replacement radiator caps for various 1960-76 vehicles. Replace a faulty or leaking radiator cap to help your cooling system function properly.

Note: Check vehicle clearances prior to installing Lev-R-Vent cap.

A-Body

ST10329 1960-66	lev-r-vent	5.99 ea
ST10229 1960-66	regular	4.99 ea
ST10331 1967-76	lev-r-vent	5.99 ea
ST10231 1967-76	regular	4.99 ea

B-Body

ST10329 1962-66	lev-r-vent	5.99 ea
ST10229 1962-66	regular	4.99 ea
ST10331 1967-74	lev-r-vent	5.99 ea
ST10231 1967-74	regular	4.99 ea

E-Body

ST10331 1970-74	lev-r-vent	5.99 ea
ST10231 1970-74	regular	4.99 ea



MD2216



MD2215

Authentic Restoration

1974 E-Body Radiator Overflow Bottle Set

Reproduction overflow bottle set for 1974 E-Body models. Includes a correct green cap, hose clamps and two correctly ribbed and sized hoses. Available separately is the overflow bottle mounting bracket, which includes all the necessary mounting hardware.

MD2216 1974 overflow set	84.99 set
MD2215 1974 mounting bracket	109.99 ea

Authentic Restoration



1972-74 Radiator Overflow Bottle Cap

Reproduction overflow bottle cap for 1972-74 models.

Features correct green color and the two hose size fittings.	
MD2241 1973 A-Body	14.99 ea
MD2241 1972-74 B-Body	14.99 ea
MD2241 1974 E-Body	14.99 ea

Authentic Restoration



1970-74 Radiator Overflow Hose Set

Reproduction overflow bottle cap and hose set for 1970-74 models. Feature correct length and ribbed design. Set includes two hoses, clamps and a correct green cap.

MD2217 1970-74 B-Body	34.99 set
MD2217 1973-74 E-Body	34.99 set

1962-74 Radiator Overflow Hoses

Replace your cracked, missing radiator overflow hose with this aftermarket replacement overflow hose.

Measures 3' long.	
MN1830 1962-69 19" or 22" radiators	6.99 ea
MN1789 1966-69 26" radiator	7.99 ea
MN1789 1974 w/overflow tank	7.99 ea



MN1830



60761

Stainless Steel Radiator Overflow Tank

These polished stainless steel radiator overflow tanks will give your engine compartment a clean, custom look and feature a twist-on cap and mounting hardware.

60721 2" x 13"	24.99 ea
60731 2" x 15"	25.99 ea
60741 2" x 17"	39.99 ea
60751 2" x 19"	29.99 ea
60761 3" x 10"	31.99 ea
60781 3" x 16"	34.99 ea



TF600175



TF600176



TF600180



BC71003

BC72003



Be Cool Radiator Accessories

Choose the right radiator cap and recovery tank to complement your cooling system. Billet radiator caps, rated at 13 psi, are recommended for all Be Cool radiators, along with a proper coolant recovery tank, which is safer for the environment than overflow tanks. Aluminum brackets are also available to install the stock fan shroud and finish your Be Cool conversion. *Note: No further discounts apply.*

Radiator Caps

Round Style with Be Cool Logo	
TF600175 polished finish	54.99 ea
TF600178 natural finish	49.99 ea
Octagon Style with Be Cool Logo	
TF600176 polished finish	59.99 ea
TF600179 natural finish	49.99 ea
Sure Grip Style with Embossed Emblem	
TF600177 polished finish	69.99 ea
TF600180 natural finish	59.99 ea

Recovery Tanks

7" x 3" with Inlet & Mount Bracket	
BC71003 polished finish	149.99 ea
BC70003 natural finish	119.99 ea

Fan Shroud Mounting Brackets

BC72003 natural finish - 4 req.	12.99 ea
---------------------------------	----------

Radiator Fan Shrouds



1962-73 Radiator Fan Shrouds

Radiator fan shrouds produced using injection-molded urethane or steel. For various models and radiator sizes. Please refer to the applications below for the correct shroud for your vehicle. All radiator fan shrouds are designed to attach at stock radiator mounting locations.

A-Body

1968-69 V-8 Fan Shroud w/A-C— This injection molded urethane shroud is a correct replacement for 1968-69 A-Body models equipped with a 22" radiator. Including 273, 318, 340, 383 and 440 powered Darts, Valiants and Barracudas. Replaces original part # 2785614.
MA2227 1968-69..... 169.99 ea

1970-72 V-8 Fan Shroud w/A-C— Replacement V-8 fan shroud for all 1970-72 A-Body vehicles equipped with a 22" radiator including 318, 340 and 360 powered Darts, Valiants, Dusters and Demons. This injection molded urethane shroud replaces original part # 2998325.
MA2228 1970-72..... 169.99 ea

B-Body

1969 440 V-8 Fan Shroud— Correct radiator fan shroud for 1969-440 powered vehicles, including Charger, R/T models and GTX. Manufactured from injection molded urethane, this shroud will replace your damaged original. Replaces original part # 2949130. For use on 22" radiators only. *Note: May also be used for 1966-68 318, 383 and 440 powered B-Body models in conjunction with the MD2224 Fan Shroud Mounting Bracket Kit when used in place of original equipment radiators that would normally use a steel shroud.*
MB2340 1969..... 164.99 ea

1962-68 Steel Fan Shroud— Radiator steel fan shroud for all 1962-68 B-Body vehicles, equipped with V-8 small or big block. This two piece unit features the correct fan opening lip, hose reliefs, the top and bottom stiffeners are spot welded like original and it's finished in a powder coated low gloss black. Replaces original part # 2417423 and 2417427.
Note: Will only fit on 22" radiators.
MB2337 1962-68..... 254.99 ea

B & E-Body

1970-73 V-8 Fan Shroud— Radiator fan shroud for 1970-73 B & E-Body V-8 models. This injection molded urethane shroud will replace your damaged original on 318, 340, 383 and 440 models. Will only fit on 22" radiators. Replaces original part # 2998328.
MD2225 1970-73..... 164.99 ea



Universal Fan Shrouds

Each shroud will fit small block and big block radiators. Mounting hardware is included for installation. Simply remove your original fan shroud and replace it with this shroud. Available in chrome or EDP black finishes.

3" Wide 20" Diameter Shrouds
T9453 chrome..... 19.99 ea
T9451 EDP black..... 39.99 ea

5-1/2" Wide 20" Diameter Shrouds
T9454 chrome..... 39.99 ea

MD2224

1962-74 Fan Shroud Brackets

1962-68 B-Body

Replacement mounting hardware set for 1962-68 B-Body models with 22" radiators and steel fan shroud. This set mounts the fan shroud to the radiator, includes (4) powder coated formed steel brackets, (4) correct 1/4-20 cage nuts for the radiator side brackets and (8) 1/4-20 x 1/2" hex head bolts.
MB2338 1962-65..... 54.99 set
MB2339 1966-68..... 54.99 set

1969-74 B & E-Body

This set attaches the fan shroud to the radiator, includes (2) powder coated formed steel brackets, (4) correct 1/4-20 cage nuts for the radiator side brackets and (8) 1/4-20 x 1/2" hex head bolts.
Note: For 22" radiator only.
MD2224 1969-73 B-Body. 69.99 set
MD2224 1970-74 E-Body. 69.99 set

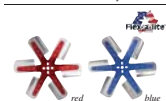

Flex-A-Lite Series 1300 Flex Fan

Stainless steel blades flex at higher RPMs which reduces drag, pumps extra horsepower and improves fuel economy. For high-performance and heavy-duty applications. Flex-A-Lite fan spacers are sold separately.

Note: Not for use with fan clutch.
Custom Red
FL1307 17"..... 59.99 ea
FL1308 18-3/8"..... 64.99 ea
FL1309 19-1/2"..... 64.99 ea

Traditional Blue
FL1317 17"..... 54.99 ea
FL1318 18-3/8"..... 54.99 ea
FL1319 19-1/2"..... 59.99 ea



Derale Rigid Race Fans

Derale high performance replacement fans feature durable construction with excellent balance and are rated for up to 8,000 RPM. Manufactured with a universal heavy duty steel hub with a 5/8" pilot hole. Available with riveted steel or aluminum blades.

Note: Not for use with fan clutch.
Steel Blade Standard Rotation
17317 17"..... 34.99 ea
17318 18"..... 34.99 ea
17319 19"..... 34.99 ea
17320 20"..... 34.99 ea

Aluminum Blade Standard Rotation
A5600101 15"..... 44.99 ea
A5600102 17"..... 44.99 ea
A5600103 18"..... 44.99 ea

Steel Blade Reverse Rotation
A5600104 17"..... 34.99 ea
A5600105 18"..... 34.99 ea
A5600106 19"..... 34.99 ea
A5600107 20"..... 34.99 ea

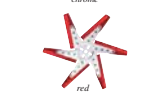

Derale Aluminum Fan Blades

These stainless steel fan blades are rated up to 7000 rpm and feature chrome plated hubs. They feature a narrow blade design for good airflow in tight space applications. Embossed center hubs and four rivet blade attachment provide increased strength. Derale fan spacer and billet aluminum nose cone are sold separately.

17" Diameter
9217 chrome..... 49.99 ea
9417 red..... 44.99 ea
9517 blue..... 44.99 ea

18" Diameter
9218 chrome..... 49.99 ea
9418 red..... 44.99 ea
9518 blue..... 44.99 ea



Flex-A-Lite OEM Style Fans

Replacement original-style fan blades for most Mopar applications. Manufactured by Flex-A-Lite for performance and reliability, these OEM style fan blades are perfect for use with a fan clutch. 8 bolt holes for mounting onto water pumps, fan clutches, or Flex-A-Lite spacers.

FL5715 15"..... 41.99 ea
FL5717 17"..... 41.99 ea
FL5718 18"..... 44.99 ea
FL5719 19"..... 44.99 ea



"Ice Box" Cooling Fan Control

Available as a single fan control or dual fan 2-speed fan control unit. The sensor is simply tightened under an intake or water pump bolt. It can then be adjusted to your exact preference for on and off temperature. It is equipped with an A/C Request system to turn the cooling fan on whenever the A/C Compressor engages (this feature does not have to be used). The dual fan control can operate two fans at different temperatures or a single two speed fan at different temperatures. Features exclusive lug sensor that mounts under almost any engine belt. Each unit has a fully adjustable operating range of 140-230 degrees.

*Note: *With Walker 2-speed fans.*
TF900633 single control 124.99 ea
TF900634 dual control..... 139.99 ea
TF900635 dual control..... 139.99 ea



1962-79 Cooling Fan Shutdown

This cooling fan shutdown kit shuts down your electric cooling fan above 50-60 MPH to improve engine cooling by preventing the electric fan from fighting airflow through the radiator at highway speeds. In vehicle testing, a ten degree drop in engine temperatures while operating above 60 MPH was seen. The unit is adjustable and may be overridden by using the supplied dash mounted toggle switch. This kit is designed to be used with the supplied signal generator which must be installed into the speedometer cable.
TF900627 1962-79..... 189.99 ea

Electric Cooling Fans



Flex-a-Lite Universal Electric Fans

This fan can either be used as a primary cooling fan or an auxiliary fan to the stock belt-driven fan by mounting it in the front of the radiator. Available in 12", 14", 15" and 16" diameter. Required wiring and hardware is included when applicable.

Push Style - Mounts in Front of Radiator	
FL114 14-3/4" x 14" x 3-1/4"	109.99 ea
16" Single Fan	
FL116 16-1/2" x 16" x 3-1/4"	119.99 ea
Pull Style - Mounts Behind Radiator	
12" Dual Fans	
FL210 15-1/2" x 26-1/4" x 2-5/8"	399.99 ea
15" Single Fan	
FL030 18" x 16" x 4-1/4"	249.99 ea

Flex-a-Lite S-Blade Electric Fans

These quiet but powerful fans feature sweep style blades for maximum air flow, mount to the radiator core and can be used to push or pull air through the radiator. The high torque motor makes these fans strong enough to replace your belt-driven fan and fan clutch, freeing up horsepower and torque.



FL392 12-5/8" x 11-3/4" x 2-5/8"	99.99 ea
FL394 14-1/2" x 13-7/8" x 3-3/4"	104.99 ea
FL396 16-5/8" x 15-3/4" x 4"	129.99 ea

Flex-a-lite Black Magic S-Blade

This universal fit Flex-a-lite electric fan features an extremely quiet yet efficient computer-engineered blades that flow 3,000 CFM of air, offering you consistent cooling regardless of engine RPM. Ring-type fans like this one provide better blade support and impact resistance. Fits vehicles with 16" or wider radiator cores and requires a mounting surface of 18" x 16" x 4-1/4". Includes universal mounting brackets.



FL160 16" fan 3,000 CFM	304.99 ea
-------------------------	-----------

Flex-a-Lite Cyclone Electric Fan

Flex-a-Lite Cyclone electric fan mounts to the core and can be used to push or pull air through the radiator.

The higher torque (17 amp) motor and maximum flow sweep-style blades produce 2,500 CFM of air flow, making these fans strong enough to replace your engine-driven fan clutch to free up horsepower and torque.

FL398 16" fan 2,500 CFM	144.99 ea
-------------------------	-----------



15" Fan w/Thermostat

Universal-fit fan with an adjustable 180°-240°F thermostat. Features a heavy-duty motor and 15" diameter high-angle blades. Flows 2,800 CFM of air, cooling vehicles with 250+ HP (w/o AC) and 220+ HP (w/AC). Overall 18" x 16-1/8" x 4" Amp draw - 14 amps.

67017 15" fan 2,800 CFM	164.99 ea
-------------------------	-----------



High Performance Fans

These high performance electric fans are available in 10" 12" 14" and 16" sizes and are reversible allowing use as a pusher or puller fan. Reinforced glass filled polypropylene blade and plastic housing for minimal weight. Nylon tie mounting kit included. Nominal fan size is based upon approximate overall assembly diameter.

3000 RPM 7 Amp	
67010 10" x 2-1/2"	1000 CFM..... 46.99 ea
67012 12" x 2-1/2"	1200 CFM..... 54.99 ea
2500 RPM 8 Amp	
67014 14" x 4"	1650 CFM..... 64.99 ea
2000 RPM 9 Amp	
67016 16" x 4"	2100 CFM..... 65.99 ea



High Performance Fans

Its quiet, reversible S-blade design allows use as a puller or a pusher fan. Manufactured from glass filled nylon. Includes (4) 90° mounting feet, mating locking pigtail and rubber spacer. Recommended wire harness, temperature switch and adjustable thermostat sold separately.



High Performance Fans

Low Profile	
12" Fan - 130 Watt	
MF123 1,155 CFM, 2.48" deep	114.99 ea
14" Fan - 160 Watt	
MF146 1,555 CFM, 2.87" deep	119.99 ea
16" fan - 160 Watt	
MF166 1,810 CFM, 2.87" deep	144.99 ea

High Output Performance Fans

Low Profile	
12" Fans - 225 Watt	
MF122 1,565 CFM, 3.19" deep	134.99 ea
14" Fans - 225 Watt	
MF142 2,135 CFM, 3.19" deep	139.99 ea
16" Fans - 225 Watt	
MF163 2,170 CFM, 3.19" deep	149.99 ea

Standard Profile

13" Fans - 160 Watt	
MF136 1,550 CFM, 3.82" deep	91.99 ea
16" Fans - 160 Watt	
MF107 1,950 CFM, 3.87" deep	95.99 ea
16" Fans - 225 Watt	
MF162 2,200 CFM, 4.35" deep	101.99 ea

Fan Temperature Sending Unit

The temperature sending unit screws into the side of the cylinder head or on the intake manifold to operate the Champion or Challenger Series fans.

MF108 185° for carbureted engines	21.99 ea
MF109 195° for fuel injected engines	21.99 ea



Painless F5 Fan Controller

This fan control system uses pulse width modulation to control electric fan speed from 50% up to 100%.

A three position toggle switch lets you choose between normal operation, 100% fan speed, or turn the fan(s) off. An override runs the fans at 100% if AC is kicked on. Includes a solid-state controller rated for engine bay use, 3/8" NPT threaded temperature sensor, large gauge fan wires and labeled vehicle integration wire harness, mounting hardware, and 70 Amp fuse and connectors.

30140 single 35A fan controller	269.99 set
30141 dual 70A fan controller	269.99 set

Fan-Thom Electric Fan Relay

This relay protects your fans from voltage and amperage spikes, and keeping the fan from feeding back through the system. Sets that include a threaded thermostat screw into the engine block or manifold for a professional installation. Thermostat thread size: 3/8"-18NPT fitting.

Note: No further discounts apply.

Electric Fan Relay Sets	
Without Thermostat	
30101	39.99 set
With Thermostat	
30102 195° on/185° off	84.99 set
30106 185° on/175° off	85.99 set

Weatherproof Relays	
30130	65.99 ea
30128 w/195° on/185° off thermostat	114.99 ea
30129 w/185° on/175° off thermostat	109.99 ea

Replacement Thermostats	
30110 195° on/185° off	47.99 ea
30111 185° on/175° off	47.99 ea

Adjustable Electric Fan Thermostat Set

This set allows a wide range temperature adjustments for your electric fan. The complete set includes the thermostat with bracket, a 30 amp relay, a 30 amp circuit breaker for overall protection wiring, terminals and mounting hardware. Temp range

-32 deg to 248 deg F	30104
----------------------	-------

Note: Temperature refers to the temp of the capillary tube, not the coolant temp. No further discounts apply.

30104 complete set	114.99 set
30112 without relay	81.99 set

Dual Fan - Dual Activation Fan Relay Set

Need cooling fan relays to operate off of a thermostatic switch and when your AC is on? This dual activation cooling fan relay kit by what you need. Each kit includes: (3) 40 Amp relays, (1) fuse holder w/ 70 amp fuse, pre-terminated wire harness, thermostatic switch (thread size: 3/8"-18NPT), 1/2" NPT to 3/8" NPT adapter, mounting hardware, insulated terminals, and detailed instructions.

30116 on at 195° off at 185° F	148.99 set
30117 on at 185° off at 175° F	139.99 set
30118 on at 205° off at 190° F	129.99 set

Cooling Fan Components



Electric Fan Wire Harness

This set is designed to allow a wide range of temperature adjustments for Champion or Challenger Series electric fans. Includes a heavy gauge wire harness, relay, weatherproof fuse, electrical connectors and adjustable temperature switch.

MF100 w/adj. temperature switch..... 61.99 set



Adjustable Fan Temperature Switch

The adjustable temperature switch allows a wide range of temperature on/off settings for the Champion or Challenger Series electric fan.

MF110 21.99 set



Adjustable Fan Temperature Sensor

Set your electric fan to turn on at whatever temperature you choose with this adjustable temperature sensor. Sensor adjusts from 180°-240° and can help prevent overheating in performance vehicles when driving at low speeds or when idling for long periods.

346932 180°-240°..... 42.99 ea



Flex-A-Lite Fan Spacers

Correct replacement mechanical fan spacers for use on various applications. Available in silver.

FL14544 1/2" spacer..... 15.99 ea
FL14548 1" spacer..... 15.99 ea
FL14556 2" spacer..... 19.99 ea



Cooling System Zinc Anode

Used in heavy duty and marine applications to protect the cooling system and its many components from damage due to electrolysis or coolant additive breakdown. Today's cars and trucks have many aluminum parts and parts made with aluminum alloy. Aluminum parts tend to disintegrate from electrolysis in the cooling system. Adding this sacrificial zinc anode will protect your cooling system from galvanic action as it "eats" the zinc rather than of your cooling system. Designed for installation in the radiator as a replacement for the drain petcock in radiators that are equipped with a 1/4" NPT hole or any 1/4" NPT hole that is available in the cooling system.

FL32060 19.99 ea



Electric Fan Wire Harness

This set is designed to allow a wide range of temperature adjustments for Champion or Challenger Series electric fans. Includes a heavy gauge wire harness, relay, weatherproof fuse, electrical connectors and 185° or 195° temperature sending unit.

For Carbureted Vehicles
MF102 w/185° temp. sender 61.99 set
For Fuel Injected Vehicles
MF103 w/195° temp. sender 61.99 set

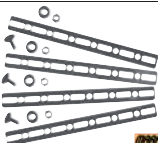

Universal Fan Bracket Strip Set

This bracket set is used to mount your Champion or Challenger Series fan. Install the fan's 90° mounting feet (included with fan) to these four 7.25" long strips for solid support. Mounting hardware is included.

MF104 19.99 set



Champion Series Fan Rubber Spacers

Rubber spacers for use with Champion Series electric fans to allow proper spacing from the radiator.

MF112 4.99 set



Billet Aluminum Fan Brackets

Use this premium billet aluminum bracket set to mount your 14" or 16" Champion or Challenger Series fan. The set features four adjustable side angle brackets that attach to the side flange of the radiator. Mounting hardware is included.

MF105 45.99 set



Engine Coolant Plumbing Kit Components

Build your own custom silicon radiator hose system or add onto the basic set (Z71051) with these components! Coolant tubes are available in aluminumized steel and stainless. Mandrel bends tubes feature beaded ends for a positive seal with the available high quality reinforced black silicone hoses. Hoses and tubes are available in 1-1/4" to 1-3/4" diameters.

Note: w/8" step-up/down connector.

Aluminumized Steel Coolant Tubes

Z71000 1-1/4" x 4' x 6" 90° bend..... 24.99 ea
Z71001 1-1/2" x 4' x 6" 90° bend..... 24.99 ea
Z71002 1-3/4" x 4' x 6" 90° bend..... 24.99 ea
Z71003 1-1/2" x 4' x 6" 75° bend..... 24.99 ea
Z71004 1-1/2" x 4' x 6" 75° bend..... 29.99 ea
Z71005 1-3/4" x 4' x 6" 75° bend..... 29.99 ea
Z71006 1-1/4" x 4' x 6" 45° bend..... 24.99 ea
Z71007 1-1/2" x 4' x 6" 45° bend..... 24.99 ea
Z71008 1-3/4" x 4' x 6" 45° bend..... 24.99 ea

Stainless Steel Coolant Tubes

Z71060 1-1/2" x 4' x 4" 90° bend..... 34.99 ea
Z71061 1-3/4" x 4' x 4" 90° bend..... 44.99 ea
Z71063 1-3/4" x 4' x 4" 75° bend..... 44.99 ea
Z71064 1-1/2" x 4' x 4" 45° bend..... 34.99 ea
Z71065 1-3/4" x 4' x 4" 45° bend..... 44.99 ea
Z71066 1-1/2" x 3" straight tube..... 24.99 ea
Z71067 1-3/4" x 3" straight tube..... 29.99 ea

Reinforced Black Silicone Hoses

Z71031 1-1/4" x 5' x 5" 90° bend..... 24.99 ea
Z71032 1-1/2" x 5' x 5" 90° bend..... 24.99 ea
Z71033 1-3/4" x 5' x 5" 90° bend..... 29.99 ea
Z71028 1-1/4" x 4' x 4" 45° bend..... 19.99 ea
Z71029 1-1/2" x 4' x 4" 45° bend..... 24.99 ea
Z71030 1-3/4" x 4' x 4" 45° bend..... 29.99 ea
Z71025 1-1/4" x 6' straight hose..... 14.99 ea
Z71026 1-1/2" x 6' straight hose..... 14.99 ea
Z71027 1-3/4" x 6' straight hose..... 14.99 ea
Z71035 1-1/4" to 1-1/2" 24.99 ea
Z71036 1-1/2" to 1-3/4" 24.99 ea

Silicone Engine Coolant Plumbing Set **New!**

Get the durability of silicone coolant hoses for your custom engine install with these basic universal sets. Each set contains a 90°, a 45° angled, and a straight 1-1/2" reinforced black silicone hose along with a 1-1/2" 45° mandrel bent and one straight aluminumized steel tube each featuring beaded ends for a positive seal.

Z71051 1-1/2" 79.99 set



Cooling System Components



HF1318

Flexible Universal-Fit Radiator Hoses

If you're doing an engine swap in your classic Mopar, these flexible radiator hoses, available in a variety of sizes, may be just what you need to complete the cooling system. Each hose is designed to conform to a variety of bends and curves without kinking or collapsing.

HF1107 1-1/4" x 7-3/8"	5.99 ea
HF1111 1-1/4" x 11"	9.99 ea
HF1119 1-1/4" x 19-9/16" x 1-1/2"	9.99 ea
HF1123 1-1/4" x 23"	13.99 ea
HF1208 1-1/2" x 7-9/16"	5.99 ea
HF1211 1-1/2" x 10-11/16"	9.99 ea
HF1212 1-1/2" x 12-3/16"	9.99 ea
HF1317 1-1/2" x 16-5/16" x 1-3/4"	9.99 ea
HF1217 1-1/2" x 17-1/16"	9.99 ea
HF1318 1-1/2" x 19-1/2" x 1-3/4"	13.99 ea
HF1220 1-1/2" x 19-13/16"	13.99 ea
HF12205 1-1/2" x 20-1/2"	9.99 ea
HF1222 1-1/2" x 22"	14.99 ea
HF12228 1-1/2" x 22-7/8" 90° end	10.99 ea
HF1223 1-1/2" x 23" x 1-3/4"	9.99 ea
HF1225 1-1/2" x 25"	13.99 ea
HF1214 1-1/2" x 30"	9.99 ea
HF1316 1-3/4" x 16-5/16"	13.99 ea
HF1319 1-3/4" x 18-13/16"	13.99 ea
HF1323 1-3/4" x 23-1/2"	9.99 ea



MD2218

1966-74 Hose Clamp Sets

Hose clamp sets for all 1966-74 small block, big block and Hemijet models. This set features correct spring clamps and each set includes four radiator clamps and four heater hose clamps.

MD2221 1966-69	small block	11.99 set
MD2222 1970	small block	14.99 set
MD2223 1971-74	small block	14.99 set
MD2218 1966-69	Hemijet/Big block	9.99 set
MD2219 1970	Hemijet/Big block	11.99 set
MD2220 1971-74	Hemijet/Big block	12.99 set



Universal Coolant Filter

Prevent dangerous clogs in your cooling system with this in-line heater hose filter. Features a heavy duty solid brass construction.

RF002 universal heater hose filter 39.99 set



K1231

Radiator Hose Reducer Bushings

These rubber hose reducers are designed for custom applications to allow the use of a larger ID radiator hose with smaller inlets and outlets on radiators, water pumps and thermostat housings. Simply insert them into the hose before installation.

K1231 2" ID to 1-3/4" ID	8.99 ea
K1232 1-3/4" ID to 1-5/8" ID	11.99 ea
K1233 1-3/4" ID to 1-1/2" ID	8.99 ea



1962-76 Chrome Water Neck

Aftermarket chrome water neck/thermostat housing for 1962-76 models with small block or big block engine. Each water neck comes complete with gasket and bolts.

T4987 1962-76	small block/big block	17.99 ea
---------------	-----------------------	----------



High Flow Thermostat

Features a "balanced sleeve" design that equals pressure exerted on it by a high-flow water pump. In combination with high-flow water pump, decreases coolant temperatures up to 25°.

MD16405 160°	24.99 ea
MD16406 180°	24.99 ea

New!



VP2006

Cool-View Glass Thermostat Assembly

This new style 2" thermostat assembly allows you to see your coolant without ever removing the radiator cap. Made from billet aluminum and the same specialized heavy borosilicate glass used in steam boiler systems. It is designed to accept thermostats and restrictor plates. Fits 1951-78 Mopar V8 engines, and all flathead straight 4, 6, & 8 cylinder engines 1924 and newer. Made in USA.

Important: Index pointer and gradient scale are only included in sets with thermostat. Do not use on 1960 and older engines equipped with a bypass water outlet and thermostat. Will not fit slant 6 or small block V8 engines 1979 or newer.

Note: No further discounts apply.
Bolts and water neck not included.

VP2004 w/o thermostat	109.99 ea
VP2005 w/180° thermostat	139.99 ea
VP2006 w/195° thermostat	139.99 ea

New!



1960-77 High Performance Thermostat

These high performance thermostats are designed to resist variations in coolant pressure, opening and closing only at the correct temperatures, regardless of engine RPM. Thermostats are made from brass and copper with a high grade steel frame for years of worry free operation.

43661 1960-74 160° thermostat	15.99 ea
43671 1960-74 180° thermostat	15.99 ea
43631 1975-77 160° thermostat	15.99 ea
43641 1975-77 180° thermostat	15.99 ea

Thermostat Housing Bolts



Premium quality thermostat bolts for high performance applications. Properly engage manifold threads and resist loosening. Available in your choice of black oxide finish chrome moly or rust-proof stainless steel with handy 12-point or standard hex heads. Washers included. Each set includes 3 bolts:

(2) 1" bolts and (1) 2" bolt.	
AR13742 black oxide hex head	6.99 set
AR13741 black oxide 12-point	6.99 set
AR43742 stainless hex head	7.99 set
AR43741 stainless 12-point	6.99 set



Heater Hose Fittings

Made in USA

These fittings are for use with heater hoses or bypass hose attachments. Available in steel and stainless steel.

Steel	
Heater Fitting	
KO1148 5/8" x 1-3/4", 3/4" x 2-7/8"	19.99 pr
KO150 5/8" x 1-3/4", 3/4" x 1-3/4"	19.99 pr
Bypass Fitting	
KO151 3/4" x 1-3/4"	19.99 pr

Stainless Steel	
For 5/8" ID Hose	
PF1007 (1) 1-3/4" & (1) 2-7/8" long	29.99 pr
PF1006 (2) 1-3/4" long	25.99 pr
For 5/8" ID Hose with 1/2" Pipe Plugs	
PF1025 5/8" OD x 1-3/4" & 2-7/8" long	43.99 set
For 5/8" & 3/4" ID Hose	
PF1008 (1) ea 1-3/4" long	25.99 pr
PF1009 (1) 1-3/4" & (1) 2-7/8" long	29.99 pr
For 5/8" & 3/4" ID Hose with 1/2" Pipe Plugs	
PF1026 5/8" & 3/4" OD x 1-3/4" long	39.99 set
PF1027 5/8" & 3/4" OD x 2-7/8" long	42.99 set



Coolant System Protector

Impurities in well water can cause rust and corrosion inside the radiator, water pump, and cylinder heads. Over time, this can lead to a loss of cooling efficiency. Joe Gibbs Driven Coolant System Protector stops the adverse effect of hard water to help prevent cooling system damage.

JG1330 12 oz bottle	9.99 ea
JG1331 case of 12 - 12 oz bottles	119.99 ea



Purple Ice Super Coolant

Purple Ice is a high performance, synthetic, radiator coolant additive. It reduces engine heat, fosters optimum coolant flow and lubricates the water pump seals. Purple Ice should always be used in conjunction with antifreeze in regions where freezing temperatures occur. Purple Ice is recommended for any water / glycol pressurized cooling system, including those using the traditional green silicate based glycols or the newer OAT or HOAT based glycols.

RF01600 16 oz. bottle	9.99 ea
RP12600 case of 12 - 16 oz. bottles	183.99 ea

Water Pumps & Parts



Aluminum Water Pump Housing

Reproduction aluminum water pump housing for models with big block or Hemi engines. Fits all B/RB engines and weighs only 6.5 pounds. Replaces OE part# P4286900.

MD2587 179.99 ea



BB Aluminum Water Pump

Reproduction aluminum water pump for models with big block and Hemi engines. Fits all B/RB engines and weighs only 4 pounds. Features large heavy duty bearings and flows 39.6 GPM at 4,000 RPM. Replaces OE part# P4529102 and P5007643AC.

MD2588 94.99 ea



MD1620

1960-76 Milodon Water Pumps

Engineered for increased performance and reliability in all applications. The High Volume performance aluminum and steel water pump models increase the pressure within the block to help prevent hot spots and steam pockets and improve coolant flow through the radiator.

Steel

1960-69 Small Block

MD16251 318-360..... 89.99 ea

Aluminum

1970-76 Small Block

MD16250 318-360..... 89.99 ea

1960-76 Big Block

MD16260 383, 400..... 99.99 ea

1970-74 Water Pump Bolt Set

Water pump mounting bolt set for 1970-74 Mopar models with 318, 340, and 360 engines. Made from steel and coated in black phosphate.

MM8276 1970-74..... 29.99 set



MD2303

1969-76 8B Water Pumps

Direct replacement for stock water pump, will accept all factory pulleys and accessories. Special cast-iron impeller and tight clearances provide increased coolant flow, block pressure and balanced delivery. Features heavy-duty ball/roller bearing and seal, available in as-cast finish or polished. Will fit 318-360 Chrysler engines. Dimension from block surface to hub: 5.5". Inlet diameter: 1.75".

Note: No further discounts apply.
MD2303 as-cast finish..... 239.99 ea
MD2304 polished..... 331.99 ea



1969-76 8B Water Pumps

Engineered to directly replace the stock pump in the factory cast-iron housing. Will fit any 361-440 Chrysler engine, including 426 Hemi with a 5/8" pilot shaft. Dimension from block surface to hub: 3.07".

Note: No further discounts apply.
MD2305 as-cast finish..... 174.99 ea



MD2379

Water Pump Pulleys

Reproduction water pump pulleys for models with small block, big block or Hemi engines and without AC. Features either a black finish or chrome finish and fits and function as original.

Single-Groove

SB w/o AC

MD2377 black..... 64.99 ea

BB/Hemi w/o AC

MD2375 black..... 64.99 ea

SB w/o AC

MD2378 chrome..... 74.99 ea

BB/Hemi w/o AC

MD2376 chrome..... 74.99 ea

Double-Groove

B/RB/Hemi w/AC & PS

MD2379 black..... 69.99 ea

B/RB/Hemi w/AC & PS

MD2380 chrome..... 79.99 ea

1968-72 Water Pump Belts



Reproduction water pump belts for 1969-72 models. Officially licensed by Mopar, they feature indented imprinting of the correct Mopar part numbers, manufacturer's code, approximate date code.

Chrysler Pentastar logo and they are cloth wrapped. These authentic looking reproductions are the finishing touch to any serious restoration and a great way to gain points over your car show competitors. You don't want something as simple as a worn or incorrect belt to keep you from winning your next trophy, and you certainly don't want to be left stranded on the way to your next show. Officially licensed by Mopar!

B4720	1970	Barracuda, 318, 340, 360 w/AC (37").....	36.99 ea
B4721	1970	Barracuda, 318, w/AC (37-1/2").....	36.99 ea
B4720E	1971	Barracuda, 318, 340, 360 w/AC (37").....	36.99 ea
B4721E	1971	Barracuda, 318, w/AC (37-1/2").....	36.99 ea
B4723E	1971	Barracuda, 383, 440 w/AC.....	36.99 ea
B4760	1972	Barracuda, 318, 340, w/o PS w/AC (37").....	36.99 ea
B4760	1972	Barracuda, 318, 340, w/o PS w/AC (37-1/2").....	36.99 ea
B4608	1969	Belv. Chrg. Cmt. Rd Rr 383, 440.....	36.99 ea
B4720	1970	Belv. Chrg. Cmt. Rd Rr 318, 340, 360 w/AC (37").....	36.99 ea
B4720	1970	Cmt. Rd Rr 318, 340, 360 w/AC (37").....	36.99 ea
B4721	1970	Belv. Chrg. Cmt. Rd Rr 318 w/AC (37-1/2").....	36.99 ea
B4722	1970	Belv. Chrg. Cmt. Rd Rr 383, 440 w/AC.....	36.99 ea
B4720E	1971	Belv. Chrg. Cmt. Rd Rr 318, 340, 360 w/AC (37").....	36.99 ea
B4720E	1971	Cmt. Rd Rr 318, 340, 360 w/AC (37-1/2").....	36.99 ea
B4721E	1971	Belv. Chrg. Cmt. Rd Rr 318, w/AC (37-1/2").....	36.99 ea
B4723E	1971	Belv. Chrg. Cmt. Rd Rr, 383, 440 w/AC.....	36.99 ea
B4760	1972	Belv. Chrg. Cmt. Rd Rr 318, 340 w/o PS w/AC (37").....	36.99 ea
B4760	1972	Cmt. Rd Rr 318, 340, w/o PS w/AC (37").....	36.99 ea
B4761	1972	Belv. Chrg. Cmt. Rd Rr 318, 340 w/o PS w/AC (37-1/2").....	36.99 ea
B4762	1972	Cmt. Rd Rr 318, 340, w/o PS w/AC (37-1/2").....	36.99 ea
B4762	1972	Belv. Chrg. Cmt. Rd Rr 400, 440 w/AC.....	36.99 ea
B4720	1970	Challenger, 318, 340 w/o AC (37").....	36.99 ea
B4721	1970	Challenger, 318, w/AC (37-1/2").....	36.99 ea
B4720E	1971	Challenger, 318, 340 w/o AC (37").....	36.99 ea
B4721E	1971	Challenger, 318 w/AC (37-1/2").....	36.99 ea
B4723E	1971	Challenger, 383, 440 w/AC.....	36.99 ea
B4760	1972	Challenger, 318, 340 w/o PS w/AC (37").....	36.99 ea
B4761	1972	Challenger, 318, 340, w/o PS w/AC (37-1/2").....	36.99 ea
B4720	1970	Chrysler Pass. Car, 318, 340, 360 w/AC (37").....	36.99 ea
B4720E	1971	Chrysler Pass. Car, 383, 440 w/AC.....	36.99 ea
B4720E	1971	Chrysler Pass. Car, 318, 340, 360 w/AC (37").....	36.99 ea
B4723E	1971	Chrysler Pass. Car, 383, 440 w/AC.....	36.99 ea
B4762	1972	Chrysler Pass. Car, 400, 440 w/AC.....	36.99 ea
B4720	1970	Dart, 318, 340, 360 w/AC (37").....	36.99 ea
B4722	1970	Dart, 383, 440 w/AC.....	36.99 ea
B4720E	1971	Dart, 318, 340, 360 w/AC (37").....	36.99 ea
B4760	1972	Dart, 318, 340 w/o PS w/AC (37").....	36.99 ea
B4608	1969	Dodge/Ply, 383, 440 w/AC.....	36.99 ea
B4720	1970	Dodge/Ply, 318, 340, 360 w/AC (37").....	36.99 ea
B4721	1970	Dodge/Ply, 318 w/AC (37-1/2").....	36.99 ea
B4722	1970	Dodge/Ply, 383, 440 w/AC.....	36.99 ea
B4720E	1971	Dodge/Ply, 318, 340, 360 w/AC (37").....	36.99 ea
B4721E	1971	Dodge/Ply, 318, w/AC (37-1/2").....	36.99 ea
B4723E	1971	Dodge/Ply, 383, 440.....	36.99 ea
B4720	1970	Valiant, 318, 340, 360 w/AC.....	36.99 ea
B4720E	1971	Valiant, 318, 340, 360 w/AC.....	36.99 ea
B4760	1972	Valiant, 318, 340, 360 w/o PS w/AC.....	36.99 ea



B4720

Water Pump Pulley Warning!

Stock replacement after-market stamped steel or cast iron pulleys are not designed to exceed 400 horsepower or 6000 RPM. Using reproduction pulleys on engines in excess of these limits may result in catastrophic disintegration of the pulley causing severe damage to the engine, cooling system and body parts. Classic Industries® assumes no liability for damages caused by improper usage of pulleys.



30132

Electric Water Pump Relay

These water pump relays provide full battery voltage to maximize cooling efficiency and to protect the electrical system from damaging amperage overloads.

Note: No further discounts apply.
50106 44.99 ea
30132 weatherproof..... 65.99 ea

Air Conditioning Systems

Gen-IV SureFit System Features:

- Electronic Servo Motor Controls
- Dehumidified Defrost with Dash/Floor Blend
- No Cables or Capillary Tube To Route
- Analog Blower Speed Adjustment
- Separate High Capacity Heat & Cooling Coils
- Includes New In-Dash Control Panel
- AC Exits Through Original AC Dash Vents
- Mounts Behind Dash

New!



974074



1966-74 Vintage Air Gen-IV SureFit R134a Systems

This complete air conditioning retrofit system features air conditioning, heating and defrost functions and is designed specifically to mount in your vehicle using existing holes in your dash and firewall without drilling or fabrication. The exclusive cable replacement modules connect to your original AC control assembly to operate the system as if it were installed by the factory. The system comes with the compressor, evaporator, condenser and mounting brackets for each, as well as a standard drier, all louvers, ducts, hoses, wiring, and pre-formed aluminum lines, and complete installation instructions.

Important: Some installations may require additional engine pulleys not included with these systems. V-belts and refrigerant not included.

Note: Special shipping charges apply. Special order, must be pre-paid.

Shipped overseas. No further discounts apply.



1966-68 B-Body

Coronet/Charger			
971067	1966-67	w/factory AC	1324.99 set
971066	1966-67	w/o factory AC	1324.99 set
Belvedere/Satellite/GTX			
971061	1966-67	w/factory AC	1324.99 set
971060	1966-67	w/o factory AC	1324.99 set
Coronet/Super Bee/Charger			
971063	1968	w/factory AC	1324.99 set
971062	1968	w/o factory AC	1324.99 set
Road Runner/Satellite/GTX			
971063	1968	w/factory AC	1324.99 set
971062	1968	w/o factory AC	1324.99 set

1969-70 B-Body

Coronet/Super Bee/Charger			
976971	1969-70	w/factory AC	1324.99 set
976970	1969-70	w/o factory AC	1324.99 set
Road Runner/Satellite/GTX			
976971	1969-70	w/factory AC	1324.99 set
976970	1969-70	w/o factory AC	1324.99 set

1970-74 E-Body

Challenger/Cuda			
974074	1970-74	factory AC standard gauges	1349.99 set
974073	1970-74	factory AC Rallye gauges	1349.99 set
971074	1970-74	w/o factory AC	1349.99 set

"Perfect Fit" System Features:

- All interior components
- Evaporator assembly
- Condenser kit
- Pre-cripped refrigeration hoses
- Sanden-style compressor
- Hi-Low refrigerant pressure switch
- Aluminum hookup tubes
- Compressor mounting hardware
- Installation instructions & templates



ME175925

1966-74 "Perfect Fit" Air Conditioning Kits

These "Perfect Fit" air conditioning retrofit systems upgrade your standard, non-AC 1966-74 Mopar with full air-conditioning. Using the original heater controls and dash louvers, these systems provide powerful air conditioning, under-dash heating, and dehumidified window defrosting. Each "Perfect Fit" AC system is designed specifically for each application with minimal modifications. These AC sets include all interior components as well as an evaporator, condenser, Sanden-style compressor and all mounting and hose routing hardware necessary. Instructions and templates also included.

Important: * With 318 Poly engine.

Note: Shipped double oversize. No further discounts apply.



1967-72 A-Body

Small Block			
MAR20151	with iron WP & PS	1399.99 kit	
MAR20152	with alum WP	1399.99 kit	
Big Block			
MAR20153	with WP casting #2780987	1399.99 kit	

1966-67 Dodge B-Body

Small Block			
MB184535	with iron WP & PS	1399.99 kit	
MB184536	with alum WP	1399.99 kit	
MB184537*	with PS	1399.99 kit	
Big Block			
MB184538	with WP casting #2780987	1399.99 kit	

1966-67 Plymouth B-Body

Small Block			
MB184539	with iron WP & PS	1399.99 kit	
MB184540	with alum WP	1399.99 kit	
MB184541*	with PS	1399.99 kit	
Big Block			
MB184542	with WP casting #2780987	1399.99 kit	

1968-70 B-Body

Small Block			
MB184543	with iron WP and PS	1524.99 kit	
MB184544	with alum WP	1524.99 kit	
Big Block			
MB184545	with WP casting #2780987	1524.99 kit	

1970-74 E-Body

Small Block			
ME175925	with alum WP	1399.99 set	
Big Block			
ME175926	with WP casting #2780987	1399.99 set	

AC Upgrade Kits



MB184524

- KITS INCLUDE:**
- Sanden-Style Compressor
 - Mounting Brackets
 - Idler Pulleys
 - Compressor Hoses
 - Thermostat
 - Expansion Valve
 - All Mounting Hardware

1965-75 B-Body AC Compressor Upgrade Kits

Replace your power-robbing RV2 compressor with a Sanden-style compressor upgrade that requires less power to operate, runs smoother, and weighs half as much as the original units. These upgrade kits are rated for continuous duty at 6,000 RPM and work great on high-horsepower applications! Includes compressor, mounting brackets, idler pulleys, compressor hoses, thermostat, expansion valve, o-rings, hardware, refrigerant tape, and filter-drier. Compatible with R134a.

Important: For factory AC applications w/original pulleys. Not for 6-Pack or Shaker engines.

Note: Special order; must be pre-paid.

MB184509 1965-69 small block w/PS	531.99 set
MB184523 1965-67 big block	531.99 set
MB184524 1968-70 big block	531.99 set
MB184525 1970-75 small block	531.99 set
MB184525 1970-75 big block	531.99 set



MD646755

KITS INCLUDE:

- Sanden-Style Compressor
- Condenser
- Idler Pulleys
- Compressor Hoses
- Thermostat
- Expansion Valve
- All Mounting Hardware

1968-74 B & F-Body Engine Compartment AC Upgrade Kits

This kit has everything you need to upgrade to modern R134a — just add refrigerant! This system works with stock evaporator and interior AC components while replacing your original, power-robbing RV2 compressor with a light, efficient Sanden-style compressor rated for continuous duty at 6,000 RPM! Includes condenser, compressor, mounting brackets, idler pulleys, all hoses/lines, thermostat, expansion valve, o-rings, hardware, refrigerant tape, and filter-drier. Compatible with R134a.

Important: For factory AC applications w/original pulleys. Not for 6-Pack or Shaker engines.

Note: *Top condenser fitting points up. *Top condenser fitting points to side.

Special order; must be pre-paid.

B-Body Models

Small Block		
MB184526* 1968-70 w/PS, early 1970	804.99 set	
MB184526* 1970 late 1970	804.99 set	
MB184531 1973-74	804.99 set	

Big Block		
MB184527* 1968-70 early 1970	804.99 set	
MB184527* 1970 late 1970	804.99 set	
MD646755 1971-72	804.99 set	

F-Body Models

Big Block		
MD646755 1970-74	804.99 set	

New!



B4620

1969-72 Air Conditioning Belts

Reproduction air conditioning belts for 1969-72 models. Officially licensed by Mopar, they feature indented imprinting of the correct Mopar part numbers, manufacturer's code, appropriate date code, Chrysler Pentastar logo and they are cloth wrapped. These authentic looking reproductions are the finishing touch to any serious restoration and a great way to gain points over your car show competitors. You don't want something as simple as a worn or incorrect belt to keep you from winning your next trophy, and you certainly don't want to be left stranded on the way to your next show. Officially licensed by Mopar!

Note: *2 required.

Barracuda

B4620 1969	225, 273, 318, 340	36.99 ea
B4732* 1970	Alh/AC 318, 340, 360	36.99 ea
B4730E 1971	318, 340, 360	36.99 ea
B4731E 1971	383, 440	36.99 ea
B4732E 1971	Alh/AC 318, 340, 360	36.99 ea
B4734E 1971	Alh/AC 383, 440	36.99 ea
B4770* 1972	Alh/AC 318, 340, 360	36.99 ea

Belvedere, Charger, Coronet, Road Runner

B4620 1969	225, 273, 318, 340	36.99 ea
B4623* 1969	Alh/AC 383, 440	36.99 ea
B4734* 1970	Alh/AC 383, 440	36.99 ea
B4730E 1971	318, 340, 360	36.99 ea
B4731E 1971	383, 440	36.99 ea
B4734E 1971	Alh/AC 383, 440	36.99 ea
B4771* 1972	400, 440	36.99 ea

Belvedere, Charger

B4732* 1970	Alh/AC 318, 340, 360	36.99 ea
B4732E 1971	Alh/AC 318, 340, 360	36.99 ea
B4770* 1972	Alh/AC 318, 340, 360	36.99 ea

Coronet, Road Runner

B4732* 1970	Alh/AC 318, 340, 360	36.99 ea
B4732E 1971	Alh/AC 318, 340, 360	36.99 ea

Charger, Coronet, Road Runner

B4770* 1972	Alh/AC 318, 340, 360	36.99 ea
-------------	----------------------	----------

Challenger

B4732* 1970	Alh/AC 318, 340, 360	36.99 ea
B4734* 1970	Alh/AC 383, 440	36.99 ea
B4730E 1971	318, 340, 360	36.99 ea
B4731E 1971	383, 440	36.99 ea
B4732E 1971	Alh/AC 318, 340, 360	36.99 ea
B4734E 1971	Alh/AC 383, 440	36.99 ea
B4770* 1972	Alh/AC 318, 340, 360	36.99 ea

Chrysler Passenger Car

B4732* 1970	Alh/AC 318, 340, 360	36.99 ea
B4731E 1971	383, 440	36.99 ea
B4732E 1971	Alh/AC 318, 340, 360	36.99 ea
B4770* 1972	Alh/AC 318, 340, 360	36.99 ea
B4771* 1972	Alh/AC 400, 440	36.99 ea

Dart

B4620 1969	Alh/AC 225, 273, 318, 340	36.99 ea
B4732 1970	Alh/AC 318, 340, 360	36.99 ea
B4730E 1971	318, 340, 360	36.99 ea
B4732E 1971	Alh/AC 318, 340, 360	36.99 ea
B4770 1972	Alh/AC 318, 340, 360	36.99 ea

Plymouth Only

B4620 1969	225, 273, 318, 340	36.99 ea
------------	--------------------	----------

Dodge/Plymouth

B4732* 1970	Alh/AC 318, 340, 360	36.99 ea
B4730E 1971	318, 340, 360	36.99 ea
B4731E 1971	383, 440	36.99 ea
B4732E 1971	Alh/AC 318, 340, 360	36.99 ea
B4770* 1972	Alh/AC 318, 340, 360	36.99 ea
B4771* 1972	Alh/AC 400, 440	36.99 ea

Valiant

B4620 1969	225, 273, 318, 340	36.99 ea
B4732 1970	318, 340, 360	36.99 ea
B4730E 1971	318, 340, 360	36.99 ea
B4732E 1971	Alh/AC 318, 340, 360	36.99 ea
B4770* 1972	Alh/AC 318, 340, 360	36.99 ea

AC, HEATER & COOLING SYSTEM

AC Upgrade Components



AP4510

Sanden AC Compressors

When retrofitting a modern AC system, Sanden SD508 and SD7H AC compressors are the first choice. Not only do they produce colder air than the original compressors, they require less horsepower to turn. Rated for continuous duty at 6,000 RPM. All compressors feature a 2-groove V-belt clutch.

Important: For use with R134A systems only.

SD508 AC Compressors

AP4510 natural finish..... 204.99 ea

Z6161A polished finish..... 264.99 ea

SD7H AC Compressors

AP7312 natural finish..... 224.99 ea



1967-76 383, 400, 440 w/AC Sanden SD508 AC Compressor Bracket

Upgrade the power-robbing factory AC compressor in your Mopar with an efficient Sanden. This set is for models with 1967-76 383, 400 or 440 engines with factory AC and iron water pump housing. Mounts only Sanden SD508 compressors. Fits most standard, shaker, and aftermarket hoods.

MN410701 1967-76 iron water pump... 134.99 set

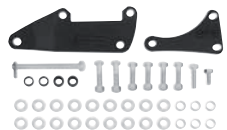

1967-76 361-440 w/AC Sanden SD508 AC Compressor Bracket

Upgrade the power-robbing factory AC compressor in your Mopar with an efficient Sanden. This set is for models with 1967-76 B & RB engines with factory AC and aluminum water pump housings or pre-1966 iron water pump housings. Mounts only Sanden SD508 compressors. Fits most standard, shaker, and aftermarket hoods.

MN410702 1967-76 big block..... 84.99 set

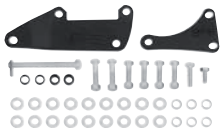

1967-71 Hemi w/AC Sanden SD7H AC Compressor Bracket

Upgrade the power-robbing factory AC compressor in your Mopar with an efficient Sanden. This set is for models with 1967-71 426 Hemi engines with factory AC and aluminum water pump housing. Mounts only Sanden SD7H compressors. Fits most standard, shaker, and aftermarket hoods.

MN410702 1967-71 aluminum pump. 84.99 set

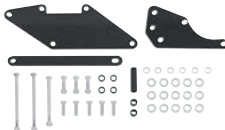

1970-76 318-360 w/AC Sanden SD7H AC Compressor Bracket

Upgrade the power-robbing factory AC compressor in your Mopar with an efficient Sanden. This set is for models with 1970-76 273-360 small block engines with factory AC and original RV2 or C171 compressor. Mounts only Sanden SD7H compressors. Fits most standard, shaker, and aftermarket hoods.

MN410703 1970-76 small block..... 109.99 set

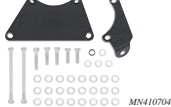

MN410704

1970-76 318-360 w/AC Sanden SD7H AC Compressor Brackets

Add an efficient Sanden AC compressor to your Mopar without factory AC with these upgrade sets. This set is for models with 1970-76 318-360 small block engines without factory AC and with or without power steering. Mounts only Sanden SD7H compressors. Fits most standard, shaker, and aftermarket hoods.

Important: This bracket set is specifically designed for 6 lbt intakes or other intakes that do not feature the front bolt boss on top of the intake. Cannot be used in conjunction with intakes that feature the front bolt boss.

MN410704 1970-76 with PS..... 109.99 set

MN410705 1970-76 without PS..... 209.99 set

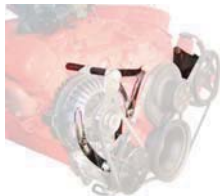

mounting location

1967-76 Big Block & Hemi w/o AC Sanden SD7H AC Compressor Brackets

Add an efficient Sanden AC compressor to your Mopar without factory AC with this upgrade set. This set is for models with 1967-76 big block or Hemi engines without factory AC and with power steering. Mounts only Sanden SD7H compressors. Fits most standard, shaker, and aftermarket hoods. This bracket mounts the compressor under the alternator, hidden away from view.

Note: This compressor bracket can not be used in conjunction with mechanical fuel pumps.

MN410706 1967-76 with PS..... 199.99 set

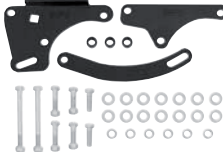

1967-76 Big Block & Hemi w/o AC Sanden SD7H AC Compressor Brackets

Add an efficient Sanden AC compressor to your Mopar without factory AC with this upgrade set. This set is for models with 1967-76 big block or Hemi engines without factory AC and without power steering. Mounts only Sanden SD7H compressors. Fits most standard, shaker, and aftermarket hoods. This bracket mounts the compressor in the stock location.

Note: This compressor bracket can not be used in conjunction with mechanical fuel pumps.

MN410707 1967-76 without PS..... 159.99 set

AC Components



MAR20226

1966-76 AC Condensers

The condenser, along with the evaporator, is a fundamental part of the AC system. Over time, condensers develop leaks and are damaged by road debris, reducing their efficiency. These OE-style tube-and-fin design condensers modern parallel-flow condensers are both designed as direct replacements for the original to keep your AC blowing cold.

A-Body			
MAR20225	1966	OE style	Plymouth only..... 281.99 ea
MAR20226	1967-72	OE style	Dart/Valiant/Scamp..... 281.99 ea
MAR20226	1967-69	OE style	Barracuda..... 281.99 ea
MAR20227	1973-74	OE style	all..... 281.99 ea
MAR20228	1975-76	OE style	all..... 281.99 ea
B-Body			
MB184511	1966-70	OE style 281.99 ea
MB184512	1966-70	OE style	high efficiency parallel flow..... 304.99 ea
MB184513	late 1970	OE style 281.99 ea
MD646742	1971	OE style	V8..... 281.99 ea
MD646743	1971	OE style	V8, high efficiency parallel flow..... 304.99 ea
MB184515	1973-74	OE style 281.99 ea
MB184516	1973-74	OE style	high efficiency parallel flow..... 304.99 ea
E-Body			
MD646742	1970-71	OE style	V8..... 281.99 ea
MD646743	1970-71	OE style	V8, high efficiency parallel flow..... 304.99 ea
ME175920	1972-74	OE style 281.99 ea
ME175921	1972-74	OE style	high efficiency parallel flow..... 304.99 ea

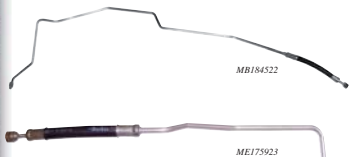

1967-74 AC Liquid Lines and Hoses

These replacement liquid lines and hoses connect the condenser and the expansion valve on the evaporator. Extreme under-hood temperatures cause these hoses to deteriorate over time. These new barrier-type hoses are compatible with R12 and required when converting to R134a.

*Note: *Shipped oversize.*

B-Body			
MB184520*	1967-70	condenser to filter-drier line	49.99 ea
MB184521	1967-70	filter-drier to expansion valve hose	41.99 ea
MD646753	1971	condenser to filter-drier line	49.99 ea
MB184522*	1972-74	filter-drier to expansion valve line	114.99 ea
E-Body			
ME175922	1970	filter-drier to expansion valve hose	49.99 ea
MD646753	1970-71	condenser to filter-drier line	49.99 ea
ME175923	1971-74	filter-drier to expansion valve hose	49.99 ea
ME175924*	1972-74	condenser to filter-drier line	49.99 ea



MD646746

1961-76 RV2 AC Compressor & Components

Restore your RV2 AC compressor with these quality gasket and seal sets or replace it with a remanufactured compressor to keep your AC system at peak efficiency.

AC Compressor			
MD646746	1961-76	compressor.....	159.99 ea
Repair Components			
MD646747	1961-76	shaft seal set.....	44.99 set
MD646748	1961-76	gasket set.....	35.99 set
MD646749	1961-76	manifold gaskets.....	6.99 set

These High-Efficiency Cores Will Keep Your AC Blowing Cold!



MB184510



MD646741

1966-74 B & E-Body Evaporator Cores

The evaporator, along with the condenser, is a fundamental part of the AC system. To keep your AC blowing cold, replace your aging evaporator with a new high-efficiency core, especially when converting to R-134a.

MB184510	1966-70	B-Body.....	304.99 ea
MD646741	1971-74	B-Body.....	241.99 ea
MD646741	1970-74	E-Body.....	241.99 ea



MD2237



MD2238

1967-72 AC Data Tag

Air conditioning data tag for 1967-72 A, B and E-Body models. This aluminum tag is screwed on to the air compressor and includes mounting hardware.

MD2237	1967-72	A-Body	charge - 2 lbs. 14 oz.	14.99 ea
MD2238	1967-72	B-Body	charge - 3 lbs. 6 oz.	14.99 ea
MD2238	1970-72	E-Body	charge - 3 lbs. 6 oz.	14.99 ea

AC Components



1968-70 B-Body AC Vacuum Canister

Reproduction AC vacuum canister for 1968-70 B-Body models. This canister holds constant vacuum, allowing your AC and heating system to operate continuously as your engine vacuum fluctuates.

MB184519 1968-70 81.99 ea



MB184518

1966-74 Heater Bypass Valves

This replacement bypass valve regulates the flow of coolant to the heater core for 1966-74 Mopar models originally equipped with AC.

MB184518 1966-70 B-Body repro..... 71.99 ea

MD646754 1972-74 B-Body OEM..... 174.99 ea

MD646754 1970-74 E-Body OEM..... 174.99 ea



MD646751

1960-75 AC Filter/Dryers

Replacement filter/dryer assemblies for all 1960-75 Mopar muscle car applications. The filter-drier must be replaced any time the AC system is opened and exposed to the atmosphere. Connectors are either male & male or male & female.

MD646750 1960-70 male & male 79.99 ea

MD646751 1971-75 male & female 79.99 ea



1965-74 AC Expansion Valve

Replacement expansion valve for 1965-74 Mopar muscle car applications. This valve is mounted at the evaporator inlet and regulates incoming refrigerant.

MD646752 1965-74 64.99 ea



1963-76 AC Heater O-Ring Set

This green HBNR o-ring set will replace any damaged or missing AC o-rings. This 14 piece set includes o-ring lubricant and fits all 1963-76 models with air conditioning.

MD7089 1963-76 with AC..... 7.99 set



1967-76 AC Clutch Cycling Switch

An AC clutch cycling switch is necessary when replacing a RV2 style compressor with a rotary type. Due to the high efficiency of rotary compressors, they are able to cycle on and off during operation instead of running continuously.

MN410710 1967-76 34.99 ea



1960-76 AC Low Pressure Switch

This low pressure binary switch is located on the receiver dryer and is similar to the original. Designed to shut off the AC compressor if pressure goes too high or low. For use with R134A refrigerant only; required when upgrading from R12.

MN410711 1960-76 27.99 ea



1965-74 AC Heater Control Switch

This 5-button switch controls the compressor, blower and all vacuum operated devices in the heating/AC system. Replaces worn or broken switches on A, B, and E-Body cars with air factory air conditioning.

MN960110 1965-72 A-Body 89.99 ea

MN960110 1965-72 B-Body 89.99 ea

MN960110 1970-74 E-Body 89.99 ea



MB182701

1970 B-Body AC Heater Control Vacuum Hose Sets

Replace brittle, cracked or broken heater/AC control vacuum hoses on 1970 B-Body with these sets. Each set contains all correctly-sized hoses with the correct stripes and ribs.

MB182701 1970 from firewall..... 95.99 set

MB182702 1970 complete kit..... 175.99 set



AC Hose Bubble Crimper Tool Set

When you need to fabricate hoses with special lengths, this easy-to-use bubble crimping kit gets the job done at home with professional results. Includes crimping, crimping dies for #6 (3/8"), #8 (1/2"), #10 (5/8"), #12 (3/4") fittings and an easy storage plastic carrying case.

K2469 209.99 set

Heater Components



1967-69 A-Body Heater Core

Heater core for 1967-69 A-Body models. Fits all 1967-69 Dart, 1967-69 Barracuda and 1967-69 Valiant models.

2277535 1967-69..... 79.99 ea



MP600156



MA2233

1970-76 A-Body Heater Cores

Heater core for 1970-76 A-Body models with or without AC. Fits all 1970-76 Dart, 1970-76 Duster, 1970-76 Valiant, 1971-72 Demon, 1971-76 Scamp and 1973-76 Dart Sport models.

3502462 1973-76 w/AC..... 58.99 ea
3879303 1970-76 w/o AC..... 59.99 ea



2936684

1966-76 B & E-Body Heater Cores

Replacement heater cores for 1966-76 B & E-Body models with or without AC.

B-Body			
MB184517	1966-70	w/AC	271.99 ea
2936684	1966-69	without AC	109.99 ea
2932999	1970	without AC	89.99 ea
2936684	1971	without AC	109.99 ea
3579171	1972-76	without AC	94.99 ea
3441180	1971-74	with AC	98.99 ea
E-Body			
3420815	1970-74	without AC	74.99 ea
3441180	1970-74	with AC	98.99 ea



MA2475

MB1681

1966-76 Heater Box Restoration Sets

Replacement heater box seal sets for various 1966-76 models. Deteriorated seals can allow water and other elements to leak into the vehicle. Replace all seals with these complete sets. Made in the USA.

A-Body - Without AC			
MA2475	1967-72		44.99 set
MA4810	1973-76		44.99 set
A-Body - With AC			
MA4811	1967-72		79.99 set
MA4812	1973-76		74.99 set
B-Body - Without AC			
MB1680	1966-70		39.99 set
MB1681	1971-74		44.99 set
B-Body - With AC			
MB1916	1966-70		104.99 set
MB1917	1971-74		74.99 set
E-Body - Without AC			
ME8133	1970-74		44.99 set
E-Body - With AC			
ME8160	1970-74		74.99 set



1970-74 E-Body Heater Core Housing Cover

Heater core housing cover for 1970-74 E-Body models without AC.

ME1654 1970-74 w/o AC..... 189.99 ea



1970-74 E-Body Temperature Control Cable

Replace that worn, frayed cable with this factory style replacement and properly connect the levers to the control valve on the firewall.

MN1756 1970-74 w/AC, 71"..... 52.99 ea



MB184611

1966-74 Heater Box Screw Sets

Replacement heater box screw set for various 1966-74 models without air conditioning. This stainless set includes everything you need to service your Mopar's heater box, with the correct sizes and head styles. Made in the USA.

MB184611 1966-70 B-Body..... 16.99 set
MD600330 1971-74 B-Body..... 7.99 set
MD600330 1970-74 E-Body..... 7.99 set



MA820220

1964-74 Heater Box Clip Sets

Replacement heater box clip set for various 1964-74 models without air conditioning. Make it easier to reassemble your heater box assembly with a full set of heater box clips. Made in the USA.

MA820220 1964-72 A-Body..... 27.99 set
MD600346 1971-74 B-Body..... 34.99 set
MD600346 1970-74 E-Body..... 34.99 set



Heater Components



1962-65 B-Body Heater Core Grommets

Replacement heater core grommets for 1962-65 B-Body models. Sold as a pair.
MB1682 1962-65 29.99 pr



MB184610

MB184612



1964-74 Blower Motor Vent Tubes

Replacement blower motor vent tube for all 1964-74 Mopar models. Available for vehicles with or without air conditioning. Made in the USA.

A-Body			
MAR20221	1964-72	w/AC.....	21.99 ea
B-Body			
MB184610	1966-70	w/AC.....	18.99 ea
MB184612	1966-70	w/o AC.....	21.99 ea
MD600329	1971-74	w/AC.....	21.99 ea
MB184613	1971-74	w/o AC.....	29.99 ea
E-Body			
MD600329	1970-74	w/AC.....	21.99 ea



MD2244

1966-74 Heater Hose Sets

Reproduction heater hose sets for various 1966-74 models. Each set includes two correctly grooved & marked hoses cut in 4 ft. lengths with spring clamps. AC equipped cars have extra length and curved bypass hose with correct lettering & reinforced spring for heater core. All sets include two aluminum tie straps.

Models With AC			
MD2243	1966	A/B-Body.....	74.99 set
MD2244	1967	A/B-Body.....	74.99 set
MD2245	1968	A/B-Body.....	74.99 set
MD2246	1969	A/B-Body.....	84.99 set
MB2348	1970	B-Body.....	84.99 set
MD2247	1970	A/E-Body.....	74.99 set
MB2349	1971	B-Body.....	74.99 set
ME1657	1971	E-Body.....	74.99 set
MD2248	1972	A/B/E-Body.....	74.99 set
MD2249	1973	A/B/E-Body.....	74.99 set
MD2250	1974	A/B/E-Body.....	99.99 set
Models Without AC			
MD2251	1966	A/B-Body.....	84.99 set
MD2252	1967	A/B-Body.....	84.99 set
MD2253	1968	A/B-Body.....	84.99 set
MD2254	1969	A/B-Body.....	79.99 set
MB2350	1970	B-Body.....	74.99 set
MD2255	1970	A/E-Body.....	99.99 set
MB2351	1971	B-Body.....	99.99 set
ME1658	1971	E-Body.....	99.99 set
MD2256	1972	A/B/E-Body.....	99.99 set
MD2257	1973	A/B/E-Body.....	99.99 set
MD2258	1974	A/B/E-Body.....	94.99 set



1967-74 Heater Box To Cowl Rubber Seal

Replacement heater box to cowl rubber seal for various 1967-74 B-Body, and E-Body models. Manufactured to original specifications out of the correct rubber material. Made in the USA.

B-Body			
MD7088	1967-70	without AC.....	17.99 ea
MD7088	1971-74	with AC.....	17.99 ea
E-Body			
MD7088	1970-74	with AC.....	17.99 ea



1963-68 Inner Fender Heater Hose Bracket

Heater hose bracket for 1963-1966 A-Body and 1966-1968 Hemi B-Body models. This bracket bolts onto the right inner fender panel above the shock tower. Manufactured using correct 18 gauge stainless steel.

MD2229	1963-66	A-Body.....	9.99 ea
MD2229	1966-68	B-Body Hemi.....	9.99 ea



1960-68 Big Block

Alternator Heater Hose Bracket w/o AC

Heater hose bracket for all 1960-68 big block and Hemi models without AC. This bracket bolts onto the alternator triangle support bracket. Manufactured from correct gauge steel, cadmium-plated and thermoplastic coated. Made in USA.

MD2223	1960-68	big block w/o AC.....	19.99 ea
--------	---------	-----------------------	----------

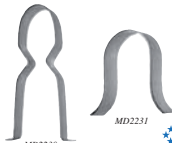

MD2231

MD2230



1967-68 Valve Cover Heater Hose Brackets

Heater hose bracket for all 1967-68 big block models. These brackets clip onto the RH valve cover. Manufactured from correct 18 gauge stainless steel. Made in USA.

MD2230	1967-68	big block w/AC.....	14.99 ea
MD2231	1967-68	big block w/o AC.....	7.99 ea



1967-68 Alt Heater Hose Bracket w/AC

Heater hose bracket for all 1967-68 big block models with AC. This bracket bolts to the alternator on top of the adjusting strap. Manufactured from correct gauge steel, zinc plated and thermoplastic coated. Made in USA.

MD2233	1967-68	big block w/AC.....	21.99 ea
--------	---------	---------------------	----------



1969-70 Inner Fender Heater Hose Bracket

Heater hose bracket for 1969 A-Body and 1969-70 B-Body big block models. This bracket bolts on to the right inner fender panel above the shock tower. Manufactured from correct gauge steel and cadmium plated. Made in USA.

MD2228	1969-70	big block.....	14.99 ea
--------	---------	----------------	----------



MD2226

1969-74 Big Block Alt Heater Hose Bracket

Heater hose brackets for all 1969-74 big block and Hemi models. These brackets bolt to the alternator triangle support bracket. Manufactured from correct gauge steel, cadmium plated and thermoplastic coated. Made in USA.

MD2226	1969-74	big block/Hemi.....	19.99 ea
MD2235	1969-74	big block w/AC.....	19.99 ea



1970-76 Cylinder Head Heater Hose Bracket

Heater hose bracket for all 1970-76 small block Mopar vehicles. This hose bracket mounts to the RH cylinder head. Manufactured from 16 gauge galvanized steel and thermoplastic coated. Made in USA.

MD2227	1970-76	small block.....	19.99 ea
--------	---------	------------------	----------



1960-76 Heater Hose Tie Strap

Heater hose tie strap for all 1960-76 models. This strap has various purposes, most commonly used to hold the heater hoses together. Manufactured from correct gauge aluminum for an original appearance. Made in USA.

MD2234	1960-76.....	5.99 ea
--------	--------------	---------

High Performance Crate Engines from Mopar Performance!

Choose your Level of Performance with Small Block, Big Block and Hemi Engines from Mopar!

Mopar Performance Crate Engines

Your classic muscle car commands horsepower and performance, and Mopar Performance crate engines deliver.



Crate engine assemblies not used in competition are warranted for "parts only," AS DELIVERED against defects in materials or workmanship for 90 days from the date of purchase. The following parts, if defective, will be replaced on an exchange basis for 90 days: engine blocks and all internal parts; cylinder head assemblies; intake manifold; core plugs; valve covers; oil pan; timing gear; water pump; gaskets and seals. See your dealer for a copy of the limited warranty, which contains additional terms and limitations.

Important: These engines are for off-highway use only and may not be legal for use in pollution-controlled vehicles. Horsepower and torque ratings based on test engine. Ratings may vary on individual engines.



340 Six-Pack - 330 HP

This crate engine uses proven components to deliver a solid 330 horsepower and 340 ft.-lbs. torque in a package that fits in most muscle cars.

Features
340 block with 4-bolt mains
Aluminum "LA" cylinder heads
Heavy duty cast crankshaft

Specifications
Displacement: 340 cubic inch
Bore x Stroke: 4.040" x 3.310"
Cams: Hydraulic, 292°/292° duration, 0.508" lift
Oil Pan: Stock style front sump
Compression: 10:1

Important: Carburetor not included.
Note: Shipped track freight.
No further discounts apply.



12,419.99 ea



360 Magnum - 405 HP

This high output Magnum 360 crate engine produces 405 horsepower at 5,900 rpm with 400 ft.-lbs. at 4,600 rpm.

Features
HP Magnum block
Magnum Aluminum Cylinder Heads
Mopar Performance electronic ignition
Single Plane M1 4-bbl aluminum intake manifold (taller than stock-check clearance)
Center sump oil pan (Commando style)

Specifications
Displacement: 360 cubic inch
Bore x Stroke: 4.040" x 3.310"
Cams: Hydraulic Roller, 288°/292°
Valves: Stainless steel, 2.02" intake, 1.60" exhaust
Compression: 10:1

Important: Optimized for 750 CFM carburetor and symmetrical, neutrally balanced torque converter or flywheel (sold separately). Does not include accessory brackets. Not designed for use with Air Conditioning or factory MPI.

Note: Shipped track freight.
No further discounts apply.



11,359.99 ea

MN1971



410 Six Pack - 470 HP

Mopar's 410 Stroker small-block features a new aluminum "Six Pack" intake manifold and Mopar cast aluminum valve covers. With 470 horsepower and 490 ft.-lbs. of torque, this crate engine will impress at the drag strip and on cruise nights.

Features
340 block with 4-bolt mains
Aluminum LA Cylinder Heads
High-lift Hydraulic Camshaft
Heavy-Duty Forged Stroker Crankshaft
Eight-Quart Center Sump Oil Pan

Specifications
Displacement: 410 cubic inch
Bore x Stroke: 4.040" x 4.000"
Cams: Hydraulic, 292°/292°
Valve Size: 2.02" Intake, 1.60" Exhaust
Compression: 10:1

Important: Carburetor not included.
Note: Shipped track freight.
No further discounts apply.



13,569.99 ea

MN1975



500 Wedge - 505 HP

This Wedge crate engine packs 505 horsepower and 590 ft.-lbs. of torque into 500 cubic inches, more power than any production Wedge motor.

Features
Heavy Duty Cast-Iron Block with Cross-bolted mains
Cast Iron Cylinder Heads
Flat Top Cast Aluminum Pistons
Forged Crankshaft
Premium Double Roller Timing Chain
Chrome Front Cover
Single-Plane M1 Aluminum Intake Manifold
Cast Aluminum Valve Covers

Specifications
Displacement: 500 cubic inch
Bore x Stroke: 4.380" x 4.150"
Cams: Hydraulic, 292°, 0.509"/0.509"
Valves: Stainless, 2.14" Intake, 1.81" Exhaust
Compression: 9.0:1

Note: Shipped track freight.

No further discounts apply.

MN1979



11,279.99 ea



440 Super Commando - 530 HP

How does big block power from a small block package sound? That's 530 horsepower and 540 ft.-lbs. using pump gas, to be specific. This 440 Super Commando is a crate motor to be reckoned with.

Features
340 Siamese Block with 4-bolt mains
Aluminum Cylinder Heads
Single Plane 4-bbl Intake Manifold
Forged Crankshaft and Pistons

Specifications
Displacement: 440 cubic inch
Bore x Stroke: 4.185" x 4.000"
Cams: Hydraulic 251°/257° @ .050", 603" Lift
Valves: 2.080"/1.600" Stainless, with 5/16" Stems
Compression: 10.0:1

Oil Pan: Eight-quart Center Sump Street/Strip
Connecting Rods: Forged 6.123"

Rocker Arms: Aluminum Roller with 1.6:1 Ratio

Important: Carburetor and oil cleaner not included.

Note: Shipped track freight.

No further discounts apply.

MN1977



14,579.99 ea

High Performance Crate Engines from Mopar Performance!

Choose your Level of Performance with Small Block, Big Block and Hemi Engines from Mopar!

Four Levels of Hemi Performance! Choose From a Streetable
465 HP or Blast Down the Track with 640 Tire-Melting Horsepower!



MN1978

426 Hemi - 465 HP

Enjoy 465 horsepower and 465 ft.-lbs. of torque with this classic 426 Hemi, plenty of classic power to move you!

Features

- Cast Iron Block with Cross-bolts mains
- Cast Iron Cylinder Heads
- Forged Crankshaft and Pistons
- Premium Double Roller Timing Chain and Sprockets
- Performance Electronic Distributor
- Six quart Center Sump Oil Pump 1970-71 B-body/E-Body Style
- Dual Plane 4bbl Aluminum Intake Manifold
- Chrome Valve Covers

Specifications

- Displacement:** 426 cubic inch
- Bore x Stroke:** 4.250" x 3.750"
- Camshaft Lift:** 0.409"/0.483"
- Camshaft Duration:** 234° at .050"
- Valves:** Stainless, 2.25" Intake, 1.94" Exhaust
- Compression:** 8.7:1
- Important:** This engine is optimized for a 4-barrel 750 CFM carburetor and 2" exhaust headers.
- Note:** Shipped truck freight.

MN1976 17,239.99 ea

472 Hemi Crate Engine - 530 HP

This 472 Hemi, with an even 530 horsepower and 530 ft.-lbs. torque, is an impressive step from the familiar 426 Hemi. Plenty of power for any Mopar.

Features

- Cast Iron Block with Cross-bolts mains
- Cast Iron Cylinder Heads
- Chrome Valve Covers
- Aluminum Dual-Plane M1 Four-barrel Intake Manifold
- Heavy-Duty Single Valve Springs with Dampers
- Premium Valve Stem Seals
- Forged Steel Crankshaft
- Premium Double Roller Timing Chain and Sprockets
- High-Performance Electronic Distributor

Specifications

- Bore x Stroke:** 4.250" x 4.150"
- Camshaft:** 301" Hydraulic, 248° duration @ .050" - 0.582"/0.563" Lift
- Valves:** Stainless Steel, 2.25" Intake, 1.94" Exhaust
- Oil Pan:** 6-Quart Center Sump (70-71 B & E-Body Style)
- Compression:** 9.0:1
- Important:** This engine is optimized for an 850 CFM vacuum secondary carburetor and 2" exhaust headers.
- Note:** Shipped truck freight.

MN1978 18,299.99 ea



MN1981

528 Hemi - 610 HP

610 horsepower and 650 ft.-lbs. of torque from a 528 cubic inch Hemi.

Features

- Cast Iron Block
- Aluminum Cylinder Heads
- Forged Crankshaft and Pistons
- Premium Double Roller Timing Chain
- Dual Plane M1 Aluminum Intake Manifold
- Cast Aluminum Valve Covers

Specifications

- Displacement:** 528 cubic inch
- Camshaft:** Hydraulic, 292°, 0.524"/0.543"
- Valves:** Stainless, 2.25" Intake, 1.94" Exhaust
- Compression:** 10.25:1
- Important:** Engine comes with a four barrel manifold included. Cross ram intake system and carburetor not included.
- Note:** Shipped truck freight.

MN1980 18,949.99 ea

528 Hemi Crate Engine - 640 HP

All other factors held equal, there's no replacement for displacement. That's why this huge 528 Hemi Crate Engine was developed to crank out a whopping 640 horsepower and 612 ft.-lbs. of torque! For the pinnacle of Mopar crate engine performance, look no further.

Features

- Black Cast Aluminum Valve Covers
- Aluminum Cylinder Heads
- Heavy-Duty Single Valve Springs
- Premium Material Valve Stem Seals
- Aluminum Single Plane Four-barrel Intake Manifold
- Forged Steel Crankshaft and Pistons
- High-Performance Electronic Distributor
- Precision Double Roller Timing Chain and Sprockets
- Chrome Front Cover

Specifications

- Displacement:** 528 cubic inch
- Bore x Stroke:** 4.500" x 4.150"
- Block:** Siamese Bore, Cast Iron with Cross-Bolts Mains
- Camshaft:** Hydraulic 251°/257° @ .050", 603" Lift
- Valves:** Stainless Steel 2.25" Intake 1.94" Exhaust
- Compression:** 10.0:1
- Oil Pan:** Six-quart Center Sump Street/Strip Connecting Rods: Forged 6.123"

Important: This engine is optimized for an 850 or 900 CFM carburetor and 2-1/4" exhaust headers.

Note: Verify hood clearance for intake manifold. Shipped truck freight. No further discounts apply.

MN1974 19,264.99 ea



MN1974

6.1L (370) Hemi - 425 HP

Horsepower and torque right out of the crate! The 370 Hemi is available in two forms, one (MN2070) with factory wire harness and throttle body, the other (MN1972) with billet fuel rails and integral pressure gauge, cable operated 80 mm throttle body, and programmable EMS kit.

Features

- 6.1 Liter (370 cubic inches)
- 425 horsepower, 430 ft. lbs of torque
- Electronic Fuel Injection
- Dyno tested, ready to run
- Note:** Shipped truck freight.
- No further discounts apply.
- MN1972 w/upgraded FI & EMS kit..... 10,649.99 ea
- MN2070 with basic FI..... 6131.99 ea

392 Hemi Crate Engine - 540 HP

Precision balanced rotating assembly, distributorless Coil-On-Plug (COP) ignition, this 392 Hemi is modern muscle for any Mopar, and is available with electronic fuel injection (EFI) or carbureted. With EFI, this Hemi is good for 525 HP and 510 lb-ft of torque (MN1974). With a Holley 870 cfm carburetor, you can expect 540 hp and 490 lb-ft of torque (MN1973). Both come with a pre-programmed engine controller to ensure compatibility with virtually any vehicle.

Features

- Deep-skirted cast iron block with cross-bolts mains
- 4140 forged steel crankshaft
- Hydraulic roller camshaft
- Premium tri-metal engine bearings
- SFI-approved competition crankshaft damper
- 4130 forged steel I-beam 6,200" connecting rods
- CNC-ported aluminum twin-plug cylinder heads
- Aluminum single plane high-rise intake manifold
- "Plug and play" wiring harness

Specifications

- Displacement:** 392 cubic inch
- Bore x Stroke:** 4.055" x 3.795"
- Camshaft Duration:** 279°/285° (@ .006")
- Camshaft Lift:** 0.584" Intake, 0.552" Exhaust
- Valves:** Stainless 2.100" Intake, 1.600" Exhaust
- Compression:** 10.5:1

Engine Management Features

- Windows software
- Built-In Peak and Hold Injector Drivers
- Built-In Direct Drive Ignition
- Built-In Dual Wideband UEGO Controllers (UEGO sensors not required or included)
- Sequential Fuel Injection
- Soft Cut Rev Limiters
- Onboard 512 kb Datalogger
- Definable Knock Control
- Full Idle Control
- Compatible with Factory Sensors

Note: Shipped truck freight.

No further discounts apply.

MN1973 with EFI..... 20,999.99 ea

MN1974 with carburetor..... 20,519.99 ea

ATK Remanufactured Engines



More than 150 processes involved in remanufacturing an ATK engine. Featured procedures include:

- Engine blocks magnafluxed, bored, precision-honed and mains line-honed.
- Camshaft bearings line-bored for accurate center-to-center clearance.
- Engine blocks and cylinder heads precision surfaced.
- Cylinder heads magnafluxed and machined for three-angle valve seats.
- Crankshafts stress-relieved, precision ground and micro-polished.
- Camshafts precision ground or replaced with new.
- Each engine tested (most hot-run tested) for compression, oil pressure, oil leaks, engine noise and general operating condition before shipment.

ATK Remanufactured Engine Warranty Information:

At Classic Industries™, we know that supplying a great product is only part of the job. The staff at ATK is a group of dedicated professionals whose only job is to support you, the Classic Industries™ customer. From the moment you call ATK, whether to request technical assistance or inquire about their warranty, they are dedicated to providing solutions and support. That's the ATK promise. Classic Industries™ and ATK have always been leaders in innovation, offering products, warranties and programs that have redefined the industry. That leadership is evident in our products and our support. ATK warranties to the original purchaser that each engine sold by Classic Industries™ shall be free of defects in material and workmanship under normal use and with periodical maintenance as set forth by the original manufacturer subject to the following terms and conditions.

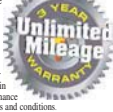

Product Replaced Under Warranty:

Product replaced under warranty carries the remainder of the original product's warranty term.

Standards:

Subject to the limitations listed herein, ATK, at its option, shall repair or replace a product within the warranty term after determination by ATK that the product or component is to be returned to ATK for inspection. Products not returned to ATK will not be warranted. All repairs and/or replacements covered by this warranty must be authorized by ATK. Unauthorized repairs will not be paid.

Limitations:

- Damage as a result of OVERTIGHTING, LACK OF LUBRICATION, Fuel Wash or Contamination.
- Damage resulting from PRE-IGNITION or DETONATION. This includes but is not limited to: melted or broken pistons, broken piston rings, damaged cylinder heads, leaking head gaskets, etc. For more information regarding pre-ignition and detonation please contact our Customer Service Department.
- Repair or replacement required as a result of any accident or misuse.
- Repair or replacement of any accessory or service item, including specifically but not limited to: all components of the cooling, fuel, electrical and ignition systems in addition to all belts, hoses and filters.
- Any product used for competition racing or related purposes.
- Any product for which a device or accessory not conforming to original manufacturer's specifications has been installed.
- Any product on which periodic maintenance services required by the original manufacturer have not been performed.

Limited Liability:

ATK's liability under this warranty is limited solely to the repair or replacement of defective product. ATK shall not be liable for any incidental, special, consequential or exemplary damages, including but not limited to rental cars, towing fees or for any service not expressly provided for herein, relating to or arising from the ATK product.

Limited Warranty:

This warranty is given in lieu of all other warranties, expressed or implied, including any warranty of merchantability, or fitness for a particular purpose, on the part of ATK or the dealer installing the engine. No dealer nor any agent or employee thereof, is authorized to extend or modify this warranty.

Labor Payments:

ATK authorized repairs will be compensated at a rate not to exceed 100% of the applicable flat rate schedule as published by Chilton, Mitchell or Motor Repair Manuals. Hourly rates for all authorized labor claims will be paid in accordance with the original installation rate, not to exceed \$50.00 per flat rate hour. Do-it-yourself repairs and repairs performed by unlicensed repair facilities will not be reimbursed.

Additional Owner/User Obligations:

Buyer/Owner/Valves must be readjusted to manufacturer's specifications. Diagnostics component designs, cylinder head or torque may or may not be required by your particular application. Refer to factory shop manual for the proper procedure for your engine type. If for any reason you are unsure what action to take please contact our Customer Service Department at our Toll Free telephone number. First Service Between 600 Miles After Installation: Oil and oil filter must be changed, valves readjusted and cylinder heads re-torqued (refer to initial start-up instructions). Failure to perform these basic operations may result in a voided warranty.

Introducing ATK's No Fault Gold Warranty Program.

An added protection program that covers car rental, towing, an increased labor rate and fluids on all approved claims.

The No Fault Gold Warranty Program Includes:

Rental Car up to \$150!

Rental car expense reimbursed for 5 days/ \$30 per day up to \$150

Towing Up to \$100!

Towing reimbursed on approved claims up to \$100 per occurrence.

Increased Labor Rate Up to \$95 per hour

Increase labor rates to cover approved repairs up to \$95 per hour

Fluids Up to \$25!

Cost of fluids is reimbursed on approved claims up to \$25

ATK now offers the No Fault Gold Warranty Program for you to purchase in addition to the Industry Leading standard ATK warranty already included with our remanufactured engines. This added protection policy covers expenses not included in ATK's standard warranty. Coverage is based on hourly rates established by Chilton, Motor and Mitchell manuals.

ATK Gold Seal Service Agreement is an additional \$200.00

	Rental	Towing	Max. Hourly Labor Rate
NO Fault Gold Warranty Program	YES	YES	Up to \$95
Standard ATK Warranty	NO	NO	Up to \$50

How does the core charge work?

Upon ordering, you will be charged the retail price of the engine plus the core charge. When your engine arrives, you will save the crating that it is shipped in, so that you can use it to package your core. Once the core is ready to ship, you will call ATK for core pickup. ATK will then inspect the core to make sure it meets the following criteria. Providing the core meets all of the criteria, you will be refunded the core price.

Core Policy:

- All cores must be drained prior to core return.
- Fluids must be complete and in rebuildable condition.
- Core returned must be identical to the engine purchased in size and application.
- ATK reserves the right to refuse any core that has been modified or altered.

Note: Core prices can fluctuate according to supply, demand and availability. If you plan to return a core for credit, please confirm the core price with your salesperson prior to ordering. No further discounts apply.



Important: All engines come without valve covers, timing cover and oil pan unless otherwise noted. Shipped anywhere in the Continental United States for \$50.00.

Note: No further discounts apply.



Best Price

Part #	Years	C.I.D./L	C	V.I.N Code	Description	+ Core	Price
DE02	67-74	225/3.7	6	C	Non-smog, 2.157" crank hub, if 1967, check hub	250	2074.99 ea
DE12*	75-80	225/3.7	6	C,D,B	Smog, cast crank	260	1749.99 ea
DE09*	75-80	225/3.7	6	C,D,B	Non-smog, mechanical lifters	260	2074.99 ea
DE03*	67-74	318/5.2	8	E,G	Non-smog, car or truck to 3/4 ton, 14mm spark plugs	285	1839.99 ea
DE04*	75-84	318/5.2	8	E,G,H,J,K	Smog	285	1839.99 ea
DE05*	75-84	318/5.2	8	M,P,R,T,U	Smog	285	1839.99 ea
DE11*	75-84	318/5.2	8	E,G,H,J,K	Non-smog	285	1839.99 ea
DE11*	75-84	318/5.2	8	M,P,R,T,U	Non-smog	285	1839.99 ea
DE06*	71-74	360/5.9	8	F,J,K,L	Non-smog	310	1914.99 ea
DE07*	75-89	360/5.9	8	F,J,K,L,U,V,W	Smog, non-roller cam	310	1914.99 ea
DE06*	75-89	360/5.9	8	F,J,K,L,U,V,W	Non-smog, non-roller cam	310	1914.99 ea
NFWG	All				No Fault Gold Warranty Program added protection program additional to the ATK 3 Year/Unlimited Mileage Standard Warranty		225.00 ea

Note: *All engines listed with an asterisk(*) are subjected to the POWERTEST standards of ATK hot-run engine specifications, including compression, oil pressure, temperature, power, leaks, engine noise and general operating conditions before shipment.

High Performance Mopar Crate Engines from ATK

ATK has been building engines for over 75 years and has assembled a line of crate engine packages to power up your Mopar. Classic Industries' dedication to bringing the highest quality products on the market, combined with ATK's industry-leading warranty make these Mopar ATK crate engines an obvious choice. Available as a base engine for enthusiasts

with their own fuel, ignition, and top end components, a mid-dress version that needs only a fuel system, plugs, and wires, or as a complete, ready-to-run package for those who want to bolt their engine into their Mopar and hit the road. For the ultimate in Mopar crate engines, there's no better source than ATK from Classic Industries.



MN2425

440 Mopar Engine 520 HP

Responding to popular demand, ATK Performance has gathered a great combination of Edelbrock parts to make a solid 520HP/560QT engine package to power up your ride.

Important: Not eligible for the No Fault Gold Warranty Program. Not intended for marine use. Marine use voids all warranties.

Note: Product may vary from image shown. No further discounts apply.

Features

Seasoned OE 440 Block
Nodular Iron crankshaft
Hydraulic Flat Tappet camshaft
10.1 Forged Pistons
Moly rings
Scat I Beam rods with ARP rod bolts
Edelbrock Performer RPM intake
Edelbrock Aluminum 84cc Cylinder heads
Quick fuel 780cfm Carburetor
MSD Pro Billet RTR Distributor
Holley 110GPH Fuel Pump
MSD 8mm Spark Plug Wires
8" Neutral Balance Harmonic Balancer

Specifications

Displacement: 440 cubic inch
Bore x Stroke: 4.320" x 3.750"
Camshaft Duration: 238°/246° @ .50
Camshaft Lift: 0.488" Intake, 0.495" Exhaust
Compression: 10:1

Base Engine

Stage 1 engines include the oil pan, valve covers and timing cover. This is the engine to order if you already have fuel/ignition components and performance top end components to use.

MN2427 6999.99 ea

Mid Dress Engine

Stage 2 engines take the base engine package and add a performance intake manifold, distributor, water pump, balancer and flex plate. Install a performance fuel system, plugs and wires to get going.

MN2426 9299.99 ea

Complete Engine

Stage 3 engines are dyno tested, tuned, and ready to run. This engine includes everything in the Mid Dress package and adds a fuel pump and performance carburetor for a complete package.

MN2425 10,299.99 ea



MN2428

408 Mopar Stroker Engine 430 HP

This 408 stroker engine package comes with everything needed to power up your ride, including an assortment of Edelbrock parts, and 430HP/501QT.

Important: Not eligible for the No Fault Gold Warranty Program. Not intended for marine use. Marine use voids all warranties.

Note: Product may vary from image shown. No further discounts apply.

Features

Seasoned OE "A" Block
Scat Nodular Iron crankshaft
Hydraulic Flat Tappet camshaft
10.1 Forged Pistons
Moly rings
Scat I Beam rods with ARP rod bolts
Edelbrock Performer RPM intake
Edelbrock Aluminum 63cc Cylinder heads
Quick fuel 780cfm Carburetor
MSD Pro Billet RTR Distributor
Holley 110GPH Fuel Pump
MSD 8mm Spark Plug Wires
8" Neutral Balance Harmonic Balancer
Stainless Steel 1.6 Rocker arms

Specifications

Displacement: 408 cubic inch
Bore x Stroke: 4.030" x 4.040"
Camshaft Duration: 230°/236° @ .50
Camshaft Lift: 0.488" Intake, 0.491" Exhaust
Compression: 10:1

Base Engine

Stage 1 engines include the oil pan, valve covers and timing cover. This is the engine to order if you already have fuel/ignition components and performance top end components to use.

MN2430 5499.99 ea

Mid Dress Engine

Stage 2 engines take the base engine package and add a performance intake manifold, distributor, water pump, balancer and flex plate. Install a performance fuel system, plugs and wires to get going.

MN2429 6399.99 ea

Complete Engine

Stage 3 engines are dyno tested, tuned, and ready to run. This engine includes everything in the Mid Dress package and adds a fuel pump and performance carburetor for a complete package.

MN2428 7299.99 ea



360 Mopar Engine 290 HP

Looking to upgrade that worn out LA 360 engine?

This retrofitted Magnum 360 engine produces 35+ more horsepower over the LA 360 engine, benefitting from Hydraulic Roller Camshaft/Lifters. This dyno tested and tuned engine is perfect for street cruisers.

Important: Not eligible for the No Fault Gold Warranty Program. Not intended for marine use. Marine use voids all warranties.

Note: No further discounts apply.

Features

93-01 Magnum OE Block 2 bolt Main 1 pc
OE Cast Steel crankshaft
Hydraulic Roller camshaft
9.1 Hypercutted Dish Pistons
Moly rings
OE rods

Edelbrock RPM Air Gap Dual plane intake
OE Magnum 65cc Cylinder heads
Quick fuel 680cfm Carburetor
MSD Pro Billet Distributor
Must run an electric Fuel Pump
MSD 8mm Spark Plug Wires
8" External Balance Harmonic Balancer

Specifications

Displacement: 360 cubic inch
Bore x Stroke: 4.040" x 3.850"
Compression: 10:1:1

Complete Engine

This engine is turn-key, ready to run package. Includes Oil Pan, Valve Covers, Timing Cover, Performance Intake, Distributor, Water pump, Performance Carburetor, Balancer, Flex Plate, 8mm Wires and Spark Plugs.

MN2472 4849.99 ea



Motor Mounts



1962-76 Motor Mounts

Original-style motor mounts for various 1962-76 Mopar models. These rubber-insulated motor mounts are ideal for stock or lightly modified applications.

6 Cylinder Motor Mounts

A-Body			
MM2304	1962-66	170/225, RH	16.99 ea
MM2303	1962-66	170/225, LH	16.99 ea
MM2264	1967-72	170/225, RH	11.99 ea
MM2265	1967-72	170/225, LH	14.99 ea
MM2264	1970-72	198, RH	11.99 ea
MM2265	1970-72	198, LH	14.99 ea
MM2323	1973-74	198/225, RH	19.99 ea
MM2324	1973-74	198/225, LH	19.99 ea
MM2376	1973-74	198/225, insert	11.99 ea

8 Cylinder Motor Mounts

A-Body			
MM2266	1967-69	273, RH or LH	11.99 ea
MM2266	1967-72	318, RH or LH	11.99 ea
MM2266	1968-73	340, RH or LH	11.99 ea
MM2325	1973-76	318, RH	18.99 ea
MM2326	1973-76	318, LH	18.99 ea
MM2325	1974-76	360, RH	18.99 ea
MM2326	1974-76	360, LH	18.99 ea
MM2369	1973-76	318/360, insert	11.99 ea

B-Body			
MM2228	1963-66	361, RH	11.99 ea
MM2227	1963-66	361, LH	11.99 ea
MM2228	1965	273/383, RH	11.99 ea
MM2227	1965	273/383, LH	11.99 ea
MM2228	1965-66	318, RH	11.99 ea
MM2227	1965-66	318, LH	11.99 ea
MM2250	1966-68	273, RH or LH	11.99 ea
MM2250	1966-71	383, RH or LH	11.99 ea
MM2250	1966-72	318, RH or LH	11.99 ea
MM2250	1972	340, RH or LH	11.99 ea
MM2250	1972-73	400/440, RH or LH	11.99 ea
MM2325	1973-76	318, RH	18.99 ea
MM2326	1973-76	318, LH	18.99 ea
MM2325	1973	340, RH	18.99 ea
MM2326	1973	340, LH	18.99 ea
MM2325	1974	360, RH	18.99 ea
MM2326	1974	360, LH	18.99 ea
MM2369	1973-76	318/340/360, insert	11.99 ea

E-Body			
MM2250	1970-74	318/340/383, RHLH	11.99 ea

MM7901



1967-74 Heavy Duty Motor Mounts

Heavy duty motor mounts designed to provide the safety of an enclosed mount design, but also to provide a direct steel-to-steel lock-up under acceleration. Power is transmitted without excess motion and resultant power loss. Clearances for headers and other tight-fitting components can be closer due to reduced engine motion, but engine vibration and harshness during normal driving is isolated from the chassis as well as with stock motor mounts. MityMounts® appear exactly like stock motor mounts once installed. Made in USA, with a lifetime manufacturer's warranty.

MM7901	1967-73	V8 except Hemi	99.99 pr
B-Body			
MM7902	1966-73	V8 except Hemi	99.99 pr
MM7903	1966-70	Hemi	399.99 pr
MM7904	1971	Hemi	399.99 pr
E-Body			
MM7902	1970-74	V8 except Hemi	99.99 pr
MM7904	1970-74	Hemi	399.99 pr



1966-71 Hemi Motor Mounts

Motor mounts for 1966-71 Mopar B and E-Body models equipped with a Hemi engine. Each motor mount meets or exceeds factory specifications for a complete replacement.

MD2440	1966-70	LH, B-Body	129.99 ea
MN1142	1966-71	RH, all	49.99 ea
MD2441	1970-71	LH, E-Body	129.99 ea
MD2441	1971	LH, B-Body	129.99 ea



1966-71 Hemi Frame Mounts

For Hemi engines only. Metal mounts for the frame.
MD4069 1966-71 Hemi 239.99 pr



MN1962



MN1963

1967-72 A-Body Motor Swap Mounts

If the factory motor just isn't "adequate" for your 1967-72 A-Body, these engine-swap sets make it easy to remedy the problem. With these sets, you can dump that Slant 6 for a 340 or 360 small block or convert to the more powerful big block. Sets include frame mounts and motor mounts; select sets include hardware.

Slant 6 To V8 Swap Mounts			
MN1962	340-360	complete set	69.99 set
MN1963	340-360	motor mount plates	59.99 set
MN1964	B/RB	complete set	64.99 set
Small Block To B/RB Swap Mounts			
MN1965	B/RB	complete set	64.99 set
MN1966	for MN1962 or MN1963		24.99 pr
MN1968	for MN1964 or MN1965		24.99 pr



MA4695

MN9901



1962-76 Engine Swap Motor Mount Sets

Make your engine swap easier with these motor mount swap sets to position your motor in the engine bay! Made in the USA.

1962-76 Motor Swap Mount Kits

Swap out your Slant 6 for a small block, big block or Hemi V8 with these engine swap motor mount sets. Each set includes engine mount brackets, engine mounts and hardware. Motor mount conversion only; other parts required to complete conversion.

Note: Swap requires custom headers/exhaust system. Currently there are no manifolds or headers manufactured for this swap.

A-Body			
MN1940	1963-66	Slant 6 to 273-318	144.99 set
MA4695	1963-66	Slant 6 to 340-360	144.99 set
MA4696*	1963-66	Slant 6 to B/RB	194.99 set
MN1509	1967-72	Slant 6 to 273/318	159.99 set
MN1941	1967-72	Slant 6 to 340-360	159.99 set
MA4697	1967-72	Slant 6 to B/RB	159.99 set
MA4698	1967-72	small V8 to B/RB	159.99 set
MN1942	1973-74	Slant 6 to 273/318	159.99 set
MN1943	1973-74	Slant 6 to 340-360	159.99 set
MN1944	1973-74	Slant 6 to B/RB	159.99 set
MN1945	1973-74	small V8 to B/RB	159.99 set
MN1946	1973-74	B/RB to 273/318	159.99 set
MN1947	1973-74	B/RB to 340-360	159.99 set

B-Body			
MN1948	1962	273/318 to 340-360	229.99 set
MN1949	1962	small V8 to B/RB	254.99 set
MN1950	1963-65	273/318 to 340-360	144.99 set
MB6000	1963-65	small V8 to B/RB	144.99 set
MN1951	1966-70	Slant 6 to 273/318	144.99 set
MN1952	1966-70	273/318 to 340-360	144.99 set
MD7102	1966-72	small V8 to B/RB	144.99 set
MN1942	1973-76	Slant 6 to 273/318	159.99 set
MN1943	1973-76	Slant 6 to 340-360	159.99 set
MN1944	1973-76	Slant 6 to B/RB	159.99 set
MN1945	1973-76	small V8 to B/RB	159.99 set
MN1946	1973-76	B/RB to 273/318	159.99 set
MN1947	1973-76	B/RB to 340-360	159.99 set

E-Body			
MD7102	1970-72	small V8 to B/RB	144.99 set

426 Hemi Motor Swap Mount Set

This Hemi conversion set offers factory-correct motor position and race performance strength yet still retains a smooth, insulated ride. This bullet-proof spool-type mount set allows you mount a new crate or original 426 Hemi to your V8 K-member without additional fabrication, K-member modifications, or additional installation parts required. Accepts factory Hemi manifolds, works with power steering, power brakes and both automatic and manual transmissions. Includes mounts and hardware.

Note: Custom headers are required.			
MN1953*	1962-65	B-Body	259.99 set
MN9901	1966-72	B-Body	259.99 set
MN9901	1970-74	E-Body	259.99 set

Motor Mounts



MN1146



MN1932



MN1147



MN1933



MN1149



1962-75 Poly-Loc™ Engine Mounts

These revolutionary new polyurethane locking mounts offer a unique, heavy duty interlocking feature that allows engine movement about the axis of engine rotation, while providing a rugged mechanical lock to keep your engine in place under hard acceleration. Made from high quality steel, hand formed and welded, then zinc dichromate plated for corrosion resistance, these are the toughest polyurethane engine mounts on the market. Made in USA.

Note: For use with original factory brackets.

** Poly spool replacement mounts.*

A-Body

MN1146	1967-72	273/318/340/360	179.99 pr
MN1932	1967-69	B/RB	179.99 pr
MN1933*	1973-75	273/318	179.99 pr
MN1934*	1973-75	340/360	179.99 pr
MN1935*	1973-75	B/RB	179.99 pr

B-Body

MN1147	1962-65	sm block/big block	219.99 pr
MN1148	1966-70	426 Hemi	299.99 pr
MN1149	1966-72	sm block & B/RB	219.99 pr
MN1150	1971	426 Hemi	299.99 pr
MN1933*	1973-75	273/318	179.99 pr
MN1934*	1973-75	340/360	179.99 pr
MN1935*	1973-75	B/RB	179.99 pr

E-Body

MN1149	1970-74	sm block & B/RB	219.99 pr
MN1150	1970-71	426 Hemi	299.99 pr



MN1936

MN1937

1962-74 Torque Strap

Throw away your chains and broken motor mounts: this torque strap can handle all the upgraded power and excess vibration your Mopar small block or B/RB engine can dish out. Features heavy duty rod ends for adjustability, urethane bushings, DOM tubing and grade 8 hardware. Does not interfere with power steering and does not require welding or major fabrication. Includes powder coated torque strap, all necessary hardware and instructions. Mounts in existing sway bar location on some models. Made in the USA.

MN1936	1963-66	A-Body	102.99 set
MN1937	1967-74	A-Body	102.99 set
MN1938	1962-65	B-Body	102.99 set
MN1939	1966-72	B-Body	102.99 set
MN1939	1970-74	E-Body	102.99 set



MN2154

Motor Mount Hardware

This hardware installs directly in the center of the motor mount brackets to attach them to the frame mount. Made from steel as original.

MN2154	bolt, V8	29.99 pr
MN2155	nut, V8	5.99 pr



Engine Support Bracket Bolt Set

These factory style bolts attach your engine support brackets to the motor mount ears on the side of your engine block. Made from high strength steel, this set features correct thin style washers and fine thread bolts as original. Perfect for high horsepower applications. One set contains six bolt/washer/nut assemblies, enough for both sides of the engine.

MN2415	all, 6 piece set	21.99 set
--------	------------------	-----------

ENERGY SUSPENSION



51106G

51106R

1973-76 Polyurethane Motor Mount Insert Set

This performance motor mount is firm enough to handle high horsepower and torque output, yet is soft enough to dampen excess vibration. Will not deteriorate when exposed to underhood fluids. This set replaces right and left side motor bushings. Available in red or black polyurethane. Made in USA.

Note: Must reuse the existing bushing outer metal shells.

Add "G" to part number for black, "R" for red.

A-Body

51106	1973	Dart 318, 340	35.99 set
51106	1973-76	Dart 360	35.99 set
51106	1973-75	Duster 318, 340	35.99 set
51106	1973-76	Duster 360	35.99 set
51106	1973-75	Valiant 318, 340	35.99 set
51106	1973-76	Valiant 360	35.99 set

B-Body

51106	1973-74	all 318, 400, 440	35.99 set
-------	---------	-------------------	-----------



1973-76 Prothane Motor Mount Insert Set

Polyurethane engine mounts limit unwanted movement and control torque to transfer maximum energy to the wheels. Polyurethane mounts are very durable and resistant to oil, chemicals, and road contaminants that deteriorate rubber mounts. Gain performance for the street or track with these nearly indestructible mounts. Made in USA.

A-Body

MN2710	1973	Dart 318, 340	44.99 set
MN2710	1973-76	Dart 360	44.99 set
MN2710	1973-75	Duster, 318, 340	44.99 set
MN2710	1973-76	Duster 360	44.99 set
MN2710	1973-75	Valiant 318, 340	44.99 set
MN2710	1973-76	Valiant 360	44.99 set

B-Body

MN2710	1973-74	all 318, 400, 440	44.99 set
--------	---------	-------------------	-----------



1973-76 Motor & Trans Mount Insert

These polyurethane transmission and motor mount inserts are engineered for your specific application to provide the performance of solid mounts without the vibration and noise. Polyurethane stands up to the elements better than rubber while limiting unwanted movement and controlling torque so that all possible energy is transferred to the wheels. Wheel hop is reduced, along with potentially damaging drive train movement.

Note: Will not work on 1973 340 models.

MN2711	1973-76	A & B-Body	81.99 set
--------	---------	------------	-----------

Specialty Engine Tools



PROFORM

66963

Universal Dial Indicators

These dial indicators are great for any engine builder. Both indicators are .001" graduation.

66963	0 to 0.250".....	25.99 ea
66962	0 to 1.000".....	25.99 ea



PROFORM

66787



66791

Degree Wheels

Find top dead center or check camshaft timing with these degree wheels.

66787	degree wheel kit.....	109.99 set
66791	9° degree wheel.....	19.99 ea



GEARWRENCH

HD Piston Ring Compressor

Use this tool to install pistons 2-1/8" to 5" (54 mm to 127 mm) in diameter. Positive lock action provides positive compression and fingertip release. Slip top over piston and tighten with L shaped wrench to compress piston ring into piston grooves. Insert piston into cylinder and tap with hammer to install. Enlarged crimped edge prevents compressor from entering cylinder.

X2284	10.99 ea
-------	-------	----------



PROFORM

Harmonic Balancer Tool

This heavy-duty, professional harmonic balancer tool is equipped with roller thrust bearings and includes 7/16"-20, 5/8"-18, and 3/4"-16 adapters as well as various removal hardware. May also be used for steering wheel and pulley installation and removal. Maximum recommended torque is 150 ft. lbs.

66514	71.99 set
-------	-------	-----------



PROFORM

Crankshaft Turning Sockets

Professional grade crankshaft turning socket is for the serious engine builder and tuner. Easily attach an oversized degree wheel to the socket.

67493	8 cylinder.....	31.99 ea
-------	-----------------	----------



GEARWRENCH

Oil Pressure Switch Socket

Removes oil pressure sending unit on most engines. The 3/8" drive socket has 1-1/16" hex opening plus recess to accommodate switch. Also fits some brake light switches. Can also be turned with 15/16" wrench.

X3923	5.99 ea
-------	-------	---------



GEARWRENCH

Harmonic Balancer Puller

This tool bolts to balancers, pulleys, and gears with tapped holes with the center screw on the end of the crankshaft. Tighten while tapping on the screw head to remove. A floating swivel prevents damage to the shaft end. Designed to accommodate two or three hole applications in most cars.

X2286	21.99 ea
-------	-------	----------



GEARWRENCH

Mechanic's Stethoscope

Locates the source of engine noise quickly. Listen for trouble by tracing the sound of flowing water, oil, gas or steam. Identify piston slap, worn gears, faulty valves, water pump failure, damaged gaskets and defective bearings. The handle is completely shock resistant. Disassembles for storage.

Note: Keep this tool away from moving, rotating and electrical components.

X835	18.99 ea
------	-------	----------



GEARWRENCH

X2953

X2956

X2957

Beam Type Torque Wrenches

Directly measure a variety of torque values when tightening fasteners. Pointer moves clockwise or counterclockwise to measure torque in English and metric. Satin finish scale reduces glare. Inset pound models feature ball type handles which localize force, assuring accuracy. Foot pound version has comfortable, palm-fit handle to provide natural smooth, accurate pull. Palm-fit handle pivots on beam to maintain constant distance from drive point to load point for precise measurement. Wrench can be easily calibrated by bending pointer to zero before use. Serviceable product. Non-ratchet.

X2955	1/4" fixed, inch/lbs.....	54.99 ea
X2956	3/8" fixed, inch/lbs.....	71.99 ea
X2957	1/2" fixed, foot/lbs.....	65.99 ea



Remote Starting Switch

Start the engine easily from under the hood! Features heavy gauge, rubber covered copper wire. Simply depress the button to jog or start the engine.

Y20750	19.99 ea
--------	-------	----------

Specialty Engine Tools



Y16910

Y16750

Valve Spring Compressor

Makes compressing the spring and removing the keepers a simple job because there is no need to remove the head. Faster than conventional compressors because there is no need to readjust the tool after each spring.

Note: When space prohibits use of cam handle, replace the handle with a bolt and turn the socket.

Y16750 compressor 41.99 ea
Y16910 bolt 1.99 ea



Top Dead Center Locator

66792 14mm threads 9.99 ea



66778

Valve Lash Wrench Sets

Choose from a variety of different wrench sets for valve lash adjustments. See below for availability.

66779 7/16" wrench, with 1/8" hex..... 24.99 set
66778 1/2" wrench, with 3/16" hex..... 24.99 set
With 3/16" & 7/32" Hex T-Handles
66780 9/16" wrench 24.99 set
66781 5/8" wrench 24.99 set



Flywheel Turner

This tool hooks into the flywheel teeth to rotate the crankshaft. Use when working on clutches, transmissions, installing rings, or other jobs which require the crankshaft to be in a specific position. Spring tension aids tool engagement on the flywheel.

X2270 30.99 ea



Swivoil Filter Wrench

Hard to reach oil filters will come off easily with this swivel handle oil filter wrench. Swivel tension is adjusted easily using the nut and bolt on the handle.

X3082 3-1/2" to 3-7/8" 9.99 ea



MNI084

MNI084 detail

1960-76 Mopar Oil Pump Priming Shaft

Service replacement oil pump priming shaft for 1960-76 Mopar models. This hardened steel shaft is used to prime the oil pump on all 1960-76 Mopar engines.

MNI084 11.99 ea



Make Engine Swaps a Breeze with the Engine Tilter

The Engine Tilter works with standard engine hoists to provide an additional axis to maneuver-adjust the angle of the engine with a turn of the handle! The Engine Tilter is rated for 1200 pounds, made from steel, weighs only 14 pounds, and comes fully assembled. Includes an upper lap link and four 20" chains. Made in USA.

MN2087 149.99 ea



Super Silicone Sealant

Excellent for use with all types of gaskets. A rapid curing adhesive/sealant can also be used as a sealant between flanges, hose connectors, and similar close fitting parts.

08661 clear, 3 oz. tube 9.99 ea
08662 black, 3 oz. tube 9.99 ea



Permatex® Gasket Maker

Makes reliable formed in place gaskets that resist cracking, shrinking and migrating. Coats pre-cut gaskets to increase reliability. Resists auto and shop fluids. Great for use on valve covers, intake manifold end seals, timing covers, water pumps, and thermostat housings. 3 oz. tube.

S80022 blue #6B 3.99 ea

S81166 red #26B 4.99 ea

S81878 copper #101B 5.99 ea



Form-A-Gasket Sealant

Slow drying, non-hardening sealant designed for sealing cut gaskets and stamped parts. Allows for easy disassembly if required. Temperature range of -65°F to 400°F. Use where sealing is more important than adhesion. Resists shop fluids and fuels. Great for valve cover gaskets and oil pan gaskets. Comes in 3 oz. tube in your choice of standard or hi-temp formula.

S80016 3 oz 3.99 ea

Royal Purple Max Tuff Assembly Lube

Max-Tuff is an ultra-tough, synthetic lubricant designed for use in reassembling repaired equipment. Max-Tuff utilizes durable synthetic molecules that adhere to metal surfaces and create an extremely strong barrier between surfaces. This minimizes the possibility of metal-to-metal contact while providing excellent protection against rust and corrosion to both ferrous and nonferrous metals. Max-Tuff is formulated with Royal Purple's proprietary Synslide additive technology.

RP01335 8 oz. bottle 19.99 ea

RP12335 case of 12 - 8 oz. bottles 215.99 ea

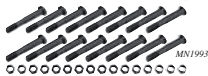

MNI1993

Rod Bolts and Hardware

Mopar Performance replacement rod nut and bolt sets (16 of each), for V8 engines. Grade 8 bolts for use with stock rods. 3/8" diameter bolts for 1967 and later small blocks and 7/16" diameter bolts for 1966-71 Street Hemis.

MNI1993 3/8" 99.99 set

MNI1994 7/16" 139.99 set

Specialty Engine Tools

New!



Compression Tester

Compression tester detects worn rings, burnt valves and blown head gaskets. Features external pressure release valve, full 2-1/2" easy-to-read face. U.S. and metric scales. 14" high pressure flexible oil and grease resistant hose. 14mm and 18mm ends fit most spark plug openings

Note: No further discounts apply.

AC7826 tester only 21.99 ea

New!



Professional Compression Tester

This compression tester is compatible with all standard spark plug threads. A quick disconnect coupler separates the hose from the gauge for easy connection to while a push-button side release valve allows repeated testing without disconnecting. Includes adapters for all standard spark plug threads, a repair kit with valves and rubber O-rings.

Note: No further discounts apply.

AC7828 39.99 ea

New!



Professional Fuel Pressure Tester

Use this professional fuel pressure tester to diagnose drivability problems caused by poor fuel pressure. Features a 40-inch hose, 2-1/2" gauge face with 0-100 psi/0-700 kPa scales, and a pressure relief button and 6-ft hose for safe gasoline disposal of gasoline and repeat tests. Includes test adapters for GM/Chrysler, GM TBI, M12 x 1.25 banjo bolt, and dual Manifold Test Adapter, as well as a handy storage pouch and a manual with step-by-step test procedures

AC7838 51.99 ea

New!



Remote Starter Switch

Start and crank engine from under the hood or from either side of the vehicle. Ideal for compression test or bumping engine onto TDC (top dead center) timing marks for valve, distributor or camshaft adjustment. Heavy-duty push button switch, 5-foot heavy-duty leads, 12 gauge conductors. 20-Amp, high current clips open to an extra wide 5/8" for easy hook-up. Made in USA.

Note: No further discounts apply

AC7854 34.99 ea

New!



Remote Starter Switch

Allows one person to start or crank the engine from under the hood. Ideal for compression test or bumping engine onto TDC (top dead center) timing marks for valve, distributor or camshaft adjustment. Power tool type trigger switch for regular use with medium currents. Heavy duty Neoprene leads. 10-Amp, medium current clips open to 1/2". Protective rubber boots prevent electrical shorts. Ergonomic handle. One year warranty. Made in USA.

Note: No further discounts apply

AC7853 9.99 ea

New!



AC7528



AC7529

Actron Advance Timing Light

This Advance Timing Light features an all metal inductive pickup, bright Xenon flash, and one-touch control. Available with a degree dialed knob for easy timing adjustments or digitally-controlled with LED display and tachometer functions. Detailed instructions included.

Note: No further discounts apply.

AC7528 adjustable knob 69.99 ea
AC7529 LED display 94.99 ea

New!



AC Delco 6V Inspection Camera

Thanks to advanced digital imaging technology, you can now see areas that were out of view and unreachable with inspection mirrors. Features a 3" high-resolution color LCD display and small 8mm (0.32") camera head. The camera features a two-setting 180° view flip, 12-setting adjustable zoom (up to 250%), and 5-setting LED brightness control, and a video-out port for viewing on full size monitors. The waterproof camera head and flexible allows you to explore virtually any environment.

Important: Requires 4 AA batteries (not included).

AC10011 147.99 ea



TD700101



TD700102

- **Inch Thread Identifiers contain nut and bolt sizes:**
8-32, 8-32, 10-24, 10-32, 1/4-20, 1/4-28, 5/16-18, 5/16-24, 3/8-16, 3/8-24, 7/16-14, 7/16-20, 1/2-13, 1/2-20.
- **Metric Thread Identifiers contain nut and bolt sizes:**
M4x0.7, M5x0.8, M6x1.0, M8x1.0, M8x1.25, M10x1.0, M10x1.25, M10x1.50, M12x1.25, M12x1.5, M12x1.75.

Thread Detective

This precise, easy-to-use thread identification tool is well suited for distinguishing between similar inch and metric threads on both nuts and bolts. Available in a heavy duty plastic box or attached to a wire lanyard. Comes with both metric and inch nut and bolt sizes (listed below).

TD700101 set in plastic box 49.99 set
TD700102 set on wire lanyard 34.99 set

Specialty Engine Tools

New!

actron



- Measures AC/DC voltage, DC current and resistance
- Backlit LCD is easy to read day or night
- Automatic polarity sensing avoids reversed test lead hook-up
- Automatic zero adjustment for volts, amps and battery tests for accurate measurements
- Detachable test leads
- Alligator clips included
- Comprehensive user manual with illustrated examples in English, Spanish, and French

Digital Multimeter

This AutoAnalyzer performs all standard electrical tests for on-car and bench troubleshooting. Locate faulty wiring, test electrical components, engine sensors, ignition and fuel systems and starting/charging system voltage. Pinpoint problem area and determine which components need repair or replacement.

Note: No further discounts apply
AC7665 \$1.99 ea

actron



- Tests engine RPM and dwell
- Measures AC/DC voltage, DC current and resistance
- Tests diodes and continuity
- Automatic reverse polarity indication
- Automatic zero adjustment for volts and amps for accurate measurements
- Overload protection on all ranges

Multimeter & Engine Analyzer

This tool performs all standard electrical tests for on-car and bench troubleshooting. Locate faulty wiring, test electrical components, engine sensors, ignition and fuel systems and starting/charging system voltage. Pinpoint problem area and determine which components need repair or replacement.

Note: No further discounts apply.
AC7677 \$4.99 ea

New!

actron

Elite Autoscaner Pro

This OBD I and OBD II enhanced scan tool offers hobbyists and technicians the features they need. Upgraded features include the ability to read domestic enhanced codes, graph engine data, record stored vehicle information, and the ability to print information through a PC. Compatible with ALL 1996 and newer OBD II compliant vehicles as well as certain pre-1996 GM, Ford and Chrysler vehicles. All Actron code readers and scan tools are CAN compliant.

Note: No further discounts apply

- Read and erase generic and manufacturer-specific Diagnostic Trouble Codes (DTCs)
- Displays and resets MIL (Malfunction Indicator Lamp) status
- Read, record & playback live sensor data
- OBD II emissions check and drive cycle mode
- Read and display I/M (Inspection/Maintenance) monitors
- Battery powered for off-vehicle data review
- Large, backlit LCD
- USB port allows updates via internet
- Print data via PC
- Trilingual menu & options - English, French, Spanish

AC9190 \$34.99 ea

OBD II PocketScan Plus New!

PocketScan® Plus is the most advanced, powerful and compact code reader available! Besides reading DTCs, this scan tool provides freeze frame data, VIN info and performs I/M Inspection maintenance-readiness testing. An excellent resource before and after repairs are made!

Note: No further discounts apply.

- Automatically reads Diagnostic Trouble Codes (DTCs) when connected
- Displays over 4,000 OBDII generic code definitions
- Compatible with ALL 1996 and newer vehicles (OBD II & CAN)

AC9550 \$79.99 ea

New!

actron



- Read and erase Diagnostic Trouble Codes (DTCs)
- Displays and resets MIL (Malfunction Indicator Lamp) status
- Read, record & playback live sensor data
- OBD II emissions check and drive cycle mode
- Read and display I/M (Inspection/Maintenance) monitors
- ABS code read/erase capability for most 1996 and newer GM, Ford, and Chrysler vehicles
- Large, backlit LCD
- USB port allows updates via internet
- Print data via PC
- Trilingual manual (English, Spanish, and French)

OBD II / ABS AutoScanner

This OBD II scanner not only displays the diagnostic trouble codes, but also can help troubleshoot the problem with the most probable solutions specific to the vehicle's make, model, year, and engine. The AutoScanner Plus indicates which codes have troubleshooting details available. It's a simple push of the button to access the CodeConnect database of 3 million verified fixes. Compatible with OBD II and CAN vehicles 1996 and newer.

Important: Troubleshooting data in English only.
Note: No further discounts apply.
AC9580 \$209.99 ea

New!

actron



Infrared Thermometer

Aim this IR thermometer at the target, press a button, and read the temperature display. Verify the temperature in your AC system or find an overcharge in your electrical system. System-On-Chip technology creates a compact, lightweight design with a measurement range of -58°F to +932°F (-50°C to +500°C). Includes two AAA batteries and belt holster.

Note: No further discounts apply.
AC7876 \$59.99 ea

New!

MSD



MSD Self-Powered Timing Light

This self-powered timing light is a tool every tuner should have. Because it does not require 12 volts, less wires are hung over the engine, making for quick, easy checks. For power, the light uses six AAA batteries. The lightweight assembly is injection molded for durability and produces an intense strobe that is easy to view through 5,000 rpm. The inductive pick-up is detachable for easy storage.

8991 \$224.99 ea

New!

MSD



MSD Timing Light

This MSD Timing Pro is constructed with solid state circuitry and uses a Silicon Controlled Rectifier (SCR) to provides accurate and stable timing signals from 0 to 8,000 rpm. This rugged timing light is built to work in rough environments such as racing pits or professional mechanic shops. The lightweight, durable assembly produces an intense strobe that is easy to view even in daylight. The inductive pickup is detachable for easy storage and for safety measures while the battery clamps provide a strong grip to the terminals. The battery clamps are color-coded and insulated for tight, safe connections.

8990 \$167.99 ea

New!



Rocker Stud Remover & Tap Alignment Tool

Make removing the rocker studs easier by using this special tool designed for not only removing rocker studs, but aligning as well.

66783 \$19.99 ea

March Performance Pulleys

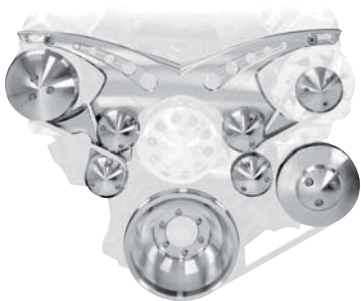

black onyx
powder coat finish



black
powder coat finish



chrome finish



clear
powder coat finish



March "Revolver" Serpentine Sets

This highly styled one piece bracket, designed especially for Big Block Mopar models and Hemi is CNC machined from 6061-T6 aluminum for strength and perfect fit. Provides a rigid backbone for the alternator and A/C compressor, while a separate bracket allows the addition of a power steering pump, if desired. Four

separate idlers guarantee no-slip operation. Hard coated on high wear areas and clear powder coated to eliminate polishing in hard to reach places. Made in USA.
Note: No further discounts apply.

- 105 Amp Alternator; Chrome
- Alternator Pulley w/Fan & Nose Cover
- Matching Chrome AC compressor
- AC Compressor Nose Cover
- Polished Aluminum Water pump
- Hard coated Water Pump Pulley
- Alternator/AC Bracket
- Crank Hub Adapter
- Larger Diameter Crankshaft Pulley
- Belt Tensioning Tool
- Power Steering Pulley Nose Cover
- Mounting Hardware
- Kits with Power Steering Include GM Type 2 Power Steering Pump (Hoses & Reservoir Not Included)
- Chrome or Billet Canister Style Power Steering Pump (where listed)
- Power Steering Pulley w/Nose Cover
- Idlers
- Bracket with mounting hardware

383, 440 & 426 Hemi Revolver Serpentine Sets

Alternator and AC Only

Note: Revolver Sets without power steering are for 71.5" serpentine belts.

MN2648	clear powder coat	2069.99	set
MN2685	chrome	2785.99	set
MN2689	black onyx powder coat	2269.99	set
MN2652	black powder coat	2269.99	set

Remote Power Steering Pump and AC

Note: Revolver Sets with Remote Power Steering and AC are for 81.5" serpentine belts.

MN2649	clear powder coat	2359.99	set
MN2686	chrome	3119.99	set
MN2690	black onyx powder coat	2559.99	set
MN2653	black powder coat	2559.99	set

Chrome Alternator and Canister style PS Pump

Note: Revolver Sets with chrome alternator and chrome power steering pumps are for 67.5" serpentine belts.

MN2650	clear powder coat	1679.99	set
MN2687	chrome	2329.99	set
MN2691	black onyx powder coat	2009.99	set
MN2654	black powder coat	2009.99	set

Billet Alternator and Billet Canister style P/S Pump

Note: Revolver Sets without billet alternator and billet power steering pumps are for 67.5" serpentine belts.

MN2651	clear powder coat	1949.99	set
MN2688	chrome	2649.99	set
MN2692	black onyx powder coat	2139.99	set
MN2636	black powder coat	2139.99	set

Chrysler 5.7 Hemi Revolver Serpentine Sets

Alternator and AC Only

Note: Revolver Sets without power steering are for 71.5" serpentine belts.

MN2634	clear powder coat	1859.99	set
MN2693	chrome	2545.99	set
MN2695	black onyx powder coat	2049.99	set
MN2636	black powder coat	2049.99	set

Alternator, AC and P/S Pump

Note: Revolver Sets with AC and power steering pumps are for 80.5" serpentine belts.

MN2635	clear powder coat	2199.99	set
MN2694	chrome	2885.99	set
MN2696	black onyx powder coat	2359.99	set
MN2637	black powder coat	2359.99	set

March Performance Pulleys



clear powder coat finish



black powder coat finish



Made in USA

Serpentine Belt Ultra Sets

This stylish serpentine conversion set solves the problem of unreliable V-belt accessory drives for Chrysler 383ci, 440ci and Hemi. No more belt throwing or slipping. A unique combination bracket mounts the alternator and A/C in a compact manner. The power steering bracket accepts a standard Saginaw pump. Three idlers guarantee plenty of belt wrap for no-slip operation. Precision CNC machined from 6061-T6 aluminum for strength and perfect fit. Hard coated on high wear areas and clear coated to eliminate polishing in hard-to-reach places. Made in USA.

Note: Serpentine belts are not included in any of the sets, however the belt length is included below. No further discounts apply.

- Combination Alternator/AC bracket and Rear Support
- Power Steering Bracket, & Support
- Power Steering Pulley with cover
- Crank pulley, Water Pump pulley and Nose Cover
- Alternator Pulley with Cover
- Belt Tensioning Rod
- Idlers and Covers
- Grade 8 mounting hardware
- AC Compressor Cover

Ultra Sets

Note: will not work with billet alternator, also requires a electric fuel pump.

Alternator, A/C and Canister Style keyway P/S - 82" Serpentine Belt for 383	
MN2590 clear powder coat.....	1129.99 set
MN2596 black powder coat.....	1329.99 set
Alternator, A/C and Canister Style keyway P/S - 82" Serpentine Belt for 440	
MN2592 clear powder coat.....	1129.99 set
MN2598 black powder coat.....	1329.99 set
Alternator, A/C and Canister Style keyway P/S - 83.5" Serpentine Belt for Hemi	
MN2594 clear powder coat.....	1129.99 set
MN2600 black powder coat.....	1329.99 set
Alternator, A/C and Canister Style press fit P/S - 82" Serpentine Belt for 383	
MN2591 clear powder coat.....	1129.99 set
MN2597 black powder coat.....	1329.99 set
Alternator, A/C and Canister Style press fit P/S - 82" Serpentine Belt for 440	
MN2593 clear powder coat.....	1129.99 set
MN2599 black powder coat.....	1329.99 set
Alternator, A/C and Canister Style press fit P/S - 83.5" Serpentine Belt for Hemi	
MN2595 clear powder coat.....	1129.99 set
MN2601 black powder coat.....	1329.99 set

Serpentine Belt Deluxe Sets

This deluxe serpentine conversion set for Chrysler small block and big block engines helps eliminate the belt throwing or slipping that you get from V-belt accessory drives. Precision CNC machined from 6061-T6 aluminum for strength and perfect fit. Hard coated on high wear areas and clear coated to eliminate polishing in hard-to-reach places. The power steering bracket accepts a standard Saginaw pump. Made in USA.

Note: Serpentine belts are not included in any of the sets, however the belt length is included below. No further discounts apply.

- Alternator bracket and tensioning rod
- Crank pulley, water pump pulley and nose cover
- Alternator pulley with nose cover
- Power steering kit includes bracket, tensioning rod & pulley w/cover
- Air conditioning kit includes AC bracket, tensioner and AC nose cover

Small Block Deluxe Sets

Alternator Only - 45" Serpentine Belt for 1970-76 318, 340 and 360	
MN2602 clear powder coat.....	369.99 set
MN2608 black powder coat.....	575.99 set
Alternator and A/C - 45" Serpentine Belt for 1970-76 318, 340 and 360	
MN2605 clear powder coat.....	859.99 set
MN2611 black powder coat.....	1059.99 set
Alternator and Canister Style keyway P/S - 45" Serpentine Belt for 1970-76 318, 340 and 360	
MN2603 clear powder coat.....	589.99 set
MN2609 black powder coat.....	809.99 set
Alternator and Canister Style press fit P/S - 45" Serpentine Belt for 1970-76 318, 340 and 360	
MN2604 clear powder coat.....	619.99 set
MN2610 black powder coat.....	829.99 set
Alternator, A/C and Canister Style keyway P/S - 45" Serpentine Belt	
MN2606 clear powder coat.....	859.99 set
MN2612 black powder coat.....	1099.99 set
Alternator, A/C and Canister Style press fit P/S - 45" Serpentine Belt	
MN2607 clear powder coat.....	859.99 set
MN2613 black powder coat.....	1059.99 set

Big Block Deluxe Sets

Alternator Only - 42.5" Serpentine Belt for 383 and 400	
MN2614 clear powder coat.....	384.99 set
MN2624 black powder coat.....	575.99 set
Alternator and Canister Style keyway P/S - 42.5" Serpentine Belt for 383 and 400	
MN2615 clear powder coat.....	619.99 set
MN2625 black powder coat.....	809.99 set
Alternator and Canister Style press fit P/S - 42.5" Serpentine Belt for 383 and 400	
MN2616 clear powder coat.....	619.99 set
MN2626 black powder coat.....	829.99 set
Alternator, A/C and Canister Style keyway P/S - 42.5" Serpentine Belt for 383 and 400	
MN2617 clear powder coat.....	869.99 set
MN2627 black powder coat.....	1109.99 set
Alternator, A/C and Canister Style press fit P/S - 42.5" Serpentine Belt for 383 and 400	
MN2618 clear powder coat.....	869.99 set
MN2628 black powder coat.....	1109.99 set
Alternator Only - 43.6" Serpentine Belt for 426, 440 and Crate Hemi	
MN2619 clear powder coat.....	384.99 set
MN2629 black powder coat.....	575.99 set
Alternator and Canister Style keyway P/S - 43.6" Serpentine Belt for 426, 440 and Crate Hemi	
MN2620 clear powder coat.....	589.99 set
MN2630 black powder coat.....	809.99 set
Alternator and Canister Style press fit P/S - 43.6" Serpentine Belt for 426, 440 and Crate Hemi	
MN2621 clear powder coat.....	619.99 set
MN2631 black powder coat.....	809.99 set
Alternator, A/C and Canister Style keyway P/S - 43.6" Serpentine Belt for 426, 440 and Crate Hemi	
MN2622 clear powder coat.....	869.99 set
MN2632 black powder coat.....	1069.99 set
Alternator, A/C and Canister Style press fit P/S - 43.6" Serpentine Belt for 426, 440 and Crate Hemi	
MN2623 clear powder coat.....	869.99 set
MN2633 black powder coat.....	1109.99 set

Aftermarket Pulley Systems



black onyx
powder coat finish
black
powder coat finish
chrome finish
clear
powder coat finish

March "Style-Track" Serpentine Systems

Enjoy high style, low cost excitement for your Chrysler Small Block V8. This set includes a one-piece alternator and air conditioning bracket for rigid support, while a separate bracket allows the addition of a power steering pump, if desired. Four separate idlers guarantee no-slip operation, while maintenance-free powder coating in your choice of Clear, Black, or Black Onyx lets you forget about polishing. Made in USA.

Note: Serpentine belt is not included with any set, however length of belt is listed below and included in the instructions. No further discounts apply.

- 105 Amp Alternator Chrome
- Alternator Pulley with Fan & Nose Cover
- Chrome AC Compressor
- Water Pump & Hardcoated Pulley
- Alternator and P/S Bracket
- Crankshaft Pulley
- Belt Tensioning Tool
- Mounting Hardware
- Power Steering Bracket
- 4 Idlers (for better belt wrap)
- GM Type 2 Power Steering Pump (Hoses & Reservoir Not Included)



318, 340 & 360 Style-Track Serpentine Sets

Alternator and AC Only

Serpentine Sets for 69" Belts			
MN2638	clear powder coat	1989.99	set
MN2697	chrome	2649.99	set
MN2702	black onyx powder coat	2139.99	set
MN2643	black powder coat	2139.99	set

Remote Power Steering Pump and AC

MN2639	clear powder coat	2229.99	set
MN2703	chrome	2879.99	set
MN2703	black onyx powder coat	2429.99	set
MN2644	black powder coat	2429.99	set

Canister Style Power Steering - 81.5" Belt

MN2640	clear powder coat	2379.99	set
MN2699	chrome	3029.99	set
MN2704	black onyx powder coat	2574.99	set
MN2645	black powder coat	2574.99	set

Chrome Alternator and Canister style P/S Pump

Chrome Alternator and Chrome Canister Type Power Steering Pumps			
MN2641	clear powder coat	1669.99	set
MN2700	chrome	2309.99	set
MN2705	black onyx powder coat	1959.99	set
MN2646	black powder coat	1959.99	set

Billet Alternator and Canister style P/S Pump

Billet Alternator and Billet Canister Type Power Steering Pumps			
MN2642	clear powder coat	1859.99	set
MN2701	chrome	2545.99	set
MN2706	black onyx powder coat	2195.99	set
MN2647	black powder coat	2195.99	set



MN2659



MN2660



MN2661



MN2662



MN2663



MN2664



MN2665



MN2666

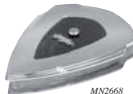

MN2668



MN2656



MN2658



Accessories for March Performance Pulley Systems

Billet valve cover emblems and air cleaners for March Performance pulley systems. Complement the style of your engine's pulley system with these accessories. Fits 5-1/8" standard carburetor necks. Made in USA.

Note: No further discounts apply.



Billet Aluminum Air Cleaners

MN2659	Grande Style Track, chrome finish	879.99	ea
MN2660	Grande Revolver, chrome finish	879.99	ea
MN2661	Grande Revolver, black onyx finish	879.99	ea
MN2662	Style Track, chrome finish	909.99	ea
MN2663	Revolver, chrome finish	849.99	ea
MN2664	Pro Track, chrome finish	889.99	ea
MN2665	Pro Track, black onyx finish	889.99	ea
MN2666	Pro Track Fuelie, chrome finish	1299.99	ea
MN2667	Futura, clear powder coat finish	469.99	ea
MN2668	Futura, chrome finish	619.99	ea

Billet Aluminum Valve Cover Emblems

MN2656	Futura emblem with carbon fiber insert	319.99	pr
MN2657	Circle Track emblem	269.99	pr
MN2658	Revolver emblem	269.99	pr

Crank & Accessory Pulleys



Crankshaft Pulley Bolt Set

This special steel bolt set is used to attach the crankshaft pulley to the damper. Made from steel.

MN2412 all engines set of 6..... 11.99 set

BOUCHILLON
PERFORMANCE
EXPOSURE



MD2369



MD2370



MD2371



MD2374

Bouchillon Performance Crankshaft Pulleys

Can't find the correct pulleys to complete your vehicle? We have the solution. Original style pulleys are available for all popular applications, including all big block combinations, with or without power steering or air conditioning. Also available for small block, with aluminum water pump and with or without power steering. Power steering pulleys are for Saginaw pumps on B, RB and Hemi engines. Available in your choice of black or chrome.

Crankshaft Pulley

MD2369	single groove	all	A/B/RB/Hemi	black	54.99	ea
MD2370	single groove	all	A/B/RB/Hemi	chrome	64.99	ea
MD2371	double groove	w/PS	A/B/RB/Hemi	black	79.99	ea
MD2372	double groove	w/PS	A/B/RB/Hemi	chrome	89.99	ea
MD2373	four groove	w/PS & AC	B/RB/Hemi	black	159.99	ea
MD2374	four groove	w/PS & AC	B/RB/Hemi	chrome	164.99	ea

Warning Concerning Crankshaft Pulleys

Stock replacement, aftermarket stamped steel or cast iron pulleys are not designed to exceed 400 horsepower or 6000 RPM. Using reproduction pulleys on engines in excess of these limits may result in catastrophic disintegration of the pulley causing severe damage to the engine, cooling system and body parts. Classic Industries' assumes no liability for damages caused by improper usage of pulleys. Please be sure to install the pulley properly to avoid damages that could occur from improper installation or exceeding the recommended RPM limitations.

MARCH



MN2670

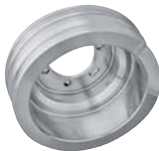

MN2677



Made in USA

March Performance V-Belt Pulley Sets

March Performance V-Belt pulleys can free up 12-15 horsepower at the rear wheels. These pulleys eliminate belt throwing and reduce accessory drag. They also increase water pump speed to improve cooling. Features a clear powder coat to eliminate polishing. Sets include crank pulley, water pump pulley, and alternator pulley with cover. Made in USA.

Important: *2 V-belt pulley replaces 1 V-belt pulley

Note: No further discounts apply.

DISCOUNTED
PRICES

Performance Ratio Pulley Sets

1967-69 273, 318 & 340	
MN2671	1V crank, 1V water pump, 1V alternator..... 249.99 set
MN2672	2V crank, 1V water pump, 1V alternator..... 249.99 set
1970-76 318, 340 & 360	
MN2669	1V crank, 1V water pump, 1V alternator..... 229.99 set
MN2670	2V crank, 1V water pump, 1V alternator..... 249.99 set
383, 440 and Crate Hemi	
MN2673	1V crank, 1V water pump, 1V alternator..... 229.99 set
MN2674*	2V crank, 2V water pump, 1V alternator..... 244.99 set

High Flow Ratio Pulley Sets

Small Block 318, 340 & 360	
MN2675	1V crank, 1V water pump, 1V alternator..... 239.99 set
MN2676	2V crank, 1V water pump, 1V alternator..... 254.99 set
MN2677	3V crank, 1V water pump, 1V alternator..... 249.99 set
Big Block 383, 440 & Crate Hemi	
MN2678	1V crank, 1V water pump, 1V alternator..... 249.99 set
MN2679*	2V crank, 2V water pump, 1V alternator..... 249.99 set
MN2680	4V crank, 1V water pump, 2V alternator..... 249.99 set

Performance Ratio for Fluidampr Balancers

Small Block 318, 340 & 360	
MN2681	1V crank, 1V water pump, 1V alternator..... 239.99 set
MN2682	2V crank, 1V water pump, 1V alternator..... 249.99 set
Big Block 383, 440 & Crate Hemi	
MN2683	1V crank, 1V water pump, 1V alternator..... 239.99 set
MN2684*	2V crank, 2V water pump, 1V alternator..... 249.99 set

Harmonic Balancers



MN1088



MN1995



MN1093



MN1143

1962-91 Harmonic Balancers & Crankshaft Keys

1962-70 Big Block Harmonic Balancer

Harmonic balancer for 1962-70 361-440 engines with forged crank. Balancer features a steel ring, universal 6-bolt front pulley mounting style and is SFI-approved.

MN1088 1962-70 361-440..... 499.99 ea

1966-71 426 Hemi Harmonic Balancer

Harmonic balancer for 1966-71 426 Hemi engines. Balancer features a steel ring, universal 6-bolt front pulley mounting style and is SFI-approved.

MN1089 1966-71 426 Hemi..... 499.99 ea

1967-91 Small Block Harmonic Balancer

Harmonic balancer for 1967-91 273-318-340 engines with forged crank. Balancer features a steel ring, universal 6-bolt front pulley mounting style and is SFI-approved.

MN1090 1967-91 273-318-340..... 499.99 ea

1967-76 273/318 Small Block Harmonic Balancer

Production-style thin crank vibration damper is designed for all production based small block engines. Not SFI-approved.

MN1092 1967-76 273-318-340..... 194.99 ea

1971-76 360 Small Block Harmonic Balancer

Externally-balanced balancer for 1971-76 360 "LA" Engines. Not SFI approved.

MN1995 1971-76 360..... 124.99 ea

1972-76 400 Big Block Harmonic Balancer

1972-76 400 cast crank engines. Steel ring style. SFI approved.

MN1996 1972-76 400..... 489.99 ea

Crank Key Set

Locates the crank sprocket on the nose of the crank. Includes 2 woodruff keys.

MN1093 all 2 piece set..... 6.99 set

Crankshaft "Oil Slinger"

Fits between the balancer and the front of the crankshaft on all V8 engines. Protects the engine in two ways - keeping excessive oil away from the crankshaft front seal and forces oil back onto the timing chain, keeping it properly lubricated under heavy usage.

MN1143 all engines..... 8.99 ea



Mopar Harmonic Balancer Bolt Sets

To ensure that the balancer stays locked in MD2385 n position, use ultra strong 200,000 psi bolts from ARP that let you exert maximum clamping force. Features 1/4" thick, wide-area washers and extra tall 12-point heads that accept deep sockets and prevent stripping the head. Made in USA.

AR1441 318-440 & 426 Hemi thin balancer..... 27.99 set
AR1442 318-440 thick damper..... 31.99 set
AR1443 5.7L & 6.1L Hemi..... 36.99 set

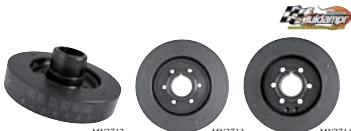

MN2712

MN2713

MN2714

Fluidampr Harmonic Balancers

These Fluidampr viscous dampers by Horschel Motorsports are among the best dampers on the market. Instead of a rubber, or "elastomer" dampening material that deteriorates over time, a silicone gel is used inside the damper to keep the flywheel in place and function as the insulator for the internal flywheel. This significantly reduces the risk of catastrophic failure that can occur when rubber dampers wear out. Measure 7-1/4" outer diameter, feature a steel construction, 1.5295" minimum and 1.5305 maximum bore diameter, and are finished in black zinc chromate. Made in the USA.

Note: *Minor modification may be necessary to the stock crank pulley.

MN2712* 318, 340, 360 A/LA V8..... 519.99 ea
MN2713 383, 426, 440 and 426 Hemi V8..... 505.99 ea
MN2714 331, 354, 392 early Hemi V8..... 449.99 ea



MN2724

MN2718

MN2719

Pro Race SFI-Approved Harmonic Balancers

Pro Race harmonic balancers are designed for a wide range of high performance applications. These performance dampers are direct replacements for cast iron factory originals and are SFI approved for racing. PRO/STREET balancers measure 7.25" in diameter and 1.00" in thickness. PRO/RACE balancers measure 7.01" in diameter and 1.54" in thickness. PRO/SPORT balancers measure 6.61" in diameter and 1.52" in thickness, while PRO/STREET Underdrive balancers measure 5.86" in diameter and 1.67" in thickness.

CAUTION: PRO/STREET or PRO/SPORT counterweights are not interchangeable with PRO/RACE counterweights.

Note: *Fits 426 Hemi engine with slight TDC adjustment detailed in instruction manual that is supplied. Will not fit early 354 & 392 Hemi engines.

Small Block Engines

PRO/STREET Bonded Nodular Iron Balancers
MN2715 273-360 V8 internally balanced..... 95.99 ea
MN2716 318-360 V8 externally balanced..... 99.99 ea

PRO/SPORT All-Steel Balancers
MN2722 273-360 V8 internally balanced..... 159.99 ea
MN2723 318-360 V8 externally balanced..... 169.99 ea

PRO/RACE All-Steel Balancers
MN2719 273-360 V8 internally balanced..... 339.99 ea
MN2720 318-360 V8 externally balanced..... 359.99 ea

Big Block Engines

PRO/STREET Balancers
MN2717* 383-440 V8 internally balanced..... 94.99 ea

PRO/SPORT Balancers
MN2724 383-440 V8 internally balanced..... 169.99 ea

PRO/RACE Balancers
MN2721* 383-440 V8 internally balanced..... 339.99 ea

New Hemi V8 Engines

PRO/SPORT Underdrive Balancers - 20% Reduction
MN2718 5.7 Hemi V8 internally balanced..... 249.99 ea

Engine Sealing Components

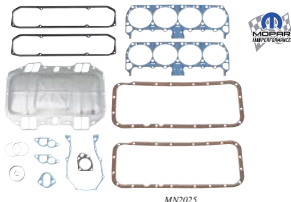

MN2025

1960-2003 Mopar Performance Engine Tear-down Gasket Sets

Mopar Performance engine tear-down gasket sets give you all the gaskets needed for minor engine teardown, including oil pan, cylinder heads, valve covers, timing chain cover, intake manifold and oil or fuel pump.

Note: These sets are intended for tear-down and reassembly. These are not complete sets designed for an engine rebuild.

Small Block Engines

MN2022	1971-91	340/360	139.99 set
MN2021	1992-03	318 Magnum	162.99 set
MN2023	1992-03	360 Magnum	159.99 set

Big Block Engines

MN2024	1960-76	383/400	169.99 set
MN2025	1960-76	426/440 Wedge	169.99 set

Hemi Engines

MN2026	1966-71	426 Hemi	129.99 set
--------	---------	----------	------------

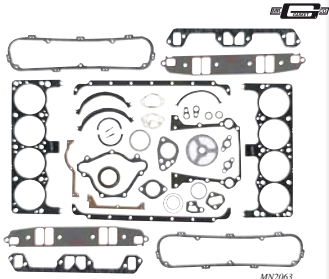

MN2063

1963-76 Mr. Gasket Ultra-Seal Engine Overhaul Gasket Sets

Ultra-Seal engine gasket sets are designed for high performance applications to provide maximum sealing of bi-metal (cast iron/aluminum cylinder head) engines. Includes Ultra-Seal cylinder head, intake, exhaust, valve cover and oil pan gaskets and standard timing cover, fuel pump, thermostat, water pump and rear main seals.

MN2063	1971-76	340, 360	184.99 set
MN2065	1963-76	361-440 exc. Hemi	139.99 set

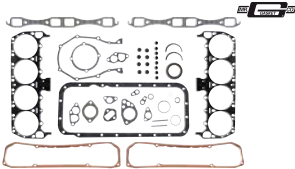

MN2064

1963-76 Mr. Gasket Standard Engine Overhaul Gasket Sets

These engine overhaul sets include all the gaskets and seals needed for stock, moderate performance engine rebuilds and meet or exceed OE gasket and seal specifications.

MN2060	1967-76	273, 318	84.99 set
MN2062	1971-76	340, 360	59.99 set
MN2064	1963-76	361-440 except Hemi	84.99 set



1967-76 Mr. Gasket Camshaft Change Gasket Set

Cam Change gasket sets give you all that is needed to change out your camshaft. This set includes valve cover, oil pan, fuel pump, water pump, intake manifold, timing cover gaskets and timing cover seal.

MN2056	1967-76	273, 318	39.99 set
MN2056	1971-76	340, 360	39.99 set



Engine Block Pipe Plug Set

This convenient set includes ten pipe plugs you will need for the entire outside of the engine. This set includes oil galley port plugs for the top rear of the block, fuel pump pushrod port plugs, water pump housing and heater hose port plugs, coolant drain plugs (below the freeze plugs), and intake vacuum port plug. Because various plug and thread sizes will be needed depending on the components used, this set includes multiple plugs to handle most applications.

Note: Four internal oil galley plugs will also be needed. These are included with the freeze plug kits.

MN2411	V8	14.99 set
--------	----	-----------

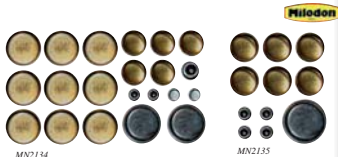

MN2134

MN2135

Milodon Brass Freeze Plug Sets

Your engine deserves the best, and Milodon brass freeze plugs will not rot like steel alternatives. Sets include all the necessary external block freeze plugs, camshaft and oil galley plugs for a complete engine.

MN2134	273-360	39.99 set
MN2135	383-440	19.99 set

Timing Components



1960-76 Performance Timing Chain Sets

High strength Mopar Performance double roller chain provides added durability and decreased rotational friction versus the production silent chain. Crank sprocket features three matched keyways to adjust cam timing. Set includes cast iron magna-fluxed sprockets and a roller timing chain.

373-360 Small Block	
MN2146 1964-76	84.99 set
383-440 Big Block	
MN2147 1960-76 1 bolt gear	119.99 set
MN2148 1966-71 3 bolt gear	116.99 set
426 Hemi	
MN2148 1966-71 3 bolt gear	116.99 set



MN2126



1960-76 High Energy Timing Chain Set

High Energy Timing Chain sets exceed all original equipment timing chain specifications. Premium quality link belt type timing chain for exceptional durability. Ideal for stock replacement and mild performance application. The camshaft and crank gear sprockets are made from cast iron.

Note: Features a single bolt gear and will not fit 426 Hemi or 440 Six Pack.

MN2126 1960-76 273-360 & 318A	31.99 set
MN2127* 1960-76 383-440	36.99 set



MN2128



Magnum Double Roller Timing Chain Set

Magnum Double Roller Timing chain sets are ideal for street or performance applications. They feature a 3 keyway crank sprocket for 4-degree incremental adjustability, 4-degree maximum advance/retard. The camshaft gear is made from induction hardened cast iron and the crank sprocket is billet steel. The chain is a heavy-duty pre-stretched heat-treated true double roller timing chain.

Note: MN2129 is made with a single bolt cam gear and will not fit 426 Hemi or 440 Six Pack. MN2130 has a 3 bolt cam gear design.

MN2128 1960-76 273-360 & 318A	45.99 set
MN2129 1960-76 383-440	49.99 set
MN2130 1960-73 383-440 B/RB	49.99 set
MN2130 1960-73 426 Hemi	49.99 set



MN2131



MN2133

Keyway Adjustable Billet Timing Chain Set

Keyway Adjustable Billet Timing Chain sets are ideal for all street performance and race applications. It includes a Torrington roller thrust bearing for reduced friction. Features a 9 keyway crank sprocket for 2-degree incremental adjust ability, 8-degree maximum advance/retard. The gears are induction hardened and precision machined steel billet gears for built proof durability. The chain is pre-stretched, heat treated double roller timing chain with heavy-duty large pin design.

Note: Choose from single or three bolt camshaft gears.

MN2131 273-360 single bolt cam	104.99 set
MN2132 383-440 single bolt cam	104.99 set
MN2133 383-440 three bolt cam	104.99 set
MN2133 426 Hemi three bolt cam	104.99 set



E7805



Edelbrock Performer-Link Timing Chain & Gear Set

Performer-Link timing chain & gear sets are for use with Edelbrock cams. They have a solid-bushing chain for a true bearing surface that rolls with the sprockets, eliminating chain stretch. Cam sprockets are made with 35,000 psi tensile strength cast iron, crank sprockets are made from billet SAE-1144 steel and induction heat treated. All timing chain sets have three keyway setting points to ensure accurate timing selection for early to late model vehicles. Performer-Link timing sets are not for use above 6500 rpm.

Important: Not legal for sale or use on pollution controlled motor vehicles. Note: No further discounts apply.

E7803 1956-90 small block	69.99 ea
E7804 1955-80 big block (1 bolt)	69.99 ea
E7805 1955-80 big block (3 bolt)	94.99 ea



3361S



1963-74 Melling Timing Chain Sets

Three piece timing set includes timing chain, cam sprocket and crankshaft sprocket.

3361S 1964-74 273, 318, 360	21.99 set
3168SA 1963-65 426 Wedge	89.99 set
3168S 1966-74 426 Hemi	84.99 set
3168S 1966-74 440 w/3 2BBL carbs	84.99 set
3160S 1968-73 340	39.99 set



Chrome Timing Chain Cover/Timing Tab

This beautiful chrome-plated (not Hemi) cover fits Chrysler 383, 400, 426 (including timing) and 440 engines.

T9392 big block and Hemi	12.99 ea
--------------------------	----------



1970-76 Mopar Timing Chain Cover Set

Mopar Performance timing cover made from cast aluminum fits all 1970 and later (318/340/360) small block engines. This cover has a natural finish that has the timing mark cast into it. Includes the seal and gasket.

Note: This cover will also fit 1967-69 273/318/340 engines but will have a different timing mark location than the originals.

MN2018 1970-76	89.99 ea
----------------	----------

Timing Components



1960-76 Chrome Timing Tab

Designed for use with chrome aftermarket timing cover. Fits all big block Chrysler engines including late 426 Hemi. Sold as a replacement only. Will not fit with the stock cover.

T9393 1960-76 big block and Hemi. 3.99 ea



1960-76 Mr. Gasket Timing Cover Seal

Mr. Gasket timing cover seals are a neoprene-rubber style that will last. Available for small block engines.

MN2059 1960-76 273-360..... 11.99 ea



MN2016

Camshaft Sprocket Attaching Hardware

Required when a fuel pump eccentric is used. The 273-360 LA engine sets include a bolt and a special washer. The B/R/B and Hemi engines are either 1 bolt or 3 bolt design requiring 1 to 3 bolts each.

MN2015 LA engines bolt w/washer..... 18.99 set
MN2016 B/R/B/Hemi 1 bolt design..... 3.39 ea
MN2017 B/R/B/Hemi 3 bolt design..... 14.99 ea



1969-92 Timing Chain Cover Bolt Set

Set of chrome timing chain cover bolts for 1969-92 small block engines. Includes 10 bolts per set.

MN2019 1969-92 small block..... 59.99 set



MN2020

1958-78 Timing Chain Cover Bolt Set

Complete set of chrome timing chain cover bolts for all B/R/B 1958-78 big block and 426 Hemi engines. Includes 8 bolts and 4 chrome washers per set.

MN2020 1958-78 big block..... 29.99 set

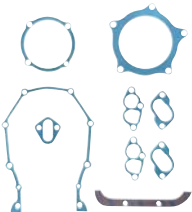

TCS124602

1964-74 Fel-Pro Timing Cover Gaskets

Correct replacement timing cover gaskets for Mopar V8 engines manufactured by Fel-Pro.

TCS565631 1964-74 273, 318..... 27.99 set
TCS565631 1964-74 340, 360..... 27.99 set
TCS124602 1964-74 383, 400..... 19.99 set
TCS124602 1964-74 413, 440..... 19.99 set
TCS124602 1964-74 426 Hemi/Wedge..... 19.99 set

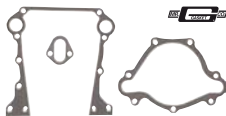

MN2057

Mr. Gasket Timing Cover Gasket Set

Mr. Gasket timing cover sets are made from a high-density cork/rubber blend material.

MN2057 1960-76 273, 318..... 14.99 set
MN2057 1960-76 340, 360..... 14.99 set
MN2058 1960-76 361-440..... 14.99 set



63241

Stainless Engine Bolt Kits

Perfect for the person who wants rust free engine hardware and are ideal for use when rebuilding or for detailing for a first class appearance.

Small Block Engines
63241 with metal valve covers..... 59.99 kit
Big Block Engines
63146 with cast valve covers..... 61.99 kit
63142 with metal valve covers..... 61.99 kit
Hemi Engines
63331 with cast valve covers..... 54.99 kit
6300 with metal valve covers..... 54.99 kit



MD2356

1964-74 Engine Fastener Kit

Buy one of these and get the correct engine fasteners in one kit. Each fastener kit is correct, from head markings to size and finish. If you want to do a first class job on your engine, try one of these kits. Each kit typically includes fasteners for the following: carburetor, choke, crank pulley, distributor hold down, intake & exhaust manifolds, fuel pump, oil pan, water pump and many others. If it is a fastener for the exterior of the engine, it is probably in this kit. Individually bagged and labeled for simplified installation.

MD2348 1964-67 383, 440..... 199.99 kit
MD2349 1964-67 273, 318..... 136.99 kit
MD2350 1966-67 426 Hemi..... 289.99 kit
MD2351 1967-70 340..... 146.99 kit
MD2352 1968-69 426 Hemi..... 324.99 kit
MD2353 1968-69 383, 440..... 199.99 kit
MD2354 1968-70 273, 318..... 146.99 kit
MD2355 1969-71 440 Six Pack..... 227.99 kit
MD2356 1970 340 Six Pack..... 178.99 kit
MD2357 1970 426 Hemi..... 346.99 kit
MD2358 1970-74 383, 440..... 199.99 kit
MD2359 1971 426 Hemi..... 367.99 kit

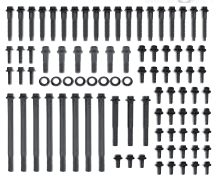

MN2098

Made in USA

Engine & Accessory Fastener Sets

These engine & accessory fastener sets provide everything needed to attach most engine components and accessories. Available with black oxide finish for traditionalists or in 300 series stainless steel for those wanting extra corrosion resistance and luster. Sets include fasteners for the intake manifold, valve covers, thermostat housing, alternator bracket, distributor bracket, motor mounts, oil pan, coil bracket, headers, front cover, water pump, and fuel pump bolts. Made in USA.

Black Oxide Hex Head
MN2094 318, 340 & 360 Wedge..... 172.99 set
MN2098 383 & 440 Wedge..... 164.99 set
Black Oxide 12 Point Head
MN2095 318, 340 & 360 Wedge..... 172.99 set
MN2099 383 & 440 Wedge..... 164.99 set
Stainless Steel Hex Head
MN2092 318, 340 & 360 Wedge..... 219.99 set
MN2096 383 & 440 Wedge..... 209.99 set
Stainless Steel 12 Point Head
MN2093 318, 340 & 360 Wedge..... 219.99 set
MN2097 383 & 440 Wedge..... 209.99 set

Cylinder Heads



Mopar Performance Small Block Cylinder Heads

Based on the Magnum R/T big-valve head design, this head is machined to fit 318/340/360 Mopar small block intake manifolds through 1991. Outflows the original "X" and "J" casting 340/360 heads.

Note: Shipped overweight.

MN1984 small block..... 639.99 ea



Mopar Performance Cast Iron Big Block Cylinder Heads

Stage V cast iron cylinder head for big block wedge engines. Feature heat crossover for improved drivability. Uses standard big block valve gear, gaskets and valve covers. For use with 6-bolt valve covers, rocker shaft pedestals cast-in and offset intake rockers.

Note: Shipped overweight.

MN1985 big block..... 699.99 ea



1962-64 Mopar Performance Max Wedge Cylinder Heads

Designed to replace 1962-64 Max Wedge heads these cast iron heads feature a large port window and a revised short side radius exhaust port for increased flow. Features 2.08" intake, 1.88" exhaust, a closed combustion chamber, six-bolt valve covers, and cast-in pedestals.

Note: Shipped overweight.

MN1982 1962-64 Max Wedge..... 919.99 ea



MN2871

1966-71 Mopar Performance Hemi Cylinder Heads

New Mopar Performance cylinder heads for Hemi engines. Each attaches as original and cast iron heads feature the same outward appearance as the original 1966-1971 heads, except for shape of alternator boss. All components attach the same as original. Features 170 cc combustion chamber and 2.25" intake and 1.94" exhaust valve machining. Includes valves, springs, retainers and keepers.

Note: Shipped overweight.

MN2871 1966-71 aluminum head..... 1839.99 ea

MN1983 1966-71 cast iron head..... 1825.99 ea



E60779



E60189



E60929

1961-85 Edelbrock Cylinder Heads

318, 340, 360ci Chrysler

Performer RPM Chrysler heads deliver outstanding performance in non-emission 1967-91 Chrysler 318-340-360ci engines. Designed for non-emission 1968-73 340ci Chrysler, RPM Chrysler 340 heads have chambers machined .060" for clearance with early high-compression engines. These heads are capable of 417 horsepower and 397 ft/lbs. of torque on pump gas with an Edelbrock Performer RPM intake manifold and matching camshaft. Sold individually.

Important: Not compatible with 1970 340 7A engine. Bare heads will have valve guides & seats installed, but will require final sizing and a valve job to match the valves you will be using. Recommend 14mmx3/4" reach spark plugs with flat gasket seat (Champion RC12YC)

Note: Not legal for sale or use on pollution controlled motor vehicles. Shipped overweight.

No further discounts apply.

Bare Head

E60769 1967-85 Performer RPM..... 711.99 ea

E60199 1968-73 RPM Chrysler 340..... 744.99 ea

Complete Head

E60779 1967-85 Performer RPM..... 849.99 ea

E60179 1968-73 RPM Chrysler 340..... 889.99 ea

Head Bolt Kit

E8555 1967-85 for Edelbrock heads..... 124.99 set



361, 383, 400ci Chrysler

Performer RPM Chrysler heads deliver outstanding performance in non-emission 1961-79 Chrysler 361-440ci Wedge engines. 210cc intake ports that flow 291 cfm, 70cc exhaust ports that flow 217 cfm at .600" lift. Your choice of 84cc chambers or 88cc chambers that are machined .100" for clearance with quench dome style pistons. Angled spark plugs for superior combustion. Sold individually.

Important: Some headers will not clear angled spark plugs. Bare heads will have valve guides & seats installed, but will require final sizing and a valve job to match the valves you will be using. Recommend 14mmx3/4" reach spark plugs with flat gasket seat (Champion RC12YC)

Note: Not legal for sale or use on pollution controlled motor vehicles. Shipped overweight.

No further discounts apply.

Bare Head

E60919 1961-79 84cc..... 749.99 ea

E60149 1961-79 88cc..... 769.99 ea

Complete Head

E60929 1961-79 84cc..... 854.99 ea

E60189 1961-79 88cc..... 909.99 ea

Head Bolt Kit

E8591 1961-79 for Edelbrock heads..... 149.99 ea



Victor Max Wedge Heads

Intake ports are machined to match Max Wedge intake manifolds for RB competition big-block Chrysler models. Intake ports are raised .650", exhaust ports are raised .250" for improved flow. The intake flange is extended .950" to eliminate the need for intake spacer plates. Exhaust flange is extended .300" from stock (same as Mopar Stage 6) featuring dry exhaust bolt holes with Helicoil® thread inserts. Sold without springs or retainers; use recommended springs to match your cam.

Note: Offset intake rockers required, exhaust side accepts standard-spec rockers. May require additional pushrod hole clearance for some combinations. Bare heads will have valve guides & seats installed, but will require final sizing and a valve job to match the valves you will be using. These heads require the use of a 14mm, 3/4" reach, flat gasket spark plug with a heat range appropriate to your application. Shipped overweight. No further discounts apply.

Bare Head

E77939 no valves..... 814.99 ea

Complete Head

E77949 2.20" intake / 1.81" exhaust valves..... 891.99 ea



Cylinder Head Hardware



E2086



1968-79 Edelbrock Big Block Power Package Top-End Kit

To get great performance out of any engine, the components must work together. Since the early 1980s, the Edelbrock Total Power Package System has been the solution to the parts matching puzzle for many street performance enthusiasts. Each power package includes: Intake manifold, camshaft & lifter kit, cylinder heads, timing chain & gear, head bolt set, intake bolt set and gaskets. Get all of your power package components in one box with an Edelbrock Power Package Top-End Kit.

Note: Not legal for sale or use on pollution controlled motor vehicles. No further discounts apply.

E2086	1968-79	383ci, 421hp & 417 ft/lbs	2539.99 kit
E2087	1968-79	440ci, 482hp & 528 ft/lbs	2509.99 kit

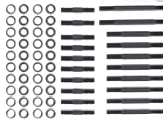

MN2090



Cylinder Head Hardware Sets

These cylinder head bolts feature a wide-flanged, reduced-wrenching hex head to allow you to re-torque the cylinder head without removing the valve train. These bolts are rated 180,000 psi and come complete with hardened parallel-ground washers. For engines that are serviced quickly and frequently, choose the premium 8740 alloy stud sets which are rated 200,000 psi and allow quick, accurate alignment of the cylinder head and gasket. Made in USA.

With Hex Head Bolts or Nuts

273-360 Small Block Engines	
MN2088 bolts	84.99 set
MN2090 studs	134.99 set
318/340/360 Small Block Engines	
AR1401 studs W2/W-2 econo	154.99 set
AR1416 bolts W2 or W-2 econo	77.99 set
AR1402 studs W5-W7 heads	164.99 set
AR1417 bolts W5-W7 heads	77.99 set
AR1418 bolts Magnum	92.99 set
AR1403 studs Edelbrock RPM heads	134.99 set
AR1404 studs B1-B4 heads	159.99 set
383-440 Big Block Engines	
MN2089 bolts factory heads	97.99 set
MN2089 bolts Edelbrock RPM heads	97.99 set
MN2091 studs factory heads	194.99 set
MN2091 studs Edelbrock RPM heads	194.99 set
AR1419 bolts Edelbrock Victor heads	101.99 set
AR1409 studs Indy 440 heads	199.99 set
AR1420 studs Indy 440 heads	96.99 set
426 Hemi	
AR1410 studs 7/16"	244.99 set
AR1421 bolts 7/16"	261.99 set
AR1411 studs 1/2"	244.99 set

With 12-Point Bolts or Nuts

273-360 Small Block Engines	
AR1405 studs	194.99 set
318/340/360 Small Block Engines	
AR1406 studs W2 or W-2 econo	194.99 set
AR1407 studs W5-W7 heads	204.99 set
AR1408 studs B1-B4 heads	199.99 set
383-426 Big Block Engines	
AR1412 studs factory heads	234.99 set
AR1412 studs Edelbrock RPM heads	234.99 set
AR1422 bolts factory heads	89.99 set
AR1422 bolts Edelbrock RPM heads	89.99 set
AR1413 studs Indy 440 heads	229.99 set
426 Hemi	
AR1414 studs 7/16"	239.99 set
AR1415 studs 1/2"	299.99 set
5.7L, 6.1L & 6.4L Hemi	
AR2401 studs Hemi	394.99 set

Engine Block to Head Dowel Pins

These steel dowel pins fit into the deck of the cylinder heads during assembly. These should be replaced whenever the deck is surfaced on a block. Comes in a set of 4, one set required per engine. These may also be used for the timing cover locating dowels. Use 2 dowels per engine for this purpose. Made from steel.

MN2188 all set of 4	9.99 set
---------------------	----------



MN2055

Mr. Gasket Ultra-Seal Head Gaskets

Ultra-Seal head gaskets have a 5 layer composite construction with graphite inner core and steel outer layers. These multi-layer gaskets transfers heat away from hot spots preventing gasket burn-out. They are coated with high temperature silicone to ensure sealing of engine fluids. Will not indent aluminum cylinder heads.

.028" Compressed Thickness, 4.140" Bore	
MN2053 1967-76 273-360	24.99 ea
.038" Compressed Thickness, 4.140" Bore	
MN2054 1967-76 273-360	44.99 ea
.038" Compressed Thickness, 4.450" Bore	
MN2055 1960-76 361-440 exc. Hemi	44.99 ea

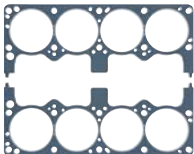

MN1986

Mopar Performance Head Gaskets

Thick, 0.040" to 0.042" gaskets can be used for replacement or competition applications up to 12.5:1 compression ratio. Sold as an engine set.

Small Block	
MN1986 up to 4.060" bore	82.99 pr
Big Block	
MN1988 up to 4.380" bore	79.99 pr
MN1989 up to 4.420" bore	72.99 pr

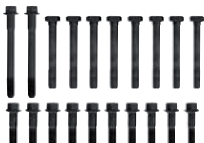

Mopar Performance Small Block Head Bolt Set

Set of 20 bolts that fits 318/340/360 "LA" Engines up to 1992.

MN1991	169.99 set
--------	------------



Mopar Performance Big Block Head Bolt Set

Set of 34 bolts that fits all big blocks except for Hemi.

MN1990	82.99 set
--------	-----------

Camshaft Sets



Edelbrock Performer Plus Camshaft Kits

Designed for optimum torque from the low-end to the mid-range, Performer® Plus camshaft packages match with Performer® manifolds for vehicles operating from idle to 5500 RPM. They are smooth idling cams that provide for a major improvement in throttle response and torque. All camshafts come with hydraulic lifters, assembly lube and instructions.

Note: Not legal for sale or use on pollution controlled motor vehicles.

No further discounts apply.

Item #	Year	Application	Duration	Lift	Price
E2177	1967-84	318, 340, 360	270°/270°	.420°/.420°	219.99 set
E2192	1968-78	383, 400, 440	270°/280°	.420°/.442°	254.99 set



MN1999

Mopar Performance Small Block "Purple" Camshaft Sets

All Mopar "Purple Shaft" performance camshafts are designed, developed, dyno tested and track-tested by engineers for increased power and rpm potential while maintaining reliability and the best possible low-speed characteristics, including torque and idle quality. Fits all LA family 273, 318, 340 and 360 engines. Each package contains the camshaft, instruction sheet, and tappets.

Note: Mopar recommends the use of a high zinc oil for maximum durability for flat tappet camshafts.

Hydraulic Camshaft Sets

Item #	Adv. Duration	Lift	Overlap	Centerline	Price
MN1997	248/256	0.4100/0.425	32	110°	259.99 set
MN1998	268/276	0.4290/0.444	44	114°	299.99 set
MN1999	260/268	0.4300/0.450	44	110°	259.99 set
MN2000	268/272	0.4500/0.4455	50	110°	259.99 set
MN2001	238/238	0.4740/0.474	60	110°	259.99 set
MN2002	284/284	0.4840/0.484	68	108°	419.99 set
MN2003	292/292	0.5080/0.508	76	108°	259.99 set

Mechanical Camshaft Sets

Item #	Adv. Duration	Lift	Overlap	Centerline	Price
MN2067	284/284	0.5280/0.528	60	112°	269.99 set
MN2068	296/296	0.5570/0.557	76	110°	269.99 set
MN2069	312/312	0.5900/0.590	104	106°	269.99 set



MN2004

Mopar Performance Big Block Purple Shaft Camshaft Kits

All Mopar Purple Shaft performance camshafts are designed, developed, dyno'd and track-tested by engineers for increased power and rpm potential while maintaining reliability and the best possible low-speed characteristics, including torque and idle quality. Big Block models included are Chrysler B/RB (361, 383, 400, 413, 426 Wedge and 440). These Purple Shaft cams offer the best horsepower-to-dollar-sent value. Each package contains the camshaft, instruction sheet, and tappets. Hydraulic camshafts use a 1 bolt design and Mechanical camshafts use a 3 bolt design.

Note: Mopar recommends the use of a high zinc oil for maximum durability for flat tappet camshafts.

Hydraulic Camshaft Sets

Item #	Adv. Duration	Lift	Overlap	Centerline	Price
MN2004	268/284	0.4500/0.458	46	115°	369.99 set
MN2005	272/272	0.4550/0.455	48	112°	389.99 set
MN2006	280/280	0.4740/0.474	60	110°	249.99 set
MN2007	284/284	0.4840/0.484	68	108°	384.99 set
MN2008	292/292	0.5090/0.509	76	108°	409.99 set
MN2013	241/241	0.4840/0.475	N/A	106°	269.99 set
MN2014	241/241	0.4840/0.475	N/A	106°	249.99 set

Mechanical Camshaft Sets

Item #	Adv. Duration	Lift	Overlap	Centerline	Price
MN2009	284/284	0.5280/0.528	60	112°	259.99 set
MN2010	296/296	0.5570/0.557	76	110°	279.99 set
MN2011	312/312	0.5900/0.590	104	106°	249.99 set
MN2012	324/324	0.6200/0.620	112	106°	259.99 set

Camshaft Bolt Set

This set includes a replacement bolt and special washer for attaching the camshaft sprocket to the camshaft. This strong, grade 8 nylon washer and bolt fit all years and all engines with single bolt sprocket.

Note: Will not work with 3 bolt cams.

MN2414 all 15.99 set



Edelbrock Performer RPM Camshaft Kits

Designed for high-performance street applications, Performer® RPM cams provide power from 1500 to 6500 RPM. These hydraulic lifter camshafts are dyno-matched to Performer® RPM manifolds for high RPM horsepower while maintaining acceptable low-end torque. With 10-12 inches of manifold vacuum at idle, Performer® RPM cams have more lift and duration than most street camshafts.

Note: Not legal for sale or use on pollution controlled motor vehicles.

No further discounts apply.

Item #	Year	Application	Duration	Lift	Price
E7177	1967-84	318, 340, 360	308°/318°	.488°/.510°	301.99 set
E7194	1968-78	383, 400, 440	300°/308°	.480°/.495°	309.99 set



Edelbrock Rollin' Thunder Performer Plus Camshafts

Designed for street high-performance applications, Performer® RPM cams provide power from 1500 to 5500 RPM. These hydraulic roller lifter camshafts reduce friction, virtually eliminate break-in problems and permit higher valve velocities for increased performance. Intended for use with OEM or Edelbrock hydraulic roller lifters sold separately.

Note: Not legal for sale or use on pollution controlled motor vehicles.

No further discounts apply.

Item #	Year	Application	Duration	Lift	Price
E2206	1968-78	383, 400, 440	240°/248°	.540°/.545°	449.99 ea



Camshaft Thrust Buttons

Camshaft thrust buttons ride between the front of the timing gear and the back of the timing cover. They can be shimmed to achieve proper end play. These come in either steel roller bearing style button or nylon thrust button. These fit 1960-76 383-440 and 1966-71 426 Hemi with 3-bolt cam gears. MN2120 .715" roller style. 21.99 ea MN2121 .735" nylon style. 11.99 ea

Camshaft Wear Plate

This wear plate bolts to the front of the block and regulates the cam thrust in the engine. Made from steel and moly coated to last with a bearing thickness of 0.30". This item always wears-out and should be changed whenever replacing the cam or rebuilding the engine. MN2123 big block..... 15.99 ea



Your Choice of Four Convenient Sets to Meets Your Specific Needs!

Important: On small block applications, High Energy™ Cams may be used with stock valve springs and lifters. However these components must be in good operating condition. In order to protect your camshaft warranty and for maximum performance benefit, we recommend replacing stock valve springs and lifters with a high performance set from Classic Industries.



A - Camshaft Only

The camshaft only set includes camshaft, instructions, assembly lube and decals



B - Cam and Lifters

Order the cam and lifter set to add a matched set of lifters to your camshaft



C - Small Set

Order the small set for cam and lifter set plus timing chain and gear



D - Complete Set

Complete set includes cam, lifters, timing chain & gear valve springs and retainers, valve locks, valve stem seals

High Energy™ Hydraulic Cams for Your Mopar Daily Driver!

All High Energy™ designs are totally streetable hydraulic cams. They will produce 10 to 30% more power than a stock cam throughout the RPM range. Each cam has a particular RPM range in which it works best. By selecting the cam that best suits your driving needs, exceptional power increases can be expected. High Energy™ Cams work great for everyday driving without the "bad" side effects normally found with

other hydraulic cams. High Energy™ cams produce more power, are more efficient and do not affect the engine's idle characteristics to the point of making your car undrivable. High Energy™ Cams will not affect any vacuum or power accessories such as power brakes, air conditioning or steering. A variety of cams and kits are available for small block and big block applications.

Item #	Application	RPM Range	Adv Dur	Lift	A - Camshaft	B - Cam & Lifters	C - Small Set	D - Complete Set
202082	273-360 ci	800-4800	252"/252"	.425"	119.99 ea	189.99 set	224.99 set	324.99 set
202102	273-360 ci	1200-5200	260"/260"	.440"	119.99 ea	189.99 set	224.99 set	324.99 set
202122	273-360 ci	1500-5500	268"/268"	.454"	119.99 ea	189.99 set	224.99 set	379.99 set
212124	383-440 ci	800-4800	252"/252"	.425"	139.99 ea	214.99 set	249.99 set	394.99 set
212134	383-440 ci	1000-5000	260"/260"	.440"	139.99 ea	214.99 set	249.99 set	394.99 set
212154	383-440 ci	1200-5200	268"/268"	.454"	139.99 ea	214.99 set	249.99 set	369.99 set

Magnum™ Hydraulic Cams for High Performance Mopar Engines!

The Magnum™ Cam is a great cam for high performance driving in street machines. Provides 30-70% more horsepower and a rough and ready to rumble idle in small block or big block Mopar applications. The Magnum™ will not affect power accessories, but should be used with headers and a change in rear end gear ratios. This is the perfect hydraulic cam for cruising. **Important:** Vendor states that engine must use recommended valve springs. Use of stock valve springs could

cause damage when used with these camshafts. Complete sets include valve springs.
 * Needs 90116 valve springs if not purchasing the complete set.
 ** Needs 9516 valve springs if not purchasing the complete set. Heads must be machined
 *** Needs 91116 valve springs if not purchasing the complete set.
 **** Needs 92416 valve springs if not purchasing the complete set. Heads must be machined

Item #	Application	RPM Range	Adv Dur	Lift	A - Camshaft	B - Cam & Lifters	C - Small Set	D - Complete Set
202144*	273-360 ci	1800-5800	270"/270"	.470"	139.99 ea	199.99 set	259.99 set	399.99 set
202324*	273-360 ci	2500-6000	280"/280"	.480"	139.99 ea	214.99 set	259.99 set	399.99 set
202434**	273-360 ci	3000-6500	292"/292"	.501"	139.99 ea	214.99 set	259.99 set	431.99 set
213064***	383-440 ci	1800-5500	270"/270"	.470"	139.99 ea	214.99 set	259.99 set	414.99 set
212374***	383-440 ci	2500-5800	280"/280"	.480"	139.99 ea	214.99 set	259.99 set	414.99 set
212424****	383-440 ci	3000-6200	292"/292"	.501"	139.99 ea	214.99 set	259.99 set	489.99 set
212434****	383-440 ci	3500-6500	305"/305"	.525"	139.99 ea	214.99 set	259.99 set	444.99 set

Xtreme Energy™ Hydraulic Cams for Street/Strip Mopar Engines!

Xtreme Energy™ Cams are Comp Cams' newest series of hydraulic cams. They are designed to take advantage of the latest improvements in valve train components and the newest developments in camshaft design. Xtreme Cams can be used in any street/strip application where both throttle response and top end horsepower are desired. Increases horsepower from 20-70% over stock.

Important: Vendor states that engine must use recommended valve springs. Use of stock valve springs could cause damage when used with these camshafts. Complete sets include valve springs.

* Needs 90116 valve springs if not purchasing the complete set.
 ** Needs 92616 valve springs if not purchasing the complete set.
 *** Needs 91116 valve springs if not purchasing the complete set

Item #	Application	RPM Range	Adv Dur	Lift	A - Camshaft	B - Cam & Lifters	C - Small Set	D - Complete Set
202203*	273-360 ci	800-4800	250"/260"	.432", .444"	129.99 ea	129.99 set	239.99 set	339.99 set
202213*	273-360 ci	1000-5200	260"/268"	.447", .455"	129.99 ea	204.99 set	239.99 set	339.99 set
202223*	273-360 ci	1300-5600	262"/270"	.462", .470"	129.99 ea	204.99 set	239.99 set	359.99 set
202233**	273-360 ci	1600-5800	268"/280"	.477", .480"	129.99 ea	204.99 set	239.99 set	369.99 set
212204**	383-440 ci	600-4800	250"/260"	.432", .444"	139.99 ea	214.99 set	249.99 set	469.99 set
212214**	383-440 ci	1000-5200	256"/268"	.447", .455"	139.99 ea	214.99 set	259.99 set	369.99 set
212224***	383-440 ci	1300-5600	262"/270"	.462", .470"	139.99 ea	214.99 set	259.99 set	459.99 set
212234***	383-440 ci	1600-5800	268"/280"	.477", .480"	139.99 ea	214.99 set	259.99 set	494.99 set

Valve Covers



MN2528

1964-76 OE-Style Valve Covers

Correct reproduction valve covers for 1964-76 models with small or big block engines. These valve covers are manufactured to original specifications and feature a quality fit. All valve covers are unpainted except where chrome finish is noted.

Note: 1971 models through 12/1970 used 1970-style valve covers.

Small Block

Unpainted Valve Covers

MN2528	1970	340 6 bbl.....	179.99 pr
MN2527	1970-71	except 340 6 bbl.....	179.99 pr
MN2529	1972-76	all.....	179.99 pr

Big Block

Unpainted Valve Covers

MN2530	1964	426 Max Wedge.....	179.99 pr
MN2531	1964-65	361, 383 & 413.....	179.99 pr
MN2533	1966-67	361, 383 & 440.....	179.99 pr
MN2535	1968	383 & 440 Hi-Po.....	179.99 pr
MN2536	1969	all.....	179.99 pr
MN2537*	1970	all.....	179.99 pr
MN2538	1971-76	all.....	179.99 pr

Chrome Valve Covers

MN2532	1964-65	426 Wedge.....	299.99 pr
MN2534	1967	440 Hi-Po.....	299.99 pr
MN2534	1967-68	383 for A-Body.....	299.99 pr



Small Block Chrome Valve Covers

Direct Connection logo set includes two valve covers and grommets. These are stamped from brand new tooling to ensure sealing around the cylinder heads. Does not include gaskets, screws or baffling.

MN2027 small block..... 149.99 set



Mopar Magnum Small Block Valve Covers

Cast aluminum valve covers with a black wrinkle finish and the Mopar Magnum logo.

MN2029 small block..... 229.99 set



OEM Black 426 Hemi Valve Cover Set

Original equipment for all 1966 thru 1969 426 Hemi engines, these stamped steel black wrinkle covers have the spark plug wire brackets and rubber coated alternator wiring looms. The set includes left and right valve covers, chrome breather caps, metal PCV valve, chrome PCV cap, two gaskets and hold down studs and nuts.

MN1042 1966-69 Hemi..... 929.99 set



Mopar Performance Hemi Valve Covers

1966 and later street Mopar Performance Hemi valve covers. Painted black wrinkle and finished with Hemi logo cast in. For single-plug cylinder head applications. Uses Street Hemi valve cover rail. Gaskets included. Takes MN2035 oil cap.

MN2031..... 1089.99 set



T9299

Chrome Small & Big-Block Valve Covers

Chrome valve covers for all small and big block Chrysler engines, excluding Hemi. All are chromed and baffled. Use 1/4"-20 fasteners. 5 required per cover for small block, 6 required per cover for big block; sold separately.

Note: Not legal for sale or use in California on pollution controlled motor vehicles.

Small Block Valve Covers

Fits 273, 340 and 360 for 64-73 and 318 engines 1967 and up. 1 year manufacturer's warranty.

T9298 Chrome baffled..... 54.99 pr

Big Block Chrysler Valve Covers

Fits 383, 413, 426 wedge and 440 (excluding Hemi). 1 year manufacturer's warranty.

T9299 Chrome baffled..... 49.99 pr



MN1035

Mopar Performance Valve Covers

These valve covers are perfect for that show-car look and feature the Mopar Performance logo. Cast aluminum covers are more rigid than stamped valve covers and help prevent valve cover leaks. Set includes two valve covers and oil filter caps (does not include bolts or gaskets unless noted).

Note: The cast aluminum valve covers require the PCV and breather cap holes must be machined open.

Polished Cast Aluminum - "Mopar Performance"

MN1035 small block..... 199.99 pr

MN1036 big block..... 209.99 pr

Black Cast Aluminum - "Mopar Performance"

MN1037 small block..... 159.99 pr

MN1038 big block..... 179.99 pr

As Cast Aluminum - "Mopar Performance"

MN2028 small block, gaskets & bolts..... 139.99 pr

MN2030 big block, inc. gaskets & bolts 149.99 pr

Chrome Stamped Steel - Pentastar Logo

MN1040 big block..... 159.99 pr



Elite Series Aluminum Valve Covers

These heavy gauge die-cast aluminum valve covers have a polished finish for a custom look. The raised fins are accented by a black matte background, then detailed with Allen hex heads that create a two-piece look in a one-piece valve cover. These high profile (3-13/16" tall) valve covers are designed to clear roller rockers and valvetrain components.

Note: For small block only. No further discounts apply.

E4295 1965-76 318-360..... 154.99 pr



E4176



E41923

Classic Aluminum Valve Covers

Edelbrock first made these valve covers in the late 1950's and they're still in style. Made of heavy gauge sand-cast aluminum, these valve covers are designed to clear roller rockers. Available in polished or black powdercoated finish.

Note: No further discounts apply.

Small Block 3-3/4" tall

E4176 polished..... 289.99 pr

E41763 black..... 279.99 pr

Big Block 4" tall

E4192 polished..... 279.99 pr

E41923 black..... 279.99 pr



E4495



E4495

1960-76 Signature Series Valve Covers

These quality baffled valve covers accept all emissions equipment, including PCV valve. Rubber grommets for the breather and PCV holes are included. Matching breathers are sold separately. Available in chrome or black powdercoated finish.

Important: Tall valve covers clear most roller rockers and valvetrain components except stud guides.

Note: No further discounts apply.

Small Block

E4495 1965-76 tall profile, chrome..... 54.99 pr

E4473 1965-76 tall profile, black..... 59.99 pr

Big Block

E4491 1960-76 tall profile, chrome..... 59.99 pr

E4493 1960-76 tall profile, black..... 59.99 pr



Valve Covers

MOROSO



MN2137

Moroso Tall Chrome Valve Covers

Moroso chrome valve covers are a classic design that will take you back to when muscle cars ruled the road. The Moroso name is stamped into the top of the valve covers and include 2 breather/filler cap grommets. Tall design with baffles. Made from stamped steel.

Small Block and W2 Heads	69.99 pr
MN2136	
Big Block	84.99 pr
MN2137	



MN2139

MOROSO

Aluminum Small Block Valve Covers

Moroso fabricated aluminum small block valve covers. Fabricated entirely from one piece of quality aluminum that makes them ultra lightweight. One piece billet rail is 3-3/4" tall that is CNC machined to ensure a precision flat surface for superior sealing that allows the engine to pull greater vacuum for improved ring seal and power. Tall enough to clear most rocker combinations. Fasteners are included.

MN2138	w/o breather	469.99 pr
--------	--------------	-----------

Accessories

MN2140	PCV grommet .095"	4.99 pr
MN2141	PCV grommet/baffle .095".....	3.59 ea
MN2142	breather grommet/baffle .095"	4.99 ea



MN2524

Fabricated Aluminum Racing Valve Covers

Update and dress your engine compartment with these beautiful fabricated aluminum valve covers with rail. Get the a modern look at the price of yesteryear.

MN2523	small block	159.99 pr
MN2524	big block	169.99 pr



Polished Cast Big Block Valve Covers

Fully polished cast aluminum valve covers give your engine a sleek, modern look. Designed for aftermarket cylinder heads with 90° valve cover holes. Sold as a pair. Made in USA.

Note: Modification may be necessary to mount these valve covers to original heads and is not recommended.

MN2424	big block	139.99 pr
--------	-----------	-----------



Fabricated Aluminum Big Block Valve Covers

These fabricated aluminum valve covers are fully TIG-welded from sheet aluminum. After the covers are welded, the entire flange is milled to guarantee a flat, straight surface. These covers are designed to allow you to position the breathers or oil caps exactly where you need them with a simple hole saw or punch. Reduced head diameter valve cover bolts or studs are recommended. Made in USA.

Note: Powder coating or polishing recommended for removal of minor surface imperfections.

MN2423	big block	189.99 pr
--------	-----------	-----------

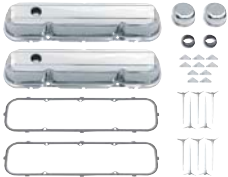

Small Block Engine Dress Up Kit

These dress up kits for small block engines include: 2 baffled chrome valve covers, 10 mini hold down tabs, 10 wing nuts for valve covers, 2 chrome push-in breather caps, 2 breather grommets and 2 valve cover gaskets. Covered by a 1 year manufacturer's warranty.

T3050	engine dress up kit	119.99 kit
-------	---------------------	------------



DF1700

DF1701

Dual Flow Adjustable PCV Valve

Does your PCV valve match your engine? Stock PCV valves are not designed to work with modified high performance engines due to their altered vacuum profiles. A mismatched PCV valve can cause oil to push out of your breathers, cause oil leaks, or contaminate your oil with piston blow-by gasses. Now you can manage your crankcase pressure with this fully 6061-T6 billet aluminum dual-flow PCV valve. Once adjusted, the valve will provide sufficient crankcase ventilation during both idle and cruise. Valve fits 3/4" ID valve cover grommets and 3/8" ID PCV lines. An available adapter allows for installation on 3/8" ID inline applications. PCV valve set includes valve, vacuum gauge fitting, allen wrench, and detailed instructions. Made in USA.

Note: Not intended for use on pollution-controlled vehicles.

DF1700	adjustable PCV valve	128.99 ea
DF1701	billet inline adapter	21.99 ea
DF1702	PCV valve rebuild kit	14.99 kit



T6068



T6067

Aluminum PCV Valve

This aluminum hose PCV valve is just what you need to finish your engine bay detailing project. Manufactured with a 3/4" neck for 3/4" ID grommets.

Note: Rubber grommet not included.

T6068	polished PCV valve	19.99 ea
T6067	chrome PCV valve	23.99 ea



Universal Crankcase Evacuation System

This universal crankcase evacuation system is designed for high performance and racing applications. It replaces the standard PCV to air cleaner system by connecting to the exhaust system allowing exhaust pressure to pull the from the crankcase. Includes two simple pipes with one-way valves that weld to the header collectors and are connected to dual valve cover breathers.

Note: Not for use on pollution controlled vehicles. For valve covers with 1-1/4" holes. Hoses are not included.

20501	universal crankcase evacuation system	34.99 set
-------	---------------------------------------	-----------



25051



25131

Oil Catch Tanks

An oil catch tank works as a filter for the PCV system. It connects between an engine's crankcase vent and the induction system, filtering oil and moisture before they can enter the intake manifold, reducing emissions and carbon buildup. These fabricated aluminum tanks come complete with mounting tabs, barbed inlet/outlet fittings, a drain plug, and a sight glass to let you know when it's full.

25031	round 34oz sealed tank	56.99 ea
25051	round 17oz tank w/breather filter	56.99 ea
25131	rectangular 68oz sealed tank	111.99 ea

Valve Cover Components

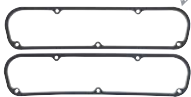

MN2036

Mopar Performance Valve Cover Gaskets

Mopar Performance valve cover gaskets for small block and big block applications. New gaskets are recommended when removing or replacing your valve covers.

Small Block Engines

MN2036 1964-76 LA small block 28.99 pr

MN2037 1992-03 Magnum 25.99 pr

Hemi Engines

MN1046 1966-71 Hemi 49.99 pr



MN1055

1964-76 Fel-Pro Valve Cover Gaskets

Replacement valve cover gaskets for 1964-76 Mopar models with small block, big block or Hemi engines. Each gasket will fit and function as original to prevent oil from escaping through the valve cover.

Small Block

MN1055 1964-76 Fel-Pro 14.99 pr

Big Block

MN1056 1964-76 Fel-Pro 14.99 pr

426 Hemi

MN1057 1966-71 Fel-Pro 21.99 pr



MN2066

1963-76 Valve Cover Gaskets

Mr. Gasket performance valve cover gaskets. Manufactured from high-density cork/rubber blend gasket material that is 3/16" thick and provides excellent sealing and durability. New gaskets are a must when removing or replacing your valve covers. Made for OE replacement, high performance, street, drag race and oval track use.

MN2066 1964-76 273-360 19.99 pr

MN2073 1963-76 361-440 exc. Hemi. 19.99 pr

MD2320 1966-71 Hemi 44.99 pr



MN2072

Mr. Gasket Ultra-Seal Valve Cover Gaskets

Mr. Gasket performance valve cover gaskets. Manufactured from high-density cork/rubber blend gasket material that has a black latex rubber coating applied to the outside of the gasket to help seal minor flange irregularities and eliminate the possibility of oil leakage. These are 3/16" thick. New gaskets are a must when removing or replacing your valve covers. Made for OE replacement, high performance, street, drag race and oval track use.

MN2072 1964-76 273-360 21.99 pr

MN2074 1963-76 361-440 exc. Hemi. 21.99 pr



MN1048



Valve Cover Hardware Sets

Finish off your valve covers with these valve cover fastener sets. Hemi hardware set includes studs and nuts, while others include bolts. Other items included where stated.

426 Hemi Valve Cover Set

A complete set of 20 studs and nuts to fit 1966-71 426 Hemi heads to retain factory valve covers. These have the correct finish and KEPS nuts. For use with all stamped sheet metal covers. Nuts available individually.

MN9200 1966-70 Hemi 59.99 set

MN9201 1971 Hemi 89.99 set

MN1044 nut only 2.99 ea

Valve Cover Accessory Set

Contains 12 chrome plated screw and washer assemblies, 1 chrome plated oil filler cap and 2 rubber grommets.

MN1048 accessory kit 21.99 set

Chrome Valve Cover Bolt Set

Includes 4 bolts and 4 washers. Need 3 sets for 1 pair of valve covers.

AK131A 1/4-20, 1" long 12.99 set

Valve Cover Spreader Set

Includes 4 chrome 4-1/2" wide spreader bars. Use two sets for V8 engines.

T4993 4 spreaders 5.99 set

Valve Cover Washer Set

Designed for stamped steel valve covers only. Set includes 12 chrome washers for 2 valve covers.

MN1508 except Hemi 11.99 set

Chrome Hold Down Set

Set includes 4 hold down washers. For all engines except Hemi.

Note: Need 3 sets for 2 valve covers.

T9067 set of 4 5.99 set



66006

66038

66650

Valve Cover Hold Down Nuts

Various styles of chrome hold down bolts sold in sets of 4 pieces.

T-Bar Wing Nuts

66005 3-1/2" tall, 1/4"-20 studs 9.99 set

T4936 5" tall, 1/4"-20 studs 12.99 set

Chrome Wing Nuts

41371 3-1/2" tall, 1/4"-20 studs 8.99 set

41381 3-1/2" tall, 5/16"-18 studs 8.99 set

Deluxe Wing Nuts

66006 4" tall, 1/4"-20 studs 9.99 set

66036 4" tall, 5/16"-18 studs 13.99 set

Mini Nuts

66038 1/4"-20 studs 8.99 set

66650 1/4"-20 studs 12.99 set



ST10072

ST10066

Replacement Oil Caps

High quality Stant service replacement oil caps in a variety of styles for small block and big block engines.

Push-In Style for 1.25" Hole

ST10072 OIL 1.99 ea

Twist-on Style with Tabs

ST10066 with ears 2.99 ea



E4405

E4204

Edelbrock Valve Cover Breathers

Elite Series

Elite series breathers are die-cast aluminum with a foam element. Available in 3 styles. Side mount and top mount breathers require drilling for installation.

Note: No further discounts apply.

E4204 push-in style w/foam 24.99 ea

E4214 push-in style w/o logo 25.99 ea

E4201 90° side mount w/foam 24.99 ea

E4202 30° top mount w/foam 29.99 ea

Signature Series

Signature Series inscribed breathers come with rubber grommets and match Signature Series chrome valve covers. Fit any 1-1/4" hole.

Note: No further discounts apply.

E4403 black w/o nipple 11.99 ea

E4405 chrome w/o nipple 8.99 ea

E4410 chrome w/90° nipple 8.99 ea

ENGINES & COMPONENTS

Valve Cover Components



Edelbrock

Signature Series Oil Fill Cap

Oil plugs feature recessed Edelbrock script and are designed to plug the oil fill hole on any of Edelbrock's Signature Series valve covers or any 1-1/4" diameter fill hole on similar designs. Chrome finish.

Note: No further discounts apply.

E4415 1-1/4" hole..... 7.99 ea



1970-76 Oil Filler Cap

Replacement chrome style oil cap, originally equipped on many Mopar engines from 1970-76.

T4804 1970-76..... 5.99 ea



Valve Cover Chrome Breather Cap

Mopar Performance valve cover chrome breather cap for Mopar cast aluminum valve covers to fill extra valve cover holes.

MN2033..... 11.99 ea



OE-Style Chrome Hemi Valve Cover Breather

Valve cover breather for the 1966 Hemi with clean air package and all 1967-69 high performance 340, 338, 440 and Hemi engines. Made to the OE dimensions, features high quality chrome finish with the correct internal screen mesh filter and proper "OIL" lettering on top.

MD2325 1966-69 chrome..... 85.99 ea



1964-69 Street Hemi Push-On Breather

Factory reissue of the push on breather used on 1964-69 426 Hemi models. It will fit all production style Hemi valve covers including Mopar Performance parts, chrome or black knirkle.

MN1053 1964-69 push-on breather..... 69.99 ea

1969 A-Body Hemi Superstock Breather

Reproduction breather cap for 1969 A-Body models fitted with Hemi Superstock engine. Designed and manufactured to factory specifications, each comes in the correct gray color for a truly authentic appearance. Sold as a pair.

MD2326 1969 Dart, Barracuda..... 101.99 pr



OEM Style Push-In Breather Cap

OEM chrome design. Fits valve covers with 1.25" diameter holes.

T9169 1.25" push-in..... 6.99 ea



1964-69 426 Hemi PCV Package Set

Factory reissue set contains one PCV cap, a PCV valve and nut and one PCV valve retaining spring. Also, can be used to service 60's era push on style PCV valves without their Hemi.

MN1052 1964-69 PCV package set..... 99.99 set



OE-Style Replacement PCV Valves

Reproduction PCV valve for various Mopar models. Note: *For models with steel valve covers.

Black Phosphate lower with Plastic Top
MD2321 1970-71 BB, w/grommet..... 39.99 ea
MD2322 1970-74 SB, w/grommet..... 31.99 set

Aftermarket PCV Valve
PCV180 1962-69 6, 8 cylinder..... 2.99 ea



PCV Valve And Breather Grommet Set

Licensed reproduction PCV valve and breather grommets. For steel valve covers only. Features all correct markings as original.

MD2323 1970-71 big block & Hemi..... 16.99 set
MD2324 1970-74 small block..... 14.99 set



MN1051

T4998

1961-76 Valve Cover Grommets

Various valve cover grommets for 1961-76 models with small or big block engines.

Breather Cap Grommet

MN1054 1962-76 all engines..... 4.99 ea

PCV Valve Grommet

MN1051 1961-74 1/2" all..... 4.99 ea

T4998 1961-74 3/4" ID x 1/4" OD... 1.99 ea



Big Block Valve Cover Grommet Set

Set of grommets for cast aluminum big block valve covers, except Hemi. Includes grommets for both valve covers.

MN1050 1961-74 grommet set..... 11.99 set



Mopar Performance Valve Stem Seals

1967 and later small block and 1965 and later big block except Hemi. Made of high-temp Viton material, these Valve Seals feature a full or semi-umbrella shape for best dual-purpose use. Helps prevent oil seepage down valve guides. Not recommended for use with dual valve springs. Sold in sets of 16.

MN1992..... 21.99 set



Valve Cover Baffle

Mr. Gasket valve cover plugs and grommets fit aftermarket stamped steel and aluminum valve covers. Made from neoprene to ensure a positive seal. The baffled grommet is special and replaces the stock grommet and it is designed to eliminate blow-by from non-baffled valve covers and will not work with stud girdles. Measure your valve cover inlet for accurate fit.

T9359 1 1/4" baffled..... 1.99 pr



Valve Cover Plug

Utility plug manufactured in rubber for use on valve covers with 1.25" diameter holes. Will plug up the opening hole when not using PCV or Oil filler cap.

G7229..... 1.99 ea

Edelbrock Intake Manifolds



E2176

Edelbrock Performer Family Intakes

Edelbrock Performer intakes are dual-plane intakes designed for street engines and are either stock replacement or street legal upgrades for your Mopar small or big-block engine. Performer intakes are best from idle to 5500RPM while Performer RPM and RPM Air-Gap intakes are best from 1500RPM to 6500RPM.

Note: No further discounts apply to all Performer Intakes.

Edelbrock Performer Intakes

Designed for street 318-340-360ci Chrysler V8s. E2176 is stock replacement/street legal part for 1966-72 V8s (and 1973 non-CA models) with OEM 4-bbl. carburetor except models equipped with EGR. E3776 is stock replacement/street legal part for 1972-87 small block engines with OEM 4-bbl. carb.

E2176 318-360 non-EGR natural finish 279.99 ea
E3776 318-360 w/EGR natural finish 304.99 ea

361, 383, 400

Designed for blocks that measure 7.75" across. For EGR, #E2186 is stock replacement/street legal part for 1972-78 model 400 V8s with OEM 4-bbl. carb. For non-EGR, #E2186 is stock replacement/street legal part for 1966-72 model engines with OEM 4-bbl. carb. (1973 non-CA); except stock equipped EGR.

E2186 361-400 EGR/non-EGR natural finish 274.99 ea

413, 426, 440

Designed for blocks that measure 8.75" across. For EGR, #E2191 is stock replacement/street legal part for 1972-79 440 V8s with OEM 4-bbl. carb. For non-EGR, #E2191 is stock replacement/street legal part for 1966-72 413, 426 (Wedge), 440 V8s with OEM 4-bbl. carb. (1973 non-CA); except stock equipped EGR. Will not fit 1962-64 Max Wedge heads.

E2191 413-440 EGR/non-EGR natural finish 251.99 ea

Edelbrock Performer RPM Intakes

Note: Not legal for sale or use on pollution controlled motor vehicles.

318, 340, 360

Designed for 340-360ci Chrysler V8s and 318ci engines with 340-360 cylinder heads, use of the latest technology in their dual-plane design results in both excellent low-rpm torque and outstanding high-rpm horsepower. Recommended for high-performance street and strip applications. Arrives 1975 and earlier water neck only. Will not accept stock Thermo-Quad carburetor. Will not fit 1992 and later Magnum engines. Match with Performer heads #E60779 for maximum performance.

E7176 340-360 non-EGR natural finish 314.99 ea

361, 383, 400

Designed for 361-383-400ci Chrysler engines. Dual-plane design results in excellent low-end torque and high-rpm power. High flow runner design will handle the popular strip combinations. For high-performance street/strip applications. Will not fit 1962-64 Max Wedge heads.

E7186 361-400 non-EGR natural finish 299.99 ea

413, 426, 440

Designed for 413-426-440ci Chrysler V8s. Dual-plane design results in excellent low-rpm torque and outstanding high-rpm horsepower. For high-performance street/strip applications. Will not fit 1962-64 Max Wedge heads.

E7193 413-440 non-EGR natural finish 269.99 ea

Edelbrock Performer RPM Air-Gap Intakes

Note: Not legal for sale or use on pollution controlled motor vehicles.

318, 340, 360

Designed for 340-360ci Chrysler V8s and 318ci engines with 340-360 cylinder head. Will not accept stock Thermo-Quad carburetor. Will not fit 1992 and later Magnum engines. Includes nitrous bosses. No provision for exhaust heated chokes and no exhaust crossover.

E7576 340-360 non-EGR natural finish 329.99 ea

E75764 340-360 non-EGR Endurashine finish 504.99 ea

E75763 340-360 non-EGR black powdercoated finish 444.99 ea

5.7L Hemi

Fits new 5.7 Hemi engine. Dual-Quad intake provides nostalgic look with modern power. Must be used in conjunction with Timing Control Module, sold separately.

E7528 5.7L HEMI natural finish 439.99 ea

E75284 5.7L HEMI Endurashine finish 579.99 ea



Edelbrock Torker Family Intakes

Torker family intakes offer the same performance as Performer intakes, but with Edelbrock's patented Air-Gap technology. Ideal output from 1500-6500RPM.

Note: No further discounts apply to all Torker Intakes.



E3010

Edelbrock Torker 383

Designed for blocks that measure 7.75" across. Great for street high-performance engines operating between 2500 and 6500 rpm where low-end torque is not a requirement.

Note: 50-state legal.
E3010 361-400 non-EGR natural finish 304.99 ea

Edelbrock Torker II

318, 340, 360
Designed for high performance street Chrysler small blocks. Can be used on 318 if 340-360ci cylinder heads are used. Will not fit 1992 and later Magnum engines.

Note: Not legal for sale or use on pollution controlled motor vehicles.

E5076 340-360 non-EGR natural finish 294.99 ea

413, 426, 440

Designed for street Chrysler big blocks that measure 8.75" across block. Will not fit 1962-64 Max Wedge heads.

Note: Not legal for sale or use on pollution controlled motor vehicles.

E5091 413-440 non-EGR natural finish 269.99 ea

Edelbrock OEM Replacement Multi-Carburetor Intakes



Edelbrock replacement multi-carburetor intakes feature an open air space that separates the runners from the hot engine oil for a cooler, denser air charge, resulting in more power.

Note: No further discounts apply.



E2475

Edelbrock CH-28 Dual Quad

413, 426, 440
Designed for Chrysler big blocks that measure 8.75" across block. Will not fit 1962-64 Max Wedge heads. Carb center to carb center: 6-7/16".

Note: Not legal for sale or use on pollution controlled motor vehicles.

E5440 413-440 non-EGR natural finish 371.99 ea

E54401 413-440 non-EGR polished finish 574.99 ea

Edelbrock CH-6B Six Pack

413, 426, 440
Designed for 440ci Chrysler engines with 3x2-bbl. carbs, also fits 413 and 426 Wedge. #E2475 is stock replacement/street legal part for 1968-71 model 440 V8s with OEM 3x2-bbl. carbs. This manifold was used on Chrysler 440 Six-Pack engines. Will not fit 1962-64 Max Wedge heads.

Note: 50-state legal.

E2475 413-440 natural finish 409.99 ea

E24751 413-440 polished finish 699.99 ea

1958-87 Edelbrock Intake Manifold Gaskets



Matched to Edelbrock Performer and Performer RPM cylinder heads and manifolds, Edelbrock intake gaskets allow for optimum flow and performance. The new MP-2N Micropore™ technology does not use solvents making our gaskets environmentally friendly. Impervious to leaded motor chemicals, this synthetic fiber composite provides a high recovery under load. This means that when compressed, the gasket will conform to any imperfections on the sealing surface even using lower flange pressures. A nitrile bead around each port opening makes the seal even better.

Note: *Must be used with OE style valve pan. No further discounts apply.

318, 340, 360ci

E7276 1966-87 intake manifold gaskets 19.99 pr

361, 383, 400, 413, 426 (exc. Hemi), 440ci

E7225* 1958-79 intake manifold gaskets 24.99 ea



Ignition Control Module

For use with Intake Manifold

#E7528 or #E75284.

Note: No further discounts apply.

E91239 5.7L Hemi 1089.99 ea



Intake Manifold Components

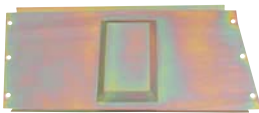

MN2420



Big Block Valve Pans with Dimple

These valve pans are designed for "RB" and "B" engines and include a clearance well, or dimple, that will clear exhaust crossovers found in many dual plane intake manifolds. "Lips" along the side fit underneath the edge of the cylinder heads, making a tight seal and allowing the use of standard intake port gaskets. This pan works well with the standard Edelbrock performer and Performer RPM intake. Works great with Edelbrock RPM cylinder heads and other aftermarket heads with an unbroken deck surface where the cylinder head meets the edge of the valve pan. These pans may be used with factory cylinder heads, depending on the intake manifold, if any break in the lower deck surface is filled with silicone. Finished in gold iridite finish for corrosion resistance. Made in USA.

Important: Will not work with original cast iron intake.

Note: Because this pan fits under intake face edges, at least one cylinder head must be removed in order to install or remove valve pan.

413, 426W, 440 Engines	
MN2420 RB engines.....	44.99 ea
361, 383, 400 Engines	
MN2422 B engines.....	44.99 ea



MN2419



Big Block Flat Valve Pans

These fabricated valve pans are designed for "RB" and "B" engines that are using single-plane intake manifolds. "Lips" along the sides fit underneath the edge of the cylinder heads, making a tight seal and allowing the use of standard intake port gaskets. Works great with Edelbrock RPM cylinder heads and other aftermarket heads with an unbroken deck surface where the cylinder head meets the edge of the valve pan. These pans may be used with factory cylinder heads, depending on the intake manifold, if any break in the lower deck surface is filled with silicone. Finished in gold iridite finish for corrosion resistance. Made in USA.

Important: Dual plane intake manifolds (both factory and aftermarket) will not fit due to exhaust manifold interference.

Note: Because this pan fits under intake face edges, at least one cylinder head must be removed in order to install or remove valve pan.

413, 426W, 440 Engines	
MN2419 RB engines.....	34.99 ea
361, 383, 400 Engines	
MN2421 B engines.....	34.99 ea



MN1094

1966-71 Intake Manifold Gasket Sets

Intake manifold gasket sets for 1966-71 big block and Hemi engines.	
MN1094 1966-71 Hemi, factory.....	16.99 set
MN1095 1966-71 383, 440.....	29.99 set



CLASSIC AUTHORIZED

1963-76 Temperature Sending Unit

The temperature sending unit screws into the side of the cylinder block or on the intake manifold and allows the temperature gauge or warning light to operate properly. Applications are available to fit most 1963-76 A-body, B-body and E-body vehicles with or without AC.

2426458 1968-76	with AC.....	8.99 ea
2426458 1963-76	without AC.....	8.99 ea



1966-71 Hemi Air Cleaner Breather Hose Kit

Reproduction air cleaner hose set for all Mopar A, B and E-Body models produced from 1966-71. Each kit features correct grooved hose and clamps and will fit and install on all black steel air cleaners. For black steel air cleaners.

MN1009 1966-71.....	19.99 kit
---------------------	-----------



MD2327

Date Coded Breather Hose

These hoses are date coded with correct lettering and color on quality Gates hose. Score more points at judging with products with an authentic appearance. Sold by the foot. 1 1/2" ID exactly as original.

MD2328 January 1969.....	14.99 ft
MD2327 January 1970.....	14.99 ft
MD2331 July 1968.....	14.99 ft
MD2332 July 1969.....	14.99 ft
MD2329 July 1970.....	14.99 ft
MD2330 July 1971.....	14.99 ft



MN1017

Universal Emission Duct Hose

Replacement aluminum flexible duct hose. This hose runs from the air cleaner snorkel to the exhaust manifold intake heater.

MN1017 2" ID x 18' L.....	5.99 ea
MN1018 1-3/4" ID x 18' L.....	19.99 ea

Intake Manifold Hardware Sets

Prevent intake manifold leaks with quality fasteners from ARP. They're rated at 170,000 psi and machined for optimum thread engagement. Wide overhead flanges and companion washers provide even load distribution while precision-rolled threads prevent galling and promote consistent torque loading for optimum sealing of gasket surfaces. Available in black oxide finished chrome moly or corrosion resistant stainless steel, as well as hex or 12-point heads. Washers included. Made in USA.



Small & Big Block Wedge Engines	
AR1437 black oxide hex head.....	34.99 set
AR1438 black oxide 12-point.....	36.99 set
AR1439 stainless hex head.....	54.99 set
AR1440 stainless 12-point.....	59.99 set

Air Cleaners



MN1013

1970-71 Six Pack Air Cleaner Assembly Kit

Low profile six pack air cleaner assembly. Each assembly includes metal base, lid, 2 studs, 2 nuts, 2 gaskets and lifetime manufacturer's warranty. They were designed specifically for 1970-71 B and E-Body models but may fit other applications.

MN1013 1970-71 non-cold air 444.99 ea
MN1145 1970 440 w/cold air 519.99 ea



MD2318

1969-72 Air Cleaner Lid

Metal air cleaner lid in correct orange for 1969-72 vehicles equipped with a 6-pack, Hemi or with the Grabber/Shaker hood option.

MD2318 1969-70 six pack 124.99 ea
MD2319 1969-72 Hemi oval 124.99 ea
MB6008 1969-72 Rd gr/shkr/4dbl 124.99 ea



MD7118

1969-71 Air Cleaner Baseplate

This baseplate sits directly on the carburetor. Available for 1969-71 Hemi 2x4-bbl engines and 1970-71 Challenger or 'Cuda models with shaker hoods and 340/383/440 4-bbl, Six Pack, 6-BBL, or Hemi 2x4-bbl engines.

Non-Shaker Hood Oval

MD7118 1969-71 426 Hemi, steel 749.99 ea

MD7119 1969-71 426 Hemi, fiberglass 179.99 ea

Shaker Hood

ME1621 1970-71 4dbl 340/383/440 749.99 ea

ME1622 1970-71 six pack 749.99 ea

ME1623 1970-71 Hemi Dual 4 859.99 ea



1968-69 Unsilenced Air Cleaner Assembly

Replacement unsilenced air cleaner assembly for 340, 383 and 440 4 bbl models. Includes both the top and base that are stamped steel and feature the correct finish.

MN1015 1968-69 340/383/440 4dbl 179.99 set



Mopar Performance Air Cleaner Set

Air cleaner assembly with "Mopar Performance" cast into the aluminum lid. Matches cast black Mopar Performance valve covers. 13-1/4" diameter. Includes lid, base, stem, wing nut and carb to air cleaner gasket. 3" element included.

MN1014 cast aluminum 109.99 set



T2195B

Chrome Air Cleaner

Chrome air cleaner 14" diameter, available with either 4" or 6" depth and features a 5-1/8" neck to fit most standard 4-BBL carburetors. Only fits 4-bbl carburetors. 1 year manufacturer's warranty.

Note: Not legal for sale or use in California on pollution controlled motor vehicles.

Air Cleaners

T2195B 14" x 4", 5-1/8" neck size 51.99 ea

T2286 14" x 6", 5-1/8" neck, low profile .. 44.99 ea

Replacement Filters

T2110 14" x 4" Fits T2195B 10.99 ea

T2287 14" x 6" Fits T2286 16.99 ea



E1223

Edelbrock Signature Series Air Cleaners

Top off your engine with a Pro-Flo air cleaner. The Edelbrock signature and styling go beautifully with Edelbrock Signature Series valve covers. Stamped from 18 gauge steel and triple chrome plated for a high quality finish and good looks. Fits all popular 5-1/8" diameter carburetor necks.

Important: Use E1121 with all Edelbrock square bore carburetors.

Note: No further discounts apply.

Round 14" Diameter w/3" Element

E1207 chrome w/logo 31.99 ea

E1121 chrome w/logo, low profile 29.99 ea

E1223 black w/logo, low profile 31.99 ea

Round 10" Diameter w/2" Element

E1208 chrome with logo 21.99 ea

E1203 black powdercoat w/logo 24.99 ea

Round 6" Diameter w/2" Element

E1209 with logo 29.99 ea

Triangular w/2-1/2" Washable Element

E1222 chrome with logo 101.99 ea



E4222

Edelbrock Elite Series Air Cleaners

Designed to match the Elite Series valve covers and breathers, all Elite series air cleaners have polished aluminum finned tops on a black matte background. Available with or without Edelbrock logo. All include a black anodized knurled nut and PCV adapter. For use on 5-1/8" carburetor necks.

Important: Use E4221 with all Edelbrock square bore carburetors.

Note: No further discounts apply.

Round 14" Diameter w/3" Element

E4207 with logo 79.99 ea

E4221 with logo 81.99 ea

Round 10" Diameter w/2" Element

E4210 with logo 69.99 ea

Triangular w/2-1/2" Washable Element

E4222 with logo 124.99 ea



AR801455

AIRaid Concept II Universal 14" Air Filter

AIRaid's Concept II filter features a beautiful lightweight aluminum lid that's perfect for user customization. The curved top enhances air flow and provides additional clearance for the carburetor foot bowl vents. Along with the re-designed lid, the Concept II also features a new base that enhances air flow. The new element features SynthMax material, a 100% synthetic, non-oiled, color fast, clean red media. Billet top & key bow included. Available in 3", 4" and 5" size.

AR801451 3" element 159.99 ea

AR801455 4" element 164.99 ea

AR801461 5" element 169.99 ea



SP98891

Spectre ProFab Low Profile Air Cleaner

Looking to add a high tech look to your engine compartment? Check out these Spectre ProFab low profile oval inlet polished air cleaners. Available in single, 90° dual, or 180° dual inlet styles. Fits all carburetors or TBI with 5-1/8" neck. Includes Spectre's HPR® air filter.

SP98801 single 201.99 ea

SP98891 90° dual 201.99 ea

Air Cleaner Parts

New!



Streamline Series Air Cleaners

These billet aluminum air cleaners are machined for style, featuring a mirror polished billet strip on top with integrated wing nut. Designed to fit standard four barrel carburetors, each air cleaner includes stainless steel hardware and detailed instructions. Choose from three designs, available in your choice of satin black powder coat or bead blasted and ready for paint. Made in USA.

Note: Not for use with Dominator carburetors. No further discounts apply.



158240	black 14" round	249.99 ea
158241	ready to finish 14" round	249.99 ea
154240	black large oval	199.99 ea
154241	ready to finish large oval	199.99 ea
153240	black small oval	179.99 ea
153241	ready to finish small oval	179.99 ea

New!



Ribbed Billet Air Cleaners

These precision machined air cleaners are a product of progression and styling. Manufactured from machined billet aluminum with a mirror polished finish, each air cleaner includes a K&N filter, stainless steel mounting hardware and detailed instructions. Available in a 14" round version or a dual quad configuration with adjustable base plate to allow for variations in carburetor spacing. Made in USA.

Note: Not for use with Dominator carburetors. No further discounts apply.



215840	14" round air cleaner	649.99 ea
215650	oval dual quad air cleaner	279.99 ea

New!

BOUCHILLON
Performance
Engineering



Six Pack Air Cleaner Element

This reproduction air cleaner element has been carefully reverse-engineered from Mopar originals and upgraded to modern standards. The correct color rubber is combined with an improved filter media for superior performance while galvanized stainless steel support screens offer an authentic appearance that won't corrode.

2946186		139.99 ea
---------	--	-----------

AUTHORITY
REPRODUCTION



MN1020

MN1025



MN1032

MN1027

Air Cleaner Pie Tins

Die-stamped aluminum "tins" that fit on top of the air cleaner lids of Hi-Po engines. Each tin features color logos for engine size and series name. Red logos were used through late 1968 and orange logos were used for most 1969 models and later.

1967-68 with Red Logo

MN1020	"340 Four Barrel"	71.99 ea
MN1030	"383 Commando"	71.99 ea
MN1021	"383 Four Barrel"	71.99 ea
MN1023	"383 Magnum"	71.99 ea
MN1025	"383 Roadrunner Engine"	71.99 ea
MN1032	"383 Super Commando"	71.99 ea
MN1025	"440 Magnum"	71.99 ea
MN1034	"440 Super Commando"	71.99 ea
MN1027	"440 T-N-T"	71.99 ea

1969-71 with Orange Logo

MN1019	"340 Four Barrel"	71.99 ea
MN1022	"383 Magnum"	71.99 ea
MN1028	"383 Roadrunner Engine"	71.99 ea
MN1031	"383 Super Commando"	71.99 ea
MN1024	"440 Magnum"	71.99 ea
MN1026	"440 T-N-T"	71.99 ea
MN1033	"440 Super Commando"	71.99 ea

New!

MORSO



Rubber Air Cleaner Base Gasket

This buna rubber air cleaner base gasket forms a positive seal between the air cleaner and the top of carburetors with a 5-1/8" neck. Designed for air cleaners with a straight lip, the gasket has a groove that fits over the lip for a superior seal against dust and debris. It can also be flipped and used on air cleaners with a rolled lip.

297331		6.99 ea
--------	--	---------

New!



E8093

Edelbrock

Edelbrock Air Cleaner Spacers

These 5-1/8" diameter plastic spacers from Edelbrock get you the clearance you need between the carburetor and air cleaner base. Available in 1/2" and 3/4" sizes. Made in USA.

Note: No further discounts apply.

E8093	1/2" tall spacer	14.99 ea
E8092	3/4" tall spacer	6.99 ea

SHOOTER
GREENS



ME1661



MB6001

T2174

MF227



MF230

MA2462

ME1663

Air Cleaner Fastener & Sealing Components

Fasteners and gaskets to seal factory engine air cleaners on various Mopar models.

Air Shroud Plate

Replacement of the steel plate that bolts onto the baseplate of AAR and T/A air cleaners.

ME1661	1970 AAR & T/A	17.99 ea
--------	----------------	----------

Air Cleaner Seals & Gaskets

Baseplate to Hood Seal		
MB6001	1969 A12 model	44.99 ea
Fiberglass Hood-to-Baseplate Seal		
MN1011	1970 AAR & T/A	119.99 ea
Shaker Baseplate Seal		
MN1012	1970-71 E-Body models	56.99 ea

Air Cleaner Stud & Wing Nut Sets

Each wing nut is 1/4"-20, 1 year manufacturer's warranty.

T2174	3" stud	1.99 set
T2178	4" stud	1.99 set
T2175	6" stud	1.99 set

OE Air Cleaner Stud

1962-74 Single 4-bbl Carburetor		
MN1005	1962-74 OEM, trim to fit	15.99 ea
Hemi w/ Carter Carburetor, A12 w/Lift-Off Hood		
MF227	1966-71 440 & Hemi	3.99 ea

Models w/Carter AVS Carburetor

MF223	1968-71 1/4"-20 x 5" long	3.99 ea
1970-74 340 & 440 Six Pack		
MF229	1970-74 1/4"-20	8.99 ea

Reproduction Wing Nut

The correct reproduction wing nut for all 1/4" stud carburetor applications. Zinc plated for a lasting shine.

MF230	1/4" zinc plated wing nut	2.99 ea
-------	---------------------------	---------

A-Body Hood Scoop To Filter Seals

Round rubber hood seals that connect filter to scoop on cars with scoop style hoods, 4" diameter.

MA2462	1970-71 hood scoop seals	74.99 pr
--------	--------------------------	----------

Shaker Baseplate Nut washer Set

Replacement of the diamond shaped metal washers which mount the center baseplate to the outer adapter ring.

ME1663	1970-71 set of 7	35.99 set
--------	------------------	-----------

Performance Air Cleaner Parts



858913CBK



858913CRD



858913COR

K&N Carburetor Cover

Damage to pistons, rings and other components can be caused by accidentally dropping something into your carb while the air cleaner assembly is off. The K&N Carburetor Cover is used on 5-1/8" carburetors eliminating the risk of dropping bolts, nuts, screws or other items down the throat and into the intake manifold. Also works well in keeping dirt, dust and other elements out of your carb during times you must store your engine or vehicle with the air cleaner assembly removed. Choose from black, red or orange. **5-1/8" Carburetor Cover**
858913C (specify black, red or orange) ... 31.99 ea



253750-custom fit



253900-universal fit

K&N Airforce Pre-Cleaner

The K&N Airforce Pre-Cleaner is a specially designed foam filter wrap made to extend the service interval of your K&N Air Filter. It is especially helpful when operating in very dusty conditions such as off-road or in construction sites. Manufactured from large open cell foam, the Airforce Pre-Cleaners are available as a custom fit application for 14" round elements or as a universal "cut to fit" application. "Cut to fit" applications come with velcro straps to secure the foam to your air cleaner.

14" Diameter Custom Fit Airforce Pre-Cleaners	
253750 with 4" high element.....	25.99 ea
253760 with 5" high element.....	29.99 ea
253770 with 6" high element.....	32.99 ea
Universal "Cut To Fit" Airforce Pre-Cleaners	
253900 7" high x 48" long.....	24.99 ea
253918 18" high x 48" long.....	51.99 ea
253924 24" high x 48" long.....	61.99 ea
253930 30" high x 48" long.....	76.99 ea



Air Filter Sealing Grease

K&N Air Filter Sealing Grease seals the air cleaner assembly, eliminating the possibility of dirt, dust and other particles from entering your carburetor from between the air filter element and air cleaner assembly. This is especially important if you will be operating your vehicle off road or in extremely dusty conditions such as construction sites, etc. K&N Air Filter Sealing Grease resists heat and will not melt or run off. Choose from 6 ounce or 1 ounce squeeze tube.
990704 6 ounce tube..... 9.99 ea

New!



CL8500

Retro Style Air Cleaner

This custom air cleaner assembly was inspired by the Cadillac and Oldsmobile oil bath air cleaners of the early 1950s. Manufactured in heavy gauge steel and powdercoated in a semi-gloss black finish, these custom air cleaners fit most carburetors and throttle bodies with a 5-1/8" mounting flange. The lower rear section of the air cleaner is clearcoated for HEI distributors. Available in a full scale 18-1/4" wide version that uses a 14" x 4" filter element and a 7/8 scale 15-21/32" wide version that uses a 12" x 3" filter element. Both sizes include a filter element, chrome rocket-shaped wing nut and an air cleaner decal.

CL8510 7/8 scale 15-21/32" wide.....	129.99 ea
CL8500 full scale 18-1/4" wide.....	129.99 ea

New!



52331

Full Sized Street Scoops

These full sized aluminum street scoops add an aggressive performance look to any custom street or show car engine. These finned and polished scoops measure 20" long by 5" tall and are available for both dual or single quad applications, fitting carburetors with a 5-1/8" neck. Scoops include all necessary mounting hardware and 6-3/8" x 2-1/2" paper element air filters.
52351 single quad scoop..... 168.99 ea
52331 dual quad scoop..... 163.99 ea

New!



52451

52461

Mini Street Scoops

Give any engine the look of sheer horsepower with these beautiful aluminum mini street scoops. Designed for single quad carburetors with a 5-1/8" neck. These aluminum scoops measure 13-1/2" long and 4-1/2" tall, and are available with finned or smooth polished finishes. Ready to bolt on with all necessary hardware and a 6-3/8" x 2-1/2" paper element air filter.
52451 smooth scoop..... 114.99 ea
52461 finned scoop..... 124.99 ea

New!



SP98303A



SP98302A

Spectre ProFab Cowl Induction Air Cleaner

These Spectre ProFab aluminum cowl induction air cleaners are designed to fit cowl induction hoods. Draws air from the high pressure area at the base of the windshield. Available in round, straight back opening or sidewinder design. Fits all carburetors or TBI with 5-1/8" neck. Includes Spectre's HPR air filter.

Straight Back Style

SP98303A 3" tall filter	4.219" height	254.99 ea
SP98424A 4" tall filter	5.219" height	275.99 ea
SP98524A 5" tall filter	6.219" height	291.99 ea

Round Style

SP98302A 3" tall filter	4.219" height	201.99 ea
SP98421A 4" tall filter	5.219" height	224.99 ea
SP98521A 5" tall filter	6.219" height	244.99 ea

New!



53391



52391

Aluminum Street Scoops

These aluminum street scoops add an old-school performance look to almost any engine, especially if it has a tunnel ram or dual carburetors. Each 20" scoop is made from polished cast aluminum with three fully-functional reversible round butterflys. Designed for carburetors with a 5-1/8" neck and comes with both dual and single carburetor mounting plates, 6-3/8" x 2-1/2" paper element air filters, hardware and instructions.
53391 smooth housing scoop set..... 263.99 ea
52391 ribbed housing scoop set..... 257.99 ea

K&N PERFORMANCE FILTERS



E1650

K&N Air Cleaner Assemblies

Using oil-impregnated pleated cotton, K&N filter elements exceed minimum filtration standards while creating little restriction to air flow. This results in more air going into the engine and more power being produced. These filters are washable, reusable, and backed by a one million mile limited warranty. The elements listed below are designed for use with K&N chrome and stainless steel air cleaner assemblies.

14" Round Elements

E1650	3" height, 14" diameter	49.99 ea
E3750	4" height, 14" diameter	62.99 ea
E3760	5" height, 14" diameter	71.99 ea
E3770	6" height, 14" diameter	81.99 ea

11" Round Elements

KE1200	2-1/8" height, 11" diameter	59.99 ea
E1250	5-1/2" height, 11" diameter	66.99 ea
E3680	5" height, 11" diameter	64.99 ea
E3690	6" height, 11" diameter	67.99 ea

14" Triangular Element

E3737	3" height, 14" triangular	64.99 ea
-------	---------------------------	----------



601290

K&N 14" Low Profile Chrome Air Cleaner

These air cleaners provide a low profile by dropping the filter 7/8" or 1-1/4" below the carburetor flange. 5-1/8" flange fits all popular 4-barrel carburetors. Your choice of 4 element heights are offered to fit a wide variety of applications. The 7/8" drop will fit carburetors with electric choke mechanisms. Optional vent kit, item # 851190 is available and sold separately. Total height listed below is the minimum clearance needed above the carburetor flange.

*Note: *Items marked with asterisk will not fit Edelbrock carburetors with electric choke.*

7/8" Drop Complete Assembly, without Vent Kit

601430	3" element, 3.12" total height...	111.99 ea
601440	4" element, 4.12" total height...	114.99 ea
601450	5" element, 5.12" total height...	124.99 ea
601460	6" element, 6.12" total height...	124.99 ea
601280	3" element, 2.75" total height...	101.99 ea
601290	4" element, 3.75" total height...	129.99 ea
601300	5" element, 4.75" total height...	121.99 ea
601310*	6" element, 5.75" total height...	119.99 ea



K&N 14" Triangular Chrome Air Cleaner

Breathe a little life into your engine compartment! This triangular air cleaner will set your underhood area apart from the norm. The 5-1/8" flange fits all popular 4-barrel carburetors. Element height is 3" while 3.62" is the minimum clearance needed above the carburetor flange.

14" Triangular Complete Assembly, with Vent Kit
601470 3" element, 3.62" total height... 129.99 ea



601260

14" Raised Profile Chrome Air Cleaner

This air cleaner raises the element 9/16" above the carburetor flange. 5-1/8" flange fits all popular 4-barrel carburetors. Your choice of 4 element heights are offered to fit a wide variety of applications. Will clear HEI distributors. Vent kit is included. Total height listed below is the minimum clearance needed above the carburetor flange.

9/16" Raised Profile Complete Assembly, w/vent kit

601263	2-1/4" element, 3.87" total ht...	114.99 ea
601264	3" element, 4.62" total height...	109.99 ea
601260	4" element, 5.62" total height...	139.99 ea
601270	5" element, 6.62" total height...	139.99 ea



601180

K&N 11" Stainless Steel Air Cleaner

This air cleaner is perfect when high performance is desired but space is at a premium. 5-1/8" flange fits all popular 4-barrel carburetors. Your choice of 4 element heights are offered to fit a wide variety of applications. 3/4" vent kit is included. Total height listed below is the minimum clearance needed above the carburetor flange. Top is made of long lasting polished stainless steel while bottom is an attractive chrome finish.

11" Diameter Complete Assembly, with Vent Kit

601170	2-1/8" element, 3.12" total ht...	131.99 ea
601180	3-1/2" element, 4.75" total ht...	111.99 ea
601200	5" element, 6.00" total height...	119.99 ea
601210	6" element, 7.00" total height...	119.99 ea



13971

13973

Custom Air Cleaner Assemblies

You've got billet spokes on your wheels, now get precision machined billet spokes in your engine compartment! K&N, renowned for superior performance, durability, and styling in their filters, combines serious air flow with gorgeous looks in these round, 14" billet aluminum air cleaners with either a 5 spoke or 10 spoke lid. Both styles include a carbon fiber insert and a 3" tall K&N element. They are designed to fit 5-1/8" carburetor flanges, and are available with either a 1-1/4" drop base or a standard 9/16" raised base.
13971 5 spoke w/1-1/4" drop base... 269.99 ea
13972 5 spoke w/9/16" raised base... 269.99 ea
13973 10 spoke w/1-1/4" drop base... 269.99 ea
13974 10 spoke w/9/16" raised base... 269.99 ea
13975 5 spoke lid only... 164.99 ea
13976 10 spoke lid only... 164.99 ea



663060



661401

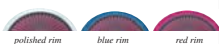

polished rim

blue rim

red rim

XStream Air Flow Top and Assembly

If your engine still has its stock style filter element and air cleaner assembly, it is probably not realizing its full horsepower potential. Restrictive elements and turbulence inside a stock filter housing can choke critical airflow. K&N's XStream® Air Flow Top or the XStream® Air Flow Assembly for 5-1/8" neck flange. Choose from the complete assembly or just add the top to your existing round filter. Either way, you'll enjoy the benefits of a high flow element that cuts turbulence. Cleanable and reusable just like our other filters. Height listed below is minimum clearance needed above the carburetor flange.

Top Only

661401	14" diameter black rim	69.99 ea
661401XP	14" diameter polished rim	79.99 ea
661401XB	14" blue rim	79.99 ea
661401XR	14" red rim	79.99 ea

Assembly 7/8" Drop

663050	3" element - 3-1/8" height	169.99 ea
--------	----------------------------	-----------

Assembly 1-1/4" Drop

663040	3" element - 2-3/4" height	139.99 ea
663060	4" element - 3-3/4" height	149.99 ea
663070	5" element - 4-3/4" height	179.99 ea

Assembly Raised 9/16" Base

663010	3" element - 4-5/8" height	149.99 ea
663020	4" element - 5-7/8" height	184.99 ea
663030	5" element - 6-7/8" height	191.99 ea

K&N Air Filter Oil & Clean/Degreaser Kit!

K&N Air Filter Oil and Cleaner/Degreaser is the only oil and cleaner/degreaser specially formulated to work in combination with the cotton fabric in the K&N filter. The use of any other could void the filter's warranty and potentially harm the air filter's cotton material. The cleaner/degreaser works to dissolve the dirt build up and old oil filter oil and can be washed away with water. It is environmentally friendly, and when used as directed, is safe on paint, chrome, cast aluminum, plastic, rubber and vinyl. Each kit includes oil, cleaner/degreaser, and service decal. Your choice of 6-1/2 oz. aerosol spray or 8 oz. squeeze oil bottle is offered.



995000	kit w/6-1/2 oz. aerosol oil	11.99 set
995010	kit with 8 oz. squeeze oil	11.99 set



Performance Intakes



Universal 14" or 16" Air Boxes

Direct cool air into your engine with these universal air boxes. Includes components and hardware for installation in most vehicles. 180°, 150°, 135°, and 120° versions are available. Choose from 14" or 16" housing with either black or chrome ducting. Fits standard 5-1/8" carb neck.

14" Universal Air Box			
SP70228A	black duct	180°	152.99 ea
SP70228B	chrome duct	180°	229.99 ea
SP70318A	black duct	150°	152.99 ea
SP70318B	chrome duct	150°	229.99 ea
SP70328A	black duct	135°	152.99 ea
SP70328B	chrome duct	135°	229.99 ea
SP70338A	black duct	120°	152.99 ea
SP70338B	chrome duct	120°	229.99 ea
16" Universal Air Box			
SP70168A	black duct	180°	201.99 ea
SP70168B	chrome duct	180°	229.99 ea
SP70188A	black duct	150°	249.99 ea
SP70188B	chrome duct	150°	279.99 ea
SP70138A	black duct	135°	249.99 ea
SP70138B	chrome duct	135°	279.99 ea
SP70118A	black duct	120°	201.99 ea
SP70118B	chrome duct	120°	229.99 ea



Universal Dual Plenum Air Intakes

These air intake systems use a dual plenum design available with two 45° intake tubes or two 6" straight tubes both with two filters to get the most power from your engine! Includes intake tubes, filters, boots, clamps, and hardware. Choose from blue, black, red, or white filters. Fits standard 5-1/8" carb neck.

Note: *Requires 3-1/2" clearance between the top of the carburetor and the hood. **Requires 3-3/4" clearance between the top of the carburetor and the hood.

45° tubes			
SP70761A*	blue filters	199.99 ea	
SP70761B*	black filters	199.99 ea	
SP70761C*	red filters	199.99 ea	
SP70761D*	white filters	199.99 ea	
6" straight through tubes			
SP70796A**	blue filters	199.99 ea	
SP70796B**	black filters	199.99 ea	
SP70796C**	red filters	199.99 ea	
SP70796D**	white filters	199.99 ea	



Universal Low Profile Dual Plenum Air Intakes

Get the most power from your engine with these sheet metal aluminum plenum design, offering extremely low profile dimensions for tight hood clearance applications. Available with two 45° tubes or two 45° 90° tubes. Fits all carburetors and TBI throttle bodies with 5-1/8" neck. Includes intake tubes, filters, boots, clamps, and hardware. Choose from blue, black, red, or white filters.

Note: *Requires 2-1/2" clearance between the top of the carburetor and the hood. **Requires 2" clearance between the top of the carburetor and the hood.

Dual Plenum Air Intakes	
SP70771A*	blue filters..... 249.99 ea
SP70771B*	black filters..... 249.99 ea
SP70771C*	red filters..... 249.99 ea
SP70771D*	white filters..... 249.99 ea

Dual Plenum Sheet Metal Intakes	
Intake with Two 45° 90° tubes	
SP70764A**	blue filters..... 269.99 ea
SP70764B**	black filters..... 269.99 ea
SP70764C**	red filters..... 269.99 ea
SP70764D**	white filters..... 269.99 ea
Intake with Two 45° Tubes	
SP70778A**	blue filters..... 229.99 ea
SP70778B**	black filters..... 229.99 ea
SP70778C**	red filters..... 229.99 ea
SP70778D**	white filters..... 229.99 ea



Extraflow 14" Air Cleaners

These muscle car air cleaners combine a modern appearance with the classic style of the past. Washable and reusable, these lifetime filters provide more power and performance by allowing more air flow into your engine than ordinary paper filters. Includes the top, base, and Spectre HPR® air filter in your choice of red, blue, black or white.

3" Tall Filter	
SP74762A	blue..... 101.99 ea
SP74762B	black..... 101.99 ea
SP74762C	red..... 101.99 ea
SP74762D	white..... 101.99 ea

4" Tall Filter	
SP74763A	blue..... 119.99 ea
SP74763B	black..... 122.99 ea
SP74763C	red..... 122.99 ea
SP74763D	white..... 122.99 ea

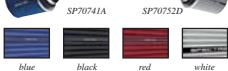

Universal 90°/45° Single Plenum Air Intake

This air intake system uses a single plenum design with 45° 90° tube to get the most power from your engine! Available for driver or passenger side in standard height or low profile configuration. Includes intake tubes, filters, boots, clamps, and hardware. Choose from blue, black, red, or white filters. Fits standard 5-1/8" carb neck.

Note: Standard height air intakes require 3-1/2" clearance between the top of the carburetor and the hood. Low-profile air intakes require 2-1/2" clearance between the top of the carburetor and the hood.

Standard Height Air Intakes	
SP70742A	blue filter LH..... 149.99 ea
SP70742B	black filter LH..... 149.99 ea
SP70742C	red filter LH..... 149.99 ea
SP70742D	white filter LH..... 149.99 ea
SP70741A	blue filter RH..... 149.99 ea
SP70741B	black filter RH..... 149.99 ea
SP70741C	red filter RH..... 149.99 ea
SP70741D	white filter RH..... 149.99 ea

Low-Profile Air Intakes	
SP70752A	blue filter LH..... 149.99 ea
SP70752B	black filter LH..... 149.99 ea
SP70752C	red filter LH..... 149.99 ea
SP70752D	white filter LH..... 149.99 ea
SP70751A	blue filter RH..... 149.99 ea
SP70751B	black filter RH..... 149.99 ea
SP70751C	red filter RH..... 149.99 ea
SP70751D	white filter RH..... 149.99 ea



Performance Intakes



SP70757C

SP70747B



SP70793C



SP70748A



Universal Single Plenum Air Intakes

These air intake systems use a single plenum design with 90° tube to get the most power from your engine! Available in standard height or low profile configuration. Includes intake tubes, filters, boots, clamps, and hardware. Choose from blue, black, red, or white filters. Fits standard 5-1/8" carb neck.

Note: Standard height air intakes require 2-1/2" clearance between the top of the carburetor and the hood. Low-profile air intakes require 2-1/2" clearance between the top of the carburetor and the hood.

Standard Height - 90° Tube

SP70747A	blue filter.....	149.99 ea
SP70747B	black filter.....	149.99 ea
SP70747C	red filter.....	149.99 ea
SP70747D	white filter.....	149.99 ea

Low Profile - 90° Tube

SP70757A	blue filter.....	149.99 ea
SP70757B	black filter.....	149.99 ea
SP70757C	red filter.....	149.99 ea
SP70757D	white filter.....	149.99 ea

Standard Height - Y-Tube

SP70748A	blue filters.....	199.99 ea
SP70748B	black filters.....	199.99 ea
SP70748C	red filters.....	199.99 ea
SP70748D	white filters.....	199.99 ea

Low Profile - Y-Tube

SP70758A	blue filters.....	199.99 ea
SP70758B	black filters.....	199.99 ea
SP70758C	red filters.....	199.99 ea
SP70758D	white filters.....	199.99 ea

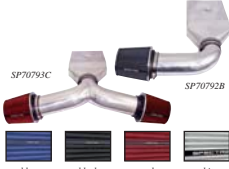

SP70793C

SP70792B



Universal DTM Plenum Air Intakes

These air intake systems use a DTM (Down The Middle) plenum design with either a 90° or Y-tube to get the most power from your engine! Includes intake tubes, filters, boots, clamps, and hardware. Choose from blue, black, red, or white filters. Fits standard 5-1/8" carb neck.

Note: Each DTM intake requires 2-1/4" clearance between the top of the carburetor and the hood.

90° Tube

SP70792A	blue filter.....	299.99 ea
SP70792B	black filter.....	299.99 ea
SP70792C	red filter.....	299.99 ea
SP70792D	white filter.....	299.99 ea

Y-Tube

SP70793A	blue filter.....	339.99 ea
SP70793B	black filter.....	339.99 ea
SP70793C	red filter.....	339.99 ea
SP70793D	white filter.....	339.99 ea

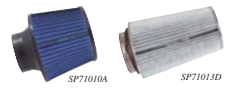

SP71010A

SP71013D



Spectre HPR® Cone Air Filters

These Spectre HPR® air filters are the most versatile of their kind on the market! Designed to fit 3", 3-1/2", and 4" tubes. Washable and reusable, these lifetime filters provide more power and performance by allowing more air flow into your engine than ordinary paper filters.

*Note: *Will only fit 3" inlet tubes. Also features all-rubber construction, no chrome finish.*

3.7" Tall Filter

SP71011A	blue.....	19.99 ea
SP71011B	black.....	19.99 ea
SP71011C	red.....	19.99 ea
SP71011D	white.....	19.99 ea

6.5" Tall Filter

SP71010A*	blue.....	19.99 ea
SP71010B*	black.....	19.99 ea
SP71010C*	red.....	19.99 ea
SP71010D*	white.....	19.99 ea

6.7" Tall Filter

SP71012A	blue.....	29.99 ea
SP71012B	black.....	29.99 ea
SP71012C	red.....	29.99 ea
SP71012D	white.....	29.99 ea

10.5" Tall Filter

SP71013A	blue.....	39.99 ea
SP71013B	black.....	39.99 ea
SP71013C	red.....	39.99 ea
SP71013D	white.....	39.99 ea



SP71014A

SP71015B

SP71017B

SP71018A



Spectre HPR® Air Filters

Speed By Spectre HPR® (high performance racing) air filters - the world's fastest air filters! Washable and reusable, these lifetime filters are designed to provide you with more horsepower and quicker acceleration by allowing more air flow into your engine than ordinary paper filters.

Round Filter - 14" x 4"

SP71014A	blue.....	39.99 ea
SP71014B	black.....	39.99 ea
SP71014C	red.....	39.99 ea
SP71014D	white.....	39.99 ea

Round Filter - 14" x 5"

SP71015A	blue.....	59.99 ea
SP71015B	black.....	59.99 ea
SP71015C	red.....	59.99 ea
SP71015D	white.....	59.99 ea

Oval Filter - 11-1/2" x 8" x 2"

SP71016A	blue.....	29.99 ea
SP71016B	black.....	29.99 ea
SP71016C	red.....	29.99 ea
SP71016D	white.....	29.99 ea

Oval Filter - 15" x 8" x 2"

SP71017A	blue.....	39.99 ea
SP71017B	black.....	39.99 ea
SP71017C	red.....	39.99 ea
SP71017D	white.....	39.99 ea

Triangle Filter - 14" x 3"

SP71018A	blue.....	49.99 ea
SP71018B	black.....	49.99 ea
SP71018C	red.....	49.99 ea
SP71018D	white.....	49.99 ea

Spectre Accucharge

Precision Air Filter

Oiling System

The Accucharge precision oiling system applies the correct amount of oil for optimum performance - no more, no less. Designed specifically for cleaning and oiling of Spectre HPR® filters. As simple to use as a measuring cup! Includes 12 oz. of cleaner and 8 oz. of oil.



11.99 ea

These Custom Billet Air Cleaners Go Beyond Engine Dress-Up Take Your Mopar Engine to a New Level of Excellence!



Air Cleaner Bases
CNC-machined to fit snugly onto standard 5-1/8" carburetor necks. Available for single 4 bbl and 2 x 4 bbl Holley and Edelbrock carburetors. Will not warp with heat!

Available in Satin or Polished Finish!

Air Cleaner Lids
Lids are CNC-machined from a 30 pound block of billet aluminum.



Custom Hold-Downs
These brackets fasten from the underside of the air cleaner, leaving the topside clear and uncluttered.

Washable Filter Elements
Choose from orange or white cotton filter elements, available in 2" height to fit most vehicles or 3" for applications with extra hood clearance.



plain style lid



ribbed style lid



engraved 1" style lid



embossed style lid

Choose Your Custom Air Cleaner in Four Easy Steps:

Simply choose an air cleaner lid size, finish and design, a filter element height and color, a base for your application, and finally the correct hold-down set to obtain that custom billet look!



1 Choose Your Lid Size & Design

1" x 15" Billet Air Cleaner Lids

Satin Finish			
MN2811	1960-76	plain	429.99 ea
MN2813	1960-76	ribbed	429.99 ea
MN2815	1960-76	embossed Hemi	429.99 ea
MN2825	1960-76	engraved 572 Hemi	429.99 ea
MN2823	1960-76	engraved 540 Hemi	429.99 ea
MN2821	1960-76	engraved 528 Hemi	429.99 ea
MN2819	1960-76	engraved 500 Hemi	429.99 ea
MN2817	1960-76	engraved 426 Hemi	429.99 ea

Polished Finish			
MN2812	1960-76	plain	529.99 ea
MN2814	1960-76	ribbed	529.99 ea
MN2816	1960-76	embossed Hemi	529.99 ea
MN2826	1960-76	engraved 572 Hemi	529.99 ea
MN2824	1960-76	engraved 540 Hemi	529.99 ea
MN2822	1960-76	engraved 528 Hemi	529.99 ea
MN2820	1960-76	engraved 500 Hemi	529.99 ea
MN2818	1960-76	engraved 426 Hemi	529.99 ea

2" x 15" Billet Air Cleaner Lids

Satin Finish			
MN2844	1960-76	426 Hemi 500 hp	789.99 ea
MN2846	1960-76	500 Hemi 550 hp	789.99 ea
MN2848	1960-76	528 Hemi 650 hp	789.99 ea
MN2845	1960-76	540 Hemi 800 hp	789.99 ea
MN2852	1960-76	572 Hemi 875 hp	789.99 ea
Polished Finish			
MN2845	1960-76	426 Hemi 500 hp	929.99 ea
MN2847	1960-76	500 Hemi 550 hp	929.99 ea
MN2849	1960-76	528 Hemi 650 hp	929.99 ea
MN2851	1960-76	540 Hemi 800 hp	929.99 ea
MN2853	1960-76	572 Hemi 875 hp	929.99 ea

1" x 20" Billet Air Cleaner Lids

Satin Finish			
MN2780	1966-76	plain	429.99 ea
MN2782	1966-76	ribbed	429.99 ea
MN2784	1966-76	embossed Hemi	429.99 ea
MN2794	1966-76	engraved 572 Hemi	429.99 ea
MN2792	1966-76	engraved 540 Hemi	429.99 ea
MN2790	1966-76	engraved 528 Hemi	429.99 ea
MN2788	1966-76	engraved 500 Hemi	429.99 ea
MN2786	1966-76	engraved 426 Hemi	429.99 ea

Polished Finish			
MN2781	1966-76	plain	529.99 ea
MN2783	1966-76	ribbed	529.99 ea
MN2785	1966-76	embossed Hemi	529.99 ea
MN2795	1966-76	engraved 572 Hemi	529.99 ea
MN2793	1966-76	engraved 540 Hemi	529.99 ea
MN2791	1966-76	engraved 528 Hemi	529.99 ea
MN2789	1966-76	engraved 500 Hemi	529.99 ea
MN2787	1966-76	engraved 426 Hemi	529.99 ea

2" x 20" Billet Air Cleaner Lids

Satin Finish			
MN2834	1966-76	426 Hemi 500 hp	789.99 ea
MN2836	1966-76	500 Hemi 550 hp	789.99 ea
MN2838	1966-76	528 Hemi 650 hp	789.99 ea
MN2840	1966-76	540 Hemi 800 hp	789.99 ea
MN2842	1966-76	572 Hemi 875 hp	789.99 ea
Polished Finish			
MN2835	1966-76	426 Hemi 500 hp	929.99 ea
MN2837	1966-76	500 Hemi 550 hp	929.99 ea
MN2839	1966-76	528 Hemi 650 hp	929.99 ea
MN2841	1966-76	540 Hemi 800 hp	929.99 ea
MN2843	1966-76	572 Hemi 875 hp	929.99 ea

2 Choose Your Filter Element

These washable and reusable cotton filter elements are available in 15" and 20" configurations. The 2" versions fit most vehicles, while the 3" version will provide better air flow for those with additional hood clearance. Choose from the standard filter or the lifetime version with its extra dense cotton material in your choice of orange or white.

15" Elements

Standard			
MN2497	1960-76	2" white	55.99 ea
MN2805	1960-76	2" orange	71.99 ea
MN2807	1960-76	3" white	91.99 ea
MN2809	1960-76	3" orange	105.99 ea
Lifetime			
MN2804	1960-76	2" white	119.99 ea
MN2806	1960-76	2" orange	125.99 ea
MN2808	1960-76	3" white	119.99 ea
MN2810	1960-76	3" orange	125.99 ea

20" Elements

Standard			
MN2498	1966-76	2" white	55.99 ea
MN2774	1966-76	2" orange	71.99 ea
MN2776	1966-76	3" white	91.99 ea
MN2778	1966-76	3" orange	105.99 ea
Lifetime			
MN2773	1966-76	2" white	119.99 ea
MN2775	1966-76	2" orange	125.99 ea
MN2777	1966-76	3" white	119.99 ea
MN2779	1966-76	3" orange	125.99 ea



single 4 bbl carburetor base

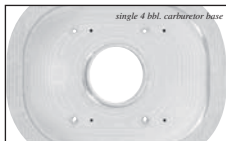

engraved 2" style lid



3 Choose Your Air Cleaner Base

15" Aluminum Bases

Satin Finish

MN2796	1960-76	1 x 4 bbl Holley.....	429.99 ea
MN2872	1960-76	1 x 4 bbl Edelbrock.....	429.99 ea
MN2798	1960-76	2 x 4 bbl Holley.....	429.99 ea
MN2800	1960-76	2 x 4 bbl Edelbrock.....	429.99 ea

Polished Finish

MN2797	1960-76	1 x 4 bbl Holley.....	529.99 ea
MN2873	1960-76	1 x 4 bbl Edelbrock.....	529.99 ea
MN2799	1960-76	2 x 4 bbl Holley.....	529.99 ea
MN2801	1960-76	2 x 4 bbl Edelbrock.....	529.99 ea

20" Aluminum Bases

Satin Finish

MN2765	1966-76	1 x 4 bbl Holley.....	429.99 ea
MN2874	1966-76	1 x 4 bbl Edelbrock.....	429.99 ea
MN2767	1966-76	2 x 4 bbl Holley.....	429.99 ea
MN2769	1966-76	2 x 4 bbl Edelbrock.....	429.99 ea

Polished Finish

MN2766	1966-76	1 x 4 bbl Holley.....	529.99 ea
MN2875	1966-76	1 x 4 bbl Edelbrock.....	529.99 ea
MN2768	1966-76	2 x 4 bbl Holley.....	529.99 ea
MN2770	1966-76	2 x 4 bbl Edelbrock.....	529.99 ea

4 Choose Your Hold-Down Set

Required to install your custom air cleaner. Choose the version 15" or 20" version. Includes bolts. Made from T-6 aluminum. Made in the USA.

MN2802	1960-76	15" air cleaner	101.99 set
MN2771	1960-76	20" air cleaner	101.99 set

Finish Off The Custom Billet Look in your Engine Bay!



MN2761



MN2478

426 Hemi Aluminum Intake Manifolds

These aluminum intake manifolds for 426 Hemi are an upgrade for the original versions offered by Mopar. Available in single or dual 4 bbl configuration for Holley or Edelbrock carburetors. Made in the USA.

Note: Fits OEM style stock street Hemi.

MN2761	1964-71	1 x 4 bbl Holley.....	719.99 ea
MN2478	1964-71	2 x 4 bbl Edelbrock.....	719.99 ea
MN2763	1964-71	2 x 4 bbl Holley.....	719.99 ea
MN2764	1964-71	2 x 4 bbl Edelbrock.....	719.99 ea

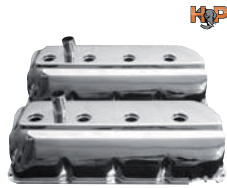

MN2475



MN2476

426 Hemi Stamped Steel Valve Covers

These steel 426 Hemi valve covers are replicas of the original and are offered in chrome or a black wrinkle finish.

MN2475	1964-72	chrome.....	299.99 pr
MN2476	1964-72	black wrinkle finish.....	419.99 pr



MN2757

426 Hemi Cast Aluminum Valve Covers

These finned cast aluminum valve covers are taller than original, providing clearance for roller rockers. Includes breathers, one of which doubles as an oil fill location. Offered in powder coated or plain cast form.

Made in the USA.

MN2754	1964-71	as cast.....	799.99 pr
MN2755	1964-71	polished.....	829.99 pr
MN2756	1964-71	satin machined.....	829.99 pr
MN2757	1964-71	powder coated.....	829.99 pr



MN2499

Big Block & 426 Hemi Custom Billet Aluminum Timing Chain Cover

These solid billet aluminum timing chain covers provide a unique custom appearance. Available with a removable plate to allow timing chain inspection or as a solid cover. Fits 383 ci, 400 ci, 426 ci (including Hemi), and 440 ci engines. Made in the USA.

MN2499	1964-72	w/inspection plate ...	224.99 ea
MN2432	1964-72	w/o inspection plate ...	189.99 ea



MN2502

Big Block and Hemi Cast Aluminum Oil Pans

High capacity oil pans for big block 426 Hemi engines fit flush with most frames and provide maximum ground clearance. Features functional cooling fins. Offered as cast or with a polished finish in 7 or 8 quart capacities. Oil pickup included. Made in the USA.

MN2500	1964-72	7 quart as cast.....	301.99 ea
MN2501	1964-72	7 quart polished.....	445.99 ea
MN2502	1964-72	8 quart as cast.....	445.99 ea
MN2503	1964-72	8 quart polished.....	589.99 ea

Replacement Oil Pans



MD1653



MD2333

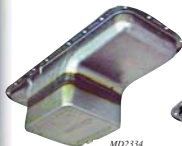

MD2334



MD7100

1964-74 Small & Big-Block Oil Pans

1964-74 Oil Pans

Aftermarket heavy steel unpainted and chrome-plated oil pans. Each pan includes drain plug. Gasket sold separately.

Small Block 273-318-340

MD1653 1964-72 stock style..... 49.99 ea

Big Block 383-440-426

MD2333 1964-72 stock style..... 79.99 ea

MD2334 1966-74 7-quart..... 104.99 ea

1966-71 B-Body & E-Body "402" 5-Quart Big Block Oil Pan

Replacement "402" oil pan for all big block 1966-71 B-Body and 1970-71 E-Body 383 applications. Made from heavy gauge steel, each pan features both baffles and all the details of the original. Comes with drain plug and washer.

MD7100 1966-71 B-Body & E-Body..... 179.99 ea



MD7101



MD7103



MD7104

1966-76 Hamburger's High Capacity Oil Pans

Hamburger's "Street Performance" steel oil pans feature increased oil capacity for improved bearing life and engine durability with the added benefit of lower oil temperatures. Includes: magnetic drain plug with brass washer and has a high gloss red painted finish. Oil pan has a 7" center deep sump, 7 quart capacity including oil filter, can use a stock oil pump. Does not include: oil pick up tube or oil pan gasket. Fits 1966 and later B and RB Chrysler engines in most production chassis.

Note: Does not fit 1962-65 production chassis.

Oil Pan

MD7101 1966-76 361-440 and 426 Hemi..... 194.99 ea

Pick up Tubes

MD7107 1966-76 361-440..... 29.99 ea

MD7103 1966-72 426 Hemi..... 29.99 ea

Oil Pan Gasket

MD7104 1966-72 all..... 14.99 ea



T9496

1964-76 Chrome Oil Pans

These replacement chrome oil pans will fit the chassis just like factory equipment. Replace your dented or stripped out O.E. oil pan with these heavy-duty steel construction O.E.M. style oil pans. These pans hold 5 quarts of oil including filter.

Note: Will not fit any 1973 and later B-Body models.

T9311 1964-76 273,318 & 340..... 119.99 ea

T9496 1966-76 383-440 B/RB & 426 Hemi..... 79.99 ea



1966-76 High Capacity Oil Pan

This black 7 quart high capacity Trans-Dapt oil pan will fit the chassis just like factory equipment. Made from heavy duty steel construction and includes baffles for oil control.

Note: When using stock oil pump on 361-440 use MD7107 pick-up and for 426 Hemi use MD7103 oil pump pick-up.

MN2082 1966-76 361-440 B/RB..... 149.99 ea

MN2082 1966-76 426 Hemi..... 149.99 ea



MN2144

Moroso Chrysler Big Block Oil Pan

Moroso Chrysler big block 361-440 and 426 Street Hemi oil pan works well in chassis with extra low front suspensions. Made in the stock configuration. Features anti slosh baffling. This oil pan is compatible with most starter/flywheel combinations. Made from stamped steel that has a clear zinc coating.

Note: Will not fit 1962-65 production chassis and is not recommended for racing applications due to its shallow sump design.

MN2144..... 219.99 ea

Recommended Pickup

MN2145 fits stock B/RB pumps..... 69.99 ea

New!



MN2502



1964-72 Big Block and Hemi Cast Aluminum Oil Pans

High capacity oil pans for big block 426 Hemi engines fit flush with most frames and provide maximum ground clearance. Features functional cooling fins. Offered as cast or with a polished finish in 7 or 8 quart capacities. Made in the USA.

MN2500 1964-72 7 quart as cast..... 301.99 ea

MN2501 1964-72 7 quart polished..... 445.99 ea

MN2502 1964-72 8 quart as cast..... 445.99 ea

MN2503 1964-72 8 quart polished..... 589.99 ea

Milodon Oil Pans



MD30750

MD30760



Milodon Stock Replacement Oil Pans

These stock replacement oil pans feature a distinctive gold plating that provides long lasting protection against corrosion inside and out. Every pan is 100% leak checked and block checked to the high standards of quality that Milodon is famous for. Flat, unwarped pan rails and proper bolt hole alignment provide for a fit and function that is unmatched in the industry. All pans are specifically designed for use only with Milodon gaskets, sold separately. Also sold separately is Milodon's "crush proof" gasket seal set, item# MD40600 for 318-340 small block or item# MD40650 for 360 small block and item# MD40700 for 383-440 big block. Requires high volume oil pump and pickup screen.

Oil Pans

1960-72 318-340			
MD30750	4-quart	7-1/4" sump depth.....	149.99 ea
1972-86 360			
MD30755	4-quart	7-1/4" sump depth.....	149.99 ea
1965-76 383-440 & Hemi			
MD30760	4-quart	5-1/4" sump depth.....	154.99 ea
MD30761	6-quart	5-1/4" sump depth.....	199.99 ea

Pickups

MD18650	318-360	use with MD30750 or MD30755.....	39.99 ea
MD18660	383-440	3/8" inlet, use with MD30760 or MD30761.....	39.99 ea
MD18662	Hemi	1/2" inlet, use with MD30760 or MD30761.....	39.99 ea



MD30930

MD31010



Milodon Street/Strip Oil Pans

Extra capacity oil pans are ideal for high volume oil pumps. High volume oil pump and extended pickup are required and sold separately.

Note: Pan capacity is quarts full filter.

Oil Pans-Low Profile

1960-72 318-340 ci			
MD30935	8-quart, 8-3/4" sump depth.....	264.99 ea	
1972-up 360 ci			
MD30940	8-quart, 8-3/4" sump depth.....	264.99 ea	
1965-76 383-440 & Hemi			
MD30930	7-quart, 7" sump depth.....	249.99 ea	

Oil Pan - Deep Sump

1962-65 B-Body 383-440 ci			
MD31010	7-quart, 7-3/4" sump depth.....	199.99 ea	

Dipstick for Street/Strip Oil Pan

1960-up 318-360 ci			
MD22060	Stainless steel for MD30935, MD30940.....	61.99 ea	
1965-up 383-440 ci			
MD22070	Stainless steel for MD30930, MD31010.....	66.99 ea	

Extended Pickup

1960-76 318-360 ci - Low Profile Pan			
MD18345	for MD30935, MD30940.....	49.99 ea	
1965-76 383-440 ci			
MD18325	3/8" pipe inlet, for use with MD30930.....	49.99 ea	
1966-71 Hemi			
MD18335	1/2" pipe inlet, for use with MD30930.....	49.99 ea	
1965-up 383-440 ci - Deep Sump Pan			
MD18320	3/8" pipe inlet.....	49.99 ea	
1966-71 383-440 ci			
MD18330	1/2" pipe inlet, use with MD31010.....	49.99 ea	



MD31935

1965-76 Milodon Oil Pan Sets

Oil pan sets contain street/strip oil pan, oil pump pickup, pan gaskets, windage tray and oil pan bolts.

Note: Small block kits include windage tray studs and nuts.

MD31935	1965-76	318-340.....	449.99 set
MD31930	1965-76	383-440.....	444.99 set



MD32230



MD32000



MD32005



Milodon Oil Pan Components

We offer a variety of accessories to complement Milodon oil pans.

Solid Louvered Windage Trays

MD32230	318-360.....	64.99 ea
MD32000	big block, Hemi with stock stroke.....	69.99 ea
MD32005	383-440 up to 1/2" strokers.....	69.99 ea
Windage Tray Install Kit		
81151	small block set.....	59.99 set

Steel Gear Oil Pump Drive Shaft w/Stock Pan

MD21505	BB/Hemi, 7.875" long.....	129.99 ea
---------	---------------------------	-----------

Bronze Gear Oil Pump Drive Shaft w/Stock Pan

MD21525	BB/Hemi, 7.875" long.....	139.99 ea
---------	---------------------------	-----------



MD40700



Milodon Oil Pan Gaskets & Seals

If you're ordering a Milodon pan, you'll need a Milodon gasket and seal to go with it. Choose from a variety of applications and configurations below.

1960-72			
MD40600	318-340ci gasket/seal set.....	24.99 set	
1972-up			
MD40650	360ci gasket/seal set.....	24.99 set	
1965-up			
MD40700	383-440ci gasket/seal set.....	18.99 set	

Oil Pan Components



MN1070



MN1071

1960-74 Windage Trays & Sets

Windage Tray Set

Mopar Performance windage sets are designed to provide improved engine lubrication by reducing interior windage at higher engine speeds. The big block sets includes tray and two pan gaskets and the small block set includes tray and hardware.

Small Block

MN1070	273-340	109.99 set
MN1071	361-440	34.99 set
BRB Wedge 500		
MN2039	with 4.15" stroke	81.99 set

Factory Windage Tray

Replacement small block windage tray. Helps keep oil churning down at high RPM.

MN1069	1968-73 340	44.99 ea
MN1069	1974 360	44.99 ea



Small Block Windage Tray Hardware Set

Mopar Performance windage tray hardware needed for 1967 and later LA small block (318/340/360) engines. These bolts attach to the main cap bolts and are required to mount windage tray.

MN2040	hardware set	89.99 set
--------	--------------	-----------



MN2041

Mopar Performance Oil Pan Gasket Sets

Mopar Performance oil pan gasket sets needed when removing or replacing your oil pan. Each set contains two pans gaskets and two end seals.

MN2041	all V8 except 360	11.99 set
MN2042	360	14.99 set



MN2079

1960-76 Mr. Gasket Oil Pan Gasket Sets

Mr. Gasket oil pan sets made from different materials. The performance high density set is made from a high-density cork/rubber blend. The Ultra-Seal set is made from a cellulose/nitrile composition gasket material. Either set will provide excellent sealing and durability. The High Density set is great for OE replacement or high performance street use, the Ultra-Seal and Performance Composition Material is great for those applications and drag racing and oval track use.

High Density Cork/Rubber Blend

MN2078	1970-76 318, 340 & 360	19.99 set
--------	------------------------	-----------

Ultra-Seal - Composition Material

MN2079	1970-76 318, 340 & 360	19.99 set
--------	------------------------	-----------

Performance Composition Material

MN2080	1960-76 361-440	24.99 set
--------	-----------------	-----------

Note: 2 required with windage tray.



MN1058

1964-76 Fel-Pro Oil Pan Gasket Sets

1964-76 Small Block

MN1058	1964-69 273/318/340	13.99 set
MN1060	1970-74 318/340	13.99 set
MN1061	1971-76 360	12.99 set

1964-76 Big Block

MN1059	1964-76 B & RB Engines	10.99 ea
--------	------------------------	----------



T4346

1964-76 Oil Pan Gaskets

These OE style replacement oil pan gasket sets are bolted between the engine block and the oil pan. The side rails are made of cork and the end seals are made from rubber.

T4345	1964-69 273-340	8.99 set
T4346	1971-76 360	23.99 set



1962-76 Big Block Rear Main Seal

These replacement rear main seals are superior to the stock rope-type seals. The rear main seal is connected to the back of the oil pan and makes a seal against the rear of the engine block. These two-piece neoprene-rubber style rear main seals will make the job easy.

MN2081	1962-76 361-440	29.99 ea
--------	-----------------	----------



1960-76 Oil Pan Bolt Set

Chrysler oil pan bolts for all V8 engines including Hemi. Bolts are coated in black oxide to resist rust. All bolts include washers. 5/16"-18 x 9/16".

MN1062	1960-76 all V8 engines	15.99 set
--------	------------------------	-----------



Made in USA

318-340-360 Oil Pan Hardware Sets

The engineers at ARP developed these unique oil pan studs to install a pan and seal it properly. The studs have a radiused bullet nose that serves to locate the pan rails and allow the nuts to be installed without cross-threading. For those who prefer bolts, ARP has you covered, too. Both studs and bolts are available in black oxide finished chrome moly steel or rust-proof stainless steel in your choice of conventional hex style or the space-saving 12-point nuts. The stud sets come with a special locking 12-point nut, while the bolt sets come with washers. Made in USA.

Stud Sets

AR1429	black oxide	hexhead	71.99 set
AR1430	black oxide	12-point	89.99 set
AR1431	stainless	hexhead	95.99 set
AR1432	stainless	12-point	135.99 set

Bolt Sets

AR20182	black oxide	hexhead	29.99 set
AR20181	black oxide	12-point	31.99 set
AR40182	stainless	hexhead	44.99 set
AR40181	stainless	12-point	46.99 set



Oil Pan Bolt Set

When swapping out your oil pan, replace your worn original bolts with a set of 20 zinc plated steel 5/16" bolts, featuring integrated serrated lock washers. Fits all engines.

MN2185	all	9.99 set
--------	-----	----------

Oil Pan Components



1960-76 Chrome Hex Head Oil Pan Bolt Set

Chrome bolt set includes 2 bolts 1/4"-20 x 1/2" and 20 bolts 5/16" x 18-1/2". Grade 5 washers included. T9272 1960-76 all engines..... 14.99 set



Chrome Dipsticks and Tubes

Authentic Mopar performance chrome dipsticks are designed to fit exactly like the original.

1968-74 Big Block

MN1066 1970-74 B/RB engines 24.99 set

1970-74 Small Block

MN1067 1970-74 LA engines 24.99 set



Reproduction Dipsticks & Tube Components

Original style dipstick and tube assemblies and components for various Mopar engines. Made in the USA.

Note: *MD2345 complete set comes with dipstick, oil tube, oil tube cover and oil tube clamp.

1966-69 Small Block

MD2339 1966-69 dipstick 21.99 ea

MD2340 1966-69 oil tube 9.99 ea

MD2338 1966-69 dipstick & tube 29.99 set

1966-71 Hemi

MD2341 1966-71 Hemi dipstick 21.99 ea

MD2342 1966-71 Hemi oil tube 16.99 ea

MD2343 1966-71 Hemi oil tube cover 14.99 ea

MD2344 1966-71 Hemi oil tube clamp 11.99 ea

MD2345 1966-71 complete assembly 61.99 set

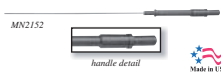

Billet Stainless Steel Engine Dipsticks

These Milodon billet stainless steel dipsticks have a unique design, as well as many functional benefits: all dipstick hardware is CNC machined from billet stainless steel. Fittings, stick and hose are all stainless steel so they will stay bright and rust free even with use in a daily driver. They provide very effective seal for race cars running internal vacuum pump or vacuum system. They also feature an o-ring sealed top to positively seal against water and dirt. Made in the USA.

Note: *Requires tube headers and will not fit with stock cast manifolds.

MD22060 small block w/center sump..... 61.99 ea

MD22070 big block w/center sump 66.99 ea

MN2152 354-392 early Hemi 61.99 ea

MN2153* 5.7L Hemi rear & center sump 64.99 ea

MN2153* 6.1L Hemi rear & center sump 64.99 ea



Chrome Oil Dipsticks And Tubes

Chrome aftermarket dipstick and tube assembly for various engines. Measurements listed are the length of the dipstick minus the handle. Compare length and markings to your original before installation.

Small Block

T9224 318-360 21-3/4" dipstick..... 9.99 ea

Big Block

T9225 383/440 23" dipstick 11.99 ea



Magnetic Oil Drain Plugs

A magnetic oil drain plug is cheap insurance for a high performance engine. Located in the engine oil and transmission pans. These plugs will catch and hold small pieces of metal before they cause damage.

Choose from 3 sizes.

MN2083 1/2" x 20 6.99 ea

MN2084 3/8" self tapping 2.99 ea

MN2085 1/2" self tapping 3.99 ea



1960-76 Oil Pan Drain Plug Gasket

This is a correct replacement gasket which is used to seal the oil pan drain plug and keep it from leaking. G8757 1960-76 1/2" 3.99 ea



1962-74 Oil Pressure Sending Unit

If your oil light's on but your engine still has oil, the oil pressure sending unit might be the culprit. Replace it with this new one.

MN1742 1962-74 w/warning lights..... 9.99 ea

New!

Oil Pressure Switch Socket

Easily remove oil pressure sending units! This socket designed with extra recess to accommodate most oil pressure switches and many brake lamp switches. This 3/8" drive socket features a 1-1/16" hex opening and a durable black oxide coating.

X3923 5.99 ea



1960-76 High-Output Oil Pump Assemblies

Mopar Performance high-output oil pump assemblies provides a 25% increase in oil volume. Ideal replacement for stock pump in high-performance applications.

Note: When replacing your oil pump it is highly recommended to replace the oil pump intermediate shaft.

MN2043 1960-76 small block 84.99 ea

MN2044 1960-76 big block 129.99 ea

MN2044 1960-76 Hemi 129.99 ea



1960-76 Oil Pump Intermediate Shaft

Mopar Performance oil pump intermediate shaft (distributor drive gear assembly) features hardened tip shaft with full radius blend from hex to round and has a pinned gear. This shaft connects the distributor to the oil pump.

MN2046 1960-76 small block 74.99 ea



1962-74 Melting Oil Pumps

Melting oil pumps are manufactured using a proprietary casting process which provides maximum reliability. High volume oil pumps provide a 20-25 percent increase in oil volume to your system.

1962-71 Big Block

M63 1962-71 440 std volume 109.99 ea

M63HV 1962-71 high volume 94.99 ea

1962-76 Small Block

M72 1964-74 standard volume 39.99 ea

M72HV 1964-74 high volume 79.99 ea

1966-71 426 Hemi

M63HV 1962-71 426 Hemi 94.99 ea



Big Block Oil Pump Bolt Set

High strength steel bolt set for big blocks using Melling M63HV high volume oil pump.

MN2413 big block w/M63HV oil pump 14.99 set

Oiling System Components



Flex-Lite Engine Oil Coolers

These high performance Engine Oil Coolers provide additional cooling to protect engine and transmission from overheating. They mount to the front of the radiator or A/C condenser. Comes complete with all hardware, hose, fittings, adapters, and easy to follow instructions. Made in USA.

Standard Cooling - 1/2" Tube Diameter	
FL3951 5" x 20" x 3/4"	114.99 ea
Heavy Duty Cooling - 5/8" Tube Diameter	
FL3953 7" x 21" x 1-1/2", 1/2" barb	224.99 ea
FL45251 7" x 21" x 1-1/2", 1/2" female NPT	134.99 ea
FL45261 10-1/2" x 15" x 1-1/2"	139.99 ea



Derale High Capacity Engine Oil Coolers

This high capacity 6-pass cooler features heavy duty tube and fin, 1/2" seamless copper tubes expanded into 3/4" aluminum extraction, plastic edge guard protectors and an attractive black powder coated finish. Cooler size 7-1/2" x 17" x 3/4".

15502 high-capacity	99.99 ea
---------------------	----------



MN1086



MN2049



MN2047

1960-76 Factory Oil Filters

Chrysler service replacement oil filters for all 1960-76 Mopar engines. Choose from short filters which are optimal for tight areas such as applications with headers, or from Mopar Performance filters for high-performance applications.

Replacement Oil Filters	
MN1086 1960-76 short filter	9.99 ea
MN2049 1962-66 black & yellow logo	25.99 ea
High Performance Oil Filters	
MN2047 all 6 & 8 cylinder	11.99 ea



Factory Oil Pickup Tube & Screen

When replacing an oil pan, don't forget the pickup tube and screen if needed. These corrode and can become clogged over time, so prevent oil starvation by installing a new pickup and screen.

1966-71 Hemi	
MN1072 1966-69 Hemi	34.99 ea
MN1077 1970-71 Hemi	32.99 ea
1967-76 Small Block	
MN1073 1967-76 3/8"	33.99 ea
1968-72 361-383-400 Engines	
MN1076 1968-72 1/2"	89.99 ea
1968-74 383-426-440 Engines	
MN1075 1968-72 3/8"	34.99 ea



Curved Oil Pickup Tube

The curve in this oil pickup tube avoids hitting the internal baffles of most factory style passenger car oil pans. These will also replace applications originally equipped with a straight pickup tube, even if there are no baffles. Depending on the oil pan, your pickup to oil pan clearance should be between 1/4" and 3/8".

Note: Modifications to this pickup may be necessary.

MN2186 V8	35.99 ea
-----------	----------



top detail

Re-Usable Billet Oil Filter

Never buy another oil filter again. The two piece housing with full o-ring seals contains an integral magnet to trap any large particles, while a washable filter element of finely woven stainless steel mesh filters particles down to 45 microns. Just wash every 3000 miles. Get an oil filter that lasts a lifetime at a fraction of the price of other units on the market.

MN2416 all V8	119.99 ea
---------------	-----------



T1067

Chrome Oil Filter Cover

Add protection to your filter while achieving a high performance look! The same concept as the aluminum versions, this chrome plated beauty installs quickly and looks great. Each cover features triple chrome plating for an extra-bright finish.

T1067 5-3/16" tall	5.99 ea
MN2086 4-9/32" tall	11.99 ea



FSS375



FRA300

FilterMag Oil Filter Magnets

FilterMag's powerful rare-earth magnets trap and hold wear inducing metal particles smaller than 40-microns down to 1-micron that the filter cannot stop. The super-strong magnetic force holds FilterMag to the canister. FilterMags are reusable and will reduce maintenance costs by extending the life of your oil. Fits steel oil filter canisters from 2.9" to 5.5" in diameter. The heavy duty/racing FilterMags have a larger curve surface that allows for a stronger magnetic field and a stronger magnetic pull force, designed for more demanding situations. Flat style FilterMags are also available for automatic transmission pans and differential covers.

Standard	
FSS300 2.90"-3.20" 1.90" tall	49.99 ea
FSS375 3.50"-3.80" 2.50" tall	59.99 ea
Heavy Duty/Racing	
FRA300 2.90"-3.20" 2.62" Tall	79.99 ea

Oils & Lubricants



HR Conventional High Performance Oil

From the leader in racing lubricants, now comes a oil designed specifically for high performance engines.

Joe Gibbs Driven HR Oils built on our original formula while adding critical additives to protect engines when they are not running. Our formula uses the same additive technology developed for the U.S. Military for storing and shipping. It protects against rust and corrosion so your engine is protected even when it's not running. It features high levels of Zinc than regular passenger car oils to deliver proper anti-wear protection for older style push-rod and flat-tappet engines.

HR2006	10W30	quart.....	8.99	ea
HR2007	10W30	case of 12 quarts.....	107.99	ea
HR2106	15W50	quart.....	8.99	ea
HR2107	15W50	case of 12 quarts.....	107.99	ea



Break-In Oil

BR is used by Joe Gibbs Racing to break-in and dyno all their NASCAR Nextel Cup and Busch Series engines. This petroleum based oil provides superior break-in properties for flat-tappet engines. The special additive package promotes ring seal and protection for cams and lifters during initial break-in. BR can also be used to break in roller cam engines, and as a general purpose dyno oil.

BR106	15W50	quart.....	8.99	ea
BR107	15W50	case of 12 quarts.....	107.99	ea
BR114	15W50	2-1/2 gallon jug.....	85.99	ea



Royal Purple Synthetic Oil

Royal Purple Motor Oil delivers superior protection and improves performance in four-cycle gasoline and diesel engines. It increases horsepower and torque, saves fuels and reduces heat, wear and emissions. It has unsurpassed oxidation stability that allows for extended oil drains and fewer oil changes, which saves you time and money and reduces the impact on the environment.

Royal Purple's motor oils for passenger cars and trucks are API licensed. Royal Purple's performance advantages come from a blend of synthetic oils plus Royal Purple's proprietary Syntec technology. Royal Purple Motor Oil is compatible with other mineral and synthetic motor oils.

RP01030	SAE30	quart.....	11.99	ea
RP01520	5W20	quart.....	9.99	ea
RP01530	5W30	quart.....	9.99	ea
RP01130	10W30	quart.....	9.99	ea
RP01140	10W40	quart.....	9.99	ea
RP01250	20W50	quart.....	9.99	ea

5 Quart Bottles

RF51520	5W20	5 quarts.....	47.99	ea
RF51530	5W30	5 quarts.....	47.99	ea
RF51130	10W30	5 quarts.....	47.99	ea

Cases

RP12030	SAE30	case of 12 quarts.....	129.99	ea
RP12520	5W20	case of 12 quarts.....	107.99	ea
RP54520	5W20	case of 4-5 quarts.....	188.99	ea
RP12530	5W30	case of 12 quarts.....	107.99	ea
RP54530	5W30	case of 4-5 quarts.....	188.99	ea
RP12130	10W30	case of 12 quarts.....	107.99	ea
RP54130	10W30	case of 4-5 quarts.....	188.99	ea
RP12140	10W40	case of 12 quarts.....	107.99	ea
RP12250	20W50	case of 12 quarts.....	107.99	ea



Hot Rod Vintage Car Oil

From the leader in racing lubricants, now comes an oil designed specifically for hot rods, street rods, and vintage cars. Joe Gibbs Driven Hot Rod Oil takes the formulation used by thousands of racers and adds critical protective chemicals. If your current oil carries an API "donut" symbol, it probably lacks the anti-wear chemistry that historic and racing engines need. Designed specifically for older performance engines featuring high levels of zinc for wear protection and military-grade corrosion inhibitors for storage protection.

HR1506	10W30	quart.....	10.99	ea
HR1507	10W30	case of 12 quarts.....	131.99	ea
HR1606	15W50	quart.....	10.99	ea
HR1607	15W50	case of 12 quarts.....	131.99	ea



BR-30 Break-In Oil

The same high zinc and phosphorus formula as our original break-in oil, now in a SAE 5W-30 viscosity for tight clearance and/or low temperature break-in.

Good for restrictor plate engines, drag race engines, and OEM rebuilds. Provides excellent ring sealing. Does not require additional additives. Good for all pull-downs on the dyno, one night of racing or up to 400 miles on the street.

BR1806	5W30	quart.....	8.99	ea
BR1807	5W30	case of 12 quarts.....	107.99	ea



Royal Purple Engine Break In Oil

Engine builders have grown increasingly concerned that many modern motor oils do not provide adequate wear protection for new engines, particularly those using flat-tappet cams. Royal Purple has addressed this issue by developing a new engine break-in oil. Royal Purple Break-In Oil is formulated to allow optimal ring seal and protect rotating assembly components such as the camshaft and valve train from initial start up wear. Royal Purple combines highly refined mineral oil, preferred for engine break-in, with advanced additives containing high levels of zinc and phosphorus to optimize protection in flat-tappet and roller engines. Royal Purple Break-In Oil is fully formulated and does not require the use of any other chemical additives. Royal Purple recommends using their high performance motor oils after the engine is broken in for maximum engine performance.

RP11487	quart.....	9.99	ea
RP11497	case of 12.....	113.99	ea



Pour Boy All Purpose Filler Spout

Pour Boy all purpose filler spout takes the place of funnels. Its unique, multiple thread design fits a variety of containers from oil bottles to antifreeze, windshield washer fluid to gas treatments, all with an airtight seal! Flow of the fluid is easily controlled by simply bending the spout. No more mess, no more fuss, and no more funnels! 3 per package. 7.99 kit

Engine Assembly Grease

Used by Joe Gibbs Racing during the assembly of every NASCAR Sprint Cup and Nationwide Series engine. This unique formula completely dissolves in oil and can be applied to ring lands in order to prevent micro welding during initial break-in. This assembly grease, combined with the Joe Gibbs BR break-in oil (BR106 or BR107), provides proven protection during break-in.

AG728	1 pound can.....	21.99	ea
AG732	1 oz tube.....	2.99	ea



MSD Performance Ignition

MSD Pro-Billet Distributors

These distributors feature a lightweight CNC-machined 6061-T-6 billet aluminum housing and a polished, coated steel shaft to produce a low-friction durable finish that resists corrosion. MSD uses a sealed ball bearing at the top of the housing and an extra long guided bushing at the bottom to guide and control the shaft smoothly and accurately up to 10,000+ rpm. Other features include an iron drive gear, Rynite™ distributor cap with brass terminals and a high output magnetic pickup to trigger the ignition. Choose from the "standard" Pro-Billet distributors that use the MSD 6, 7, 8 or 10 series ignition control box or from the internally controlled "ready-to-run" distributors.

Note: No further discounts apply.



MSD
PERFORMANCE

"Standard" Pro-Billet Distributors

For MSD 6, 7, 8 or 10 series ignition.

1960-76 Chrysler 273, 318, 340, 360 ci		241.99 ea
1960-76 Chrysler 383, 400 ci		
85451 small diameter, mechanical adv.		305.99 ea
1970-76 Chrysler 426, 440 ci		
8546 small diameter, mechanical adv.		312.99 ea

"Ready-to-Run" Pro-Billet Distributors

Ready-to-run distributors are designed as a plug-n-play distributor. No external ignition control box is needed. Optional vacuum advance is included in select units and can be used at your discretion.

1960-76 Chrysler 273, 318, 340, 360 ci		409.99 ea
8388 w/vacuum advance		409.99 ea
8504 Digital E-Curve w/adj. timing.		439.99 ea
1960-76 Chrysler 383, 400 ci		
8386 w/vacuum advance		434.99 ea
1970-76 Chrysler 426, 440 ci		
8387 w/vacuum advance		409.99 ea

Replacement Parts For MSD Distributors

Replacement parts for MSD Pro-Billet Distributors.

1960-76 Chrysler 273-440		
8433 dist. cap for 85431, 8388, 8504		39.99 ea
8433 dist cap for 8386, 8387		39.99 ea
8431 dist. cap for 85431, 8546		39.99 ea
8467 rotor for 85431, 85451, 8546, 8388		10.99 ea
8467 rotor for 8386, 8387 & 8504		10.99 ea



MSD
PERFORMANCE

MSD Noise Filter

If you experience radio noise after installing the MSD Ignition, you may need to install an MSD Noise Filter. Electro Magnetic Interference (EMI) is occasionally generated from the MSD power cables and can be easily eliminated by installing the Noise Filter on the heavy power supply wires coming from the MSD.

It is recommended that the Noise Filter be used on installations with the MSD 7 and 8 Series Ignitions to prevent this interference. Includes noise filter cover.

Note: No further discounts apply.

8830 MSD noise filter w/cover	44.99 ea
-------------------------------	----------



8920



8910E

MSD Tachometer Adapter

MSD tach adapters will correct the operation of most voltage triggered tachometers or fuel injection systems that do not work directly off the tach output terminal of the MSD ignition unit. If you are triggering an MSD Blaster, 5, 6, SCL, or 7 series ignition with its white wire or points terminal, you will need item # 8910 or 8910E. For applications using green and violet wires for magnetic pickup input, use item # 8920.

Important: For non-current limiting ignitions, originally equipped with a ballast resistor. ** For use on current limiting ignitions, not originally equipped with a ballast resistor.

Note: No further discounts apply.		
8910* points or amplifier		51.99 ea
8910E** points or amplifier		54.99 ea
8920 magnetic pickup		69.99 ea



MSD
PERFORMANCE

MSD Ignition System Coils

The following Blaster Coils share the same special windings and high voltage output as the other Blaster 2 coils, but do not include a ballast resistor. When you are using an MSD Ignition Control, the ignition is responsible for delivering the voltage to the coil so a ballast is not necessary. The Blaster 3 Coil features an extra tall tower design to improve the coil wire attachment and spark isolation and is triggered with a 90° terminal and boot.

Note: No further discounts apply.

8202 Blaster 2	49.99 ea
8223 Blaster 3	49.99 ea



MSD
PERFORMANCE

Blaster Performance Coil

With a stock points style ignition, a ballast resistor must be placed in-line with the positive terminal of the coil. The following Blaster Coils are supplied with a 0.8 ohm ballast resistor plus a terminal and boot to fit most applications. Mallory Unilite applications also require the ballast resistor. Available in chrome or red.

Note: No further discounts apply.		
8200 Blaster 2 chrome		49.99 set
8203 Blaster 2 red		54.99 set



6201

MSD Digital 6A/GAL Ignition Control

MSD's new Digital 6A is the base model of the capacitive discharge multiple spark 6 Series design. Same footprint as the traditional 6A and 6AL but with a lower profile for a sleek look. Like all of the MSD 6 Series Ignitions, the 6A will work with virtually any vehicle as long as it has a 12-18 volt electrical system. It can be triggered using breaker points, a magnetic pickup or the output of an electronic amplifier. All necessary parts and wiring instructions are included. Will work on 4, 6 and 8 cylinder engines. The new Digital 6AL shares the same proven circuitry of the Digital 6A with the addition of a built-in adjustable rev limiter with two top mounted rotary dials. The combination of powerful sparks with the safety of a rev control is what makes the Digital 6AL the most popular ignition control in the world.

Note: No further discounts apply.

6201 all V8		214.99 ea
6425 all V8 with rev limiter		249.99 ea

New!



MSD 6 Series Vibration Mounts

In performance applications such as off-road, racing, and marine applications, strong vibrations can be transmitted through the chassis to the MSD unit. To protect the MSD from excessive vibration, we recommend this vibration mount set.

8823	15.99 set
------	-----------



MSD
PERFORMANCE

Blaster SS Coil

The efficient E-core windings are designed to produce high amounts of current without sacrificing the voltage output. In fact, when used with an MSD 6 Series Ignition, the Blaster SS produces 300 milliamperes with a maximum voltage output of 40,000 volts. The secondary windings are wound on a segmented bobbin which reduces the chance of voltage breakdown between the primary and secondary windings. For more protection, these windings are encased in a polyurethane compound for complete protection against vibration. The Blaster SS features brass terminals and a sturdy Rynite housing. It is supplied with a 90° boot, terminal and vibration mounts.

Note: No further discounts apply.

8207 Blaster SS Coil	54.99 ea
----------------------	----------

Performance Ignition



35051



3506

3507

3508



3510

Pro-Crimp Tool



The Pro-Crimp features interchangeable jaws allowing for a variety of different style crimps with one heavy duty tool. The Pro-Crimp features a hardened steel frame with comfortable molded hand grips. The slick ratchet action provides secure, factory quality crimps every time. The Tool is supplied with precision crimping/stripping jaws for MSD's spark plug wire terminals.

Note: No further discounts apply.



Pro-Crimp Tool	Pro-Crimp tool II	
35051	Pro-Crimp tool II	82.99 ea
Replacement Dies		
3506	Amp pin terminal dies	32.99 ea
3507	Amp lug terminal dies	32.99 ea
3508	Plug wire terminal dies	29.99 ea
3509	Weatherhite terminal dies	42.99 ea
3510	Deutsch terminal dies	42.99 ea



Coil Wires



If you're changing a coil or cap to a new design, you could find yourself searching for different terminals for the coil wire. MSD offers these two style coil wires to make the change easy. Also, remember that the coil wire sees eight times the use of each plug wire so changing the coil wire as a maintenance through the race season is recommended.

Important: * 18" long, straight female socket terminal and boot on one side with a straight female socket distributor cap socket terminal and boot on the other

** 18" long, 90° male coil terminals and boots are installed on both sides to connect to an HEI style terminal. A terminal adapter is also supplied to adapt to a female socket style distributor cap.

Note: No further discounts apply.



84049*	8.5mm Super Conductor	16.99 ea
84039**	8.5mm Super Conductor, red	15.99 ea
84033**	8.5mm Super Conductor, black	16.99 ea



Universal Super Conductor wires shown with multi-angle boots



2-In-1 Universal Wire Sets

These universal spark plug wire sets are made from MSD's Super Conductor performance wire. Universal wire sets have only the spark plug boot and terminal installed. These boots and terminals are available in your choice of a 90° boot or a multi-angle boot. The distributor end boots and terminals are supplied, but not crimped on. Both sets include terminals for engines with either the early style (socket) and late style (HEI) distributor caps. The wires are extra long so they can be cut to fit any application. Each set includes a MSD Mini-Stripper crimper for easy installation. Available with wires in either black or red.

Note: No further discounts apply.

90° Angle

31233	black	99.99 set
31239	red	99.99 set

Multi Angle

31193	black	99.99 set
31199	red	99.99 set



Pro-Clamp Spark Plug Wire Separators

The MSD Pro-Clamp will keep the plug wires in a tidy order and away from engine heat sources. Each Separator features secure grooves for each wire and a top bracket snaps in place to sandwich the wires in place. Each base has a hole for a retaining screw if desired and a tab that will help hold it in position. The kit is supplied with two 4-wire separators, two 3-wire separators and four 2-wire separators.

Note: No further discounts apply.



8843	Pro-Clamp separators	21.99 set
------	----------------------	-----------



Spark Guard

MSD's Spark Guard is a dielectric grease that solves many common ignition troubles. It stops voltage leaks, eases boot removal, prevents moisture buildup inside the spark plug wire boots, and even helps protect against radio noise (EMF). It also simplifies the installation of MSD Universal Spark Plug Wire Sets. Spark Guard will not dry up or harden so it will retain its spark isolating capabilities indefinitely.

Note: No further discounts apply.



8804	spark guard	19.99 ea
------	-------------	----------



MN2519



MN2520

Pro-Billet Electronic Distributor

Pro-billet electronic distributor for small or big block engines. Does not include vacuum advance. TSP Pro Billet distributors can be used with any brand CDI box and has a universal butt connector for easy plug and play.

Note: Requires the use of a CD ignition box.

MN2519	318, 340 & 360	129.99 ea
MN2520	413, 426 & 440	129.99 ea



MN2517

Mopar V8 HEI Electronic Distributor

High quality brass terminals and a protective plastic dust cover that encapsulates the 65,000-volt coil. A new cast-aluminum housing featuring a machine polished finish contains new bushings, mainshaft assembly, and a hardened steel gear. Our HEI includes high-output module, centrifugal advance components, and adjustable vacuum advance canister. For use up to 7,000 RPM.

MN2517	318, 340 & 360	99.99 ea
--------	----------------	----------



MN2521

Mopar V8

"Ready to Run" Electronic Distributor

Our Ready to Run distributors have machine polished aluminum housing with an adjustable vacuum advance module for use up to 7000 RPM and chrome moly steel gear. Requires the use of an external coil.

MN2521	318, 340 & 360	129.99 ea
MN2522	413, 426 & 440	129.99 ea

Mallory Performance Ignition

Say Hello to Performance With Mallory Distributors!
Performance for Every Price Level and Engine/Ignition Combination!



Series 32 Magnetic Breakerless Ignition

These Series 32 distributors use Mallory's Magnetic Breakerless Ignition triggering system, an adjustable mechanical advance, and a steel distributor gear. The CNC-machined billet housings feature ball bearing and bushing shaft support for stability at any RPM, while the 208 (HEI style) cap resists cross-fire.

Note: Requires capacitive discharge ignition system for operation. No further discounts apply.

3257711	1958-78	B engines	289.99 ea
3257811	1959-79	RB engines	294.99 ea
3257911	1965-95	LA engines	294.99 ea



Series 57 Magnetic Breakerless Ignition

These Series 57 distributors use Mallory's Magnetic Breakerless Ignition triggering system, a Mallory Super-Duty (points style) cap with brass terminals, a steel distributor gear, an adjustable mechanical advance, and a vacuum advance. A lockout plate allows operation strictly on mechanical advance. The CNC-machined billet housings feature ball bearing and bushing shaft support for stability at any RPM. Simple, 3-wire hookup makes installation easy. Use with a capacitive discharge ignition system for even more power.

Note: No further discounts apply.

5757801	1959-79	RB engines	439.99 ea
5757701	1958-78	B engines	459.99 ea
5757901	1965-93	LA engines	429.99 ea



Series 42 Magnetic Breakerless Ignition

These Series 42 distributors use Mallory's self-contained Magnetic Breakerless Ignition system, a steel distributor gear, an adjustable mechanical advance, and a vacuum advance. A lockout plate allows operation strictly on mechanical advance. The CNC-machined billet housings feature ball bearing and bushing shaft support for stability at any RPM, while the 208 (HEI style) cap resists cross-fire.

Note: Requires capacitive discharge ignition system for operation. No further discounts apply.

4257711	1958-78	B engines	364.99 ea
4257811	1959-79	RB engines	364.99 ea
4257911	1965-95	LA engines	309.99 ea



Series 50 Magnetic Breakerless Ignition

These Series 50 distributors use Mallory's Magnetic Breakerless Ignition triggering system, a steel distributor gear, an adjustable mechanical advance, and a Mallory Super-Duty (points style) cap with brass terminals. The CNC-machined billet housings feature ball bearing and bushing shaft support for stability at any RPM. Simple, 3-wire hookup makes installation easy. Use with a capacitive discharge ignition system for even more power.

Note: No further discounts apply.

5057801	1959-79	RB engines	434.99 ea
5057701	1958-78	B engines	459.99 ea
5057901	1965-93	LA engines	439.99 ea



Unifite Electronic Ignition

Electronic ignition with a one-piece self-contained optical pickup and module. Utilizes easy 3-wire hookup and adjustable mechanical or mechanical and vacuum advance. Includes Mallory Super-Duty Cap (points style) and rotor with brass terminals. Can be used alone or with high performance coil. Add mode power with a CD ignition system.

Important: Vacuum advance models 50 state legal EOH 0706 & 0709

Note: No further discounts apply.

4757801	1959-79	RB engines	369.99 ea
4757701	1958-78	B engines	369.99 ea
4757901	1965-93	LA engines	369.99 ea



Mechanical Advance

3757801	1959-79	RB engines	319.99 ea
3757701	1958-78	B engines	374.99 ea
3757901	1965-93	LA engines	319.99 ea

Mechanical Advance with Tach Drive

3857801	1959-79	RB engines	529.99 ea
---------	---------	------------	-----------

Series 75 HEI Distributor

This Mallory distributor features steel gears, fully-adjustable advance, and a CNC-machined billet housing with ball bearing and bushing shaft support. It includes a high-output GM-style module with built-in digital rev limiter, a 57,000 volt coil, and a Super Duty distributor cap with brass contacts, all with a simple, 1-wire hookup.

Note: Will not fit A-Body models.

7557901C	1965-95		579.99 ea
----------	---------	--	-----------



Mallory Breakerless Distributor Parts

Need to tune-up your Mallory breakerless distributor? Choose from the parts listed below.

Note: No further discounts apply.

Module	605	all series (except 42, 50 & 57)	106.99 ea
	M609	42, 50 & 57 series	89.99 ea

Distributor Cap	208M	HEI style, all 8 cyl series	45.99 ea
	209M	all 8 cyl series	24.99 ea
	270	all 6 cyl series	24.99 ea

Distributor Rotor	304	32 series	15.99 ea
	307M	42 series	9.99 ea
	335	37 & 38 series	14.99 ea
	322	47 series 8 cyl	15.99 ea
	309	50 series	6.99 ea
	310	57 series	6.99 ea

Distributor Cap & Rotor	2092M	all 8 cyl (exc. 50 & 57 series)	34.99 set
	2091M	50 & 57 series 8 cyl	24.99 set

Harness	29349	all series	16.99 ea
Mechanical Advance	29014	YH and YT series	36.99 ea

Vacuum Advance	29332	47 & 57 series	34.99 ea
-----------------------	-------	----------------	----------

Wire retainer	29314	fits 205/208 cap	14.99 ea
----------------------	-------	------------------	----------



Dual Point Ignition

Economical Dual Point Ignition distributors have heavy duty dual points for increased RPM range and coil output. Choose from mechanical advance or vacuum advance models. A mechanical advance model with mechanical tach drive output is available for those running a mechanical tach.

Note: No further discounts apply.

2557801	1959-79	RB engines	279.99 ea
2557701	1958-78	B engines	359.99 ea
2557901	1965-93	LA engines	349.99 ea



Vacuum Advance	2757801	1959-79	RB engines	409.99 ea
	2757701	1958-79	B engines	409.99 ea

Mechanical Advance - Tach Drive	2657701	1958-79	B engines	469.99 ea
--	---------	---------	-----------	-----------

Performance Ignition



Mallory Breaker Point Distributor Parts

Need to tune-up your Mallory breaker point distributor? Choose from the parts listed below.

Note: No further discounts apply.

Performance Points	
25042X all series.....	21.99 ea
Condenser	
400 all series (except 27).....	7.99 ea
401 27 series.....	9.99 ea
Distributor Cap	
209M all 8 cyl. series.....	24.99 ea
270 all 6 cyl. series.....	24.99 ea
Distributor Rotor	
309 all series (except 27).....	6.99 ea
310 27 series.....	6.99 ea
Distributor Cap & Rotor	
2091M all 8 cyl. series.....	24.99 set
Vacuum Advance	
29332 27 series.....	34.99 ea

High Temperature Wire Divider Kits



Each kit contains two 4-hole brackets, two 2-hole brackets.

Note: No further discounts apply.

29101 red.....	34.99 set
29102 black.....	34.99 set

Mallory Tachometer Adapter



Some applications with a tachometer need a voltage spike signal from the negative side of the coil before they will operate properly. This signal changes when a high inductive storage or capacitive discharge electronic ignition control is installed. The tachometer adapter develops a voltage spike that will run most voltage triggered tachometers and current (series) triggered tachometers. The tachometer adapter works with any inductive storage or capacitive discharge electronic ignition control triggered by points or electronic amplifier trigger. For vehicles w/inductive or capacitive discharge for factory style tach.

Note: No further discounts apply.

29078 for Mallory ignition modules.....	154.99 ea
---	-----------

Mallory Tachometer/ Fuel Injection Adapter



Tachometers/Fuel adapters may be required to generate the correct signal for certain tachometers or fuel injection systems when installing an inductive or CD ignition system. If you are using the points trigger lead (for example points, OEM electronic, Unilite, 50-series or magnetic breakerless, etc.) for the ignition, then the 29074 is the appropriate adapter.

Important: If you are using the output signal directly from the magnetic pickup inside the distributor to trigger a CD ignition control, and your tachometer is not functioning properly, then you will need a different tach adapter, such as Mallory pin 29078.

Note: No further discounts apply.

29074.....	44.99 ea
------------	----------



MN2270

Flame Thrower/Ignitor II Plug N Play Billet Distributors

Plug 'n play billet distributors are designed for maximum ignition performance and easy installation at an affordable price. Replace your outdated points or electronic distributor with this race proven unit. Features patented Ignitor II electronics and a CNC machined 6061 T-6 billet housing. Fits Mopar models with small block or big block engines.

Important: Due to variances in 440 cylinder head castings, some cylinder heads may require grinding for adequate distributor clearance. Will not fit wedge engines with aftermarket heads.

Note: Distributors can not be used with solid core ignition wires. Non vacuum advance distributors do not have an E.Q. number and are not legal for sale or use on pollution controlled vehicles.

Small Block Engines	
With Vacuum Advance	
Black Cap	
MN2270 female terminals.....	269.99 ea
MN2272 male terminals.....	279.99 ea
Red Cap	
MN2271 female terminals.....	269.99 ea
MN2273 male terminals.....	279.99 ea
Without Vacuum Advance	
Black Cap	
MN2274 female terminals.....	269.99 ea
MN2276 male terminals.....	279.99 ea
Red Cap	
MN2275 female terminals.....	269.99 ea
MN2277 male terminals.....	279.99 ea

3B3, 400 Big Block Engines	
With Vacuum Advance	
Black Cap	
MN2278 female terminals.....	269.99 ea
MN2280 male terminals.....	279.99 ea
Red Cap	
MN2279 female terminals.....	269.99 ea
MN2281 male terminals.....	279.99 ea
Without Vacuum Advance	
Black Cap	
MN2282 female terminals.....	269.99 ea
MN2284 male terminals.....	279.99 ea
Red Cap	
MN2283 female terminals.....	269.99 ea
MN2285 male terminals.....	279.99 ea

413, 426, 440 Big Block Engines	
With Vacuum Advance	
Black Cap	
MN2286 female terminals.....	269.99 ea
MN2288 male terminals.....	279.99 ea
Red Cap	
MN2287 female terminals.....	269.99 ea
MN2289 male terminals.....	279.99 ea
Without Vacuum Advance	
Black Cap	
MN2290 female terminals.....	269.99 ea
MN2292 male terminals.....	279.99 ea
Red Cap	
MN2291 female terminals.....	269.99 ea
MN2293 male terminals.....	279.99 ea



MN2246

Flame Thrower/Ignitor III Plug N Play Billet Distributors

Plug 'n play billet distributors are designed for maximum performance and easy installation at an affordable price. Replace your outdated points or electronic distributor with this race proven unit. Features patented Ignitor III electronics and CNC machined 6061 T-6 billet housing. Fits Mopar models with small block or big block engines.

Important: Due to variances in 440 cylinder head castings, some cylinder heads may require grinding for adequate distributor clearance. Will not fit wedge engines with aftermarket heads.

Note: Distributors can not be used with solid core ignition wires. Non vacuum advance distributors do not have an E.Q. number and are not legal for sale or use on pollution controlled vehicles.

Small Block Engines	
With Vacuum Advance	
Black Cap	
MN2246 female terminals.....	289.99 ea
MN2248 male terminals.....	299.99 ea
Red Cap	
MN2247 female terminals.....	289.99 ea
MN2249 male terminals.....	299.99 ea
Without Vacuum Advance	
Black Cap	
MN2250 female terminals.....	289.99 ea
MN2252 male terminals.....	299.99 ea
Red Cap	
MN2251 female terminals.....	289.99 ea
MN2253 male terminals.....	299.99 ea

3B3, 400 Big Block Engines	
With Vacuum Advance	
Black Cap	
MN2254 female terminals.....	289.99 ea
MN2256 male terminals.....	299.99 ea
Red Cap	
MN2255 female terminals.....	289.99 ea
MN2257 male terminals.....	299.99 ea
Without Vacuum Advance	
Black Cap	
MN2258 female terminals.....	289.99 ea
MN2260 male terminals.....	299.99 ea
Red Cap	
MN2259 female terminals.....	289.99 ea
MN2261 male terminals.....	299.99 ea

413, 426, 440 Big Block Engines	
With Vacuum Advance	
Black Cap	
MN2262 female terminals.....	289.99 ea
MN2264 male terminals.....	299.99 ea
Red Cap	
MN2263 female terminals.....	289.99 ea
MN2265 male terminals.....	299.99 ea
Without Vacuum Advance	
Black Cap	
MN2266 female terminals.....	289.99 ea
MN2268 male terminals.....	299.99 ea
Red Cap	
MN2267 female terminals.....	289.99 ea
MN2269 male terminals.....	299.99 ea

Performance Ignition



By **Pertronix**



IGNITOR II

- Increases Horsepower and Fuel Economy.
- Easily Installed in Minutes.
- Legal in all 50 States and Canada.
- 30 Month Warranty

Eliminate points and wear-prone moving parts while delivering twice the stock voltage to the spark plugs. The Ignitor fits completely inside the distributor with no complex wiring, leaving no unsightly black box to clutter up your engine compartment. Use with Flame Thrower 40,000 volt coil for optimum performance.

Note: MN2240, MN2242 are with factory electronic ignitions, excluding lean burn computer controlled engines.

6 Cylinder

MN2239	1960-72	6 cylinder	81.99 set
MN2240	1973-76	6 cylinder	94.99 set

8 Cylinder

MN2241	1968-73	340 Six Pack	84.99 set
MN2242	1972-76	8 cylinder all	94.99 set

Ignitor II

- Increases Horsepower and Fuel Economy.
- Matches dwell to RPM
- Easily Installed in Minutes.
- Legal in all 50 States and Canada.
- 30 Month Warranty

The Ignitor II detects electrical current in the coil and uses a micro controller to increase or decrease dwell to maintain peak energy as RPM and operating conditions change, providing more energy, reducing misfire, and improving engine performance. Produces nearly 4 times more available energy between 3000 and 5000 RPM, and double the available plug voltage! Use with the new Flame-Thrower II super low resistance (0.6 ohms) 45,000 volt coil to maximize high RPM performance.

Note: Ignitor II can not be used with solid core ignition wires. MN2244 and MN2245 are for factory electronic excluding lean burn computer controlled engines. PX91381A is for single point applications only.

6 Cylinder

MN2243	1960-72	6 cylinder	114.99 set
MN2244	1973-76	6 cylinder	129.99 set

8 Cylinder

PX91381A	1964-74	8 cylinder	114.99 set
MN2245	1972-76	8 cylinder	129.99 set

Ignitor III

- Ignition Box Inside Distributor.
- Adaptive Dwell Maintains Peak Energy
- Increases Horsepower, Fuel Economy.
- Legal in All 50 States and Canada.
- 30 Month Warranty

The Ignitor III is the most advanced points replacement set available. Featuring multiple sparks throughout the RPM range and an adjustable REV limiter accurate to 4-50 RPM. Ignitor III generates 5 times more spark than points maintains peak energy, reduces misfire, and improves engine performance throughout the RPM range. Peak current is reached just prior to spark for maximum energy without heat build-up, increasing performance and reliability. Fits Chrysler aluminum bodied single point distributors with vacuum advance.

Note: Not available for 6 cylinder.

PX71381A	1960-72	134.99 set
----------	---------	------------



PX45001

PX45011

Flame Thrower Performance Coils

Complete your ignition upgrade with a Flame Thrower high performance coil. Best when used with the Ignitor Electronic Ignition Conversion, the Flame Thrower Hi Performance Coil fits existing coil brackets for a clean, factory look. Enables larger plug gaps for greater fuel efficiency & more power. Available with either a chrome or black finish. Choose from a variety of voltages and primary resistance ratings.

40,000 Volt Coil - 1.5 & 3.0 ohm

These Flame Thrower coils are compatible with breaker point ignition systems or vehicles equipped with the original Ignitor system. Choice of 6 cyl or 8 cyl.

Chrome Oil Filled

PX40501	6 cyl	3.0 ohm	36.99 ea
PX40011	8 cyl	1.5 ohm	39.99 ea

Black Oil Filled

PX40511	6 cyl	3.0 ohm	34.99 ea
PX40011	8 cyl	1.5 ohm	34.99 ea

Black Epoxy Filled

PX40611	6 cyl	3.0 ohm	41.99 ea
PX40111	8 cyl	1.5 ohm	41.99 ea

45,000 Volt Coil - 0.6 ohm

The Flame Thrower II coils are for use on vehicles equipped with the Ignitor II system.

Chrome Oil Filled

PX45001	4, 6 or 8 cylinder	44.99 ea
---------	--------------------	----------

Black Oil Filled

PX45011	4, 6 or 8 cylinder	36.99 ea
---------	--------------------	----------

Black Epoxy Filled

PX45111	4, 6 or 8 cylinder	45.99 ea
---------	--------------------	----------

45,000 Volt Coil - 0.32 ohm

The Flame Thrower III coils are for use on vehicles equipped with the Ignitor III system.

Chrome Oil Filled

PX44001	8 cylinder	44.99 ea
---------	------------	----------

Black Oil Filled

PX44011	8 cylinder	39.99 ea
---------	------------	----------



PX1382

Pertronix Ignitor Series Ignition Modules

Ignitor Electronic Ignition Module

Eliminates points and moving parts that wear out while delivering twice the voltage to spark plugs. Increase horsepower, fuel economy, and plug life. Concealed entirely within the distributor. Easily installs in minutes with no complex wiring. Compatible with negative-ground 12-volt systems and is legal in 50 states and Canada. 30-month warranty included.

Single Point Vacuum Advance Only

PX1381A	1960-72	79.99 set
---------	---------	-----------

Dual Point Vacuum Advance Only

PX1382	1964-71 B/R/B & Hemi	84.99 set
--------	----------------------	-----------



PX60130

Flame Thrower HV 60,000 Volt Coils

The Flame Thrower HV (high voltage) coils have an E-Core design which is rated at a sizzling 60,000 volts and operates with no degradation of energy throughout the temperature ranges. Made from 6063 T5 aluminum, it efficiently transfers heat to optimize energy output, and the housing is black anodized for increased corrosion resistance. Available in 3 different resistances for compatibility with most points and electronic ignition systems. Standard threaded connections and mounting hardware are included.

PX60104	0.45 ohm	69.99 ea
PX60115	1.5 ohm	69.99 ea
PX60130	3.0 ohm	69.99 ea



1962-76 OEM Reproduction Ignition Coil

Superior quality reproduction ignition coil for use with all 6-cylinder and 8-cylinder Mopar models from 1962 through 1976. An exact reproduction of the original, each ignition coil features the correct vintage Mopar logo. If you're looking for maximum judging points at the car show, this is the ignition coil you need for a truly authentic appearance.

MN1118	1962-76 all engines	59.99 ea
--------	---------------------	----------



1962-74 Replacement Ignition Coil

Service replacement ignition coil for the Chrysler ignition coil, designed for use with all 1962-74 Mopar models with a 6 cylinder or 8-cylinder engine with an external ignition coil.

MN1117	1962-74 all engines	69.99 ea
--------	---------------------	----------

Ignition Components



TSP Power Coil

The TSP power coil is capable of delivering a longer and hotter spark with up to 70% more spark energy than stock ignition coils. Its convenient design easily mounts to fire walls, core supports and fender wells. It features an aluminum heat sink keeping it cooler for more efficient energy output at lower temperatures. Coils have an HEI style output tower and are rated at 50 kV maximum voltage with 260 mA peak current over 0.35 ohm primary resistance. Coils include installation hardware, a coil wire boot with terminal and a wiring harness.

A7700200	red coil	49.99 ea
A7700201	blue coil	49.99 ea
A7700202	black coil	49.99 ea



Mallory 611M Power Cell

Improve performance, increase spark plug life, and enjoy better fuel economy with this universal power cell. The Mallory Ignition Power Cell maintains a constant coil output voltage up to 6500 RPM on stock electronic ignition systems. It delivers smoother engine operation while improving the efficiency of combustion with a more consistent spark. C.A.R.B. approved and ISO state legal.

Note: No further discounts apply.

611M	Mallory Power Cell	39.99 ea
------	--------------------	----------



1962-76 Coil Mounting Brackets

Secures the coil to the intake manifold for various engines listed.

Small Block Engines		
MD7577	1962-76 all except 6 BBL	18.99 ea
MD7578	1968-73 340 6 BBL bracket	34.99 ea
Big Block & Hemi Engines		
MD7576	1962-74 all except 6 BBL	18.99 ea
MD7579	1968-71 440 6 BBL bracket	34.99 ea
Universal Fit Bottle Type Coil Brackets - Chrome		
T9366	1962-76 bracket only	4.99 ea
T9006	1962-76 bracket and cover	6.99 set



1972-76 Electronic Ignition Control Modules

Ignition control module replacement unit for 1972-76 Mopar A, B and E-body models.

CR100	1972-74	21.99 ea
CR114	1975-76	36.99 ea
CR100	1976	21.99 ea



Electronic Ignition Control Units

Mopar Performance electronic control units are a culmination of years of high performance ignition system development. Designed to outperform any ignition unit previously offered to Mopar racers. Fits models with small block, big block, and Hemi engines.

Note: *For race or off-road use only.

MN2209	orange box	up to 6,000 rpm	54.99 ea
MN2210	chrome box	up to 8,000 rpm	89.99 ea
MN2211	super gold	up to 12,000 rpm	215.99 ea



1972-74 ECU Mounting Bracket

Electronic control unit mounting bracket for 1972-74 E-body models. This bracket can also be used when upgrading to electronic ignition. Made from cadmium plated steel as original. Made in USA.

MD4698	1972-74 E-body	31.99 ea
--------	----------------	----------



1964-72 Electronic Ignition Harness

This conversion harness will replace the point style engine harness when upgrading to electronic ignition. Works with any electronic distributor and control unit. Requires 4 wire ballast resistor, electronic distributor, and control unit.

B-Body Models		
MN2197	1964-72 all	45.99 ea
E-Body Models		
MN2197	1970-72 all	45.99 ea
All Models, Mopar Performance		
MN9906	1964-72 all, w/o pigtails	29.99 ea



1960-71 Electronic Ignition Conversion

Electronic ignition conversion set for 1960-71 Mopar engines. Includes electronic distributor with vacuum advance, two-wire ballast resistor, Mopar "orange box" ignition control module, and all necessary wiring and plugs. Complete bolt-on electronic ignition conversion for engines with conventional points and condenser ignition. Wiring modification is necessary on stock ignition wiring. Includes complete wiring instructions.

MN113	1960-71 small block	241.99 kit
MN114	1960-71 361, 383 or 440	241.99 kit
MN115	1960-71 413, 426 or 440	241.99 kit

Electronic Ignition Distributor

Electronic ignition distributors for all models with small block, big block or Hemi engines. Each distributor is designed to function with factory electronic ignition components including electronic ignition control units and external ballast resistor and voltage regulator.

MN1105	383, 400	249.99 ea
--------	----------	-----------

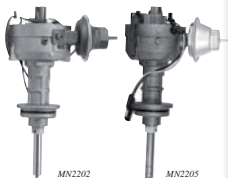

Remanufactured Distributors

These remanufactured distributors feature high performance advance curves and adjustable vacuum advance units. No exchange or core required. Cap and rotor not included.

Single Points W/Single Vacuum		
273, 318, 340, 360 Engines		
MN2202	1961-72	79.99 ea
361, 383, 400 Engines		
MN2203	1961-72	99.99 ea
413, 426, 440 Engines		
MN2204	1961-72	119.99 ea

Electronic Ignition W/Single Vacuum		
400 Engines		
MN2206	1972-76	109.99 ea
440 Engines		
MN2205	1972-78	79.99 ea

Ignition Components



CR904



CR903

Replacement Distributor Caps & Rotors

Applications are available to fit most 1962-76 A-body, B-body and E-body vehicles with electronic ignition. Rotors are manufactured in white polyester. Sets include distributor cap and rotor.

1962-76 - 6 Cylinder

CR904	1962-76	distributor cap.....	6.99 ea
CR903	1962-76	rotor	5.99 ea
CR2201	1962-76	set	14.99 set

1962-76 - 8 Cylinder

CR902	1962-76	distributor cap.....	11.99 ea
CR903	1962-76	rotor	5.99 ea
CR2200	1962-76	set	14.99 set



1962-76 Mopar Distributor Caps

Original-style Mopar distributor cap for various Chrysler 8 cylinder engines.

1962-76 - 8 Cylinder

MN11071	1962-76	tan, std ignition	15.99 ea
---------	---------	-------------------------	----------



CR902G

Gold Quality Distributor Caps & Rotors

Designed for high performance and with premium quality compounds, these components are the ultimate choice for trouble-free service and a longer component life. When you want ignition components that are one step above OE quality, go for the GOLD! Applications are available to fit most 1962-76 A-body, B-body and E-body vehicles with electronic ignition.

1962-76 - 6 Cylinder

CR904G	1962-76	distributor cap	12.99 ea
CR903G	1962-76	rotor	11.99 ea
CR2201G	1962-76	set	16.99 set

1962-76 - 8 Cylinder

CR902G	1962-76	distributor cap.....	11.99 ea
CR903G	1962-76	rotor	11.99 ea
CR2200G	1962-76	set	16.99 set



MD2394

1960-76 Replacement Distributor Rotors

Distributor rotors for 1960-76 Mopar models with single-points ignition, dual points ignition or electronic ignition. This distributor rotor is designed for use with Autolite or Prestolite distributors.

MN1099	1960-71	dual points	6.99 set
MD2394	1962-72	single points	6.99 ea
MD2394	1973-76	electronic ignition.....	6.99 ea



CR101W



CR102W

1972-76 Replacement Reluctors

Electronic ignition reluctor replacement unit for 1972-76 Mopar A, B and E-body 6-cylinder and 8-cylinder models.

CR101W	1973-76	6 cylinder	3.99 ea
CR102W	1972-76	8 cylinder	5.99 ea

New!

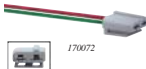

170072



170073

HEI Battery And Tach Pigtail

When installing an HEI distributor or repairing a broken lead, don't use single spade connectors that come loose. Use one of these positive locking HEI pigtails. Pigtails are available in both a dual connection single plug and dual single plug configurations. They both feature red and green wires for easy installation and connection to the distributor.

170072	single dual plug pigtail.....	9.99 ea
170073	dual single plug pigtails.....	4.99 pr



1969 A12 Ballast Resistor Wire

Ballast resistor wire for 1969-1/2 A12 package Road Runner and Super Bee models with 440 6 bbl engines. Vehicles with Six Packs had a different wiring harness so these vehicles need this extension harness while the other models do not. This wire connects from the ballast resistor to the coil.

MN2195	1969	440 6 bbl	28.99 ea
--------	------	-----------------	----------



MN1108



MN1112

RESTORER'S CHOICE™

1960-72 Ignition Point and Condenser Sets

Standard and Restorer's Choice points and condenser sets for most 1960-71 A-body, B-body and E-body vehicles with V8 engines. Replacement points and condensers meet or exceed OEM specifications.

Standard Points

AL1023	1961-71	dual points	9.99 set
AL1044	1962-66	single points	14.99 ea

Restorer's Choice Points

MN1100	1960-63	dual points	10.99 set
MN1108	1960-71	single points	6.99 ea

Standard Condensers

Applications are available to fit most 1960-72 A-body, B-body and E-body vehicles.

AL1531	1960-72	OEM	5.99 ea
--------	---------	-----------	---------

Restorer's Choice Condensers

MN1111	1962-71	dual points	9.99 ea
MN1112	1962-72	single points	7.99 ea



MN1102



MN1103

1964-76 Distributor

Hold Down Brackets & Gaskets

Protect yourself from unwanted timing changes! These distributor hold down clamps prevent the distributor from turning in the intake manifold, ensuring correct timing under any condition. Each clamp set includes the clamp, stud, nut and washer and features a 1 year manufacturer's warranty.

Distributor Hold Down Bracket

MN1102	1964-76	small block, chrome	15.99 ea
MN1103	1964-76	big block, chrome.....	34.99 ea

Distributor Mounting Gasket

6464	1964-76	all engines.....	1.99 ea
------	---------	------------------	---------



MN1110

1960-76 Distributor Advance Components

Distributor Advance Weight Springs

These springs are used to convert a stock distributor to a quick advance curve for enhanced performance. Includes two springs.

MN1110	1960-76	advance springs.....	11.99 pr
--------	---------	----------------------	----------

Distributor Advance Curve Kit

This kit alters the spark and advance curve of your distributors for maximum acceleration. An absolute must for all high-performance engines. 1 year manufacturer's warranty.

T4450	1964-74	advance curve kit.....	3.99 kit
-------	---------	------------------------	----------

Ignition Components



CV1135

CV3033

1961-76 Distributor Vacuum Advances

The vacuum advance is a primary component in your vehicle's ignition system. Attached to the distributor, the vacuum advance is a mechanism that moves the breaker point or pick-up coil plate when it receives vacuum generated by the engine. Applications are available to fit most 1961-76 A-body, B-body and E-body vehicles and replace OEM part numbers listed.

6 Cylinder	
CV 1135 1961-68	all 6 cylinder..... 24.99 ea
CV3011 1969-72	all 6 cylinder..... 19.99 ea
CV3030 1973-74	replaces #3755037... 14.99 ea
CV3030 1973-74	replaces #3755467... 14.99 ea
CV3029 1973-76	replaces #3755042... 19.99 ea
CV3029 1973-76	replaces #3755470... 19.99 ea
CV3029 1973-76	replaces #3874082... 19.99 ea
CV3029 1973-76	replaces #3874714... 19.99 ea
CV3029 1973-76	replaces #3874798... 19.99 ea
CV1176 1976	replaces #3874795... 15.99 ea
8 Cylinder	
CV1135 1961-68	replaces #2098680... 24.99 ea
CV1135 1961-68	replaces #2098685... 24.99 ea
CV3008 1969-72	replaces #3438255... 31.99 ea
CV3008 1969-72	replaces #3656272... 21.99 ea
CV3028 1972-73	replaces #3656341... 21.99 ea
CV3028 1972-73	replaces #3656791... 21.99 ea
CV3028 1972-73	replaces #3656802... 21.99 ea
CV3028 1972-73	replaces #3755157... 21.99 ea
CV3031 1973-76	replaces #3656763... 18.99 ea
CV3031 1973-76	replaces #3656780... 18.99 ea
CV3031 1973-76	replaces #3874298... 18.99 ea
CV3031 1973-76	replaces #3874299... 18.99 ea
CV3031 1973-76	replaces #3874754... 18.99 ea
CV3031 1973-76	replaces #3874755... 18.99 ea
CV3033 1974	replaces #3755512... 17.99 ea
CV3033 1974	replaces #3755518... 17.99 ea
CV3033 1974	replaces #3755522... 17.99 ea
CV3033 1974	replaces #3755681... 17.99 ea
CV3032 1974-76	replaces #3755475... 29.99 ea
CV3032 1974-76	replaces #3755486... 29.99 ea
CV3032 1974-76	replaces #3874090... 29.99 ea
CV3032 1974-76	replaces #3874097... 29.99 ea
CV3032 1974-76	replaces #3874098... 29.99 ea
CV3032 1974-76	replaces #3874115... 29.99 ea
CV3032 1974-76	replaces #3874116... 29.99 ea
CV3032 1974-76	replaces #3874858... 29.99 ea
CV3032 1974-76	replaces #3874859... 29.99 ea
CV3032 1974-76	replaces #3874867... 29.99 ea
CV3032 1974-76	replaces #3874868... 29.99 ea



Bronze Intermediate Shaft Bushing

Intermediate shaft bushings support the distributor intermediate shaft and are pressed into the block. These aftermarket bronze bushings are a significant improvement over the factory aluminum units.

MN2184 1960-76	6 cyl & V8..... 11.99 ea
----------------	--------------------------



MN2125

1960-76 Bronze Distributor Gears

Bronze distributor gears are the first requirement when installing a steel rotor cam. Stock cast iron gears are not compatible with steel camshafts. These are made from an aluminum bronze construction with 5% nickel added. These fit .484" diameter shaft. They feature a high-strength tooth design that resist wear, even when used with high pressure oil pumps.

<i>Note: Will not fit 1964-66 318A with polyspherical heads.</i>	
MN2124 1964-76	273-360 59.99 ea
MN2125 1960-76	383-400 61.99 ea
MN2125 1966-71	426 Hemi..... 61.99 ea



Original Style Intermediate Shaft Bushing

Original Chrysler distributor intermediate shaft bushing for all engines. This bushing supports the intermediate shaft and is pressed into the block. Made from steel.

MN2149 1960-76	V6 & V8 11.99 ea
----------------	------------------------



1969-70 Dual Point Distributor Leads

Original style reproduction dual point distributor leads with correct logo and original style terminal ends. Made from heat resistant wire with resistance welded D-ring terminal and has correct red sleeve for coil mounting.

MN2194 1969-70	340 & 440 6 bbl 41.99 ea
MN2193 1969-70	426 Hemi..... 41.99 ea



Chrome Vacuum Advance Cover

Chrome plated steel cover that slides over factory vacuum advance units. Attaches with double sided tape.

T4973 4.99 ea
-------	---------------



Distributor Wire Grommet

Distributor wire grommet for all models with standard ignition. This rubber grommet shields the wire that runs from the distributor to the ignition coil.

MD2395	all w/points ignition 4.99 ea
--------	-------------------------------------



Spark Plug Hole Thread Chaser

Cleans and threads directly in the spark plug hole! Double ended for both 14mm and 18mm threads. Use with 13/16" spark plug socket.

Y20200 7.99 ea
--------	---------------



Spark Plug Gappers

Gauges and gaps all types of spark plugs from 0.20" to .100" (.50mm to 2.53mm) Includes tapered edge for gauging spark plugs. Specially designed hole with flange adjusts side wire of plug without pressuring center electrode.

Y67870 4.99 ea
--------	---------------



Spark Plug Terminal Pliers

Safely removes spark plug cables. Prevents damage to cables when replacing. The handles and jaws are coated with heavy plastic for a sure grip.

X135 9.99 ea
------	---------------



Spark Plug Gapper & Feeler Gauge Set

All-in-one tool comes with 6 spark plug gap wires, an electrode bending tool, and 12 steel blades. Precision wires and blades can measure both spark plug and ignition system settings. Blades are approximately 1/2" wide by 3 1/2" long. Includes .025", .030", .034", .035", .040" and .045" gap wires, and .010", .012", .015", .016", .017", .018", .019", .020", .022", .024", .025" and .026" blades.

Y67850 8.99 set
--------	----------------

Date-Coded Plug Wires



Correct date code based on production quarter of the vehicle.



Correct "Electronic Suppression" wording on plug wire jacket



1962-72 Model Year Date Coded Spark Plug Wires

Exact reproduction spark plug wire sets are manufactured to original specifications and are correct in every aspect: wire type and length, color, terminals, boot angle and shape, skirt, and braiding (where applicable). These reproduction sets are identical to the spark plug wires as they would have appeared on the vehicle when it shipped from the factory and are designed to look, fit and perform exactly as original. Each wire features original style lettering with the wording "Chrysler Corporation

Electronic Suppression." All wires are date coded based on the production quarter of the vehicle. For cars built during the first half of production (September of the preceding year through February of the car's model year), choose "1Q"; For cars built in the second half of production (March through August of the car's model year), choose "3Q" dated wires.

Note: These plug wires are not designed for use with aftermarket headers or aftermarket manifolds. Wiring must be used with other manifolds or headers but are not guaranteed to fit.

Dodge & Plymouth Spark Plug Wires

Model Year	Configuration	Quantity	Set Price
1962 Model Year			
MD4600	1962 318	3Q-61	78.99 set
MD4601	1962 318	1Q-62	78.99 set
MD4602	1962 361/383	3Q-61 except Max Wedge	78.99 set
MD4603	1962 361/383	1Q-62 except Max Wedge	78.99 set

1963 Model Year			
MD4604	1963 361/383	3Q-62 except Max Wedge	78.99 set
MD4605	1963 361/383	1Q-63 except Max Wedge	78.99 set
MD4606	1963 318	3Q-62	78.99 set
MD4607	1963 318	1Q-63	78.99 set

1964 Model Year			
MD4610	1964 318	3Q-63	78.99 set
MD4611	1964 318	1Q-64	78.99 set
MD4608	1964 361/383/426	3Q-63 except Max Wedge	78.99 set
MD4609	1964 361/383/426	1Q-64 except Max Wedge	78.99 set

1965 Model Year			
MD4612	1965 6 cyl	3Q-64	61.99 set
MD4613	1965 6 cyl	1Q-65	61.99 set
MD4614	1965 318	3Q-64	78.99 set
MD4615	1965 318	1Q-65	78.99 set
MD4616	1965 273	3Q-64	78.99 set
MD4617	1965 273	1Q-65	78.99 set
MD4618	1965 361/383/426	3Q-64	78.99 set
MD4619	1965 361/383/426	1Q-65	78.99 set

1966 Model Year			
MD4620	1966 6 cyl	3Q-65	61.99 set
MD4621	1966 6 cyl	1Q-66	61.99 set
MD4624	1966 273	3Q-65	78.99 set
MD4625	1966 273	1Q-66	78.99 set
MD4622	1966 318	3Q-65	78.99 set
MD4623	1966 318	1Q-66	78.99 set
MD4626	1966 361/383	3Q-65	78.99 set
MD4627	1966 361/383	1Q-66	78.99 set
MD4628	1966 Hemi	3Q-65 street	174.99 set
MD4629	1966 Hemi	1Q-66 street	174.99 set

1967 Model Year			
MD4631	1967 6 cyl	3Q-66	61.99 set
MD4632	1967 6 cyl	1Q-67	61.99 set
MD4630	1967 273/318	3Q-66	78.99 set
MD4633	1967 273/318	1Q-67	78.99 set
MD4636	1967 383	3Q-66	78.99 set
MD4637	1967 383	1Q-67	78.99 set
MD4634	1967 440	3Q-66	78.99 set
MD4635	1967 440	1Q-67	78.99 set
MD4638	1967 Hemi	3Q-66 except R023J/WO23J	174.99 set
MD4639	1967 Hemi	1Q-67 except R023J/WO23J	174.99 set
MD4640	1967 Hemi	1-67 R023J/WO23J	974.99 set
MD4641	1967 Hemi	2-67 R023J/WO23J	974.99 set
MD4642	1967 Hemi	5-67 R023J/WO23J	974.99 set

1968 Model Year			
MD4643	1968 6 cyl	3Q-67	61.99 set
MD4644	1968 6 cyl	1Q-68	61.99 set
MD4645	1968 273/318	3Q-67	78.99 set
MD4646	1968 273/318	1Q-68	78.99 set
MD4647	1968 383/440	3Q-67	78.99 set
MD4648	1968 383/440	1Q-68	78.99 set
MD4649	1968 Hemi	3Q-67 street	174.99 set
MD4650	1968 Hemi	1Q-68 street	174.99 set

Dodge & Plymouth Spark Plug Wires - Continued

1969 Model Year			
MD4651	1969 6 cyl	3Q-68	61.99 set
MD4652	1969 6 cyl	1Q-69	61.99 set
MD4653	1969 318	3Q-68	78.99 set
MD4654	1969 318	1Q-69	78.99 set
MD4655	1969 383/440	3Q-68	78.99 set
MD4656	1969 383/440	1Q-69	78.99 set
MD4657	1969 Hemi	3Q-68 street	174.99 set
MD4658	1969 Hemi	1Q-69 street	174.99 set

1970 Model Year			
MD4659	1970 6 cyl	3Q-69	61.99 set
MD4660	1970 6 cyl	1Q-70	61.99 set
MD4661	1970 318	3Q-69	78.99 set
MD4662	1970 318	1Q-70	78.99 set
MD4663	1970 383/440	3Q-69	78.99 set
MD4664	1970 383/440	1Q-70	78.99 set
MD4665	1970 Hemi	3Q-69 street	219.99 set
MD4666	1970 Hemi	1Q-70 street	174.99 set

1971 Model Year			
MD4667	1971 6 cyl	3Q-70 all	61.99 set
MD4668	1971 6 cyl	1Q-71	61.99 set
MD4669	1971 318/340	3Q-70	78.99 set
MD4670	1971 318/340	1Q-71	78.99 set
MD4671	1971 383/440	3Q-70	78.99 set
MD4672	1971 383/440	1Q-71	78.99 set
MD4673	1971 Hemi	3Q-70 street	174.99 set
MD4674	1971 Hemi	1Q-71 street	174.99 set

1972 Model Year			
MD4675	1972 6 cyl	3Q-71	61.99 set
MD4676	1972 6 cyl	1Q-72	61.99 set
MD4677	1972 318/340	3Q-71 w/o Electronic Ignition	78.99 set
MD4678	1972 318/340	1Q-72 w/o Electronic Ignition	78.99 set
MD4679	1972 400/440	3Q-71 w/o Electronic Ignition	78.99 set
MD4680	1972 400/440	1Q-72 w/o Electronic Ignition	78.99 set

Plymouth Model-Specific Wires

1967-69 Valiant			
MD4681	1967 383	3Q-66	78.99 set
MD4682	1967 383	1Q-67	78.99 set
MD4683	1968 383	3Q-67	78.99 set
MD4684	1968 383	1Q-68	78.99 set
MD4685	1969 383/440	3Q-68	78.99 set
MD4686	1969 383/440	1Q-69	78.99 set

1964-69 Barracuda			
MD4687	1964 V8	3Q-63 all	78.99 set
MD4688	1968 V8	1Q-64 all	78.99 set
MD4690	1964 6 cyl	3Q-63 all	61.99 set
MD4689	1964 6 cyl	1Q-64 all	61.99 set
MD4691	1968 Hemi	9-67 race	974.99 set
MD4692	1968 Hemi	12-67 race	974.99 set
MD4693	1968 Hemi	1-68 race	974.99 set
MD4694	1968 Hemi	2-68 race	974.99 set
MD4695	1969 Hemi	5-68 race	974.99 set

1970 Cuda			
MD4696	1970 340	3Q-69 Six Pack	78.99 set
MD4697	1970 340	1Q-70 Six Pack	78.99 set

Spark Plug Wires



MN1124

Authentic Restoration Spark Plug Wire Sets

These restoration spark plug wire sets are as close to original as possible. Each carbon suppression wire, features correct color or (orange with black boots), lettering and correct spark plug boot. Proper length and diameter for use with factory looms. Each set contains 8 ignition secondary wires and one coil wire. MN1124 1968-73 small block 340..... 45.99 set MN1125 1966-74 big block..... 45.99 set



QW627

1965-76 Custom Spark Plug Wire Sets

Applications are available to fit most 1965-76 A-body, B-body and E-body vehicles. Not for Hemi applications.

6 Cylinder			
QW627	1973-76	all, elec. ignition.....	24.99 set
8 Cylinder			
QW611	1972	all.....	16.99 ea
QW625	1973-76	big block, elec. ign.	31.99 ea
QW629	1965-73	all, std. ignition.....	31.99 set



MN1126

1965-74 Stock Style Ignition Wire Sets

Need to get your Mopar running but don't need concours perfect appearance? Then these spark plug wires are just the thing for you. Designed to functionally replace the original plug wires and install correctly, these plug wire sets are ideal for daily-driven vehicles.

Small Block			
MN1126	1965-73	standard ignition.....	27.99 set
MN1130	1972-74	electronic ignition.....	27.99 set
Big Block			
MN1127	1966-68	all, exc. Hi-Po.....	21.99 set
MN1128	1969	383 Dart.....	30.99 set
MN1128	1969-71	all, Hi-Po.....	30.99 set
MN1128	1972	all, std. ignition.....	30.99 set
MN1129	1972	all, elec. ignition.....	16.99 set
MN1131	1973-74	all.....	38.99 set



Universal Mopar Ignition Wire Set

This 8 mm ignition wire set is specifically made with a suppression core for high performance applications. Wires are blue with the Mopar name imprinted. For small block, big block and Hemi. Hemi engines require insulators and boots for each plug wire. MN2216 cut to fit..... 81.99 set



42570

Custom Plug Wire Loom Set

Get a clean custom look while protecting your ignition wires from chafing or contact with exhaust headers. Designed to fit on most small and big block V8 engines. Includes polished billet aluminum wire looms, 8' feet of 1/2" stainless conduit, 16 chrome wire terminator end caps, and 16 wire protection sleeves.

Note: No further discounts apply.

42570	ball milled wire loom set.....	129.99 set
42569	flamed wire loom set.....	129.99 set
42573	plain wire loom set.....	129.99 set



10012

Spark Plug Index Washers

These soft copper washers help increase horsepower and reducing detonation. They allow the spark plugs ground and electrode opening to be indexed in their optimal position for better combustion and reduced hot spots on the electrode. Available for both tapered and flat sealed 14mm spark plugs in packages of 30. Each set includes 10 washers in three different thicknesses. 10012 tapered indexing set..... 29.99 set 10022 flat indexing set..... 29.99 set



Hemi Spark Plug Tubes And Seals Set

Service replacement spark plug tube and seal set for Mopar Hemi engines. Spark plug tubes are necessary to create a seal to prevent oil from the valve cover area of the cylinder head from escaping and to protect the spark plugs and wires from oil as they go through the valve cover and into the head. Each complete set includes 8 tubes and seals. MN1128 1966-71 tubes & seals..... 119.99 set



Made in USA

1965-71 426 Hemi Spark Plug Boot

Replacement of the original spark plug boot designed for Hemi engines with power brakes. Measures 4-11/16" long with a 5/16" upper ID and a 5/8" lower ID. Made in USA.

MD2083 1965-71 spark plug boot..... 19.99 ea



Hemi Spark Plug Insulator and Boot Set

Mopar Performance Hemi spark plug insulator and boot set needed to service one cylinder (eight required per engine).

MN2217..... 21.99 set



Mopar Performance Spark Plug Wire Removal Tool

This Mopar Performance tool allows easy removal of spark plug wires without pulling the wire out of the terminal end and boot. Made from steel with a rubber coated handle. MN2221..... 26.99 ea

Spark Plug Wire Retainers

New!

TAYLOR



A970125C

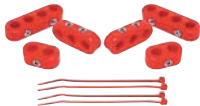

A970126R

Clamp Style Wire Separators

Organize your engine bay with Taylor clamp style wire separators. Manufactured from nonconductive type 6/6 nylon that won't melt, distort, fade or crack. Each six piece set includes two 4 wire separators, two 3 wire separators, and two 2 wire separators. Available in four different colors. Stainless steel hardware included.

7-8.2mm Wire Separators

A970125C	chrome	9.99 set
A970125K	black	13.99 set
A970125R	red	13.99 set
A970125B	blue	13.99 set

10.4mm Wire Separators

A970126K	black	15.99 set
A970126R	red	15.99 set
A970126B	blue	15.99 set

New!

ACECEL



Spark Plug Indexing Tool

This tool makes indexing spark plugs easier. Made from gold anodized billet aluminum, it accepts both tapered and flat sealed 14mm spark plugs. The tool has knurled edges for hand held use or it can be locked into a vice on its flat edges. Simply mark your desired ground electrode position and place index washers on the spark plug until the electrode lines up to the mark.
10052 indexing tool..... 22.99 ea



Made in USA

1966-67 A-Body Spark Plug Wire Retainer

Spark plug wire bracket for 1966-67 Mopar A-Body models. This small bracket mounts on the left front exhaust manifold stud with "L" bracket and holds plug wires 1, 3 and 5. Manufactured in correct gauge steel and thermoplastic coated as original. Made in USA.
MA4700 1966-67 plug wire bracket..... 13.99 ea



MD2406



MD2407

1966-74 A, B & E-Body

Big Block Plug Wire Retainer Sets

These complete bracket sets include all plug wire retainers needed for Mopar A & B-Body models with big block engine. Manufactured from correct gauge steel and thermoplastic coated as original. Made in USA.

A-Body Sets

MA4701	1967	big block	86.99 kit
MA4702	1968	big block	89.99 kit
MA4703	1969	big block	86.99 kit

B-Body Sets

MN2222	1966-67	big block	69.99 kit
MN2223	1968	big block	75.99 kit
MD2406	1969	big block	74.99 kit
MD2407	1970-71	big block	69.99 kit
MN2224	1972-74	big block	69.99 kit

E-Body Sets

MD2407	1970-71	big block	69.99 kit
--------	---------	-----------	-----------



Made in USA



MD2410



MD2402



MD2403



MD2411

1966-74 Spark Plug Wire Retainers

Replacement spark plug wire retainers for 1966-74 A-Body, B-Body and E-Body models equipped with small block, big block or Hemi engines. A variety of applications are available individually or in kits. Note: *Also fits 1970 Hemi Charger with round air cleaner. **A/E-Body only.

Small Block Engines

Mounts To Valve Cover

MD2401	1966-68	retains 4 plug wires	3.99 ea
MD2409	1969-74	retains 4 plug wires	3.99 ea
MD2412**	1970-74	retains 2 wires	3.99 ea

Big Block Engines

Mounts To Exhaust Manifold Front Corners

MD2400 1966-68 19.99 pr

Mounts To LH Exhaust Manifold Corner

MD2404 1968-74 3.99 ea

Mounts To Thermostat Housing Bolt

MD2410 1969-76 12.99 ea

426 Hemi Engines

Mounts To Upper Coil Bracket

MD2402* 1966-70 14.99 ea

Mounts To Front Throttle Return Spring Bracket

MD2403* 1966-70 14.99 ea

MD2411 1970-71 14.99 ea



MN1121

Made in USA

1968 A-Body 340 Spark Plug Wire Retainer

Spark plug wire bracket for 1968 Mopar A-Body models equipped with a 340ci engine. This special bracket mounts at the rear of the 340ci engine to keep the plug wires away from the throttle cable and automatic kickdown linkage. Manufactured using correct gauge steel and then thermoplastic coated as original. Made in USA.
MA4699 1968 plug wire bracket..... 19.99 ea



MN1120

Made in USA

Big Block #6 & #8 Spark Plug Wire Shields

This shield bolts under the sixth and seventh head bolt to protect #6 and #8 spark plug wire boot. Made in USA.
MN1121 1966-69 head shield 11.99 ea
MN1120 1970-74 head shield 11.99 ea

Resistors & Regulators



Made in USA

Big Block #7 Spark Plug Wire Heat Shield

Spark plug wire shield for use with all Mopar Big Block engines from 1960-76. This replacement spark plug wire shield mounts to the fourth exhaust manifold stud from the front of the engine to protect the #7 Spark Plug Wire boot. Made in USA.
MN1119 1960-76 heat shield..... 11.99 ea



Spark Plug Wire Separator Set

This set of spark plug wire separators is made from high grade plastic which helps insulate the plug wires and reduce shorts and crosstalk. Includes two (4) wire separators, two (3) wire separators, and two (2) wire separators.
MN2417 V8..... 2.49 set



Spark Plug Wire Support and Separator Set

These high grade chrome plated plastic support brackets attach to the valve cover bolts or studs to route the plug wires neatly from the distributor, over the valve covers, and to the plugs. Keeps wires away from hot underhood parts, insulates the plug wires, and reduces shorts and crosstalk. Includes four support brackets, two (3) wire separators, and four (2) wire separators, as shown above.
MN2418 V8..... 4.99 set



Universal Fit Spark Plug Wire Loom Set

Universal spark plug wire loom set for 7 mm and 8 mm wire. Includes four steel 1/4" mounting studs.
Note: Not for use with cast aluminum valve covers.
MN2215..... 26.99 set



1962-76 Ballast Resistor

Replacement ballast resistor for 1962-76 Mopar models. This resistor is designed to look, install and function exactly as original. The ballast resistor works in conjunction with the ignition coil. During low speed operation, the ballast resistor heats up. The increase in temperature causes an increase in resistance in the ignition system and ultimate failure in the ballast resistor. Keep a spare in your glove box!
MN1132 1962-72 std. ign., OEM..... 34.99 ea
MN1133 1962-72 std. ign., aftermarket..... 4.99 ea
MN1134 1972-76 electronic ign..... 5.99 ea



1972-76 Ballast Resistor Wiring Connector

Replacement ballast resistor wiring prong/connector for Mopar vehicles with Electronic Ignition or large 4-prong ballast resistors.
MD4500 1972-76 electronic ignition..... 7.99 ea



1962-72 Ballast Resistor Bracket

Ballast resistor bracket for all 1962-72 Mopar models with points ignition. The ballast resistor mounts to this bracket.
MN1136 1962-72 standard ignition..... 15.99 ea



1970-71 Date Coded Voltage Regulators

Mopar performance date coded voltage regulators a must for a correct restoration. For use with external regulator models. A voltage regulator is an electrical device needed to control the output of a generator or alternator.

MN2180 1970 #419, 41st week of 1969 29.99 ea
MN1140 1970-71 #271, 27th week of 1971 36.99 ea
MN2181 1970-71 #321, 32nd week of 1971 29.99 ea



1960-76 Replacement Voltage Regulators

A voltage regulator is used to control the output of an alternator or generator. Regulators are either internal or external. Internal regulators are mounted in the alternator housing, external regulators are typically located on the fender well in the engine compartment. Applications are available to fit all models with all engines for the year ranges specified.

1960-76 Service Replacement Voltage Regulators
VR1115 1960 all..... 57.99 ea
VR706 1961-69 all..... 39.99 ea
VR733 1970-76 all..... 29.99 ea

1961-69 OE Appearance Voltage Regulator
MD2439 1961-69 all..... 24.99 ea
1962-73 Mopar Performance Voltage Regulator
MN1140 1970-73 all..... 36.99 ea



1964-69 Voltage Regulator Pigtails

Replacement voltage regulator pigtail for all 1964-69 Mopar models. These harnesses connect the voltage regulator to the rest of the engine by wiring harness.
MN2192 1964-69 all..... 5.99 ea

HAL STUFF Underhood Wiring Conduit

De-Clutter Your Engine Bay!

Take the ugly out of your electrical wiring with HAL STUFF wiring conduit. All of the major components are triple chrome plated or are polished 304 stainless steel. Choose from a complete starter set with accessories, or piece together your own custom application!



New!



Complete Conduit Starter Set

Is your hood hiding a mess of wiring and vacuum lines? De-clutter your engine bay with this conduit set! This set includes 15 feet of 1/2" polished stainless steel flexible conduit, enough for most applications, as well as six chrome 1/2" conduit terminators, two 1.50" x 2" chromed aluminum enclosures, chrome aluminum fire wall pass through, and twelve 1/2" nickel-plated mounting clips.

42565 conduit starter set 129.99 ea

Billet Choke Covers

These chrome-plated choke covers enhance the appearance of dressed engines by covering the plastic choke on Edelbrock, Demon, and Holley carburetors. Each billet aluminum cover comes with a snap-in louvered insert. Available as an individual cover or as a kit with polished stainless steel conduit.

New!



42567 choke cover 23.99 ea
42563 choke cover kit 44.99 ea

New!



Firewall Pass Through Enclosure

Complement your stainless steel conduit with this firewall pass-through! This chrome-plated aluminum enclosure makes it easy to pass wires through to the engine compartment. Machined with two holes for terminators and fitted with a rubber grommet for firm seal. Includes stainless mounting hardware and cover gasket.

Note: Enclosure does not include conduit or terminators.
42564 firewall pass through enclosure..... 24.99 ea



New!



Flexible Stainless Steel Conduit

Customize your engine bay with this polished stainless steel conduit! Flexible enough to be routed in virtually any shape or direction, this conduit protects wiring and vacuum lines while providing a clean, clutter-free appearance under the hood.

42571 1/4" conduit 5 foot roll 12.99 ea
42561 3/8" conduit 10 foot roll 29.99 ea
42560 1/2" conduit 10 foot roll 34.99 ea

New!



42557

Universal Aluminum Enclosures

Clean up junction blocks and terminals with these chrome-plated aluminum enclosures! These universal enclosures feature a ball milled style cover and can be used as junction or termination blocks for wiring when incorporated with the flexible stainless steel conduit termination fittings.

Note: Enclosures do not include holes for mounting or conduit terminator installation
42556 small 1.50" x 2" 13.99 ea
42557 large 2.062" x 2.562" 16.99 ea

New!



42580

42559

42558

Conduit Termination Accessories

Organize your stainless steel conduit with these chrome plated terminators! These connectors and terminators accent your engine bay while protecting wires and hoses from engine heat, dirt, and debris. Available in three diameters with a common thread size for each to fit the end caps and tees.

42580 1/4" terminator 4.99 ea
42551 3/8" terminator 4.99 ea
42550 1/2" terminator 4.99 ea
42559 terminator end cap 3.99 ea
42558 t-fitting 7.99 ea

New!



42552

Conduit Mounting Clips And Brackets

These bright nickel plated clips secure your stainless conduit to keep your installation looking clean and professional. Use with the chrome plated universal mounting brackets to allow spacing from fender wells, fire walls or can even be used on the engine.

42552 3/8" mounting clips (12 pk) 5.99 set
42553 1/2" mounting clips (12 pk) 5.99 set
42555 universal mounting bracket 5.99 ea

Belts and Alternators

1969-72 Authentic Style Alternator Belts

Replace potentially troublesome parts with our original style reproduced belts. Officially licensed by Mopar, they feature indented imprinting of the correct Mopar part numbers, manufacturer's code, appropriate date code, Chrysler Pentastar logo and they are cloth wrapped. These authentic looking reproductions are the finishing touch to any serious restoration and a great way to gain points over your car show competitors. Officially licensed by Mopar!

B4601

B4601	1969	Barracuda, 318, 340 w/ AC	33.99	ea
B4600	1969	Barracuda, 318, 340, 383, 440 w/o AC	33.99	ea
B4701	1970	Barracuda, 318, 340, 360 w/o AC	33.99	ea
B4703	1970	Barracuda, 383, 440 w/o AC	33.99	ea
B4706	1970	Barracuda, 426 Hemi	33.99	ea
B4700E	1971	Barracuda, 318, 340, 360 w/ AC	33.99	ea
B4701E	1971	Barracuda, 318, 340, 360 w/o AC	33.99	ea
B4703E	1971	Barracuda, 383, 440 w/o AC	33.99	ea
B4705E	1971	Barracuda, 383, 440 w/ AC	33.99	ea
B4706E	1971	Barracuda, 426	33.99	ea
B4740	1972	Barracuda, 318, 340, 360 w/o AC	33.99	ea
B4600	1969	Belv.Chrg. 273, 318, 340, 383, 440 w/o AC	33.99	ea
B4600	1969	Cmt. Rd Rtr. 273, 318, 340, 383, 440 w/o AC	33.99	ea
B4601	1969	Belv. Chrg. Cmt. Rd Rtr. 318, 340 w/ AC	33.99	ea
B4603	1969	Belv. Chrg. Cmt. Rd Rtr. 426	33.99	ea
B4701	1970	Belv. Chrg. Cmt. Rd Rtr. 318, 340, 360 w/o AC	33.99	ea
B4702	1970	Belv. Chrg. Cmt. Rd Rtr. 360 w/60 amp	33.99	ea
B4702	1970	Cmt. Rd Rtr. 318, 340, 360 w/60 amp	33.99	ea
B4703	1970	Belv. Chrg. Cmt. Rd Rtr. 383, 440 w/o AC	33.99	ea
B4706	1970	Belv. Chrg. Cmt. Rd Rtr. 426	33.99	ea
B4700E	1971	Belv. Chrg. Cmt. Rd Rtr. 318, 340, 360 w/ AC	33.99	ea
B4701E	1971	Belv. Chrg. Cmt. Rd Rtr. 318, 340, 360 w/o AC	33.99	ea
B4702E	1971	Belv. Chrg. Cmt. Rd Rtr. 360 w/60 amp	33.99	ea
B4702E	1971	Cmt. Rd Rtr. 318, 340, 360 w/60 amp	33.99	ea
B4703E	1971	Belv. Chrg. Cmt. Rd Rtr. 383, 440 w/o AC	33.99	ea
B4705E	1971	Belv. Chrg. Cmt. Rd Rtr. 383, 440 w/ AC	33.99	ea
B4706E	1971	Belv. Chrg. Cmt. Rd Rtr. 426	33.99	ea
B4740	1972	Belv. Chrg. Cmt. Rd Rtr. 318, 340, 360 w/o AC	33.99	ea
B4741	1972	Belv. Chrg. Cmt. Rd Rtr. 400, 440 w/o AC	33.99	ea
B4701	1970	Challenger, 318, 340, 360 w/o AC	33.99	ea
B4703	1970	Challenger, 383, 440 w/o AC	33.99	ea
B4706	1970	Challenger, 426 Hemi	33.99	ea
B4702	1970	Challenger, 318, 340, 360 w/o AC	33.99	ea
B4701E	1971	Challenger, 318, 340, 360 w/o AC	33.99	ea
B4703E	1971	Challenger, 383, 440 w/o AC	33.99	ea
B4705E	1971	Challenger, 383, 440 w/ AC	33.99	ea
B4706E	1971	Challenger, 426	33.99	ea
B4740	1972	Challenger, 318, 340, 360 w/o AC	33.99	ea
B4702	1969	Chrysler Pass. Car, 383, 440 w/o AC	33.99	ea
B4701	1970	Chrysler Pass. Car, 318, 340, 360 w/o AC	33.99	ea
B4704	1970	Chrysler Pass. Car, 383, 440 w/o AC	33.99	ea
B4701E	1971	Chrysler Pass. Car, 318, 340, 360 w/o AC	33.99	ea
B4704E	1971	Chrysler Pass. Car, 383, 440 w/o AC	33.99	ea
B4705E	1971	Chrysler Pass. Car, 383, 440 w/ AC	33.99	ea
B4740	1972	Chrysler Pass. Car, 318, 340, 360 w/o AC	33.99	ea
B4741	1972	Chrysler Pass. Car, 400, 440 w/o AC	33.99	ea
B4601	1969	Dart, 318, 340 w/ AC	33.99	ea
B4610	1969	Dart, 318, 340	33.99	ea
B4701	1970	Dart, 318, 340, 360 w/o AC	33.99	ea
B4702E	1971	Dart, 318, 340, 360 w/ AC	33.99	ea
B4701E	1971	Dart, 318, 340, 360 w/o AC	33.99	ea
B4740	1971	Dart, 318, 340, 360 w/o AC	33.99	ea
B4600	1969	Dodge/Ply. 273, 318, 340, 383, 440 w/o AC	33.99	ea
B4601	1969	Dodge/Ply. 318, 340 w/ AC	33.99	ea
B4602	1969	Dodge/Ply. 383, 440 w/o AC	33.99	ea
B4701	1970	Dodge/Ply. 318, 340, 360 w/o AC	33.99	ea
B4702	1970	Dodge/Ply. 318, 340, 360 w/60 amp	33.99	ea
B4704	1970	Dodge/Ply. 383, 440 w/o AC	33.99	ea
B4700E	1971	Dodge/Ply. 318, 340, 360 w/ AC	33.99	ea
B4701E	1971	Dodge/Ply. 318, 340, 360 w/o AC	33.99	ea
B4702E	1971	Dodge/Ply. 318, 340, 360 w/60 amp	33.99	ea
B4704E	1971	Dodge/Ply. 383, 440 w/o AC	33.99	ea
B4705E	1971	Dodge/Ply. 383, 440 w/ AC	33.99	ea
B4740	1972	Dodge/Ply. 318, 340, 360 w/o AC	33.99	ea
B4741	1972	Dodge/Ply. 400, 440 w/o AC	33.99	ea
B4742	1972	Dodge/Ply. 400, 440 w/60 amp	33.99	ea
B4601	1969	Valiant, 318, 340 w/o AC	33.99	ea
B4701	1970	Valiant, 318, 340 w/o AC	33.99	ea
B4700E	1971	Valiant, 318, 340, 360 w/ AC	33.99	ea
B4701E	1971	Valiant, 318, 340, 360 w/o AC	33.99	ea
B4740	1972	Valiant, 318, 340, 360 w/o AC	33.99	ea

1960-76 Generators & Alternators

Direct replacement for a worn-out or non-functional original alternator. These quality remanufactured alternators will install and function as original. Applications are available for most 1960-76 A-body, B-body and E-body vehicles.

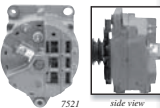

6 Cylinder					
9112	1960-61	30A	170	generator	135.99 ea
7007	1961-69	60A	170	1-groove pulley	47.99 ea
7006	1961-69	60A	170	2-groove pulley	54.99 ea
7024	1970-74	60A	198	1-groove pulley	79.99 ea
7509	1970-74	78A	198	2-groove pulley	69.99 ea
7521	1970-74	100A	198	2-groove pulley	114.99 ea
7007	1961-69	60A	225	1-groove pulley	47.99 ea
7006	1961-69	60A	225	2-groove pulley	54.99 ea
7024	1970-76	78A	225	1-groove pulley	79.99 ea
7509	1970-76	78A	225	2-groove pulley	69.99 ea
7521	1970-76	100A	225	2-groove pulley	114.99 ea

8 Cylinder					
Small Block V8					
7007	1964-69	60A	273	1-groove pulley	47.99 ea
7006	1964-69	60A	273	2-groove pulley	54.99 ea
7007	1961-69	60A	318	1-groove pulley	47.99 ea
7006	1961-69	60A	318	2-groove pulley	54.99 ea
7024	1970-76	78A	318	1-groove pulley	79.99 ea
7509	1970-76	78A	318	2-groove pulley	69.99 ea
7521	1970-76	100A	318	2-groove pulley	114.99 ea
7007	1968-69	60A	340	1-groove pulley	47.99 ea
7006	1968-69	60A	340	2-groove pulley	54.99 ea
7024	1970-73	60A	340	1-groove pulley	79.99 ea
7509	1970-73	78A	340	2-groove pulley	69.99 ea
7521	1970-73	100A	340	2-groove pulley	114.99 ea
7024	1974-76	60A	360	1-groove pulley	79.99 ea
7509	1974-76	78A	360	2-groove pulley	69.99 ea
7521	1974-76	100A	360	2-groove pulley	114.99 ea

Big Block V8					
7007	1961-65	60A	361	1-groove pulley	47.99 ea
7006	1961-65	60A	361	2-groove pulley	54.99 ea
7007	1962-69	60A	383	1-groove pulley	47.99 ea
7006	1962-69	60A	383	2-groove pulley	54.99 ea
7024	1970-71	60A	383	1-groove pulley	79.99 ea
7509	1970-71	78A	383	2-groove pulley	69.99 ea
7521	1970-71	100A	383	2-groove pulley	114.99 ea
7024	1972-74	60A	400	1-groove pulley	79.99 ea
7509	1972-74	78A	400	2-groove pulley	69.99 ea
7521	1972-74	100A	400	2-groove pulley	114.99 ea
7007	1961-62	60A	413	1-groove pulley	47.99 ea
7006	1961-62	60A	413	2-groove pulley	54.99 ea
7007	1963-69	60A	426	1-groove pulley	47.99 ea
7006	1963-69	60A	426	2-groove pulley	54.99 ea
7024	1970-71	60A	426	1-groove pulley	79.99 ea
7509	1970-71	78A	426	2-groove pulley	69.99 ea
7521	1970-71	100A	426	2-groove pulley	114.99 ea
7007	1966-69	60A	440	1-groove pulley	47.99 ea
7006	1966-69	60A	440	2-groove pulley	54.99 ea
7024	1970-74	60A	440	1-groove pulley	79.99 ea
7509	1970-74	78A	440	2-groove pulley	69.99 ea
7521	1970-74	100A	440	2-groove pulley	114.99 ea

MSD DynaForce Alternators

MSD *Power* **New!**

Street Series alternators are offered with chrome, black, and natural finishes and are designed to fit most custom bracket sets that use a GM style alternator and install with a simple one wire hook up to the battery post. Racing alternators are available in 50 amp Denso style or 100 amp GM style and are compatible with 12 and 16 volt electrical systems thanks to an adjustable voltage regulator. They feature the same one wire hook up and a red wrinkle finish. Every alternator assembly is tested and is delivered with proof of performance. Made in USA.



Note: No further discounts apply.

Street Alternators		Track/Racing Alternators	
5321	120 amp black	261.99 ea	
5361	150 amp chrome	279.99 ea	
5322	120 amp chrome	277.99 ea	
5362	160 amp chrome	324.99 ea	
	W580 100 amp	red	359.99 ea

Alternators / Brackets



MN2156

1961-76 75-Amp Alternators

Chrome 75-amp Alternators. Classic offers higher amperage than stock replacement alternators for 1961-76 A-body, B-body and E-body vehicles. Available in single or 2-wire connections and with single or double pulleys.

Single Wire Connection

1-Groove Pulley	MN2156 1961-76	199.99 ea
2-Groove Pulley	MN2158 1961-76	199.99 ea

2-Wire Connection

1-Groove Pulley	MN2157 1961-76	179.99 ea
2-Groove Pulley	MN2159 1961-76	179.99 ea



1961-76 200-Amp Alternators

Chrysler Upgrade 200-amp Alternators for small block Chrysler engines. Classic Industries® offers higher amperage than stock replacement alternators for 1961-76 A-body, B-body and E-body vehicles. Single wire connection with a double pulley and internal regulator. These alternators feature excellent idle output, heavy duty rectifier and gold battery post.

Note: Some modifications to the mounting bracket will be necessary.

2-Groove Pulley	MN2163 natural	389.99 ea
-----------------	----------------	-----------



MN2160

1961-76 140-Amp Alternators

Chrysler Upgrade 140-amp Alternators for small block Chrysler models. Classic offers higher amperage than stock replacement alternators for 1961-76 A-body, B-body and E-body vehicles. Single wire connection with a double pulley and internal regulator. These alternators feature excellent idle output, heavy duty rectifier and gold battery post.

Note: Some modifications to the mounting bracket will be necessary.

2-Groove Pulley	MN2160 chrome	249.99 ea
	MN2161 natural	199.99 ea
	MN2162 black	209.99 ea



MD2426

1966-74 Alternator Bracket Set

Replacement bracket kits feature correct length bolts, thick flat washer and 3 spacers. Triangle and adjusting bracket black-dipped as original. Made in USA.

Small Block

With Water Pump Casting #2402794 or 2863067	MD2426 1966-69 bracket...	39.99 set
With Aluminum Water Pump Casting # 3420037	MD2428 1970-74 bracket...	39.99 set

Big Block

MD2425 1965-67 w/o AC	44.99 set
MD2427 1967-74 w/o AC	44.99 set



MD2429

1964-71 Alternator Brackets

Each set is complete and includes bracket, spacers and bolts. Fits 1964-71 Hemi engines. Unpainted unless noted.

Note: Painted.
With Water Pump #2205862, 2468007 or 25366767

MD2430 1964-66	31.99 set
MD2429 1964-66	34.99 set
With Water Pump #2780987 or #698468	
MD2431 1964-66	31.99 set
MD2432 1967-71	34.99 set



T9456

Alternator Bracket Sets

Replacement triangle bracket and slider bracket. Triple chrome plated steel construction as original. Features a 1 year manufacturer's warranty.

T9456 small block	19.99 set
T9457S big block	24.99 set



MD2421

1966-74 Alternator Brackets

Reproduction alternator brackets for 1966-74 Mopar models with big block engines.

MD2421 triangle	24.99 ea
MD2422 main	31.99 ea
MD2423 swing arm	75.99 ea



Made in USA

1966-74 Alt. Bracket

Reproduction alternator slider bracket. Use and install on all 1966-74 Mopar V8 engines except Hemi. Made in USA. MD4067 except Hemi... 9.99 ea



Made in USA

1962-74 Alt. Bracket

Replacement alternator mounting triangle bracket for 1962-66 Mopar models equipped with a big block or Hemi but not equipped with AC. Each will replace the original exactly for a like factory appearance. Made in USA. MD2434 1962-66 w/o AC... 24.99 ea MD2433 1967-74 w/o AC... 24.99 ea



MD2437

Alternator Bolt & Spacer Kits

Each kit includes bolts, washers and spacers needed to mount the alternator and bracket.

*Note: *With 3-hole alternator bracket.*

Must use #MD2424 with this kit.

1970-74 Small Block Engines

With Aluminum Water Pump

MD2435 w/o AC	16.99 kit
---------------	-----------

1960-76 Big Block Engines

With Iron Water Pump

MD2580 w/o AC	14.99 kit
---------------	-----------

B-Series

MD2438*	14.99 kit
---------	-----------

4-Hole Alt Bracket

MD2580	14.99 kit
--------	-----------

With Iron Water Pump

MD2437 w/AC	14.99 kit
-------------	-----------

B-Series, with Iron Water Pump

MD2436* w/AC	10.99 kit
--------------	-----------

1966-71 Alternator Spacers

Hemi alternator spacer kit which includes 3 spacers for correct alignment.

MD4068 1966	Hemi...	14.99 kit
MD4068 1967-71	Hemi...	14.99 kit

Stainless Alternator Spacers

This 304 stainless Mopar alternator spacer set fits between the alternator bracket and the block. Fits big block or small block. Made in USA.

MF1746	18.99 set
--------	-----------

Positive Wire Insulator

Plastic collar insulates the positive wire at the rear of the alternator.

MN1138 all alternators...	8.99 ea
---------------------------	---------

1966-74 Alt. Wiring Clip

Mounts to back of alternator to prevent smaller wires from coming in contact with moving parts. Includes mounting screw. Made in USA.

MN1137 3 finger clip...	6.99 ea
-------------------------	---------



US SPOUNTER

Alternator Shutdown Relay Set

This 250 amp solenoid will effectively handle alternator feedback from the highest amperage alternators. Eliminates engine run-on when the master disconnect is turned off.

Note: No further discounts apply.

50105	137.99 set
-------	------------



US SPOUNTER

Electrical Surge Protector

This device clips the voltage spikes at 14.5 volts to protect sensitive electrical accessories.

Note: No further discounts apply.

40030	21.99 ea
-------	----------

Starters

1962-76 Brand New Replacement Starters

This direct replacement starter is new and priced competitively against remanufactured starters. Designed to replace a worn out or inoperative original starter, these will install and function exactly as original. Available for 1962-76 A-body, B-body and E-body vehicles.



6 Cylinder

N17466	1964-69	170	114.99
N17466	1970-74	198	114.99
N17466	1962-76	225	114.99

8 Cylinder

N17466	1964-69	273	114.99
N17466	1962-76	318	114.99
N17466	1968-73	340	114.99
N17466	1971-76	360	114.99
N17466	1962-65	361	114.99
N17466	1964-71	383	114.99
N17466	1972-76	400	114.99
N17466	1965	413	114.99
N17466	1964-71	426	114.99
N17466	1966-76	440	114.99

1965-76 Powermaster Starters

Powermaster replacement starters for 1965-76 Mopar models. Each starter

includes a dyno sheet to show how well the starter you just bought performs. Choose between stock OEM or up to Ultra Torque rated for 250+ lb. ft. of torque. The torque output of a starter is the most important consideration. The starter must be able to spin the engine, and do it without overheating internally. Since there is no such thing as having too much torque (even on a street vehicle) a 200 ft. lb. starter will work for everyone. Speaking in general terms, a over 12:1 compression or higher engine should use a 200 ft. lb. starter. Engines up to 12:1 should use at least a 180 ft. lb. starter. 160 ft. lb. starters are good for engines up to 10.5:1

1965-76 OEM Style

MN2164	169.99
--------	--------

1965-76 PowerMax

MN2165	160 ft. lb. mini-starter, natural	179.99
--------	-----------------------------------	--------

1965-76 Mastertorque

MN2166	180 ft. lb. natural	184.99
--------	---------------------	--------

1965-76 XS Torque

MN2167	200 ft. lb. natural	229.99
MN2168	200 ft. lb. chrome	349.99

1965-76 Ultra Torque

MN2169	200 ft. lb. high speed, natural	329.99
MN2179	250 ft. lb. natural	279.99

1962-76 Lightweight Starters

These specially-designed starter motors with heavy-duty features for V8 applications need no adapters. Weighing approximately 7 lbs. complete, these units are lighter than the previous Mopar Performance lightweight starter and half the weight of the original 1960s-70s vintage production starter and one inch shorter.



Note: Many require header/exhaust/block modifications for some applications.
MN9903 1967-76 small block 199.99
MN9904 1962-74 426 Hemi/big block. 314.99

1960-76 Remanufactured Starters

Quality remanufactured starter motors. Tested to meet or exceed factory specifications, each starter will install and function exactly as original.



Applications are available for 1960-76 A-body, B-body and E-body vehicles. 3248

6 Cylinder

3472	1961-64	170	2 bolt	169.99
3250	1964-69	170		69.99
3250	1970-72	198	exc. 3-speed	69.99
3248	1970-72	198	3-speed MT	79.99
3250	1973-74	198		69.99
3472	1960-61	225		169.99
3250	1962-76	225		69.99

8 Cylinder

3250	1964-69	273		69.99
3248	1966-67	273		79.99
3250	1962-76	318	3 bolt	69.99
3250	1968-73	340		69.99
3258	1974-76	360	high torque	69.99
3250	1974-76	360		69.99

Big Block V8

3250	1962-65	361		69.99
3258	1964-73	383	high torque	69.99
3250	1966-71	383		69.99
3258	1972-76	400		69.99
3258	1964-71	426	high torque	69.99
3250	1965-67	426		69.99
3258	1966-76	440		69.99

MSD DynaForce Starters

These MSD DynaForce starters

are designed for severe duty, high compression applications. The 3.4 hp motor uses a 4.4:1 gear reduction to easily start even an 18:1 small block or big block engine with a lower current draw than traditional starters. Features a red powder coat and natural finish. Made in USA.

Note: No further discounts apply.

5098	small block/ big block starter	274.99
------	--------------------------------	--------



Remote Control Starter Switch

Use to bypass the ignition

switch on any engine with solenoid starter switch. Lets

you crank the engine while working in the engine compartment. Includes 44" long leads. Connect from the positive terminal of the battery to the energizing terminal of solenoid. Use for generator, starter, electrical tests, setting ignition points, fuel pump tests, adjusting tappets and compression tests
Y20750 19.99

Wire Tester Spark Plug Wire Tester

When you want to quickly locate faulty plug wires, you need this tester. Now you can check spark plug wires without piercing or ruining the wires. If the light flashes, you have a sound and intact wire. If not it's time to replace.
Y26900 11.99



1970-74 E-Body Starter Heat Shield

Plastic starter shield which mounts to the frame and guards the starter on models equipped with AT. Commonly broken or missing.
ME1664 1970-74 134.00 ea



1962-65 Starter Splash Shield

Starter splash shields for 1962-65 B-Body models. Protects the starter from dust, water and other elements. Made in USA.
MB2216 1962-65 17.99 pr



1968-74 Starter Dust Shield

Replacement dust shield which mounts between the starter and bellhousing.
MD2366 1968-74 9.99 ea



1964-74 Starter Mounting Hardware

Each set the proper mounting hardware needed for 1964-74 models with a V8 engine, 1966-69 Hemi automatic transmission models, and 1966-69 426 Hemi models with a direct drive starter and manual transmission. Made in USA.

For All V8's & 1966-69 Hemi w/AT
MD2368 1964-74 8.99 set
For Direct Drive Starter on 426 Hemi w/MT
MD2367 1966-69 direct drive 6.99 set



AUTHORIZED

1962-74 Starter Relays

Replacement starter relays for all 1962-74 models. These relays mount on the inner fender near the battery.
209560 1962-65 models with AT 9.99
209560 1962-65 starter relay MT 8.99
244442 1966-74 exc. 1964-69 w/MT 8.99
244453 1966-69 models with MT 8.99



1966-74 Starter Relay Shield

Black plastic shield which attaches to the starter relay to prevent accidental grounding of positive terminal. For 1970-74 E-body, 1966-74 B-body and select 1966-74 A-body models.
MD2365 1966-74 11.99 ea

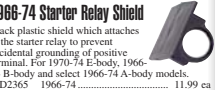

Remote Starter Solenoid

Position the starter solenoid any place you need in order to make maintenance easier. Includes extra wire and connectors.
Note: No further discounts apply.
30203 86.99 ea



Fuel Tanks

Dodge and Plymouth Fuel Tanks

These reproduction fuel tanks are manufactured to factory specifications from stamped steel and are available in a variety of finishes to suit your build. Basic zinc coated steel tanks are a great value, offering strong corrosion resistance at a reasonable price. Ni-terne steel tanks provide an OE-quality appearance for discerning restorers. For show-quality builds, stainless steel tanks offer superior corrosion resistance with a spectacular polished finish.

Zinc-Coated Fuel Tanks ★★★★★

- Quality Replacement Tank
- Standard Corrosion Resistance
- Manufactured to Factory Specifications



Ni-Terne Steel Fuel Tanks ★★★★★

- OE-Quality Reproduction Tank
- Exceptional Corrosion Resistance
- Manufactured to Factory Specifications



Stainless Steel Fuel Tanks ★★★★★

- Show-Quality Replacement Tank
- Superior Corrosion Resistance
- Stainless Steel Polished Finish
- Manufactured to Factory Specifications



New! OE QUALITY AUTHORIZED



1963-76 A-Body Fuel Tanks

These replacement fuel tanks for 1963-76 A-Body models are designed for an original appearance and fit. These tanks are available manufactured from aftermarket zinc coated steel, Ni-Terne steel as original or stainless steel. Lock ring and gasket are included.

Note: Shipped double oversize.

Zinc Coated Steel			
FT6000A	1963	18 gallons, with 2" filler hole	109.99 ea
FT6001A	1964-66	18 gallons, with 2" filler hole	109.99 ea
FT6002B	1967	18 gallons, with 2-1/4" filler hole	109.99 ea
FT6003A	1968-70	18 gallons, without vent pipe	109.99 ea
FT6004A	1970-71	16 gallons, with 4 vent pipe (side)	109.99 ea
FT6005A	1971-76	16 gallons, with 1 vent pipe (front)	109.99 ea
Original Ni-Terne Steel			
FT6000B	1963	18 gallons	199.99 ea
FT6001B	1964-66	18 gallons, with 2" filler hole	199.99 ea
FT6002B	1967	18 gallons, with 2-1/4" filler hole	199.99 ea
FT6003B	1968-70	18 gallons, without vent pipe	199.99 ea
FT6004B	1970-71	16 gallons, with 4 vent pipes (side)	199.99 ea
FT6005B	1971-76	16 gallons, with 1 vent pipe (front)	199.99 ea
Stainless Steel			
FT6005C	1971-76	16 gallons, with 1 vent pipe (front)	249.99 ea

New!



OE QUALITY AUTHORIZED

1962-73 B-Body Fuel Tanks

These replacement fuel tanks for 1962-73 B-Body models are designed for an original appearance and fit. These tanks are available manufactured from aftermarket zinc coated steel, Ni-Terne steel as original or stainless steel. Lock ring and gasket are included.

Note: Shipped double oversize.

Zinc Coated Steel			
FT6006A	1962-63	all	15 gallons 149.99 ea
FT6007A	1964-65	all	15 gallons 149.99 ea
FT6008A	1966-67	all	19 gallons 129.99 ea
FT6009A	1968-70	Charger	19 gallons, without EEC 129.99 ea
FT6010A	1970	Charger	19 gallons, 4 vent pipes (side) 129.99 ea
FT6011A	1968-70	exc Charger	19 gallons, 2 vent pipes (front) 129.99 ea
FT6012A	1970	exc Charger	19 gallons, 4 vent pipes (side) 129.99 ea
FT6013A	1971-72	before 4/72	19 gallons, 4 vent pipes (side) 169.99 ea
FT6014A	1972-73	after 4/72	19 gallons, 4 vent pipes (front) 169.99 ea
Original Ni-Terne Steel			
FT6006B	1962-63	all	15 gallons 199.99 ea
FT6007B	1964-65	all	15 gallons 199.99 ea
FT6008B	1966-67	all	19 gallons 199.99 ea
FT6009B	1968-70	Charger	19 gallons, without EEC 199.99 ea
FT6010B	1970	Charger	19 gallons, 4 vent pipes (side) 199.99 ea
FT6011B	1968-70	exc Charger	19 gallons, 2 vent pipes (front) 199.99 ea
FT6012B	1970	exc Charger	19 gallons, 4 vent pipes (side) 199.99 ea
FT6013B	1971-72	before 4/72	19 gallons, 4 vent pipes (side) 199.99 ea
FT6014B	1972-73	after 4/72	19 gallons, 4 vent pipes (front) 199.99 ea

Stainless Steel			
FT6007C	1964-65	all	15 gallons 249.99 ea
FT6008C	1966-67	all	19 gallons 249.99 ea
FT6009C	1968-70	Charger	19 gallons, without EEC 249.99 ea
FT6011C	1968-70	exc Charger	19 gallons, 2 vent pipes (front) 249.99 ea

New!



OE QUALITY AUTHORIZED

1970-74 E-Body Fuel Tanks

These fuel tanks for 1970-74 E-Body models are designed for an original appearance and fit. These tanks are available manufactured from aftermarket zinc coated steel, Ni-Terne steel as original or stainless steel. Lock ring and gasket are included.

Note: Shipped double oversize.

1970-74 Dodge Challenger

Zinc Coated Steel			
FT6015A	1970	all	18 gallons, without vent pipe 124.99 ea
FT6016A	1971-72	before 4/72	18 gallons, 4 vent pipes (side) 124.99 ea
FT6017A	1972-74	after 4/72	18 gallons, 4 vent pipes (front) 124.99 ea

Original Ni-Terne Steel			
FT6015B	1970	all	18 gallons, without vent pipe 199.99 ea
FT6016B	1971-72	before 4/72	18 gallons, 4 vent pipes (side) 199.99 ea
FT6017B	1972-74	after 4/72	18 gallons, 4 vent pipes (front) 199.99 ea

Stainless Steel			
FT6015C	1970	all	18 gallons, without vent pipe 249.99 ea
FT6016C	1971-72	before 4/72	18 gallons, 4 vent pipes (side) 249.99 ea
FT6017C	1972-74	after 4/72	18 gallons, 4 vent pipes (front) 249.99 ea

1970-74 Plymouth Barracuda

Zinc Coated Steel			
FT6018A	1970	all	18 gallons, 1 vent pipe (side) 109.99 ea
FT6019A	1971-72	before 4/72	18 gallons, 4 vent pipes (side) 124.99 ea
FT6020A	1972-74	after 4/72	18 gallons, 4 vent pipes (front) 124.99 ea

Original Ni-Terne Steel			
FT6018B	1970	all	18 gallons, 1 vent pipe (side) 199.99 ea
FT6019B	1971-72	before 4/72	18 gallons, 4 vent pipes (side) 199.99 ea
FT6020B	1972-74	after 4/72	18 gallons, 4 vent pipes (front) 199.99 ea

Stainless Steel			
FT6018C	1970	all	18 gallons, 1 vent pipe (side) 249.99 ea
FT6019C	1971-72	before 4/72	18 gallons, 4 vent pipes (side) 249.99 ea
FT6020C	1972-74	after 4/72	18 gallons, 4 vent pipes (front) 249.99 ea

FUEL & EXHAUST

Fuel Tank Components

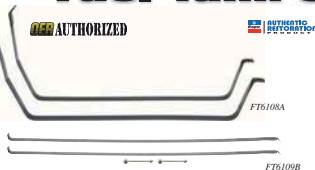

1962-76 Fuel Tank Straps

Replace the rusty original straps with these new fuel tank straps for 1962-76 A, B and E-Body models. If you are replacing your fuel tank, new straps are a must! Available in standard steel or stainless steel. Some stainless steel straps are available with or without hardware.

Note: 1962-67 use one strap; 1968-76 use two straps.

1962-76 Standard Steel Fuel Tank Straps

FT6107A	1963-66	A-Body	29.99	pr
FT6102A	1967	A-Body	29.99	ea
FT6103A	1968-76	A-Body	29.99	pr
FT6104A	1962-65	B-Body	29.99	ea
FT6106A	1968-70	B-Body	29.99	pr
FT6107A	1971-73	B-Body	29.99	pr
FT6108A	1970-74	E-Body	29.99	pr

1962-76 Stainless Steel Fuel Tank Straps

FT6101B	1963-66	A-Body	39.99	ea
FT6102B	1967	A-Body	39.99	ea
FT6103B	1968-76	A-Body	39.99	pr
FT6104B	1962-65	B-Body	39.99	ea
FT6105B	1966-67	B-Body	39.99	ea
FT6106B	1968-70	B-Body	39.99	pr
FT6107B	1971-73	B-Body	39.99	pr
FT6108B	1970-74	E-Body	34.99	pr

1968-74 Stainless Steel Fuel Tank Straps - With Hardware

FT6109B	1968-70	B-Body	54.99	set
FT6110B	1970-74	E-Body	54.99	set



MF24S



MF250

1962-76 Fuel Tank Insulator Pads

Replacement fuel tank insulator pad, manufactured using die-cut rubber and installs on top of the tank between the fuel tank and body to guard against vibration and prevent rattling. Available for a variety of 1962-76 A-Body, B-Body and E-Body vehicles. Made in USA.

A-Body				
MF237	1964-66	die-cut rubber pad	19.99	ea
MF238	1967-76	die-cut rubber pad	19.99	ea
B-Body				
MF244	1962-65	die-cut rubber pad	22.99	ea
MF245	1966-67	die-cut rubber pad	19.99	ea
MF246	1968-70	die-cut rubber pad	19.99	ea
MF247	1971-74	die-cut rubber pad	19.99	ea
E-Body				
MF250	1970-74	die-cut rubber pad	19.99	ea



1968-74 A, B & E-Body Fuel Tank Mounting Studs

Fuel tank mounting strap studs needed when replacing your fuel tank straps for all 1968-74 A, B & E-Body models. Made from steel. Measures 3/8"-16 x 4".
 MMS271 1966-74 fuel tank straps..... 11.99 pr



MF46002A

1964-74 Aluminum Fuel Tanks

Replacement-style aluminum fuel tanks for 1964-74 Mopar models. These fuel tanks are manufactured in the USA from .090 gauge 5052 aluminum, TIG welded by hand and pressure checked before shipping. All tanks are fully baffled; uses stock mounting and fuel filler tube for easy installation in the stock location. Available for carbureted or fuel injection equipped vehicles and with or without vent tubes for emissions.

Important: All fuel tanks include a 11-78 ohm fuel sending unit for use with stock gauges. Fuel injected tanks include an in-tank fuel pump.

Note: Special order; must be pre-paid. Shipped overseas.

		Carbureted		
A-Body				
MF46001A	1964-67	all	19.9 Gallons, 1 strap.....	559.99 ea
MF46001C	1964-67	all	squared, 1 strap.....	559.99 ea
MF46002A	1967-69	Barracuda	19.9 Gal, 2 straps, w/o vents	609.99 ea
MF46002B	1967-69	Barracuda	19.9 Gal, 2 straps, w/vents	559.99 ea
MF46002C	1967-69	Barracuda	squared, 2 straps, w/o vents	559.99 ea
MF46003A	1968-74	all,exc. B'c'da	19.9 Gal, 2 straps, w/o vents	559.99 ea
MF46003B	1968-74	all,exc. B'c'da	19.9 Gal, 2 straps, w/vents	559.99 ea
MF46003C	1968-74	all,exc. B'c'da	squared, 2 straps, w/o vents	559.99 ea
B-Body				
MF46004A	1966-67	all	22 Gallons, 1 strap.....	609.99 ea
MF46004C	1966-67	all	squared, 1 strap.....	609.99 ea
MF46005	1968-70	all, exc. Chrg	22 Gallons, 2 straps	609.99 ea
MF46006	1968-70	Charger	22 Gallons, 2 straps	609.99 ea
E-Body				
MF46007A	1970-74	Barracuda	19.9 Gal, 2 straps, w/o vents	559.99 ea
MF46007B	1970-74	Barracuda	19.9 Gal, 2 straps, w/vents	559.99 ea
MF46008A	1970-74	Challenger	19.9 Gal, 2 straps, w/o vents	559.99 ea
MF46008B	1970-74	Challenger	19.9 Gal, 2 straps, w/vents	559.99 ea

Fuel Injection - Includes In-Tank Fuel Pump

A-Body				
MF46009A	1964-67	all	19.9 Gal, 1 strap.....	1069.99 ea
MF46009C	1964-67	all	squared, 1 strap.....	1069.99 ea
MF46010A	1967-69	Barracuda	19.9 Gal, 2 straps, w/o vents	1069.99 ea
MF46010B	1967-69	Barracuda	19.9 Gal, 2 straps, w/vents	1069.99 ea
MF46010C	1967-69	Barracuda	squared, 2 straps, w/o vents	1069.99 ea
MF46011A	1968-74	all,exc. B'c'da	19.9 Gal, 2 straps, w/o vents	1069.99 ea
MF46011B	1968-74	all,exc. B'c'da	19.9 Gal, 2 straps, w/vents	1069.99 ea
MF46011C	1968-74	all,exc. B'c'da	squared, 2 straps, w/o vents	1069.99 ea
B-Body				
MF46012A	1966-67	all	22 Gallons, 1 strap.....	1109.99 ea
MF46012C	1966-67	all	squared, 1 strap.....	1109.99 ea
MF46013	1968-70	all, exc. Chrg	22 Gallons, 2 straps	1069.99 ea
MF46014	1968-70	Charger	22 Gallons, 2 straps	1069.99 ea
E-Body				
MF46015A	1970-74	Barracuda	19.9 Gal, 2 straps, w/o vents	1059.99 ea
MF46015B	1970-74	Barracuda	19.9 Gal, 2 straps, w/vents	1059.99 ea
MF46016A	1970-74	Challenger	19.9 Gal, 2 straps, w/o vents	1059.99 ea
MF46016B	1970-74	Challenger	19.9 Gal, 2 straps, w/vents	1059.99 ea

Replacement Fuel Sending Units for Fuel Tanks

MF46501	1966-74	A-Body	all, 11-78 ohms	51.99 ea
MF46502	1966-67	B-Body	all, 11-78 ohms	51.99 ea
MF46503	1968-70	B-Body	all, 11-78 ohms	51.99 ea
MF46504	1970-74	E-Body	all, 11-78 ohms	51.99 ea

Replacement Gas Caps

New!

OE AUTHORIZED
RESTORATION



1963-75 Filler Neck Grommets

Eliminate vapor or fuel leaks with these officially licensed Mopar Authentic Restoration Product grommets. These grommets seal the area where the steel filler neck attaches to the fuel tank. Officially licensed Mopar Authentic Restoration Products.

1963-75 A-Body

MF295	1963-66	1-3/4" ID.....	14.99 ea
MF369	1963-66	1-1/2" ID.....	14.99 ea
MF296	1967-74		14.99 ea
MF297	1975		14.99 ea

1964-74 B-Body

B-Body Except Wagon			
MF296	1964-69		14.99 ea
MF297	1970-71		14.99 ea
MF296	1972-74		14.99 ea

B-Body Wagon			
MF295	1964-65		14.99 ea
MF296	1966-68		14.99 ea
MF296	1970		14.99 ea

1970-74 E-Body

MF297	1970-74		14.99 ea
-------	---------	--	----------

New!

OE AUTHORIZED
RESTORATION



1968-76 Fuel Tank Filler Neck

Replace your damaged or missing filler with this new fuel tank filler necks.

OE Authorized
 MF2242 1968-70 B-Body exc Charger 59.99 ea
 ME8150 1970-74 Barracuda..... 49.99 ea

Reproduction			
MF46200	1970-71	A-Body.....	79.99 ea
MF46201	1973-76	Duster.....	79.99 ea
MF46201	1973-76	Dart Sport.....	79.99 ea
MF46202	1971-74	Charger.....	79.99 ea
MF46203	1973-74	Roadrunner.....	79.99 ea

OE AUTHORIZED

RESTORATION



1968-70 B-Body Non-Locking Gas Cap

Correct reproduction gas cap for 1968-70 B-Body vehicles including Dodge Coronet, Plymouth Belvedere and Plymouth Satellite models. This is a non-locking and non-vented gas cap that is for both 6 cylinder and V8 models.

15137	1968-70		49.99 ea
-------	---------	--	----------

OE AUTHORIZED

RESTORATION



1967-74 Quick-Fill Fuel Caps

These "Quick-Fill" fuel caps and trim rings are available for a variety of 1967-74 models.

Quick-Fill Fuel Caps

Barracuda			
MF363	1967-68		89.99 ea
MF362	1969		89.99 ea
Charger			
MF363	1968		89.99 ea
MF362	1969-70		89.99 ea
GTX			
MF363	1967		89.99 ea
Challenger			
MF365	1970-74	with trim ring.....	114.99 ea
MF367	1970-74	w/o trim ring.....	94.99 ea

Quick-Fill Fuel Cap Trim Rings

Charger	MF364	1968-70	35.99 ea
Challenger	MF366	1970-74	19.99 ea

New!

OE AUTHORIZED
RESTORATION



1960-74 Fuel Tank Caps

Reproduction fuel tank caps for 1960-74 models. Manufactured as original, these vented caps come with a primer finish or chrome plated.

Chrome
 MP71004 1960-66 A-Body non-vented. 89.99 ea
 MAS174 1967-71 A-Body non-vented. 35.99 ea

Primer
 MF71005 1960-66 A-Body non-vented. 59.99 ea
 MAS173 1967-71 A-Body non-vented. 29.99 ea
 MF368 1967-76 A-Body vented..... 39.99 ea
 ME1756 1970-71 Challenger..... 29.99 ea
 ME1757 1972-74 Challenger..... 29.99 ea

New!

ridetech



Universal Billet Fuel Filler Assemblies

These billet fuel filler assemblies are made from machined aluminum they offer OEM quality sealing. An optional vent kit is also available for applications where venting is required.

81000034	clear anodized	209.99 ea
81000036	black anodized	219.99 ea
81000038	vent kit	9.99 ea



1960-76 Replacement Locking and Non-Locking Fuel Caps

Replace your old, damaged or missing fuel cap with a new, replacement fuel cap or protect your vehicle from vandalism and theft with a locking fuel cap. Available for most A-Body, B-Body and E-Body vehicles.

*Note: No fuel caps available for 1970 California vehicles except as noted. *Replacement wagon.*

Stant Replacement Fuel Caps

A-Body			
ST10800	1971-76	all from May 1971	9.99 ea
B-Body			
ST10646*	1960-62	Dodge.....	6.99 ea
ST10646	1960-65	Plymouth.....	6.99 ea
ST10646*	1962-64	Fury, Polara.....	6.99 ea
ST10646*	1965-67	Coronet.....	6.99 ea
ST10646	1966-67	Charger.....	6.99 ea
ST10632*	1968-70	all.....	4.99 ea
ST10806	1970	all CA cars.....	4.99 ea
ST10806	1971	all pre April 1971	4.99 ea
ST10807	1971-74	all from May 1971	4.99 ea
E-Body			
MF235	1970	Cuda exact replace.....	74.99 ea
ST10623	1970	Cuda service replace	7.99 ea
ST10806	1971	Cuda pre-April 1971	4.99 ea

Stant Locking Fuel Caps

A-Body			
ST10572	1967-70	all exc 1970 CA.....	14.99 ea
ST10572	1971-76	all from May 1971	14.99 ea
B-Body			
ST10492*	1960-62	Dodge.....	11.99 ea
ST10492*	1961-65	Plymouth.....	11.99 ea
ST10492*	1962-64	Fury, Polara.....	11.99 ea
ST10492*	1965-67	Coronet.....	11.99 ea
ST10492	1966-67	Charger all.....	11.99 ea
ST10483	1966-67	Belvedere all.....	12.99 ea
ST10483	1967	Satellite all.....	12.99 ea
ST10571*	1968-70	Plymouth.....	14.99 ea
ST10571*	1968-70	Coronet.....	14.99 ea
ST10583	1970	all CA cars.....	14.99 ea
ST10583	1971	all pre April 1971	14.99 ea
ST10571	1971-74	all from May 1971	14.99 ea
E-Body			
ST10491	1970	Cuda exc CA.....	11.99 ea
ST10583	1971	Cuda pre April 1971	14.99 ea
ST10571	1971-74	Cuda post May 1971	14.99 ea
ST10571	1974	Challenger all.....	14.99 ea

Fuel Pump to Carburetor Lines

Each line is manufactured using a precision process that creates the exact same bends as factory original equipment. Couple these exact manufacturing techniques with superior material selection and you can be sure that you are installing the best fuel lines on the market. These lines are produced in your choice of original steel material or stainless steel material for A, B or E-Body models without the hassle of bending your own lines.

Note: *Includes one brass tee.



MF565A

1964-74 A-Body Fuel Lines

Original Material Pump to Carb Lines		
MF560A	1964	273, 2 bbl
MF561A	1964	Slant 6, 225
MF562A	1965	383 w/Carter AVS 4 bbl
MF563A	1967	383 w/Carter AFB 4 bbl
MF564A	1966	273 c, 2 bbl
MF565A	1967-72	318, 2 bbl (used w/inline filter)
MF567A	1967	273, 2 bbl
MF571A	1968-69	383 w/Carter AFB 4 bbl
MF572A	1968-71	383 w/Carter AVS 4 bbl
MF573A	1969-71	340 w/Thermo-Quad 4 bbl
MF574A	1967-72	383 w/Carter AVS 4 bbl
MF575A	1967-72	383 w/single inlet Holley
MF576A	1969	Slant 6, 225
MF577A	1971-72	318, 2 bbl
MF578A	1971	340 w/Thermo-Quad 4 bbl
MF579A	1972	340 w/Thermo-Quad 4 bbl
MF580A	1973	340 w/Thermo-Quad 4 bbl
MF581A	1974	318, 2 bbl

Stainless Steel Pump to Carb Lines		
MF560B	1964	273, 2 bbl
MF561B	1964	Slant 6, 225
MF562B	1965	383 w/Carter AVS 4 bbl
MF563B	1967	383 w/Carter AFB 4 bbl
MF564B	1966	273 c, 2 bbl
MF565B	1967-72	318, 2 bbl (used w/inline filter)
MF567B	1967	273, 2 bbl
MF571B	1968-69	383/440 w/Carter AFB 4 bbl
MF572B	1968-71	383 w/Carter AVS 4 bbl
MF573B	1969-71	340 w/Thermo-Quad 4 bbl
MF574B	1967-72	383 w/Carter AVS 4 bbl
MF575B	1967-72	383 w/single inlet Holley
MF576B	1969	Slant 6, 225
MF577B	1971-72	318, 2 bbl
MF578B	1971	340 w/Thermo-Quad 4 bbl
MF579B	1972	340 w/Thermo-Quad 4 bbl
MF580B	1973	340 w/Thermo-Quad 4 bbl
MF581B	1974	318, 2 bbl

1960-75 B-Body Fuel Lines

Original Material Pump to Carb Lines		
MF582A	1960	383, 2-4 BBL
MF583A	1960-63	413, 4 bbl
MF584A	1962-63	Max Wedge w/3447 carbs
MF585A	1963-64	Max Wedge w/3705 carbs 5/16"
MF561A	1964	Slant 6, 225
MF586A	1964-65	426 Street Wedge, 1 4 BBL, #3611 S
MF587A	1964-65	383 w/Carter AFB
MF588A	1964-65	Hemi Cross-Ram w/Carter carbs*
MF589A	1964-68	Hemi Cross-Ram w/Holley carbs*
MF563A	1966-67	383/440 w/Carter AFB 4 bbl
MF566A	1966-67	426 Hemi (tee, hoses, & clamps)
MF566A	1967	225 slant 6
MF565A	1967-72	318, 2 bbl (used w/inline filter)
MF574A	1967-72	383 w/Carter AVS 4 bbl
MF575A	1967-72	383, 440 w/single inlet Holley
MF571A	1968-69	383/440 w/Carter AFB 4 bbl
MF591A	1968-70	383 w/factory Holley 4 bbl
MF572A	1968-71	383 w/Carter AVS 4 bbl
MF592A	1968-71	426 Hemi (bracket, tee, & fittings)
MF568A	1969-71	Six Pack, upper set (w/2 brass tees)
MF570A	1969-71	440, Six Pack, lower line set
MF573A	1969-71	340 w/Carter AVS 4 bbl
MF595A	1970-71	440, w/Carter Thermo-Quad 4 bbl
MF577A	1971-72	318, 2 bbl
MF578A	1971	340 w/Thermo-Quad 4 bbl
MF579A	1972	340 w/Thermo-Quad 4 bbl
MF593A	1972	440 w/Carter AVS 4 bbl
MF580A	1973	340 w/Thermo-Quad 4 bbl
MF581A	1974	318, 2 bbl
MF581A	1975	360, 2 bbl

Stainless Steel Pump to Carb Lines		
MF582B	1960	383, 2-4 BBL
MF583B	1960-63	413, 4 bbl
MF584B	1962-63	Max Wedge w/3447 carbs
MF585B	1963-64	Max Wedge w/3705 carbs 5/16"
MF561B	1964	Slant 6, 225
MF586B	1964-65	426 Street Wedge, 1 4 BBL, #3611 S
MF587B	1964-65	383 w/Carter AFB
MF588B	1964-65	Hemi Cross-Ram w/Carter carbs*
MF589B	1964-68	Hemi Cross-Ram w/Holley carbs*
MF563B	1966-67	383/440 w/Carter AFB 4 bbl
MF566B	1966-67	426 Hemi (tee, hoses, & clamps)
MF566B	1967	225 slant 6
MF565B	1967-72	318, 2 bbl (used w/inline filter)
MF574B	1967-72	383 w/Carter AVS 4 bbl
MF575B	1967-72	383, 440 w/Holley 4 bbl
MF571B	1968-69	383/440 w/Carter AFB 4 bbl
MF591B	1968-70	383 w/factory Holley 4 bbl
MF572B	1968-71	383 w/Carter AVS 4 bbl
MF592B	1968-71	426 Hemi (bracket, tee, & fittings)
MF568B	1969-71	Six Pack, upper set (w/2 brass tees)
MF570B	1969-71	440, Six Pack, lower line set
MF573B	1969-71	340 w/Carter AVS 4 bbl
MF595B	1970-71	440, w/Carter Thermo-Quad 4 bbl
MF577B	1971-72	318, 2 bbl
MF578B	1971	340 w/Thermo-Quad 4 bbl
MF579B	1972	340 w/Thermo-Quad 4 bbl
MF593B	1972	440 w/Carter AVS 4 bbl
MF580B	1973	340 w/Thermo-Quad 4 bbl
MF581B	1974	318, 2 bbl
MF581B	1975	360, 2 bbl

1970-74 E-Body Fuel Lines

Original Material Pump to Carb Lines		
MF565A	1970-72	318, 2 bbl (used w/inline filter)
MF568A	1970-71	Six Pack, upper set (w/2 brass tees)
MF569A	1970-71	340, Six Pack, lower line set
MF570A	1970-71	440, Six Pack, lower line set
MF592A	1970-71	426 Hemi (bracket, tee, & fittings)
MF572A	1970-71	383 w/Carter AVS 4 bbl
MF591A	1970-71	383 w/factory Holley 4 bbl
MF572A	1970-71	383 w/Carter AVS 4 bbl
MF573A	1970-71	340 w/Carter AVS 4 bbl
MF595A	1970-71	440, w/Carter Thermo-Quad 4 bbl
MF574A	1970-72	383 w/Carter AVS 4 bbl
MF575A	1970-72	383, 440 w/single inlet Holley
MF577A	1971-72	318, 2 bbl
MF578A	1971	340 w/Thermo-Quad 4 bbl
MF579A	1972	340 w/Thermo-Quad 4 bbl
MF593A	1972	440 w/Carter AVS 4 bbl
MF580A	1973-74	340 w/Thermo-Quad 4 bbl
MF581A	1974	318, 2 bbl

Stainless Steel Pump to Carb Lines		
MF565B	1970-72	318, 2 bbl (used w/inline filter)
MF568B	1970-71	Six Pack, upper set (w/2 brass tees)
MF569B	1970-71	340, Six Pack, lower line set
MF570B	1970-71	440, Six Pack, lower line set
MF592B	1970-71	426 Hemi (bracket, tee, & fittings)
MF572B	1970-71	383 w/Carter AVS 4 bbl
MF591B	1970-71	383 w/factory Holley 4 bbl
MF572B	1970-71	383 w/Carter AVS 4 bbl
MF573B	1970-71	340 w/Carter AVS 4 bbl
MF595B	1970-71	440, w/Carter Thermo-Quad 4 bbl
MF574B	1970-72	383 w/Carter AVS 4 bbl
MF575B	1970-72	383, 440 w/single inlet Holley
MF577B	1971-72	318, 2 bbl
MF578B	1971	340 w/Thermo-Quad 4 bbl
MF579B	1972	340 w/Thermo-Quad 4 bbl
MF593B	1972	440 w/Carter AVS 4 bbl
MF580B	1973-74	340 w/Thermo-Quad 4 bbl
MF581B	1974	318, 2 bbl

Fuel Lines

Replace Your Fuel Lines With OEM Material For Originality Or High Quality, Long Lasting, Stainless Steel Material!



Each line is manufactured using a precision manufacturing process that creates the correct bends to match the factory original equipment. Couple these manufacturing techniques with your choice of material selection and you can be assured that you are installing the best fuel lines on the market. These lines are available for many A, B, or E-Body applications, saving you the hassle of having to bend up your own fuel lines.

Note: All fuel lines are shipped double oversize.

1963-75 A-Body Front to Rear Fuel Lines

Applications are available for 1963-75 A-Body vehicles including 1964-69 Barracuda, 1963-75 Dart, Valiant, 1971-74 Demon/Dart Sport, Duster and Scamp.

Original Material Fuel Lines			
Barracuda			
MF500A	1964-66	5/16" main fuel line	1 line..... 58.99 ea
MF501A	1964-66	3/8" main fuel line	1 line..... 58.99 ea
MF502A	1967-68	5/16" main fuel line	1 line..... 58.99 ea
MF503A	1967-68	3/8" main fuel line	1 line..... 58.99 ea
MF504A	1969	5/16" main fuel line	1 line..... 58.99 ea
MF505A	1969	3/8" main fuel line	1 line..... 58.99 ea
Dart			
MF506A	1963	5/16" main fuel line	1 line..... 58.99 ea
MF500A	1964-66	5/16" main fuel line	1 line..... 58.99 ea
MF501A	1964-66	3/8" main fuel line	1 line..... 58.99 ea
MF507A	1967-68	5/16" main fuel line	1 line..... 58.99 ea
MF508A	1967-68	3/8" main fuel line	1 line..... 58.99 ea
MF509A	1969-72	5/16" main fuel line	1 line..... 58.99 ea
MF510A	1969-72	3/8" main fuel line	1 line..... 58.99 ea
MF511A	1972	1/4" return line	2 lines..... 58.99 set
MF512A	1972-74	5/16" main fuel line	1 line..... 58.99 ea
MF513A	1973-74	3/8" main fuel line	1 line..... 58.99 ea
MF514A	1975	Swinger, main fuel line	1 line..... 58.99 ea
MF515A	1975	Swinger, return line	1 line..... 58.99 ea
Demon/Dart Sport			
MF505B	1971	3/8" main fuel line	1 line..... 58.99 ea
MF516A	1971	5/16" vapor line	2 lines..... 58.99 set
MF511A	1972	1/4" return line	2 lines..... 58.99 set
MF517A	1973-74	5/16" main fuel line	1 line..... 58.99 ea
MF518A	1973-74	3/8" main fuel line	1 line..... 58.99 ea
Duster			
MF504A	1970-72	5/16" main fuel line	1 line..... 58.99 ea
MF505A	1970-72	3/8" main fuel line	1 line..... 58.99 ea
MF519A	1972	5/16" vapor line	2 lines..... 58.99 set
MF511A	1972	1/4" return line	2 lines..... 58.99 set
MF517A	1973-74	5/16" main fuel line	1 line..... 58.99 ea
MF518A	1973-74	3/8" main fuel line	1 line..... 58.99 ea
Scamp			
MF520A	1971	5/16" vapor line	2 lines..... 58.99 set
MF511A	1972	1/4" return line	2 lines..... 58.99 set
MF512A	1972-74	5/16" main fuel line	1 line..... 58.99 ea
MF521A	1972-73	5/16" vapor line	2 lines..... 58.99 set
Valiant			
MF500A	1964-66	5/16" main fuel line	1 line..... 58.99 ea
MF501A	1964-66	3/8" main fuel line	1 line..... 58.99 ea
MF502A	1967-68	5/16" main fuel line	1 line..... 58.99 ea
MF503A	1967-68	3/8" main fuel line	1 line..... 58.99 ea
MF504A	1969-72	5/16" main fuel line	1 line..... 58.99 ea
MF505A	1969-72	3/8" main fuel line	1 line..... 58.99 ea
MF511A	1972	1/4" return line	2 lines..... 58.99 set
MF517A	1973-74	5/16" main fuel line	1 line..... 58.99 ea
MF518A	1973-74	3/8" main fuel line	1 line..... 58.99 ea

Stainless Steel Fuel Lines			
Barracuda			
MF500B	1964-66	5/16" main fuel line	1 line..... 94.99 ea
MF501B	1964-66	3/8" main fuel line	1 line..... 94.99 ea
MF502B	1967-68	5/16" main fuel line	1 line..... 94.99 ea
MF503B	1967-68	3/8" main fuel line	1 line..... 94.99 ea
MF504B	1969	5/16" main fuel line	1 line..... 94.99 ea
MF505B	1969	3/8" main fuel line	1 line..... 94.99 ea
Dart			
MF506B	1963	5/16" main fuel line	1 line..... 94.99 ea
MF500B	1964-66	5/16" main fuel line	1 line..... 94.99 ea
MF501B	1964-66	3/8" main fuel line	1 line..... 94.99 ea
MF507B	1967-68	5/16" main fuel line	1 line..... 94.99 ea
MF508B	1967-68	3/8" main fuel line	1 line..... 94.99 ea
MF509B	1969-72	5/16" main fuel line	1 line..... 94.99 ea
MF510B	1969-72	3/8" main fuel line	1 line..... 94.99 ea
MF511B	1972	1/4" return line	2 lines..... 109.99 set
MF512B	1972-74	5/16" main fuel line	1 line..... 94.99 ea
MF513B	1973-74	3/8" main fuel line	1 line..... 94.99 ea
MF514B	1975	Swinger, main fuel line	1 line..... 94.99 ea
MF515B	1975	Swinger, return line	1 line..... 94.99 ea
Demon/Dart Sport			
MF505B	1971	3/8" main fuel line	1 line..... 94.99 ea
MF516B	1971	5/16" vapor line	2 lines..... 94.99 set
MF511B	1972	1/4" return line	2 lines..... 109.99 set
MF517B	1973-74	5/16" main fuel line	1 line..... 94.99 ea
MF518B	1973-74	3/8" main fuel line	1 line..... 94.99 ea
Duster			
MF504B	1970-72	5/16" main fuel line	1 line..... 94.99 ea
MF505B	1970-72	3/8" main fuel line	1 line..... 94.99 ea
MF519B	1972	5/16" vapor line	2 lines..... 94.99 set
MF511B	1972	1/4" return line	2 lines..... 109.99 set
MF517B	1973-74	5/16" main fuel line	1 line..... 94.99 ea
MF518B	1973-74	3/8" main fuel line	1 line..... 94.99 ea
Scamp			
MF520B	1971	5/16" vapor line	2 lines..... 94.99 set
MF511B	1972	1/4" return line	2 lines..... 109.99 set
MF512B	1972-74	5/16" main fuel line	1 line..... 94.99 ea
MF521B	1972-73	5/16" vapor line	2 lines..... 94.99 set
Valiant			
MF500B	1964-66	5/16" main fuel line	1 line..... 94.99 ea
MF501B	1964-66	3/8" main fuel line	1 line..... 94.99 ea
MF502B	1967-68	5/16" main fuel line	1 line..... 94.99 ea
MF503B	1967-68	3/8" main fuel line	1 line..... 94.99 ea
MF504B	1969-72	5/16" main fuel line	1 line..... 94.99 ea
MF505B	1969-72	3/8" main fuel line	1 line..... 94.99 ea
MF511B	1972	1/4" return line	2 lines..... 109.99 set
MF517B	1973-74	5/16" main fuel line	1 line..... 94.99 ea
MF518B	1973-74	3/8" main fuel line	1 line..... 94.99 ea

L FUEL & EXHAUST

Fuel Lines

Your Choice of OEM Material For Originality or Long-Lasting Stainless Steel!



1962-74 B-Body Front to Rear Fuel Lines

Applications are available for 1962-74 B-Body vehicles including 1962 Dodge Dart, Polara 500, 1963 Dodge 330, 440, Polara, Polara 500, 1962-64 Plymouth Savoy, Belvedere, Fury, Sport Fury, 1965 Belvedere, Satellite, 1966-74 Belvedere, Charger, Coronet, GTX, Road Runner, Satellite and Super Bee.

Note: All fuel lines are shipped double oversize.

Original Material Fuel Lines		#83	
B-Body Models			
MF522A	1962-63	5/16" main fuel line	1 line..... 58.99 ea
MF523A	1962-63	3/8" main fuel line	1 line..... 58.99 ea
MF524A	1962-65	Wagon, 5/16" main line	1 line..... 58.99 ea
MF525A	1964-65	5/16" main fuel line	1 line..... 58.99 ea
MF526A	1964-65	3/8" main fuel line	1 line..... 58.99 ea
MF527A	1966-67	5/16" main fuel line	1 line..... 58.99 ea
MF528A	1966-67	3/8" main fuel line	1 line..... 58.99 ea
MF529A	1966-67	Wagon, 5/16" main line	1 line..... 58.99 ea
MF530A	1968-69	5/16" main fuel line	1 line..... 58.99 ea
MF531A	1968-69	3/8" main fuel line	1 line..... 58.99 ea
MF532A	1968-69	1/4" return line	1 line..... 58.99 ea
MF533A	1970	5/16" main fuel line	1 line..... 58.99 ea
MF534A	1970	3/8" main fuel line	1 line..... 58.99 ea
MF535A	1970	1/4" return line	1 line..... 58.99 ea
MF536A	1970	5/16" ECS vapor line	1 line..... 58.99 ea
MF537A	1971	5/16" main fuel line	1 line..... 58.99 ea
MF538A	1971	3/8" main fuel line	1 line..... 58.99 ea
MF539A	1971	1/4" return line	1 line..... 58.99 ea
MF541A	1972	5/16" main fuel line	1 line..... 58.99 ea
MF542A	1972	3/8" main fuel line	1 line..... 58.99 ea
MF543A	1972	1/4" return line	1 line..... 58.99 ea
MF545A	1973	5/16" main fuel line	1 line..... 58.99 ea
MF546A	1973	1/4" return line	2 lines..... 58.99 set
MF547A	1974	3/8" main fuel line	1 line..... 58.99 ea
MF548A	1974	1/4" return line	1 line..... 58.99 ea
MF549A	1974	5/16" ECS vapor line	1 line..... 58.99 ea

Stainless Steel Fuel Lines		#83	
B-Body Models			
MF522B	1962-63	5/16" main fuel line	1 line..... 94.99 ea
MF523B	1962-63	3/8" main fuel line	1 line..... 94.99 ea
MF524B	1962-65	Wagon, 5/16" main line	1 line..... 94.99 ea
MF525B	1964-65	5/16" main fuel line	1 line..... 94.99 ea
MF526B	1964-65	3/8" main fuel line	1 line..... 94.99 ea
MF527B	1966-67	5/16" main fuel line	1 line..... 94.99 ea
MF528B	1966-67	3/8" main fuel line	1 line..... 94.99 ea
MF529B	1966-67	Wagon, 5/16" main line	1 line..... 94.99 ea
MF530B	1968-69	5/16" main fuel line	1 line..... 94.99 ea
MF531B	1968-69	3/8" main fuel line	1 line..... 94.99 ea
MF532B	1968-69	1/4" return line	1 line..... 94.99 ea
MF533B	1970	5/16" main fuel line	1 line..... 94.99 ea
MF534B	1970	3/8" main fuel line	1 line..... 94.99 ea
MF535B	1970	1/4" return line	1 line..... 94.99 ea
MF536B	1970	5/16" ECS vapor line	1 line..... 94.99 ea
MF537B	1971	5/16" main fuel line	1 line..... 94.99 ea
MF538B	1971	3/8" main fuel line	1 line..... 94.99 ea
MF539B	1971	1/4" return line	1 line..... 94.99 ea
MF540B	1971	5/16" ECS vapor line	2 lines..... 94.99 set
MF541B	1972	5/16" main fuel line	1 line..... 94.99 ea
MF542B	1972	3/8" main fuel line	1 line..... 94.99 ea
MF543B	1972	1/4" return line	1 line..... 94.99 ea
MF544B	1972	5/16" ECS vapor line	2 lines..... 94.99 set
MF545B	1973	5/16" main fuel line	1 line..... 94.99 ea
MF546B	1973	1/4" return line	2 lines..... 94.99 set
MF547B	1974	3/8" main fuel line	1 line..... 94.99 ea
MF548B	1974	1/4" return line	1 line..... 94.99 ea
MF549B	1974	5/16" ECS vapor line	1 line..... 94.99 ea

Your Choice of OEM Material For Originality or Long-Lasting Stainless Steel!



1970-74 E-Body Front to Rear Fuel Lines

Applications are available for various 1970-74 E-Body vehicles including 1970-74 Barracuda, 'Cuda and Challenger.

Note: All fuel lines are shipped double oversize.

Original Material Fuel Lines		#83	
Barracuda, 'Cuda			
MF550A	1970-74	5/16" main fuel line	1 line..... 58.99 ea
MF551A	1970-74	3/8" main fuel line	1 line..... 58.99 ea
MF552A	1970-72	1/4" fuel return line	1 line..... 58.99 ea
MF553A	1970-72	5/16" ECS vapor line	2 lines..... 58.99 set
MF554A	1973-74	1/4" fuel return line	2 lines..... 58.99 set
Challenger			
MF555A	1970-74	5/16" main fuel line	1 line..... 58.99 ea
MF556A	1970-74	3/8" main fuel line	1 line..... 58.99 ea
MF557A	1970-72	1/4" fuel return line	1 line..... 58.99 ea
MF558A	1970-72	5/16" ECS vapor line	2 lines..... 58.99 set
MF559A	1973-74	1/4" fuel return line	2 lines..... 58.99 set

Stainless Steel Fuel Lines		#83	
Barracuda, 'Cuda			
MF550B	1970-74	5/16" main fuel line	1 line..... 94.99 ea
MF551B	1970-74	3/8" main fuel line	1 line..... 94.99 ea
MF552B	1970-72	1/4" fuel return line	1 line..... 94.99 ea
MF553B	1970-72	5/16" ECS vapor line	2 lines..... 94.99 set
MF554B	1973-74	1/4" fuel return line	2 lines..... 94.99 set
Challenger			
MF555B	1970-74	5/16" main fuel line	1 line..... 94.99 ea
MF556B	1970-74	3/8" main fuel line	1 line..... 94.99 ea
MF557B	1970-72	1/4" fuel return line	1 line..... 94.99 ea
MF558B	1970-72	5/16" ECS vapor line	2 lines..... 94.99 set
MF559B	1973-74	1/4" fuel return line	2 lines..... 94.99 set

Fuel System Components



MF305

1963-74 Concoers Fuel Hose Kits

When authenticity is a top priority, you will want to be sure to install correctly marked fuel hose and clamps on your A-Body, B-Body or E-Body vehicle. These concoers quality fuel hose kits feature "KV" and/or "KV -" marked hoses with crimp clamps and spring clamps. Front kits, rear kits or complete car kits are available and come with a diagram outlining the proper placement of hoses. Rear and complete kits also include the correct 3-3/4" long ground strap for the fuel tank sending unit in stainless steel.

Note: Sets are only available with a 3-3/4" ground strap.

Verify: ground strap length before ordering.

Front Sets

MF300	1963-73	340, 383	19.99 set
MF301	1966-67	Hemi	24.99 set
MF302	1967-69	440	39.99 set
MF302	1968-69	Hemi	39.99 set
MF303	1970-74	440, Hemi	34.99 set

Rear Sets

MF304	1963-73	340, 383	24.99 set
MF305	1966-69	440, Hemi	24.99 set
MF306	1970-74	440, Hemi	24.99 set

Complete Car Sets

MF307	1963-73	340, 383	49.99 set
MF308	1966-67	Hemi	44.99 set
MF309	1966-69	440	59.99 set
MF309	1968-69	Hemi	59.99 set
MF310	1970-74	440, Hemi	54.99 set



MF313

Concoers Fuel Hose

When authenticity is a top priority, you'll want to be sure to install a correctly marked fuel hose on your Mopar project. This concoers quality fuel hose consists of "KV" or "KV -" marked hoses in 3-foot lengths. Available in 3/8" or 5/16" diameter for a variety of applications.

Fuel Hose

MF311	5/16"	"KV"	26.99 ea
MF312	3/8"	"KV"	29.99 ea
MF313	3/8"	"KV -"	26.99 ea



Replacement Rubber Fuel Hose

Replace your cracked, broken, crumbling and faded fuel and vapor line hoses with these correct factory fuel and vapor line hoses for originality. Sold by the foot.

MN1704	1/4" ID	1.99 ft
MN1702	5/16" ID	1.99 ft
MN1703	3/8" ID	1.99 ft

Oetiker Hose Clamp

Correct Oetiker hose clamp that connects the rubber fuel lines to steel lines at the fuel tank and at the engine near the fuel pump. Sold individually, these clamps are for 5/16" and 3/8" hose.

MF233	Oetiker hose clamp	1.29 ea
-------	--------------------	---------



MN2297



MN2302

1963-74 Fuel Line Clip Sets

Reproduction fuel line clip sets for 1963-74 A, B & E-Body models. These clips attach the metal fuel lines to the frame. Available for 5/16" or 3/8" fuel lines and available with return line or vapor line clips.

Note: *Includes vapor line clips.

A-Body

MN2297	1963-69	5/16"	12.99 set
MN2298	1963-69	3/8"	12.99 set
MN2299	1970-74	5/16"	29.99 set
MN2300	1970-74	3/8"	32.99 set
MN2301	1963-74	5/16" w/return line	7.99 set
MN2302	1963-74	3/8" w/return line	7.99 set

B-Body

MN2303	1963-65	5/16"	14.99 set
MN2305	1966-70	5/16"	15.99 set
MN2304	1966-70	3/8"	15.99 set
MN2306	1966-70	3/8" w/return line	29.99 set
MN2307	1971-74	5/16" w/return line	34.99 set
MN2308	1971-74	3/8" w/return line	34.99 set

E-Body

MN2309	1970	5/16"	17.99 set
MN2310	1970	3/8"	17.99 set
MN2311	1970	5/16" w/return line	28.99 set
MN2312	1970	3/8" w/return line	28.99 set
MN2313	1971	5/16" w/vapor line	29.99 set
MN2314	1971	3/8" w/vapor line	29.99 set
MN2315	1971	5/16" w/return line	32.99 set
MN2316	1971	3/8" w/return line	36.99 set
MN2317	1972-74	5/16" w/return line	28.99 set
MN2318	1972-74	3/8" w/return line	28.99 set



MF350

1960-68 OE Style Plastic Fuel Filter Sets

These concoers quality 5/16" fuel filters are printed with the correct colors and markings. Officially licensed by Chrysler as a Mopar Authentic Restoration Product and are identical to the originals in every detail. Each filter set includes correctly marked 5/16" plastic fuel filter, two 2" pieces of "KV" hose and four period correct clamps.

Red Imprinted Logo

MF349	1960-63	44.99 set
MF350	1963-67	44.99 set
MF350	1968	Super Stock only 44.99 set



MF320



MF315

1966-72 Date Coded Fuel Filter Sets

These concoers quality 5/16" fuel filters are printed with the correct shade of blue and feature manufacture code, day of year and year codes just like the originals. They are available as a "Factory Original" filter, which is what would have been installed on your car at the factory or as a "Mopar Replacement" which is what would have been sold over the parts counter at the time. Officially licensed by Chrysler as a Mopar Authentic Restoration Product and identical to the originals in every detail. Each filter kit comes with 5/16" date coded steel filter, two 2" pieces of "KV" hose and four period correct clamps.

Factory Original Style

MF373	May	1966	27.99 set
MF374	August	1966	27.99 set
MF375	December	1966	27.99 set
MF314	April	1967	27.99 set
MF315	July	1967	27.99 set
MF316	December	1967	27.99 set
MF317	April	1968	27.99 set
MF318	July	1968	27.99 set
MF319	December	1968	27.99 set
MF320	April	1969	27.99 set
MF321	August	1969	27.99 set
MF322	November	1969	27.99 set
MF323	April	1970	27.99 set
MF324	June	1970	27.99 set
MF325	December	1970	27.99 set
MF326	July	1971	27.99 set
MF327	October	1971	27.99 set
MF328	April	1972	27.99 set
MF329	October	1972	27.99 set

Mopar Replacement Style

MF330	May	1966	27.99 set
MF331	August	1966	27.99 set
MF332	December	1966	27.99 set
MF333	April	1967	27.99 set
MF334	July	1967	27.99 set
MF335	December	1967	27.99 set
MF336	April	1968	27.99 set
MF337	July	1968	27.99 set
MF338	December	1968	27.99 set
MF339	April	1969	27.99 set
MF340	August	1969	27.99 set
MF341	November	1969	27.99 set
MF342	April	1970	27.99 set
MF343	June	1970	27.99 set
MF344	December	1970	27.99 set
MF345	July	1971	27.99 set
MF346	October	1971	27.99 set
MF347	April	1972	27.99 set
MF348	October	1972	27.99 set

Fuel System Components



MF354

1973-74 Date Coded Fuel Filter Sets

These concours quality 5/16" fuel filters are printed in black and feature manufacture code, day and year codes just like the originals. Officially licensed by Chrysler as a Mopar Authentic Restoration Product and identical to the factory installed filters in every detail. Each filter kit comes with 5/16" date coded steel filter, two 2" pieces of "KV" hose and four period correct clamps.

Factory Original Style

MF351	April	1973	29.99	set
MF352	July	1973	29.99	set
MF353	November	1973	29.99	set
MF354	April	1974	29.99	set
MF355	July	1974	29.99	set
MF356	November	1974	29.99	set

Non-Date Coded Steel Fuel Filter Sets

These 5/16" & 3/8" fuel filters are printed with the correct shade of blue and feature the same markings as our date-coded filters but without the date code. They are available as a Factory Original[®] filter which is what



MF357

would have been installed on your car at the factory or as a "Mopar Replacement" which is what would have been sold over the parts counter at the time. Officially licensed by Chrysler as a Mopar Authentic Restoration Product. Each filter set comes with your choice of 5/16" or 3/8" steel filter, two 2" pieces of "KV" hose and four period correct clamps.

Factory Original Style

MF357	5/16"	factory original style	24.99	set
MF358	3/8"	factory original style	31.99	set

Mopar Replacement Style

MF359	5/16"	replacement style	24.99	set
MF360	3/8"	replacement style	31.99	set

1968-74 Fuel Filter/Vapor Separator

Help prevent vapor lock by using the correct fuel filter/vapor separator on your 426 Hemi or 440 equipped vehicle the way the factory intended. This part mounts near the fuel pump and is designed to filter the fuel while simultaneously routing fuel vapor back to the fuel tank. Correct size, shape, mounting bracket, color and lettering make this a must for any serious Mopar project. Applications are available for a variety of 426 Hemi or 440 equipped 1968-74 B-Body and E-Body vehicles.



MF283

MF282	1968-71	426, 440	49.99	ea
MF283	1972	440	64.99	ea
MF284	1973-74	440	74.99	ea



MN2225

1968-71 Throttle Cables

Connect the accelerator linkage to the carburetor with these Mopar Performance throttle cables. These cables include the retaining clip and plug to finish the installation.

MN2225	1968-70	Hemi, 19-3/4" long	39.99	ea
MN2237	1970-71	E-body w/Six Pack	55.99	ea
MN2237	1971	B-body w/Six Pack	55.99	ea



MN2233

1967-76 Throttle Cables

These throttle cables for 1967-76 Mopar models connect the accelerator linkage to the carburetor. Modeled after the originals installed by the factory. Extra long universal throttle cables are available with round or square style end.

Note: For universal extra-long cables check firewall hole size before ordering.

A-Body

MN2227	1968-72	273,318,340	54.99	ea
MN2231	1967-74	383,440	54.99	ea

B-Body

MN2237	1971	w/Six Pack	55.99	ea
MN2228	1971-74	big block	54.99	ea

E-Body

MN2229	1970-74	small block	54.99	ea
MN2228	1970-74	big block	54.99	ea
MN2230	1970-74	Hemi	54.99	ea
MN2237	1971-74	w/Six Pack	55.99	ea

Universal Extra-Long Cables

MN2234	1967-74	27" round style end	49.99	ea
MN2233	1970-76	29" square style end	49.99	ea

New!



MP700200

1968-71 Hemi Throttle Linkage

Replacement progressive throttle linkage for 1968-71 Hemi models with inline 2-4 barrel carburetors. Includes the correct plated ends, ball-end bolt for throttle cable and mounting bolt. Available for standard set-up and Stage Five or Marine Intake Carburetor Linkage.

MP700200	1966-71	original Hemi carb	109.99	ea
MP700201	1966-71	Marine Hemi carb	109.99	ea



Universal Throttle Cable Mounting Bracket

This universal throttle cable mounting bracket attaches to the rear left ear of the carburetor. This bracket was designed to work with MN2236 Torqueflite kickdown cable set or as a universal cable bracket for all 2 and 4 blb applications.

MN2235			39.99	ea
--------	--	--	-------	----



MF224



MF225

1966-74 Throttle Cable Mounting Brackets

Faithfully manufactured throttle cable mounting brackets for a variety of Mopar engine applications. Now you can stop scouring swap meets and salvage yards for these hard-to-find brackets and pick up an authentic replacement from Classic Industries[®]. Each bracket comes complete with hold down and features phosphate finished hex con nuts as original. Applications will fit 4 speed and automatic transmission equipped vehicles as listed.

Small Block

MF224	1968-70	small block, 4 barrel	31.99	ea
MF225	1970	340 six pack	31.99	ea
MN2542	1972-73	340 4 barrel	39.99	ea
MN2542	1974	360 4 barrel	39.99	ea

Big Block

MF221	1966-71	426 Hemi	31.99	ea
MF222	1967-70	big block	31.99	ea
MF223	1969-70	440 six pack	31.99	ea
MN2540	1971	383 4 barrel	39.99	ea
MN2539	1971	440 six pack	31.99	ea
MN2541	1971-72	440 4 barrel	39.99	ea



Throttle Cable Retaining Clip & Nut

Original equipment for all Chrysler engine applications and no longer available from Chrysler. Correct bright zinc plated throttle cable retaining clip with black phosphate conl nuts as original.

MF226	retaining clip and nut	6.99	set
-------	------------------------	------	-----



Idle Solenoid Lower Boot

This lower boot is designed for vehicles with engines that use a fast idle solenoid, including Six Pack and Hemi engines.

MD2398			13.99	ea
--------	--	--	-------	----

Fuel Components



OEM AUTHORIZED

1960-74 Stainless Steel Fuel Tank Sending Units

These premium grade sending units are stainless steel throughout. Each unit is also equipped with a brass float, seal and a premium grade filter.

Applications are available for 1960-74 A-Body, 1962-74 B-Body and 1970-74 E-Body models.

A-Body	1960-62	5/16" outlet	99.99 ea	
MF428	1960-62	3/8" outlet	99.99 ea	
MF255	1963-74	5/16" outlet	99.99 ea	
MF256	1963-74	3/8" outlet, 1/4" return	99.99 ea	
MF259	1967-74	1/2" outlet, 1/4" return	99.99 ea	
B-Body	MF432	1962-65	5/16" outlet	99.99 ea
MF433	1962-65	3/8" outlet	99.99 ea	
MF270	1966-67	5/16" outlet	99.99 ea	
MF271	1966-67	3/8" single outlet	99.99 ea	
MF651	1966-67	1/2" outlet	99.99 ea	
MF272	1968-70	single 5/16" outlet	99.99 ea	
MF273	1968-70	3/8" outlet, 1/4" return	99.99 ea	
MF445	1968-70	1/2" outlet, 1/4" return	99.99 ea	
MF275	1971-72	single 5/16" outlet to April 1972,	99.99 ea	
		to April 1972,	99.99 ea	
MF276	1971-74	3/8" outlet, 1/4" return	99.99 ea	
E-Body	MF279	1970-74	single 5/16" outlet	99.99 ea
MF280	1970-74	3/8" outlet, 1/4" return	99.99 ea	
MF443	1970-74	1/2" outlet, 1/4" return	99.99 ea	



MF255

OEM AUTHORIZED

1962-76 Fuel Tank Sending Units

Fuel tank sending units for a variety 1963-76 A, B and E-Body models.

Each sending unit is manufactured to fit and function exactly as original. Each unit comes complete with sender, float, filter and seal. Applications are available for 1963-76 A-Body models, 1962-73 B-Body models and 1970-74 E-Body models.

A-Body	1963-76	5/16" outlet	69.99 ea	
MF431	1963-76	3/8" outlet, 1/4" return	69.99 ea	
B-Body	MF458	1962-65	5/16" outlet	69.99 ea
MF459	1962-65	3/8" outlet	69.99 ea	
MF434	1966-67	5/16" outlet	69.99 ea	
MF435	1966-67	3/8" outlet	69.99 ea	
MF436	1968-70	5/16" outlet	69.99 ea	
MF437	1968-70	3/8" outlet, 1/4" return	69.99 ea	
MF438	1971-73	3/8" outlet, 1/4" return	69.99 ea	
MF439	1971-72	5/16" outlet (through April 1972)	69.99 ea	
E-Body	MF441	1970-74	5/16" outlet	69.99 ea
MF442	1970-74	3/8" outlet, 1/4" return	69.99 ea	



MF441



MF289

MF287

1960-76 Fuel Tank Sending Unit Parts

Recondition the sending unit on your Mopar vehicle with our selection of replacement parts. These replacement parts will fit a wide range of vehicles across all platforms including A-Body, B-Body and E-Body vehicles.

Filter for Pickup Tube - Molded OE Type	MF285	1960-76	3/8" molded - 2-3/4"	11.99 ea
	MF286	1960-76	3/8" molded - 5" <td>11.99 ea</td>	11.99 ea
Filter for Pickup Tube - Premium Steel Core Type	K404	1960-76	5/16" steel core	11.99 ea
	MF288	1960-76	3/8" steel core	16.99 ea
Float for Sending Unit	479312	1960-76	brass	9.99 ea
Ground Strap for Sending Unit	MF289	1962-76	3-3/4" stainless steel	14.99 ea
	MF290	1962-76	3-3/4" steel	9.99 ea
	MF710	1962-76	8" steel	14.99 ea
Locking Ring for Sending Unit	MF291	1962-76	stainless w/o gasket	14.99 ea
	MF292	1962-76	zinc with gasket	7.99 ea
Locking Ring Installation Tool	MF293	1962-76	steel	16.99 ea
Seal for Sending Unit	MF294	1962-76	rubber	4.99 ea



MF596A

1968-71 Fuel Tank Vent Lines

Correct replacement vent lines or tubes which extend from the fuel tank across the trunk. Choose from OEM material lines which match the factory originals or stainless steel lines which resist rust.

Original Material

B-Body	MF596A	1968-70	exc. Charger, 2 pes.	24.99 pr
	MF597A	1968-70	Charger, on fill neck	14.99 ea
E-Body	MF598A	1970	Challenger, on neck	19.99 ea
	MF599A	1970	Cuda conv., 2 pes.	19.99 pr
	MF600A	1970-71	h/dp, w/o neck ext.	11.99 ea

Stainless Steel

B-Body	MF596B	1968-70	exc. Charger, 2 pes.	34.99 pr
	MF597B	1968-70	Charger on fill neck	19.99 ea
E-Body	MF598B	1970	Challenger, on neck	26.99 ea
	MF599B	1970	Cuda conv., 2 pes.	29.99 pr

Replacement Rubber Vapor Hose

Replace your cracked, broken, crumbling and faded vapor line hoses with these factory correct vapor line hoses for originality. Sold by the foot.

MN1704	1/4" ID	1.99 ft
MN1702	5/16" ID	1.99 ft
MN1703	3/8" ID	1.99 ft



MN1704

B & E-Body Factory

Fuel Vent Line Grommet

Replace your cracked and dried out fuel vent line grommet with this correct OEM grommet.

MN1745	2 required per vehicle	9.99 ea
--------	------------------------	---------

1964-74 Fuel Pump Mounting Bolts

Fuel pump mounting bolts for 1964-74 Mopar models with mechanical fuel pumps. Made from steel and coated in black phosphate.

MMR275	1964-74	7.99 pr
--------	---------	---------

1970-74 E-Body Fuel Vapor Line Bulkhead

Give the trunk compartment of your 1970-74 Barracuda, Cuda or Challenger the finishing touch with a new fuel vapor line bulkhead. Located in the trunk floor of your E-Body, the originals often rust away unnoticed and decay beyond repair. This new vapor line bulkhead comes complete with OEM grommets, correct SEMS screws and die cut closed-cell foam gasket.

MEI323	1970-74	24.99 ea
--------	---------	----------



1960-76 Replacement Fuel Pumps

Choose from a wide range of fuel pumps specifically designed for each year and engine size. Service replacement fuel pumps may vary slightly in appearance from the original however they will fit and function properly. Available for most 1960-76 A-Body, B-Body and E-Body vehicles.



M3497

6 Cylinder

M60577	1960-69	170	fuel pump	19.99 ea
M60577	1970	198	fuel pump	19.99 ea
M4844	1970-71	198	fuel pump	34.99 ea
M60576	1972-76	198	fuel pump	24.99 ea
M60577	1972-74	198	fuel pump	19.99 ea
M60577	1960-70	225	fuel pump	19.99 ea
M4844	1970-71	225	fuel pump	34.99 ea
M60577	1972-74	225	fuel pump	19.99 ea
M60576	1972-76	225	fuel pump	24.99 ea

8 Cylinder

Small Block V8	1968-69	273	fuel pump	21.99 ea
M6866	1960-72	318	fuel pump	21.99 ea
M60514	1973-76	318	fuel pump	19.99 ea
M6866	1968-72	340	fuel pump	21.99 ea
M60514	1973	340	fuel pump	19.99 ea
M60514	1974-76	360	fuel pump	19.99 ea

Big Block V8

M3497	1964	361	fuel pump w/metal line	59.99 ea
M3672	1964-65	361	fuel pump	26.99 ea
M3672	1964-68	383	fuel pump	26.99 ea
M4589	1969-71	383	fuel pump	25.99 ea
M6191	1972	400	fuel pump	35.99 ea
M6935	1973-74	400	fuel pump	25.99 ea
M3672	1967-68	440	fuel pump	26.99 ea
M4434	1969	440	fuel pump	22.99 ea
M4589	1969-70	440	fuel pump	25.99 ea
M4845	1970-71	440	fuel pump	29.99 ea

V8 Chrome Mechanical Fuel Pump

This mechanical fuel pump provides 80 GPH free flow and has a 360 degree rotating lower housing for adjusting alignment. Inlet and outlet fittings are both 1/4" NPT. Gasket is included.



MN2526

MN2525	small block	89.99 ea
MN2526	big block	89.99 ea

Fuel Components

New!



Micro Electric Fuel Pump

This compact electric fuel pump is compatible with all gasoline fuels and additives. The solid state design has a low current draw of around one amp and makes a good stand alone pump or booster pump. Designed for carbureted vehicles with a 12 volt negative ground electrical system, this pump supports 4-7 psi at up to 35 gph. Include fittings, mounting hardware and instructions.

Note: Not for diesel applications.
71211 micro electric fuel pump 39.99 ea

Electric Fuel Pumps

These externally-mounted electric fuel pumps are ideal for most street and strip applications. Proven rotary vane technology provides high flow and stable pressures with minimal vibration and sound. Each pump features 3/8" NPT inlets and outlets along with an externally accessible pressure relief valve. Available in a range of pressures with the choice of chrome or cadmium-plated housings.

Notes: Not for fuel injected engines. Pumps that produce more than 7 psi should be used with a pressure regulator.
Chrome Housing

62531C 100 GPH 7 PSI 79.99 ea
62541C 120 GPH 14 PSI 83.99 ea
62561C 140 GPH 9 PSI 79.99 ea

Cadmium Housing
62531 100 GPH 7 PSI 79.99 ea
62541 120 GPH 14 PSI 79.99 ea
62561 140 GPH 9 PSI 79.99 ea

Holley Electric Fuel Pumps

We offer externally mounted Holley electric fuel pumps. They all feature the proven rotor and vane design and are available in ratings from 97 GPH to 140 GPH. The 97 GPH "red" pump is set at 7 PSI and does not require a regulator. The 110 GPH "blue" pump is set at 14 PSI and includes a regulator. The 140 GPH "black" pump is also set at 14 PSI and can be used for gas or alcohol fuel.

Note: No further discounts apply.
H128011 97 GPH "red" pump 119.99 ea
H128021 110 GPH "blue" pump 139.99 ea
H128151 140 GPH "black" pump 179.99 ea
H12803 regulator 4-1/2 to 9 PSI 29.99 ea



In-Line Street/Strip Electric Fuel Pump

This in-line electric fuel pump is continuous duty rated and is ideal for EFI applications that require additional pumping capabilities for upgraded modifications. Works superbly as either an in-line booster pump or as a stand-alone unit. Use with EFI regulator part# E1728 for adjustability from 35 to 90 PSI. 57 GPH. 3/8" hose barb fittings.

Note: No further discounts apply.
E3594 229.99 ea



Quiet-Flo Electric Fuel Pump

State-of-the-art electric fuel pump offers maximum performance in a compact package for carbureted applications. Anodized aluminum housing and high quality internals make it both strong and durable. Important: For proper installation and voltage requirements, use fuel pump relay E1795.

Note: No further discounts apply.
*Requires an external regulator.
120 GPH Free-Flow, Up to 600 HP 219.99 ea
E1791 6.5 PSI 1/2" inlet/outlet 219.99 ea
160 GPH Free-Flow, Up to 1000 HP 274.99 ea
E1792* 12 PSI 3/8" inlet/outlet 274.99 ea



Quiet-Flo Electric Fuel Pump

This anodized aluminum EFI fuel pump offers maximum performance in a compact package. Its rugged housing and high quality internals make it both strong and durable. The in-line design keeps the pump motor and components cool even under harsh conditions.

Note: No further discounts apply.
10AN inlet/Outlet
Flow rate of up to 80 GPH at 45 PSI for use with high-HP fuel injected applications. This fuel pump supports 835 HP at 12 volts with a current draw of 12 AMPS at 45 PSI. 10AN inlet/outlet 80 GPH at 45 PSI E1790 6-7/8" x 3-1/4" 584.99 ea

12AN inlet/Outlet
Flow rate up to 120 GPH at 45 PSI, and is compatible with all grades of gasoline and methanol type fuel. Each pump is factory tested and includes mounting brackets. This fuel pump supports up to 1040 HP at 12 volts, drawing 18 AMPS at 70 PSI. 12AN inlet/outlet 120 GPH at 45 PSI E1794 7" x 3" 849.99 ea

New!



Edelbrock Pump To Carburetor Fuel Line

These high-quality fuel line kits offer a clean and precise fuel supply line for mechanical fuel pumps with 3/8" NPT outlet to Edelbrock Single-Feed or Dual-Feed fuel inlet kits. These hose kits are pre-assembled hoses with hose ends and are available with stainless steel braided hose or black nylon fabric ProClassic hose.

Note: No further discounts apply.
Stainless Steel Braided Hose
E1823 small block / big block 39.99 ea
Pro Classic Hose
E18123 small block / big block 44.99 ea

PAINLESS



Universal Fuel Pump Relay Set

These relays prevent voltage drops at the pump to maintain constant fuel pressure while preventing amperage overloads from damaging the electrical system. Choose from a regular fuel pump relay set or a weatherproof version designed for harsh conditions. These sets use heavy duty waterproof relays, weatherproof circuit breaker covers and extreme condition weatherproof shrinkable crimp-on terminals.

Note: No further discounts apply.
50102 standard style 44.99 set
30131 weatherproof style 65.99 set

PAINLESS



Perfect Flow Fuel Delivery System

The Perfect Flow Fuel Delivery System is a fuel pump system designed to support up to 1000 horse power in naturally aspirated applications or it can be configured as a main and secondary pump to support up to 500 horse power in situations where a redundant fuel delivery system is needed such as off road use or racing. Set comes with necessary wiring and relays. Due to the many possible plumbing options, no fittings are included with this set.

Note: No further discounts apply.
65100 826.99 set

Fuel Components

New!



Fuel Pump Safety Switch

This fuel pump safety switch shuts off fuel flow whenever oil pressure drops below 15 psi. This adds a safety factor in case of an accident or engine stall. Designed for 12 volt electrical systems and can be tied into the oil pressure sending unit with an 1/8" NPT tee. 77872 21.99 ea



Fuel Pump Safety Switch

This safety feature is a must have for any electric fuel-pump-fed Muscle Car. This fuel pump safety switch monitors the tach signal to limit when an electric fuel pump can operate. When the key is first turned on, the fuel pump is allowed to run for three seconds, priming the system. Then, the fuel pump only operates if the engine is running. No plumbing into the oil lines or extra priming button is required. RE12003 64.99 ea



Fuel Pump Vacuum/Pressure Tester

Tests for fuel line pressure and vacuum leaks. Check for leaky valves, timing, fuel pump, vacuum, pressure and gas line leakage. Easy to read gauge with 3 foot hose and vacuum hose adapter fitting. Gauge measures vacuum from 0 to 28" HG in 1" increments, (0 to 700mm HG in 50mm increments). Measures pressure from 0 to 15 psi in 1/2 psi increments (0-1Kg/cm2 in .1 Kg/cm2 increments). Y20300 27.99 ea

New!



Inline Fuel Pressure Gauge

Set and monitor fuel pressure with these easy-to-use gauges! Each gauge measures 1-1/2" in diameter with a 0-15 psi range in 1/2 lb increments. Gauges are available in standard form or liquid filled for better vibration resistance and readability. 71560 39.99 ea
71564 liquid filled gauge 41.99 ea

PAINLESS



Universal Fuel Pump Relay Set

Choose from a standard fuel pump relay or a weatherproof fuel pump relay which is perfect for the harsh weather conditions. Weatherproof relay set provides complete protection from the elements and ensures reliable, dependable performance utilizing a heavy duty waterproof relay, weatherproof circuit breaker covers and extreme condition weatherproof shrinkable crimp-on terminals.

Note: No further discounts apply.
50102 standard 44.99 set
30131 weatherproof 65.99 set

Edelbrock



Universal Fuel Pump Relay

This universal fuel pump relay will ensure proper wiring which to reduce the risk of damaging the fuel pump, and offers consistent fuel pressure. This relay is used with fuel pump part# E1791 or E1792.

Note: No further discounts apply.
E1795 59.99 ea

New!



Super Cool Can

This insulated fuel cooler tank chills the fuel to create a dense fuel charge, allowing more horsepower and reducing detonation. The insulation allows it to hold ice twice as long as traditional cork-insulated cans. Each 7-3/4" x 7-3/4" x 8" insulated polyethylene cooler has an internal aluminum heat sink with a 1/2 quart fuel capacity. Includes NHRA-approved aluminum mounting bracket and t-bolt stainless steel straps. Note: Not recommended for use with high-pressure fuel injection systems. 265125 fuel cool can 139.99 ea

Edelbrock



Fuel Pressure Regulator

This fuel pressure regulator is machined from aircraft quality aluminum with fluorosilicone diaphragm material for high temperature protection and extended life. This fuel pressure regulator has a single 3/8" NPT inlet and dual 3/8" NPT outlets for carbureted applications and is adjustable from 5 PSI to 10 PSI, providing extremely consistent pressure regulation. Compatible with all grades of gasoline and methanol, and has a 1/8" NPT gauge port. Includes mounting brackets and hardware.

Note: No further discounts apply.
E1727 160 GPH 144.99 ea

SUMMITRIDE

New!



Billet Fuel Pressure Regulator

On high horsepower engines it is sometimes necessary to regulate the fuel pressure especially when using high volume high pressure fuel pumps. Made from billet aluminum construction this regulator is suitable for engines up to 450 hp and will allow adjustments from 4.5 to 9 psi. One 3/8" NPT inlet and two 3/8" NPT outlets. 62511 67.99 ea

Edelbrock



Fuel Pressure Regulators

For those who want the best! These fuel pressure regulators are machined from aircraft quality aluminum and have fluorosilicone diaphragm material for high temperature protection and extended life. The E1728 features dual -6AN inlet ports, a single -6AN outlet and a -6AN external bypass. The E1729 has a longer body and dual -10AN inlet ports, a single -10AN outlet and a -6AN external bypass. They are compatible with all grades of gasoline and methanol fuels. Both units are adjustable from 35 PSI to 90 PSI and have 1/8" NPT gauge ports.

Note: No further discounts apply.
E1728 180 GPH 199.99 ea
E1729 180 GPH 209.99 ea

SUMMITRIDE

New!



Royal Purple Max Clean Fuel System Cleaner

Max-Clean cleans and cleans deposit build up in the fuel system and combustion chamber. Royal Purple's Max-Clean can restore internal engine surfaces, recovering lost fuel economy and performance. RP11722 20 can 15.99 ea
RP11723 case of 6 - 20 oz cans 86.99 ea



Replacement Carburetors



MN2908



MN2904



MN2900



MN2964

1962-76 Remanufactured Carburetors

Highest quality remanufactured carburetors for 1962-76 Mopar models with 6 or 8 cylinder engines. Carburetors are available for Slant Six, LA V8, B-series V8 and RB-series V8 and available for a variety of applications. Choose from Holley, Carter, Stromberg, or Rochester carbs. Each carburetor is thoroughly remanufactured

with the highest quality components and tested to ensure optimum performance and fuel economy.

***Features solenoid lever opposite the throttle arm. **Does not feature solenoid opposite the throttle arm.*

1 bbl Carburetors for Slant Six Engines

Holley Carburetors			
MN2930	1962-63	Dart & Lancer	179.99 ea
MN3133	1964-66	except 66 with AC	195.99 ea
MN3133	1964-67	full size	195.99 ea
MN3133	1966-67	Dart (except 66 w/o AC) (Ca.)	195.99 ea
MN2936	1966-68	full size (except 66 Dart AT w/o AC)	169.99 ea
MN2940	1969		169.99 ea
MN2944	1970	except California	149.99 ea
MN3142	1970	California only	195.99 ea
MN3142	1971-72		195.99 ea
MN2945	1973		169.99 ea
MN2946	1974		159.99 ea
MN2947	1975	with AT, Dart w/ECS & idle enrichment	159.99 ea
MN2948	1975	with AT, w/o ECS	159.99 ea
MN2949	1975	with ECS & w/o idle enrichment	159.99 ea
MN2950	1975	with MT, w/o ECS	159.99 ea
MN2949	1976	with MT, except California	159.99 ea
MN2951	1976	with AT, except California	159.99 ea

Carter Carburetors			
MN2931	1962-63	except full size	149.99 ea
MN2932	1964-65		119.99 ea
MN2934	1964-66	Dart (except 65-66 w/AC)	149.99 ea
MN3137	1966-68	except 68 AT	185.99 ea
MN2938	1968	with AT	149.99 ea
MN2939	1969		179.99 ea
MN2943	1970	except California	164.99 ea
MN2941	1970	California only	149.99 ea
MN2941	1971		149.99 ea

2 bbl Carburetors for LA & R/B Engines

Holley Carburetors			
MN2908	1971		199.99 ea
MN2908	1972	except California	199.99 ea
MN2974	1972	California only, except 400ci	219.99 ea
MN2962	1973	with AT, 360 only	149.99 ea
MN2909	1973	with AT, 400 only	149.99 ea
MN2910	1974		199.99 ea
MN2911	1975	with AT, with solenoid	169.99 ea
MN2914	1975-76	with AT, w/o solenoid	159.99 ea

Carter Carburetors			
MN3152	1964-65		185.99 ea
MN3154	1966-67	except California	185.99 ea
MN3154	1966-67	with AT, California only	185.99 ea
MN2957	1966-67	with MT, California only	139.99 ea
MN3154	1968-69	with AT	185.99 ea
MN2957	1968-69	with MT	139.99 ea
MN3154	1970	with AT, except California	185.99 ea
MN3158	1970	with AT, California only	185.99 ea
MN2957	1970	with MT, except California	139.99 ea
MN2959	1970	with MT, California only	149.99 ea
MN3158	1971	with AT	185.99 ea
MN2959	1971	with MT	149.99 ea
MN3158	1972	with AT	185.99 ea
MN2959	1972	with MT, except California	149.99 ea
MN2976	1972	with AT, except California	119.99 ea
MN2975	1973	with AT, California only	209.99 ea
MN2963	1973	MT	149.99 ea
MN2966	1974	with AT, except California	139.99 ea
MN2965	1974	with AT, California only	179.99 ea

2 bbl Carburetors for LA & R/B Engines - Continued

Carter Carburetors Cont'd			
MN2968	1974	with MT, except California	139.99 ea
MN2967	1974	with MT, California only	199.99 ea
MN2905	1975	with AT, w/o venturi vacuum	149.99 ea
MN2971	1975	with MT	159.99 ea
MN2904**	1976	with AT, w/o solenoid	159.99 ea
MN2906*	1976	with AT, California only	149.99 ea
MN2904**	1976	with AT, w/air pump, except California	159.99 ea
MN2907	1976	with AT, w/o air pump, except California	149.99 ea
MN2968	1976	MT	139.99 ea

Stromberg Carburetors

MN2953	1964-65	Stromberg	189.99 ea
MN2955	1966-67	Stromberg	149.99 ea

Rochester Carburetors

MN2960	1971	Rochester	189.99 ea
--------	------	-----------	-----------

2 bbl Carburetors for B Engines

Carter Carburetors			
MN2960	1967-67	except 1964 Polara	159.99 ea
MN2901	1968-69	except California	159.99 ea
MN2903	1970	California only	129.99 ea
MN2902	1970	California only	129.99 ea
MN2902	1971		129.99 ea

Stromberg Carburetors

MN2916	1965-67		179.99 ea
--------	---------	--	-----------

4 bbl Carburetors for LA Engines

Carter Carburetors			
MN2970	1971-72		244.99 ea
MN2964	1973		249.99 ea

4 bbl Carburetors for R/B Engines

Holley Carburetors			
MN2924	1967-69	440 only, Inc. Challenger	269.99 ea
MN3127	1970	383 only, Inc. Challenger	295.99 ea
MN2973	1971	383 only, Inc. Challenger	209.99 ea
MN2925	1972	440 with AT, Inc. Challenger	209.99 ea

Carter Carburetors

MN3115	1966		379.99 ea
MN2926	1968-69		269.99 ea
MN2928	1970	except California	269.99 ea
MN2918	1971	440 with AT	269.99 ea
MN2920	1973-74	440 with AT	239.99 ea
MN2929	1973-74	440 H.P with AT	239.99 ea
MN2920	1974	440 H.P with AT, California only	239.99 ea
MN2913	1975	with AT, except California	239.99 ea
MN2912	1975-76	with AT, California only	359.99 ea
MN2913	1976	with AT, except California with H.P.	239.99 ea

4 bbl Carburetors for B Engines

Carter Carburetors			
MN3115	1964-65	AFB (except 1966-67 MT, Ca.)	379.99 ea
MN3115	1966-67	AFB (except 1966-67 MT, Ca.)	379.99 ea
MN3117	1968-69	AFB	309.99 ea
MN2918	1971	with AT	269.99 ea
MN2919	1972		239.99 ea
MN2964	1973		249.99 ea
MN2920	1974		239.99 ea
MN2929	1974	with AT, Hi-Performance engines	239.99 ea
MN2969	1974		289.99 ea
MN2913	1975	with AT	239.99 ea
MN2912	1975	with AT, except California wagon	359.99 ea
MN2913	1975	w/AT, California wagon only, w/solenoid	239.99 ea
MN2922	1975	w/AT, California wagon only, w/o solenoid	309.99 ea
MN2913	1976	with AT, except Lean Burn	239.99 ea
MN2923	1976	with AT, Lean Burn only	239.99 ea

Performance Fuel System

New!

Holley



H4235



H4236

Holley Cross Ram Carburetors

Authentic replacement Holley four barrel carburetors for 1964-65 and 1968 426 race HEMI engines with cross ram intake systems. Each special 4160 carburetor has the correct stamped list number stamped along with original right/left side linkages and diaphragm finish. Both right and left side carburetors are 770 cfm with vacuum secondaries. The right side carburetor replaces O.E. number 2946263 and the left side replaces 2946262.

Note: No further discounts apply.



H4235 770 cfm right side carburetor ... 636.99 ea
H4236 770 cfm left side carburetor ... 636.99 ea

New!



Six-Pack Choke Assembly

Replacement choke assembly for six-pack equipped engines. Features the yellow chromate and zinc finished parts as original.

MP700205 340 six-pack 74.99 ea
MP700205 440 six-pack 74.99 ea

New!



Six-Pack Upper Fuel Line Set

Replacement upper fuel lines for six-pack equipped engines. Replace the old fuel lines with brand new ones. Set includes the proper bent, flared, steel lines with fittings to the carburetors and the proper connector fittings. Sold as a set.

MP700206 340 six-pack 39.99 set
MP700206 440 six-pack 39.99 set

New!



Six-Pack Carburetor Linkage

Replacement carburetor linkage for six-pack equipped engines. Linkage connects the front and rear carburetors with the center carburetor. Linkage includes gold-anodized front and rear carburetor rods with clips, adjusting pivots and pin. Sold assembled.
MP700207 340 six-pack 74.99 set
MP700207 440 six-pack 74.99 set



CB712651



CB712850

Street Series Carburetors

These Quick Fuel Super Street carburetors offer race performance in a lightweight, street-friendly package. These carburetors are manufactured from aluminum and designed for maximum tunability. Available with vacuum secondaries or a mechanical secondary design.

Note: This product is not CARB exempt. Products that are not CARB exempt are legal in most states, but may not be used in California or states with similar emissions laws except on pre-1976 vehicles.

Mechanical Secondary Carburetors

CB712650 650 CFM 574.99 ea
CB712651 650 CFM annular booster . 619.99 ea
CB712652 650 CFM blow through... 779.99 ea
CB712653 650 CFM E85 compatible. 619.99 ea
CB712750 750 CFM 579.99 ea
CB712751 750 CFM annular booster. 634.99 ea
CB712752 750 CFM E85 compatible. 664.99 ea
CB712830 830 CFM 584.99 ea
CB712850 850 CFM 604.99 ea

Vacuum Secondary Carburetors

CB712680 680 CFM 554.99 ea
CB712735 735 CFM 559.99 ea
CB712780 780 CFM 569.99 ea
CB712880 880 CFM 574.99 ea



CB711650

Hot Rod Series Carburetors

The Hot Rod Series of carburetors is designed for street applications. Hand assembled and engine tested in the USA! Available in both vacuum and mechanical secondaries.

Note: This product is not CARB exempt. Products that are not CARB exempt are legal in most states, but may not be used in California or states with similar emissions laws except on pre-1976 vehicles.

Mechanical Secondary Carburetors

CB711600 600 CFM 419.99 ea
CB711650 650 CFM 449.99 ea
CB711750 750 CFM 531.99 ea
CB711850 850 CFM 551.99 ea

Vacuum Secondary Carburetors

CB711580 580 CFM 419.99 ea
CB711680 680 CFM 439.99 ea
CB711780 780 CFM 449.99 ea



CB710600

- Changeable Idle Air and High-Speed Bleeds
- 3-Stage Emulsion Circuits
- QFT™ QuickSet™ Adjustment
- Notched Secondary Float for Use With Jet Extensions
- Secondary Metering Plate w/Changeable Jets
- Fully Adjustable Electric Choke
- Polished Finish for Superior Good Looks

Slayer Series Carburetor

The 600 and 750 cfm Slayer Series carburetors are designed with the same engineering innovations and featured on all QFT™ products. These affordable, vacuum secondary street carburetors feature all aluminum construction and hand-built quality. They are designed with a secondary metering plate with changeable jets, eliminating the need for a costly secondary metering block.

Note: This product is not CARB exempt. Products that are not CARB exempt are legal in most states, but may not be used in California except on pre-1976 vehicles or states with similar emissions laws.

CB710600 600 CFM electric choke . 329.99 ea
CB710750 750 CFM electric choke . 329.99 ea

FUEL & EXHAUST

Performance Fuel System

New!

DEMON
with 2550 RPM



D1901



Street Demon Carburetors

The Street Demon is available in 625 and 750 CFM and supports stock and mildly modified V8's with smooth, crisp throttle response. A dual bolt pattern works with most four barrel spread bore and square flange intake manifolds. Includes integrated 700R4/200R4 transmission kickdown location and electric choke.

Made in USA.

Notes: No further discounts apply

UNMATCHED
E-Street

625 CFM	
D1900	with ball burnished finish..... 314.99 ea
D1901	with polymer main body..... 314.99 ea
D1902	with hand polished finish..... 466.99 ea
750 CFM	
D1903	with ball burnished finish..... 346.99 ea
D1904	with polymer main body..... 346.99 ea
D1905	with hand polished finish..... 474.99 ea

New!

DEMON
with 2550 RPM



Demon Carburetor Throttle Stud

When installing a Demon carburetor, this stud may be necessary for proper throttle, cruise control and other linkage related functions. The stud simply fits through one of the linkage mounting points and is held by the supplied lock washer and nut.

Notes: No further discounts apply.

UNMATCHED
E-Street

D124007 29.99 ea
---------	----------------

New!



H4674



H209

Holley Throttle Solenoid

Universal throttle solenoid bracket for many Holley aftermarket carburetors. Use with solenoid H4674 and nut H2657 both sold separately.

H4674	throttle solenoid..... 84.99 ea
H2657	solenoid nut..... 7.99 ea
H209	solenoid bracket..... 9.99 ea

MSD
with 2550 RPM



2900



2910

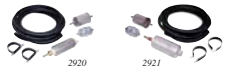

MSD Atomic EFI Set

The MSD Atomic EFI set fits all engines making up to 525 horsepower at the crankshaft. Throttle bodies feature 80 lb. injectors, a self-calibrating throttle position sensor, and an internal fuel rail for no-leak, no-hassle fuel delivery. The master set is complete and ready to use out of the box. Also available are the throttle body set which includes everything except for the fuel system components. Or purchase the fuel components separately.

Notes: No further discounts apply.

UNMATCHED
E-Street

Atomic EFI Master Set	
2900 2429.99 set
Throttle Body Set	
2910 2169.99 set
Fuel System Components	
2920	for up to 525hp..... 404.99 set
2921	for up to 650hp..... 611.99 set

New!

MOBROSD



EFI Fuel Return Adapter

When converting a carbureted vehicle to an EFI system that requires a fuel return system, there's no longer any need to buy an expensive fuel tank. This adapter creates a return system simply by cutting a 2-3/4" section out of any standard 2" fuel filter tube. Made from aluminum with a 3/8" fitting that points 90 degrees downward to direct fuel back to the bottom of the tank. Each set includes the adapter with two buna rubber sleeves and four stainless steel clamps for a leak proof seal.

265385 49.99 set
--------	-----------------

New!

Edelbrock



E3601

- Novice-Friendly Tuning Software with Full Parameter Controls.
- Self-Mapping Fuel Curve Corrects and Diagnostics in Your Time!
- Progressive Throttle Linkage Improves Driveability and Mileage.

E-Street Universal EFI System

Upgrade any carbureted V8 to electronic fuel injection with this E-Street throttle body EFI system! Easily installs on any intake manifold with a square flange 4150 style mount and accepts virtually any cleaner. Includes high flow four-barrel throttle body, simple-to-install wiring harness, wide band O2 sensor, computer with a pre-loaded tune, and a handheld touchscreen for easy step-by-step wireless programming. Choose from the base version for use with an existing high pressure fuel system or a complete set with your choice of fuel system.

Notes: No further discounts apply.

UNMATCHED
E-Street

Base EFI System	
E3600	w/o fuel system..... 2239.99 set
Complete EFI System	
E3602	w/return fuel system..... 2719.99 set
E3606	w/fuel sump fuel system..... 2549.99 set

New!

Edelbrock



E3604

Edelbrock High Pressure Fuel System Sets

Upgrading to fuel injection requires a high pressure fuel system. Edelbrock offers a number of options for converting to high pressure for fuel injection installation.

Notes: No further discounts apply.

UNMATCHED
E-Street

Return-Style Fuel System

Includes high pressure fuel pump, filter, hoses, adjustable pressure regulator with return port, fittings, mounting brackets, and hardware. Supports up to 600 HP.

E3604	return style fuel system..... 571.99 set
-------	--

Fuel Sump Module System

Includes 13" x 7-3/4" x 5" sump, high pressure fuel pump and regulator pre-installed, wiring harness, fuel filters, hose, fittings, brackets and mounting hardware. Supports up to 600 HP.

E3605	58 psi fuel sump system..... 591.99 set
E3607	49 psi fuel sump system..... 591.99 set

Carburetor Parts

New!

Edelbrock



closed view



E1489



E1841



Edelbrock Carburetor Calibration Sets

These sets include a selection of metering rods, jets, and step-up springs that allow fine tuning and calibration of Edelbrock Performer and Thunder Series carburetors for mildly to extremely built motors, especially motors with performance camshafts that cause low intake manifold vacuum. Made in USA.

Note: Not legal for pollution controlled vehicles.

No further discounts apply.

Performer Series Sets

E1479	1405 models	69.99 set
E1480	1407, 1410, 1412 & 1413 models	64.99 set
E1486	1403, 1404, 1801 models	61.99 set
E1486	1802, 1803 & 1804 models	61.99 set
E1487	1406 models	44.99 set
E1488	1409 models	61.99 set
E1489	1411 models	51.99 set

Thunder AVS Series Sets

E1840	1805 & 1806 models	59.99 set
E1841	1812 & 1813 models	71.99 set
E1842	1826 models	59.99 set

New!

DEKON
RACE SYSTEMS



Street Demon Calibration Set

This calibration kit allows fine tuning of Street Demon carburetors. Although the carburetors are already fine tuned other adjustments and modifications may be necessary for optimal performance in built engines with large cams. This kit includes an assortment of primary jets, metering rods and step-up springs along with secondary jets all in a convenient plastic storage case.

Note: No further discounts apply.

D1921 79.99 set

New!

HALLOW
RACE SYSTEMS



42567

42563

Billet Choke Covers

These chrome-plated choke covers enhance the appearance of dressed engines by covering the plastic choke on Edelbrock, Demon, and Holley carburetors. Each billet aluminum cover comes with a snap-in levered insert. Available as an individual cover or as a kit with polished stainless steel conduit.

Note: No further discounts apply.

42567 choke cover 23.99 ea

42563 choke cover kit 44.99 ea

New!

DEKON
RACE SYSTEMS



Demon Universal Installation Set

This set contains installation hardware for most Demon 4 barrel carburetors, including mounting studs, washers, nuts, air cleaner studs, vacuum caps, throttle cable tyals with bushing adapters for throttle levers and three types of base gaskets for square and spread bore carburetors, including a gasket for the Street Demon.

Note: No further discounts apply.

D160049 Demon installation set 19.99 set

New!

MOROSO



Carburetor Wedge Plate

During hard acceleration the float bowls in a carburetor become uneven, causing moderate fuel starvation. This aluminum spacer tilts the carburetor forward 5 degrees to help keep it level. This spacer measures .830" at its thickest point and has a dual bolt pattern for standard Holley, Carter AFB, and Edelbrock carburetors.

Note: Not legal for use on pollution controlled vehicles.

265030 39.99 ea

New!

Edelbrock



E1843

Edelbrock Throttle Lever Adapter

This throttle lever adapter fits 1966 and later vehicles to correctly adapt Performer and Thunder Series carburetors for use with the original cables. Works with vehicles equipped with cruise control and includes mounting hardware. Choose from gold iridite plating or black finish.

Note: Not for use on pollution controlled vehicles.

E1481 gold throttle lever adapter 11.99 ea

E1843 black throttle lever adapter 12.99 ea

New!

DRIVEN
DEFENDER
DRIVE BY

Driven Carb Defender

Driven Carb Defender fuel additive has been formulated to protect against significant harmful ethanol deposits and corrosion in fuel and the induction system.

Special inhibitors resist expensive damage and reduced performance from moisture accumulation from modern ethanol-blended gasoline.

This additive controls combustion chamber residue, cleaning and protecting fuel system and intake tract surfaces to keep carburetors functioning properly. Fuel Defender is ideal for everyday drivers or classics that spend time in storage between cruises and special events.

One bottle treats up to 25 gallons of ethanol-blended fuel.

JG1340 4.5 oz bottle 9.99 ea

JG1341 case of 6 - 4.5 oz. bottles 59.99 cs



FUEL & EXHAUST

Carburetor Parts

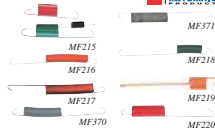

1966-73 Throttle Return Springs

Not only can incorrect throttle return springs take away from the appearance of your Mopar, they can also be downright dangerous if they do not have the tension and strength specifications for your application. Don't risk using incorrect universal springs that can cause unsafe or engine-damaging conditions. These throttle return springs feature the correct number of windings for proper tension and are powder coated in correct colors for a long-lasting authentic appearance.

Small Block		
MF220 1966-73	33 coil, red	7.99 ea
MF219 1970	340 six pack, 16 coil, orange	9.99 ea
Big Block		
MF215 1966-71	426 Hemi w/dual 4 bbl.	24.99 set
MF216 1967	4 bbl, 55 coil, orange	7.99 ea
MF217 1968	4 bbl, 49 coil, green w/orange	7.99 ea
MF370 1969	4 bbl, 45 coil, gray	7.99 ea
MF371 1970-71	B-Body, 4 bbl, 45 coil, gray	7.99 ea
MF218 1970-72	4 bbl, 34 coil, green	7.99 ea
MF219 1969-71	440 six pack, 16 coil, orange	9.99 ea



1964-74 Throttle Return Spring Brackets

Faithfully manufactured throttle return spring brackets for a variety of engine applications. Now you can stop scouring swap meets and salvage yards for these hard-to-find brackets and pick up your brackets from Classic Industries®.

Small Block		
MF210 1967-73	318, 360 2 bbl.	9.99 ea
MF211 1968-70	340 4 bbl.	14.99 ea
MF212 1970	340 six pack.	14.99 ea
MF213 1971-73	340, 360, thru 473.	14.99 ea
MF214 1974-76	318, 360 w/2 bbl.	9.99 ea
Big Block		
MF203 1964-66		14.99 ea
MF204 1966-71	426 w/dual 4 bbl.	24.99 pr
MF205 1967-68	w/AC	14.99 ea
MF206 1967-69	w/o AC	11.99 ea
MF207 1969-74	bolts to AC comp back	14.99 ea
MF208 1969-71	440 six pack.	14.99 ea
MF209 1970-72	w/o AC	19.99 ea



1970-71 Idle Solenoid

Correct reproduction idle solenoid for 1970-71 Mopar models with 340 and 440 engines.

MD2397 1970-71	129.99 ea
----------------	-----------



1970 340 Six Pack Idle Solenoid Bracket

Faithfully manufactured with the stiffening boss and real cadmium plating, this bracket comes complete with zinc dichromate coin keps nuts with the same dimensions as originals. Bolts on top of front carburetor base using rear two mounting bolts. A must for any AAR or T/A project!

MF201 solenoid bracket	27.99 ea
------------------------	----------



Idle Screw Caps

These replacement idle screw caps snap on the idle mixture screws of Carter AVS and Holley carburetors. Applications are available for big block and small block engines. Small block caps are black in color while big block caps are red. Sold as a pair.

Small Block - Black	
MF298 275, 318, 340, 360	9.99 pr
Big Block - Red	
MF299 383, 400, 440 and hemi.	11.99 pr



1966-74 Air Cleaner Stud and Wing Nut

Replace the missing or damaged air cleaner mounting hardware on your Mopar with one of our correctly manufactured air cleaner studs and nuts. Each stud features original phosphate finish with correctly formed thread lengths on each end for an authentic factory fresh appearance. The wing nut will fit all 1/4-20UNC air cleaner studs. Each wing nut is stamped from heavy gauge steel to duplicate original dimensions and zinc plated for proper appearance and a long lasting shine. Note: 340 and 440 six pack require two studs.

Air Cleaner to Carburetor Studs	
MF227 1966-71 426 Hemi w/Carter AFB	3.99 ea
MF228 1968-71 with Carter AVS	3.99 ea
MF227 1969 440-6 w/lift-off hood	3.99 ea
MF229 1970-71 340 and 440 six pack	8.99 ea
Wing Nut	
MF230 1962-74 for 1/4-20UNC studs	2.99 ea



Holley Six Pack Vacuum Diaphragm Screws

Correct 8-32 x 5/8" phillips head screws in the zinc dichromate finish as original. If your Holley Six Pack vacuum diaphragm pot screws are damaged or missing, replace them with these diaphragm screws. Sold individually, six screws are required per carburetor. MF232 vacuum diaphragm pot screw... 1.49 ea



Holley Six Pack Float Bowl Screw Set

Correct length screws (4 long & 8 short) in the zinc dichromate finish as original. Includes 12 gaskets. New Holley carburetors have hex head screws that are incorrect for the period, so replace them with correct style parts and maintain an OE appearance. MF231 24 pc screw and gasket set... 17.99 set

Carter AVS 4-Barrel Choke Assembly

4-barrel Carter AVS choke assembly. Features correct markings stamped on the choke housing and yellow chromate and zinc finished parts as original. Includes carburetor attaching clip and correct mounting screw.

MF200 1968-69 383/440	49.99 ea
MF200 1968-70 340	49.99 ea
MF653 1970 383/440	54.99 ea
MF653 1971 440	54.99 ea



1966-69 Hemi Thermal Choke Tubes

Reproduction thermal choke tubes for 1966-69 Street Hemi models. Each set includes upper and lower tube and a white heat-resistant cover for the upper tube. The lower tube has the correct fitting to screw into the right hand exhaust manifold. Available in OE material or stainless steel.

MD6669 1966-69 OE material	34.99 set
MD6669S 1966-69 stainless steel	35.99 set

Edelbrock and Holley Carburetors

Proven performance for
any carbureted vehicle!

Edelbrock



E1405



E1406

Performer Series Carburetors

Performer Series carburetors complete the Edelbrock Power Package System for a smooth running and great performing "no guesswork" parts combination. By design, Performer Series square-bore carbs are refined to provide the widest possible torque range when matched with Edelbrock Performer, Performer RPM, RPM Air-Gap or Torker II manifold and camshaft combinations. However, these carburetors are not limited to these applications, they also match well with most stock and other manifolds of similar design. Edelbrock carbs put the fun back into your driving because of a unique ability to "hold a tune". This means that compared to other carburetors, performance remains consistent and calibration is held perfectly. Performer Series square-bore carbs are all aluminum, ball burnished and lightweight. There are no power valves to blow out or plastic parts to break. The two piece construction resists warping and the metering rods can be changed in seconds without removing the carburetor. These Edelbrock carbs bolt-on and run right out of the box! Simply dependable, proven performance for almost any carbureted vehicle. All Edelbrock carbs come with an installation kit and owners manual.

600 CFM Carburetors

Recommended for most Performer applications and small cubic-inch Torker II applications. Includes both timed and full vacuum ports for ignition advance.

Note: No further discounts apply.

E1405	600 cfm	manual choke	304.99 ea
E1406	600 cfm	electric choke	334.99 ea

750 CFM Carburetors

Recommended for most Performer RPM or Torker II applications and big block Performer applications. Provides excellent fuel economy when used on big block Performer applications. Includes both timed and full vacuum ports for ignition advance. Note: No further discounts apply.

E1407	750 cfm	manual choke	344.99 ea
E1411	750 cfm	electric choke	374.99 ea

EPS 800 CFM Carburetors

The new EPS 800 carb is designed and calibrated for street high-performance engines. Dyno tests show that the EPS 800 carb outperformed a Holley #3310 carb out of the box on a small block equipped with Performer RPM components. Features include a high-capacity accelerator pump and an improved secondary cluster design.

Note: No further discounts apply.

E1412	800 cfm	manual choke	429.99 ea
E1413	800 cfm	electric choke	429.99 ea

Holley Vacuum Secondary Carburetors

These classic Holley 4160 Series carburetors are available in several sizes and with manual or electric choke. These carburetors feature vacuum secondaries and power valve blow-out protection. All are bright chrome finish.

Note: No further discounts apply.

H1850	600 CFM	manual choke	309.99 ea
H80457	600 CFM	electric choke	321.99 ea
H3310	750 CFM	manual choke	339.99 ea
H80508	750 CFM	electric choke	335.99 ea

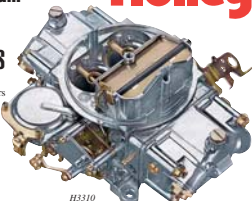

H3310



Holley Mechanical Secondary Carburetors

These classic Holley 4150 Series double pump carburetors are available in several sizes. These carburetors feature mechanical secondaries, center hung float bowls and power valve blow-out protection. All have manual choke.

Note: No further discounts apply.

H4776	600 CFM	manual choke	464.99 ea
H4779	750 CFM	manual choke	494.99 ea
H4780	800 CFM	manual choke	524.99 ea
H4781	850 CFM	manual choke	524.99 ea

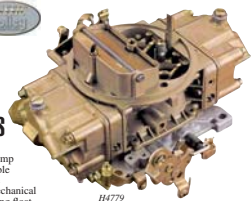

H4779



Holley Street Avenger Carburetors

The Holley 4150 Series Street Avenger™ Series carburetors are the first true performance carbs specifically designed, dyno tested and calibrated for performance on the street. They feature the No Trouble™ adjustable vacuum secondary, four vacuum ports, electric choke, external float adjustment and Holley's new Gen IV Power Valve. If you're looking for better throttle response, quicker acceleration, enhanced fuel economy and superior drivability, Holley Street Avenger™ carbs are your answer.

Note: No further discounts apply.

H80670	670 CFM	four barrel	431.99 ea
H80770	770 CFM	toll free	431.99 ea



H80670



FUEL & EXHAUST

Holley Carburetor Components

Holley Main Jets

These Holley jets are sold in sets of two and are available in jet sizes ranging from #40 to #110. The jets are will give the broadest range of most adjustment and performance for most performance carburetor applications.

Notes: No further discounts apply.

Part Number	Jet Size	Price
H12240	#40	7.99 pr
H12241	#41	7.99 pr
H12242	#42	7.99 pr
H12243	#43	7.99 pr
H12244	#44	7.99 pr
H12245	#45	7.99 pr
H12246	#46	7.99 pr
H12247	#47	7.99 pr
H12248	#48	7.99 pr
H12249	#49	7.99 pr
H12250	#50	7.99 pr
H12251	#51	7.99 pr
H12252	#52	7.99 pr
H12253	#53	7.99 pr
H12254	#54	7.99 pr
H12255	#55	7.99 pr
H12256	#56	7.99 pr
H12257	#57	7.99 pr
H12258	#58	7.99 pr
H12259	#59	7.99 pr
H12260	#60	7.99 pr
H12261	#61	7.99 pr
H12262	#62	7.99 pr
H12263	#63	7.99 pr
H12264	#64	7.99 pr
H12265	#65	7.99 pr
H12266	#66	7.99 pr
H12267	#67	7.99 pr
H12268	#68	7.99 pr
H12269	#69	7.99 pr
H12270	#70	7.99 pr
H12271	#71	7.99 pr
H12272	#72	7.99 pr
H12273	#73	7.99 pr
H12274	#74	7.99 pr
H12275	#75	7.99 pr
H12276	#76	7.99 pr
H12277	#77	7.99 pr
H12278	#78	7.99 pr
H12279	#79	7.99 pr
H12280	#80	7.99 pr
H12281	#81	7.99 pr
H12282	#82	7.99 pr
H12283	#83	7.99 pr
H12284	#84	7.99 pr
H12285	#85	7.99 pr
H12286	#86	7.99 pr
H12287	#87	7.99 pr
H12288	#88	7.99 pr
H12289	#89	7.99 pr
H12290	#90	7.99 pr
H12291	#91	7.99 pr
H12292	#92	7.99 pr
H12293	#93	7.99 pr
H12294	#94	7.99 pr
H12295	#95	7.99 pr
H12296	#96	7.99 pr
H12297	#97	7.99 pr
H12298	#98	7.99 pr
H12299	#99	7.99 pr
H12300	#100	7.99 pr
H12301	#101	7.99 pr
H12302	#102	7.99 pr
H12303	#103	7.99 pr
H12304	#104	7.99 pr
H12305	#105	7.99 pr
H12306	#106	7.99 pr
H12307	#107	7.99 pr
H12308	#108	7.99 pr
H12309	#109	7.99 pr
H12310	#110	7.99 pr



H12240



Holley



H12135



H12140



Accelerator Pump Squirters

We offer several sizes and styles of accelerator pump squirters. Choose from straight type or tube style for 4150, 4160 and 4500 series carburetors. All include 2 gaskets.

Note: No further discounts apply.

Straight Type

H121125	.025	straight...	12.99 pr
H121128	.028	straight...	12.99 pr
H121131	.031	straight...	12.99 pr
H121135	.035	straight...	12.99 pr
H121137	.037	straight...	12.99 pr
H121140	.040	straight...	12.99 pr
H121142	.042	straight...	12.99 pr
H121145	.045	straight...	12.99 pr

Tube Type

H12125	.025	tube...	21.99 pr
H12128	.028	tube...	21.99 pr
H12131	.031	tube...	21.99 pr
H12135	.035	tube...	21.99 pr
H12137	.037	tube...	21.99 pr
H12140	.040	tube...	21.99 pr
H12142	.042	tube...	21.99 pr
H12145	.045	tube...	21.99 pr

Holley



H12565



Holley Power Valves

The power valve is a key component of the power enrichment system of Holley performance carburetors. These power valves incorporate "power valve blow-off protection".

Note: No further discounts apply.

Standard Flow

H12525	2.5" Hg.	9.99 ea
H12535	3.5" Hg.	9.99 ea
H12545	4.5" Hg.	9.99 ea
H12555	5.5" Hg.	9.99 ea
H12565	6.5" Hg.	9.99 ea
H12585	8.5" Hg.	9.99 ea
H125105	10.5" Hg.	9.99 ea

High Flow

H125125	2.5" Hg.	15.99 ea
H125135	3.5" Hg.	15.99 ea
H125145	4.5" Hg.	15.99 ea
H125155	5.5" Hg.	15.99 ea
H125165	6.5" Hg.	15.99 ea
H125185	8.5" Hg.	15.99 ea
H1251005	10.5" Hg.	15.99 ea

New!



Holley

1969-71 Holley Six Pack Carburetors

These reproduction carburetors from Holley are nearly exact duplicates of the ones that came on 1969-71 six pack engines, from the vacuum hook-ups and fuel inlets to the diaphragm finish.

Note: Only center carburetors have a choke. No further discounts apply.

Big Block

H4144	1969-70	350 CFM Center Carburetor A/T	629.99 ea
H4670	1971	350 CFM Center Carburetor A/T	539.99 ea
H4365	1969-70	500 CFM Outboard Carburetor A/T M/T	449.99 ea
H4672	1971	500 CFM Outboard Carburetor A/T M/T	421.99 ea

Small Block

H4792	1970-71	350 CFM Center Carburetor A/T	529.99 ea
H4790	1970-71	500 CFM Outboard Carburetor A/T	414.99 ea

New!



Six Pack Installation Kit

This installation kit allows you to hook up a small block or big block six-barrel induction system. Includes throttle cables, fuel lines, coil brackets, linkage kits, chokes, nuts, springs and washers.

MN45058 small block installation kit 321.99 kit

Holley



Holley Jet Assortment Set

The Holley jet assortment set is the professional way to tack-tune your Holley carburetor for top performance. The set consists of two 2 each of 36 different jet sizes ranging from #64 to #99. The jets come in a plastic case that keeps them separated and make them easily accessible. Jet sizes selected will give the broadest range of adjustment and performance for most performance carburetor applications.

Note: No further discounts apply.

H36181 \$59.99 set

Holley



Carburetor Needle and Seat

We offer several needle and seat assemblies for Holley carburetors. The seat size determines how much fuel can flow at a certain pressure. Larger sizes allow more fuel to flow. Tune your Holley carburetor to flow the right amount of fuel at the proper pressure with a new Viton-tipped needle and seat.

Note: No further discounts apply.

H5056	.97 adjustable	14.99 ea
H5054	.110 adjustable	15.99 ea
H5618	.120 adjustable	25.99 ea
H6513	.97 off road	25.99 ea

Hedman Hedders

1966-76 Hedman Hedders

Hedman Hedders™ for 1966-76 Mopar models. These hedders are designed to replace the heavy and restrictive factory manifolds with light weight, free-flowing tubular steel manifolds.

Each set of hedders comes complete and is ready to bolt on. Includes collector and header to head gaskets, collectors and bolts. Will fit models with AC, power steering and either manual or automatic floor or column shift mechanisms. Get more performance from your Mopar without breaking the bank and do it with a name you can trust in the header business: "Hedman".

Important: Be sure to read the important notes listed on the bottom of this page pertaining to each header system for correct application.

Note: Shipped overseas. No further discounts apply.

**HEDMAN
HEDDERS**



78030 Painted header

78036 HTC coated header



A-Body

Part#	Year	Models	Header Style	Engine Size	Notes	Tube Dia.	Collector Dia.	Price
78050	1967-69	Barracuda	Painted Hedder	273-360	1, 13, 129	1-5/8"	3"	214.99 set
78050	1967-76	Dart, Demon	Painted Hedder	273-360	1, 13, 129	1-5/8"	3"	214.99 set
78050	1967-76	Valiant, Scamp	Painted Hedder	273-360	1, 13, 129	1-5/8"	3"	214.99 set
78056	1967-69	Barracuda	Hi-Tech Coating (HTC)	273-360	1, 13, 129	1-5/8"	3"	479.99 set
78056	1967-76	Dart, Demon	Hi-Tech Coating (HTC)	273-360	1, 13, 129	1-5/8"	3"	479.99 set
78056	1967-76	Valiant, Scamp	Hi-Tech Coating (HTC)	273-360	1, 13, 129	1-5/8"	3"	479.99 set
78500	1967-69	Barracuda	Painted Hedder (tight tube)	273-360	1, 13, 15, 151	1-5/8"	2-1/2"	289.99 set
78500	1967-76	Dart, Demon	Painted Hedder (tight tube)	273-360	1, 13, 15, 151	1-5/8"	2-1/2"	289.99 set
78500	1967-76	Valiant, Scamp	Painted Hedder (tight tube)	273-360	1, 13, 15, 151	1-5/8"	2-1/2"	289.99 set
78506	1967-69	Barracuda	HTC (tight tube)	273-360	1, 13, 15, 151	1-5/8"	2-1/2"	585.99 set
78506	1967-76	Dart, Demon	HTC (tight tube)	273-360	1, 13, 15, 151	1-5/8"	2-1/2"	585.99 set
78506	1967-76	Valiant, Scamp	HTC (tight tube)	273-360	1, 13, 15, 151	1-5/8"	2-1/2"	585.99 set

B-Body

78050	1967-74	Plymouth B-Body	Painted Hedder	273-360	1, 13, 129	1-5/8"	3"	214.99 set
78050	1966-74	Charger	Painted Hedder	273-360	1, 13, 129	1-5/8"	3"	214.99 set
78056	1967-74	Plymouth B-Body	Hi-Tech Coating (HTC)	273-360	1, 13, 129	1-5/8"	3"	479.99 set
78056	1966-74	Charger	Hi-Tech Coating (HTC)	273-360	1, 13, 129	1-5/8"	3"	479.99 set
78500	1967-74	Plymouth B-Body	Painted Hedder (tight tube)	273-360	1, 13, 15, 151	1-5/8"	3"	289.99 set
78500	1966-74	Charger	Painted Hedder (tight tube)	273-360	1, 13, 15, 151	1-5/8"	3"	289.99 set
78506	1967-74	Plymouth B-Body	HTC (tight tube)	273-360	1, 13, 15, 151	1-5/8"	3"	585.99 set
78506	1967-74	Charger	HTC (tight tube)	273-360	1, 13, 15, 151	1-5/8"	3"	585.99 set
78030	1967-74	Plymouth B-Body	Painted Hedder	361-440	1, 129	1-3/4"	3"	209.99 set
78030	1966-74	Charger	Painted Hedder	361-440	1, 129	1-3/4"	3"	209.99 set
78036	1967-74	Plymouth B-Body	Hi-Tech Coating (HTC)	361-440	1, 129	1-3/4"	3"	479.99 set
78036	1966-74	Charger	Hi-Tech Coating (HTC)	361-440	1, 129	1-3/4"	3"	479.99 set
78038	1967-74	Plymouth B-Body	Elite Hedder	361-440	1, 129	1-3/4"	3"	504.99 set
78038	1966-74	Charger	Elite Hedder	361-440	1, 129	1-3/4"	3"	504.99 set
78070	1967-74	Plymouth B-Body	Painted Hedder	361-440	1, 15, 151	1-3/4"	2-1/2"	229.99 set
78070	1966-74	Charger	Painted Hedder	361-440	1, 15, 151	1-3/4"	2-1/2"	229.99 set
78076	1967-74	Plymouth B-Body	Hi-Tech Coating (HTC)	361-440	1, 15, 151	1-3/4"	2-1/2"	489.99 set
78076	1966-74	Charger	Hi-Tech Coating (HTC)	361-440	1, 15, 151	1-3/4"	2-1/2"	489.99 set

E-Body

78050	1970-74	all models	Painted Hedder	273-360	1, 13, 129	1-5/8"	3"	214.99 set
78056	1970-74	all models	Hi-Tech Coating (HTC)	273-360	1, 13, 129	1-5/8"	3"	479.99 set
78500	1970-74	all models	Painted Hedder (tight tube)	273-360	1, 13, 15, 151	1-5/8"	2-1/2"	289.99 set
78506	1970-74	all models	HTC (tight tube)	273-360	1, 13, 15, 151	1-5/8"	2-1/2"	585.99 set
78030	1970-74	all models	Painted Hedder	361-440	1, 129	1-3/4"	3"	209.99 set
78036	1970-74	all models	Hi-Tech Coating (HTC)	361-440	1, 129	1-3/4"	3"	479.99 set
78038	1970-74	all models	Elite Hedder	361-440	1, 129	1-3/4"	3"	504.99 set
78070	1970-74	all models	Painted Hedder	361-440	1, 15, 151	1-3/4"	2-1/2"	229.99 set
78076	1970-74	all models	Hi-Tech Coating (HTC)	361-440	1, 15, 151	1-3/4"	2-1/2"	489.99 set

Hedman Hedder Notes

(1) Without smog injection or injection heads.

(2) LA-type engine only. (will fit with in-line port patterns only).

(3) Shortie hedder (Max. ground clearance).

(29) Modification to shift linkage may be needed.

(15) Must use mini-starter.

Exhaust Hardware



1966-71 Hemi Exhaust Manifolds

Replacement exhaust manifolds for 1966-71 Hemi models. Each manifold features correct casting numbers on the manifold, choke control system and the correct textured finish. Available with or without the heat riser.

MD4529	1966-70	w/ heat riser	1509.99	pr
MD4529	1966-70	w/o heat riser	919.99	pr
MD4530	1971	w/ heat riser	1449.99	pr
MD4529	1971	w/o heat riser	919.99	pr



1966-71 Hemi Heat Riser Set

Replacement heat riser set for 1966-71 Hemi models. This set is designed to fit and install onto the RH manifold and includes all necessary parts and hardware. Made in USA.

MD4532	1966-71	heat riser set	424.99	set
--------	---------	----------------	--------	-----

1966-71 Hemi Heat Tubes

These Hemi heat tubes run from the RH side of the exhaust manifold to the intake manifold. Mandrel bent steel as original.

Note: Does not include gaskets or shield.

MN2334	1966-71	RH (2 flanges)	64.99	ea
MN2335	1966-71	LH (1 flange)	64.99	ea
MN2336	1966-71	heat tube clamp	29.99	ea
MN2333	1966-71	heat tube/clamp set	154.99	pr

1960-76 Exhaust Manifold Gaskets

Performance gaskets handle up to 350°. Ultra-Seal uses a high density material that handles up to 650°. Copper-Seal uses "dead soft" solid copper for extreme heat applications such as turbo-charged vehicles.

Small Block

Performance				
MN2322	1967-74	1.00" x 1.64"	19.99	pr
MN2326	1975-76	1.30" x 1.80"	19.99	pr
MN2323	1967-74	1.00" x 1.64"	31.99	pr
MN2325	1975-76	1.25" x 1.68"	24.99	pr
MN2327	1975-76	1.30" x 1.80"	24.99	pr
Copper-Seal				
MN2324	1967-74	1.00" x 1.64"	44.99	pr

Big Block (exc. Hemi)

Performance				
MN2328	1960-76	1.78 x 1.48"	16.99	pr

Ultra-Seal

MN2329	1960-76	1.78" x 1.48"	24.99	pr
MN2331	1960-76	1.71" x 2.08"	31.99	pr

Copper-Seal

MN2330	1960-76	1.78" x 1.48"	44.99	pr
--------	---------	---------------	-------	----

426 Hemi

Ultra-Seal				
MN2332	1966-71	1.85" x 1.89"	24.99	pr



Exhaust Manifold Flange Gaskets

These flange gaskets connect the exhaust manifold to the head pipe. Made from thick 3/8" steel material that is much less likely to warp than common 1/4" exhaust flanges. 2 required. MN2337 2-1/4" flange 9.99 ea MN2338 2-1/2" flange 9.99 ea

New!



Small Head Header Bolt Sets

These 12 piece small head bolt sets are designed to replace regular hex head bolts for easier access and fewer skinned knuckles. Available in both black oxide and zinc finishes.

Black Oxide Hex Head				
66341	3/8"-16 x 3/4"	4.99	set	
66342	3/8"-16 x 1"	11.99	set	
Zinc Hex Head				
17970	3/8"-16 x 3/4"	5.99	set	
17973	3/8"-16 x 1"	7.99	set	

New!

340-360 Header Bolt Sets

These ARP premium exhaust header hardware kits feature compact 12-point nuts to let you easily slip a socket close to the pipe. Studs are manufactured with a unique nut-starter nose that helps prevent cross-threading. Available in either black oxide chrome-moly or Stainless 300 which resists corrosion and extreme heat. Both are nominally rated at 170,000 psi tensile strength; substantially stronger than Grade 8.

Black Oxide
AR1425 hex head 17.99 set
AR1426 12-point 18.99 set
Stainless
AR1427 hex head 24.99 set
AR1428 12-point 24.99 set

New!

Oxygen Sensor Plug

This plug seals the oxygen sensor bung on headers and exhaust manifolds. Made from trivalent chromium plated steel with a M-18 thread size to fit most stainless headers. 222734 M-18 thread 9.99 ea

Oxygen Sensor Fitting

Weld-in oxygen sensor fitting for all fuel injection systems.

Note: No further discounts apply.
60406 14.99 ea



Exhaust Manifold Fastener Sets

If you're after originality for your underhood project, don't settle for anything less than these complete sets of OE-type bolts to mount your exhaust manifolds.

Max Wedge				
MN1505	1962-64	34.99	set
440 HP				
MN1500	1967	44.99	set
383/440 HP				
MN1502	1967-69	49.99	set
MN1503	1968-71	54.99	set
426 Hemi				
MN1504	1966-71	64.99	set
340 HP				
MN1613	1968-70	44.99	set
383/440 HP				
MN1501	1968-74	34.99	set
340/360 HP				
MN1499	1971-74	46.99	set
Studs Only - 2 Required				
MM8273	1966-74	all	9.99	set



1966-71 Flange Gaskets

This flange gasket fits between the exhaust pipe and the cross pipe on 1966-71 Hemi models. Made of asbestos. MN2339 1966-71 18.99 set

New!



1972 OE Style Air Pump Belts

Are your belts showing signs of deterioration? If so, it's time to replace them with our original style reproduction belts. Officially licensed by Mopar! With AC And With PS
B4767 Belv, Chrg 34.99 ea
B4767 Crnt, Rd Rr 34.99 ea
B4767 Chrysler Pass. Car. 34.99 ea
B4767 Dodge/Plymouth 34.99 ea
With AC and Without PS
B4766 Belv, Chrg 34.99 ea
B4766 Crnt, Rd Rr 34.99 ea
B4766 Dodge/Plymouth 34.99 ea
With **41, 50, 60 Air Aid**
B4765 Belv, Chrg 34.99 ea
B4765 Crnt, Rd Rr 34.99 ea
B4765 Dodge/Plymouth 34.99 ea

Exhaust Heat Protection



Quick-Wrap Exhaust Jackets

The new quick-wrap, high-velocity Exhaust Jackets™ are an innovative way to insulate and block radiant heat. The jackets cover the header tubes vertically allowing for a consistent fit. The fit allows the exhaust system to expand as it comes up to operating temperatures without restrictions and provides air space for added insulation. This product uses Thermo-Conduction Technology (TCT), developed by Thermo-Tec® and can be applied with the headers in the vehicle.

TT1015	4-6 cylinder.....	66.99 ea
TT1016	8 cylinder.....	84.99 ea

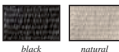

black natural

Coated Fiberglass Header Wrap

Insultherm Header Wrap is an extremely high temperature-resistant wrap used to insulate hot gases in automotive exhausts. Manufactured from texturized fiberglass yarns that are woven into a strong, flexible wrap with vermiculite coating. Resists gasoline and other engine chemicals and withstands temperatures up to 1200° F (maximum continuous temperature of 1000° F). Available in black or natural in 50' or 25' rolls.

1" Header Wrap		
HW719301	black 1" x 50'.....	19.99 ea
HW719302	natural 1" x 50'.....	18.99 ea
HW719303	black 1" x 25'.....	9.99 ea
HW719304	natural 1" x 25'.....	8.99 ea
2" Header Wrap		
HW719311	black 2" x 50'.....	26.99 ea
HW719312	natural 2" x 50'.....	25.99 ea
HW719313	black 2" x 25'.....	16.99 ea
HW719314	natural 2" x 25'.....	15.99 ea

Generation II Copper Header Wrap

Generation II Copper Header Wrap improves heat resistance up to 30% more than current technology, by utilizing a new proprietary coating developed by Thermo-Tec: improved Thermal-Conduction-Technology (T-C-T).

Generation II Copper Exhaust Wrap creates more horsepower and reduces under-hood temperatures, increases exhaust scavenging, withstands continuous heat up to 2000°F, contains no asbestos.

TT11031	1" x 50'.....	31.99 ea
TT11032	2" x 50'.....	54.99 ea



Exhaust Insulating Wrap

The original Exhaust Insulating Wrap™ was developed over 12 years ago by Thermo-Tec®. Wrapping headers maintains hotter exhaust gases that exit the system faster through decreased density. Increased exhaust scavenging is produced, along with lower intake temperatures. Exhaust Insulating Wrap™ withstands continuous heat up to 2000°F and contains no asbestos. Thermo-Tec® exhaust wrap will not over-insulate a system when properly installed due to a proprietary coating developed by Thermo-Tec® Thermal Conduction Technology (TCT) that conducts heat across the wrap's surface. This coating controls heat buildup and dissipation. The 1/16" thick wrap is available in 1 inch or 2 inch widths in 15' or 50' rolls. Choose from off-white or graphite black.

Off-White Exhaust Wrap		
TT1009	1" x 15' short roll.....	9.99 ea
TT1011	2" x 15' short roll.....	15.99 ea
TT1010	1" x 50' long roll.....	29.99 ea
TT1012	2" x 50' long roll.....	44.99 ea
Graphite Black Exhaust Wrap		
TT1053	1" x 15' short roll.....	11.99 ea
TT1054	2" x 15' short roll.....	19.99 ea
TT1013	1" x 50' long roll, black.....	31.99 ea
TT1014	2" x 50' long roll, black.....	49.99 ea



Header Manifold Blanket

The Header Manifold Blanket™ provides excellent heat-retention for exhaust headers and manifolds. This flexible heat shield simply clips into place on the upper portion of the header. The fabric side of the material should be facing the heat source and the aluminumized side facing away—offering protection from abrasion and harmful liquid spills. The Header Manifold Blanket™ is available in two sizes: (2) 20" by 24" blankets for V6 & V8 applications and (1) 36" by 40" blanket for straight 6 & 4 cylinder engines.

TT1017	V6-V8 applications.....	85.99 pr
TT1018	slant 6 applications.....	89.99 ea

Heat Protection & Tools



Socket Assist

Essential tool for bolts with tight clearance like spark plugs and header bolts! 12-point for maximum finger traction. Set of three including 1/4" x 1/4", 1/4" x 3/8", 3/8" x 3/8" (12 pt x socket drive size). These belong in every tool box.

67575 3 piece set..... 9.99 set



TT14260

Cool-It Plug Wire Sleeves

This unique spark plug and ignition wire protector is available in four colors; red, blue, black and silver. These dual-purpose sleeves enhance performance, reduce misfires, extend plug wire life and will not react with petroleum products. The double-wall construction keeps the wire and boot cooler in a high-temperature engine. Its universal size fits most boots, is easy to install and - most importantly - is nonflammable.

4-Pack	
TT14261 black.....	39.99 set
TT14261 red.....	39.99 set
TT14263 blue.....	31.99 set
TT14260 silver.....	39.99 set



SS729101

High Temperature Stainless Steel Cable Tie

High temperature stainless steel cable ties are great for harsh environments. Perfect for installing heavy duty and high temp sleeving. Available in 7-1/2" or 14-1/2" lengths.

Individual	
SS719101 7-1/2".....	.99 ea
SS719102 14-1/2".....	1.19 ea
5 Pack	
SS729101 7-1/2".....	4.99 kit
SS729102 14-1/2".....	5.99 kit
10 Pack	
SS729103 7-1/2".....	8.99 kit
SS729104 14-1/2".....	10.99 kit



Exhaust and Tailpipe Cutter

Cuts pipes 3/4" to 3" (19mm to 76mm) in diameter. 15 blades effectively cut pipe so only 1/4" turn is needed for complete cut. Works great in hard to reach areas.

X2031 43.99 ea



Tailpipe Expander

Used to remove clamp grooves and round out crushed or bent exhaust pipes to ensure a tight fit, eliminating exhaust leaks. The hex end allows the use of a combination wrench to remove clamp grooves or small imperfections, or an impact wrench to expand pipes.

X3442 1-13/16" to 2-1/2" i.d. 34.99 ea



Hi-Heat Coating

To finish off a clean and well-protected Exhaust Insulating Wrap application it is recommended to use the Hi-Heat Coating. The coating will protect the wrap from abrasion and harmful liquid spills. Extra resins and binders toughen the surface, extend the life of wrap by protecting it from friction and seal the pores to minimize the penetration of harmful liquids. The coating also works excellent as a paint directly on metal surfaces.

TT12001 11 oz. black.....	9.99 ea
TT12002 11 oz. aluminum.....	9.99 ea
TT12003 11 oz. copper.....	12.99 ea



Exhaust Repair Kit

Complete kit for repairing cracks and splits in mufflers tailpipes and exhaust pipes. Withstands temperatures over 1000° F. The kit contains ready to use foil packed bandage and support wire. Repair small cracks in the muffler or tailpipe without the expensive cost of a complete replacement.

S80334 2.99 ea

DER® Hi-Temp Exhaust Coat



A fast drying coating designed to withstand temperatures up to 1200 degrees F on a continuous basis. Forms a porcelain-like bond after curing. Resists blistering, peeling, discoloration, or loss of adhesion. Excellent for headers, manifolds, mufflers, pipes and more.

Note: Ships ground only. No air shipment.

16 oz. Can	
K89555 silver.....	14.99 ea
K89556 black.....	14.99 ea
K0090 cast iron gray.....	14.99 ea
Case of Six 16 oz. cans	
K89557 silver.....	79.99 cs
K89558 black.....	79.99 cs
K89559 cast iron gray.....	79.99 cs

Muffler and Tailpipe Sealer

Seals holes and leaks in mufflers, tailpipes and around joints. Makes new installation more secure. Resists temperatures up to 2000° F. Great for use on mufflers, tailpipes, joints and catalytic converters.

S80335 3 oz. tube 2.99 ea



Muffler and Tailpipe Putty

Permanently repairs holes and leaks in exhaust systems. Seals out fumes at temperatures up to 2000° F. Safe for catalytic converters. For use with mufflers, tailpipes and joints. This small kit could help to eliminate problems with the exhaust without expensive replacement.

S80333 4 oz. pouches..... 2.99 ea



Muffler and Tailpipe Bandage

Epoxy impregnated fiberglass bandage chemically welds mufflers and tailpipes. Permanently repairs holes and leaks in exhaust systems saving costly part replacement. Seals out poisonous fumes to temperatures of 800° F.

S80331 84 sq. in..... 2.99 ea



THERMO-TEC® Insulation

*Insulate Your Interior Compartment
From Excessive Heat & Noise!*



TT1005

- Floorboard
- Firewall
- Doors
- Headliner
- Under-Hood
- Transmission Hump

Cool It Mat

Use the Cool-It Mat™ to battle excessive heat and noise that penetrate the driver compartment through the firewall and floorboards. It is also perfect in doors, under-hoods and above transmission housings. The Cool-It Mat™ is composed of resin-bonded silica blanketing insulation sandwiched between a mylar facing on one side and a foil facing on the other. The highly-reflective mylar reflects heat away from surfaces, while the foil side is orientated away from the heat source to conduct any penetrating heat across its surface thus providing the ultimate in heat protection. The silica blanketing is a dual-density composite and is the main sound insulator. It is easy to trim and can be applied with the push-in fasteners provided or any weather strip adhesive. Two sizes to fit your individual needs.

TT1005 24" x 48" insulating mat 31.99 ea
TT1006 48" x 48" insulating mat 64.99 ea



Super Sonic Acoustical Mat



This high quality mat offers superior sound dampening control to reduce road noise, rattles, engine noise and any other noises that are bothersome. The high density polyethylene film with an aluminum foil composite is abrasion and tear resistant. The gray film provides structural integrity & strength, allowing the material to bend, move, & return to shape even under tension forces. The product is 70 mil in thickness, contains a high temperature adhesive backing and is easy to trim & fit. The rubberized compound is applied with the high temperature adhesive to absorb all those out of control noises.

TT14700 12" x 12" 2 pieces 19.99 pr
TT14710 36" x 24" cut to fit 29.99 ea
TT14720 36" x 60" cut to fit 61.99 ea



Keep Cool! Reflect Radiant Heat Away From Your Passenger Compartment!

The Muffler/Catalytic Converter Heat Shield™ is made up of woven silica with a flexible mylar finish. The highly-reflective heat shield can be installed between the catalytic converter, muffler, or any other component to reflect radiant heat away from the undercarriage of the car. The kit includes one 24" x 40" mylar heat shield and all necessary fasteners.

TT1007 muffler heat shield 61.99 ea



Suppressor Acoustical & Heat Control Mat



The Suppressor is ideal when both sound and radiant heat control is needed. In addition to the polyethylene film, the foil surface provides direct protection from radiant heat. Great for areas like firewalls, floorboards or doors. The Suppressor is also 70 mil in thickness, contains a high temperature adhesive backing and is easy to trim & fit.

TT14600 12" x 12" 2 pieces 19.99 pr
TT14610 36" x 24" cut to fit 29.99 ea
TT14620 36" x 60" cut to fit 54.99 ea

THERMO-TEC® Insulation



TT1020

Thermo-Sleeve

Thermo-Sleeve is the combination of a high temperature fabric laminated to a highly reflective Mylar foil. It provides protection from radiant heat for hoses and wires. Thermo-Sleeve's ultra lightweight construction provides more insulation than traditional bulky rubber-coated fiberglass. The aluminized sleeve reflects more than 90% of radiant heat, plus it is fireproof and oil resistant!

3' Foot Lengths

TT1020	1/4" to 1/2" inside dia.	14.99 roll
TT1021	5/8" to 1" inside dia.	16.99 roll
TT1022	1-1/8" to 1-1/2" inside dia.	21.99 roll
TT1023	1-5/8" to 2" inside dia.	26.99 roll
TT1024	2-1/8" to 2-1/2" inside dia.	31.99 roll



Shield Plastic or Rubber Hoses & Wiring From Radiant Heat!

Thermo-Shield™ protects hoses and wires from radiant heat. Unprotected, rubber hoses and plastic or rubber insulated wiring can dry out, melt or crack over time. Thermo-Shield™ is used in applications where it is difficult or not practical to disconnect one end of the hose or wire. The adhesive-backed composite construction tape can easily be wrapped around the hose or wire to make a clean, professional appearance. Reflects radiant heat up to 2000° F. Provides a barrier against the extreme conditions that under-hood components are exposed to. Wrap your fuel lines and say good-bye to vapor lock.



TT1019	1-1/2" x 15' feet	15.99 ea
TT1051	2" x 50' feet	49.99 ea

Protect Your Vehicle From Corrosive Battery Acid!

Excessive heat in the engine compartment will cause most standard batteries to spew or seep corrosive battery acid. This in turn will not only corrode your vehicle's battery tray, under-hood and radiator support area, but will also reduce the longevity of your battery. Prolong battery life with the world's only acid-neutralizing heat barrier mat. It reflects over 90% of radiant heat, traps and neutralizes battery acid, protects against corrosion, is recyclable, protects the environment and is inexpensive and easy to install. The Battery Heat Barrier™ set is completely safe to handle before and during installation. It is so effective, it is used by all branches of the United States military. Set consists of one 8" x 40" acid absorbing/neutralizing felt & one adhesive backed 8" x 40" aluminum thermal barrier to wrap around the battery, plus an 8" x 12" acid absorbing/neutralizing pad to put beneath the battery. Install one on your vehicle NOW, before it's too late.



TT1001	battery heat shield set	29.99 set
--------	-------------------------	-----------



Thermo-Guard FR

Thermo-Guard FR offers the best heat and sound insulation! This lightweight, durable shield does everything: reduces sound, absorbs vibration, protects from radiant heat and provides an extra layer of insulated padding. The product features 100% polyester fiber felt that provides sound and comfort control and a high-tech foil heat barrier that blocks more than 90% of radiant heat. Thermo-Guard FR is very easy to apply and it can be trimmed to fit anywhere. Designed to be applied with Thermo-Tec's Heavy-Duty Spray Adhesive.

TT1055	24" x 48" one-side foil	19.99 ea
TT1056	48" x 72" one-side foil	49.99 ea
TT1057	48" x 72" two-side foil	61.99 ea



Starter Heat Shield™ Set

In today's high-heat environment, starters take in a lot of damaging heat that destroys the windings of the starter and solenoid. To combat this problem, we offer a non-conductive strap-on heat shield with a highly-reflective mylar surface. The Starter Heat Shield™ will reflect over 90% of radiant heat, adding life to the starter and assuring reliable starts. The Starter Heat Shield™ is a universal set that fits all starters. TT1002 Starter Heat Shield™ set with straps..... 25.99 set



Adhesive Heat Barrier™

Use your imagination and you will find many uses for this heat-reflecting mat. Adhesive backed, this Heat Barrier™ protects parts and components from radiant heat. It can be used in applications to protect painted surfaces, plastic parts or any component from the damaging effects of radiant heat. Aluminized Heat Barrier™ is made up of woven silica with a flexible aluminized finish. The highly reflective surface of the material is capable of withstanding radiant temperatures in excess of 2000°F. The adhesive backed composite construction material can easily be applied to any surface or wrapped around a hose or wire to make a clean professional appearance.



TT1003	12" x 12" adhesive backed Heat Barrier™ mat	11.99 ea
TT1004	12" x 24" adhesive backed Heat Barrier™ mat	21.99 ea
TT1049	24" x 36" adhesive backed Heat Barrier™ mat	54.99 ea
TT1050	24" x 48" adhesive backed Heat Barrier™ mat	69.99 ea

Exhaust System Components

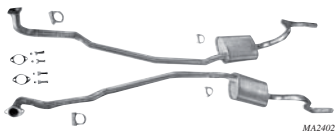

1962-76 Exhaust Systems

MA2402

High-quality replacement exhaust systems for various 1962-76 A.B. and E-Body models. Get years of dependable service and long-lasting good looks with an exhaust system that includes all mounting hardware except hangers. Applications are available for a wide variety of vehicles.

Important: Except where otherwise noted, exhaust tips are not included with any exhaust system.

Note: Shipped truck freight. No further discounts apply.



A-Body

MA2396	1963-74	slant 6, 111" WB	419.99	set
MA2398	1963-74	slant 6, 111" WB high performance	419.99	set
MA2407	1965-66	Hi-po System w/resonator/tip assembly	949.99	set
MA2399	1967	383 Barracuda w/turndown tail pipes	734.99	set
MA2400	1967	383 Dart w/turndown tail pipes	734.99	set
MA2408	1967	Hi-po System w/resonator/tip assembly	949.99	set
MA2409	1967-74	318 Factory style single system	529.99	set
MA2410	1967-74	318 Factory style w/larger pipe/muffler	649.99	set
MA2395	1967-76	slant 6, 108" WB	419.99	set
MA2397	1967-76	slant 6, 108" WB high performance	419.99	set
MA2401	1968-69	383 Barracuda w/exhaust tips	734.99	set
MA2402	1968-69	340 Barracuda for exhaust tips	719.99	set
MA2403	1968-69	383 Dart w/exhaust tips	734.99	set
MA2404	1968-69	340 Dart w/exhaust tips	719.99	set
MA2405	1971-74	All 340/360 Systems w/exhaust tips	719.99	set
MA2406	1971-74	All 340/360 w/turndown tail pipes	719.99	set

B-Body

MB2536	1962	Max Wedge 413-426 System	1429.99	set
MB2552	1962	361/383/426 Wedge w/turndown t/pipe	789.99	set
MB2537	1963	Max Wedge 413/426 System	1429.99	set
MB2553	1963-65	361/383/426 Wedge system	789.99	set
MB2554	1966-67	361/383 w/turndown tail pipes	789.99	set
MB2543	1966-67	426 Hemi w/turndown tail pipes	959.99	set
MB2545	1967	440 system w/turndown pipes	844.99	set
MB2550	1967	426 Hemi GTX for exhaust tips	959.99	set
MB2551	1967	440 GTX system for exhaust tips	929.99	set
MB2546	1968-69	440 system for exhaust tips	849.99	set
MB2547	1968-69	440 system w/turndown tail pipes	859.99	set
MB2557	1968-69	383 system for exhaust tips	789.99	set
MB2528	1968-69	383 system w/turndown tail pipes	789.99	set
MB2540	1968-70	426 Hemi w/turndown tail pipes	959.99	set
MB2541	1968-70	426 Hemi w/full t/pipes for ext tips	959.99	set
MB2542	1968-70	426 Hemi w/resonators for tips	1149.99	set
MB2538	1970	440 system for exhaust tips	789.99	set
MB2539	1970	440 system w/turndown tail pipes	789.99	set
MB2555	1970	383 system for exhaust tips	789.99	set
MB2556	1970	383 system w/turndown tail pipes	789.99	set
MB2544	1971	426 system w/resonators	1289.99	set
MB2548	1971-74	440 system for exhaust tips	819.99	set
MB2549	1971-74	440 system w/turndown pipes	959.99	set
MB2559	1971-74	383/400 system for exhaust tips	789.99	set
MB2560	1971-74	383/400 w/turndown tail pipes	789.99	set
MB2561	1971-74	440 system for exhaust tips	789.99	set
MB2562	1971-74	440 system w/turndown pipes	789.99	set
MB2563	1971-74	340/360 system for exhaust tips	789.99	set
MB2564	1971-74	340/360 w/turndown tail pipes	789.99	set

E-Body

ME1720	1970	TA-AAR system w/exhaust tips	859.99	set
ME1721	1970	340 Cuda system	859.99	set
ME1722	1970	340 Challenger system	859.99	set
ME1718	1970-71	426 Hemi Cuda system	1289.99	pr
ME1719	1970-71	426 Hemi Challenger system	1289.99	pr
ME1724	1970-74	383/400 Cuda system	859.99	set
ME1725	1970-74	383/400 Challenger system	859.99	set
ME1726	1974	340 Cuda ME1724 Barrel system	959.99	set
ME1727	1970-74	440 Challenger and Six-Pak system	959.99	set
ME1728	1970-74	318 single Y-pipe system	789.99	set
ME1729	1970-74	318 single Y-pipe sys w/resonator	859.99	set
ME1723	1971-74	340/360 system	859.99	set

1967-71 B & E-Body H-pipes

Replacement H-pipes for various 1967-71 B & E-Body models are engineered to fit and perform as original with nipple tubes welded in place but not drilled out. Features all factory flat spots, torsion bar clearance dents for an accurate appearance and are constructed from heavy 14 gauge aluminized tubing for long life and proper sound control.

Important: All of the exhaust pipes are manufactured to bolt up to the original exhaust manifold. Modifications may be necessary for vehicles with original headers or engine transplants.

Note: Shipped truck freight.



MB2627

B-Body

MB2626	1967	2-1/2" 440/RT or GTX	384.99	ea
MB2627	1968-69	2-1/2" 440	384.99	ea
MB2628	1966-70	2-1/2" 2-1/4" outlet, Hemi	389.99	ea
MB2629	1966-70	2-1/2" 2-1/4" outlet, Hemi cold rolled orig.	559.99	ea
MB2630	1970	2-1/2" 440	384.99	ea
MB2631	1971	2-1/2" 2-1/4" outlet, Hemi	399.99	ea

E-Body

ME5035	1970-71	2-1/2" 2-1/4" outlet, Hemi Cuda	489.99	ea
ME5036	1970-71	2-1/2" 2-1/4" outlet, Hemi Challenger	489.99	ea



MES025

1964-74 Y-pipes

OEM-style pipes which are superior to the coated-style originals. Long-lasting and effective against salt-road winters, these Y-pipes are manufactured to bolt up to the original exhaust manifold and weld to the intermediate pipe. Our Y-pipes are sold as a set with the intermediate pipe.

Note: Shipped truck freight.

A-Body

MA3496	1964-66	2-1/2" hi-po Barracuda/Valiant	369.99	set
MA3497	1965-66	2-1/2" hi-po Dart	369.99	set
MA2436	1967	2-1/2" hi-po Dart/Barracuda	249.99	set
MA2437	1967-74	2-1/4" 273/318	299.99	set

E-Body

ME5025	1970-74	2-1/4" 318	299.99	set
--------	---------	------------	--------	-----



Universal 2-1/2" Connector Set

This is a universal connector that can be used in various locations for the exhaust system. Measures 2-1/2" inner diameter and includes mounting bolts. Each set is enough for a vehicle with dual exhaust.

MD4525 2-1/2" ball joint connector set..... 64.99 set

Exhaust System Components



1962-74 Headpipes

OEM-style headpipes which are superior to the coated-style originals. Long-lasting and effective against salt-road winters and will bolt up to the factory exhaust manifold without any modifications. Sold individually.
Note: Ships track freight.



1962-74 Tailpipes

OEM-style tail pipes which are superior to the coated-style originals. Long-lasting and effective against salt-road winters, these feature correct bends and are available for models with or without tips. Sold individually.
Note: Ships double oversize.

A-Body					
MA2420	1967-74	LH	2-1/4"	273/318	159.99 ea
MA2421	1967-74	RH	2-1/4"	273/318	149.99 ea
MA2422	1968-74	LH	2-1/4"	340/360	174.99 ea
MA2423	1968-70	RH	2-1/4"	340/360	174.99 ea
MA2424	1971-74	RH	2-1/4"	340/360	floating flange 189.99 ea
MA2425	1967-69	LH	2-1/4"	383/440	189.99 ea
MA2426	1967-69	RH	2-1/4"	383/440	189.99 ea
MA2427	1969	LH	2-1/2"	383/440 1-piece	219.99 ea
MA2428	1969	RH	2-1/2"	383/440 1-piece	219.99 ea
MA2429	1967-74		2"	6 cyl 118" WB 2-piece	129.99 ea
MA2430	1967-71		2"	6 cyl 111" WB 1-piece	129.99 ea
MA2431	1967-71		2-1/4"	6 cyl 111" WB 1-piece	149.99 ea

B-Body					
MB2590	1962-65	LH	2-1/4"	361/383	149.99 ea
MB2591	1962-65	RH	2-1/4"	361/383	149.99 ea
MB2592	1962-65	LH	2-1/4"	413/426	149.99 ea
MB2593	1962-65	RH	2-1/4"	413/426	149.99 ea
MB2594	1966-67	LH	2-1/4"	361/383	149.99 ea
MB2595	1966-67	RH	2-1/4"	361/383	149.99 ea
MB2596	1968-69	RH	2-1/4"	383	149.99 ea
MB2597	1968-70	LH	2-1/4"	383	149.99 ea
MB2598	1970	RH	2-1/4"	383	149.99 ea
MB2599	1966-74	LH	2-1/4"	273/318	154.99 ea
MB2600	1966-74	RH	2-1/4"	273/318	154.99 ea
MB2601	1971-74	LH	2-1/4"	340/360	159.99 ea
MB2602	1971-74	RH	2-1/4"	340/360	159.99 ea
MB2603	1971-74	LH	2-1/4"	383/400	149.99 ea
MB2604	1971-74	RH	2-1/4"	383/400	149.99 ea
MB2605	1971-74	LH	2-1/2"	440	159.99 ea
MB2606	1971-74	RH	2-1/2"	440	159.99 ea

E-Body					
ME1732	1970	LH	2-1/4"	TA/AA/R	154.99 ea
ME1733	1970	RH	2-1/4"	TA/AA/R	154.99 ea
ME1734	1970	LH	2-1/4"	340 Cuda	154.99 ea
ME1735	1970	RH	2-1/4"	340 Cuda	154.99 ea
ME1736	1970	LH	2-1/4"	340 Challenger	154.99 ea
ME1737	1970	RH	2-1/4"	340 Challenger	154.99 ea
ME1738	1970-74	LH	2-1/4"	318	179.99 ea
ME1739	1970-74	RH	2-1/4"	318	179.99 ea
ME1740	1970-74	LH	2-1/4"	383/440 Cuda	154.99 ea
ME1741	1970-74	RH	2-1/4"	383/440 Cuda	154.99 ea
ME1742	1970-74	LH	2-1/4"	383/440 Challenger	154.99 ea
ME1743	1970-74	RH	2-1/4"	383/440 Challenger	154.99 ea
ME1744	1970-74	LH	2-1/2"	440 Cuda Six Barrel	179.99 ea
ME1745	1970-74	RH	2-1/2"	440 Cuda Six Barrel	179.99 ea
ME1746	1970-74	LH	2-1/2"	440 Challenger Six Pack	179.99 ea
ME1747	1970-74	RH	2-1/2"	440 Challenger Six Pack	179.99 ea
ME1748	1971-74	LH	2-1/4"	340/360	179.99 ea
ME1749	1971-74	RH	2-1/4"	340/360	179.99 ea



1965-74 A-Body Intermediate Pipe

OEM-style intermediate pipes which are superior to the coated-style originals. Long-lasting and effective against salt-road winters, these intermediate pipes are welded on one end to the y-pipe and to the muffler assembly on the other.
Note: Ships double oversize.

MA2432	1965-66	2-1/2"	273 hi-po	119.99 ea
MA2433	1967-74	2"	318	79.99 ea
MA2434	1967-71	2-1/4"	318 performance pipe	99.99 ea

A-Body					
MA2411	1964-67	LH	2-1/4"	hi-po over axle	57.99 ea
MA2412	1968-74	LH	2-1/4"	with tips	89.99 ea
MA2413	1968-74	RH	2-1/4"	with tips	89.99 ea
MA2414	1968-74	LH	2-1/2"	with tips	99.99 ea
MA2415	1968-74	RH	2-1/2"	with tips	99.99 ea
MA2416	1968-74	LH	2-1/4"	turndown style	89.99 ea
MA2417	1968-74	RH	2-1/4"	turndown style	89.99 ea
MA2418	1968-74	LH	2-1/2"	turndown style	99.99 ea
MA2419	1968-74	RH	2-1/2"	turndown style	99.99 ea

B-Body					
MB2565	1968-70	LH	2-1/4"	with tips	89.99 ea
MB2566	1968-70	RH	2-1/4"	with tips	89.99 ea
MB2567	1968-70	LH	2-1/2"	with tips	99.99 ea
MB2568	1968-70	RH	2-1/2"	with tips	99.99 ea
MB2569	1971-74	RH	2-1/4"	with tips	89.99 ea
MB2570	1971-74	LH	2-1/4"	with tips	89.99 ea
MB2571	1971-74	RH	2-1/2"	with tips	99.99 ea
MB2572	1971-74	LH	2-1/2"	with tips	99.99 ea
MB2573	1966-67	RH	2-1/4"	turndown style	89.99 ea
MB2574	1966-67	LH	2-1/4"	turndown style	89.99 ea
MB2575	1968-70	LH	2-1/2"	turndown style	89.99 ea
MB2576	1968-70	RH	2-1/4"	turndown style	89.99 ea
MB2577	1968-70	RH	2-1/2"	turndown style	99.99 ea
MB2578	1968-70	LH	2-1/2"	turndown style	99.99 ea
MB2579	1971-74	RH	2-1/4"	turndown style	89.99 ea
MB2580	1971-74	LH	2-1/4"	turndown style	89.99 ea
MB2581	1971-74	RH	2-1/2"	turndown style	99.99 ea
MB2582	1971-74	LH	2-1/2"	turndown style	99.99 ea
MB2583	1962	LH	2-1/4"	Max Wedge turndown	89.99 ea
MB2584	1962	RH	2-1/4"	Max Wedge turndown	89.99 ea
MB2585	1963-65	LH	2-1/4"	Max Wedge turndown	89.99 ea
MB2586	1963-65	RH	2-1/4"	Max Wedge turndown	89.99 ea
MB2587	1967	LH	2-1/4"	GT-X	89.99 ea
MB2588	1967	RH	2-1/4"	GT-X	89.99 ea
MB2607	1968-74	LH	2-1/4"	over axle pipe	59.99 ea
MB2608	1968-74	RH	2-1/4"	over axle pipe	59.99 ea

E-Body					
ME1730	1970-74	RH	2-1/4"	over axle pipe	64.99 ea
ME1731	1970-74	LH	2-1/4"	over axle pipe	64.99 ea

New!



Tru-X & Y Pipes

The more gentle radius of these x and y pipes allow for better exhaust gas scavenging, noise cancellation and better balance between cylinder banks. The result is a significant increase in power and torque, but a reduction in db sound levels.

X-Pipe					
10781	2-1/2"	dual in/out x 9.5"	long	109.99 ea	
10782	3"	dual in/out x 13.2"	long	114.99 ea	
Crossover					
10790	2-1/4"	dual in/out x 12"	long	99.99 ea	
10791	2-1/2"	dual in/out x 12"	long	99.99 ea	
10792	3"	dual x in/out x 14"	long	104.99 ea	
Y-Pipe					
10748	2-1/2"	single side, 2"	dual side	31.99 ea	
10758	2-1/2"	single side, 2-1/4"	dual side	31.99 ea	
10768	2-1/2"	single side, 2-1/2"	dual side	31.99 ea	
10778	3"	single side, 2-1/2"	dual side	31.99 ea	
10798	3"	pipe, 3"	dual side	31.99 ea	

Restoration Exhaust Components



MA2438



MA2439



MA2440



MA2441



MA2461



MA2438



MB2620



MB2621



MB2622

1962-74 A & B-Body OE-Style Replacement Mufflers

Our OE-style mufflers feature a long-lasting double wrapped aluminized finish that's effective against salt-road winters. Manufactured to perform exactly as original and produce the correct sound tone, these mufflers are also the closest to the original in appearance available. High performance mufflers feature a two-pass three-chamber design that allows for improved exhaust flow and a slightly more aggressive tone. Correct for 340, 383 and 440 (M code) applications and feature flat corner dents that the factory added for clearance.

Note: Any engine modifications will alter the sound of the muffler.

		A-Body			
Single Exhaust		inlet	outlet		
MA2438	1965-66	2-1/2"	2-1/4"	273 4bbl hi-po, replacement	114.99 ea
MA2439	1963-74	2"	1-7/8"	18" case, replacement	99.99 ea
Dual Exhaust					
MA2440	1967-74	2-1/4"	2-1/4"	18" case, replacement	99.99 ea
MA2441	1967-74	2-1/2"	2-1/4"	18" case, replacement	99.99 ea
MA2461	1967-74	2-1/4"	2-1/4"	performance	119.99 ea
MA2438	1967-74	2-1/2"	2-1/4"	performance	114.99 ea

		B-Body			
MB2619	1962-64	2-1/2"	2-1/4"	Max Wedge, replacement	104.99 ea
MB2620	1966-74	2-1/4"	2-1/4"	replacement	99.99 ea
MB2621	1966-74	2-1/2"	2-1/4"	Hemi, replacement	94.99 ea
MB2622	1966-74	2-1/2"	2-1/4"	Hemi, performance	104.99 ea



ME5029



ME5033

1970-74 E-Body Mufflers

Mufflers for all 1970-74 Barracuda and Challenger models. Features correct mounting locations as original and inner construction to produce the same great sound and tone as the original.

ME5029	1970	LH/RH	TA/AAR	109.99 ea
ME5030	1970-74	LH	w/rear tips	114.99 ea
ME5031	1970-74	RH	w/rear tips	114.99 ea
ME5032	1970-74	LH	turndown	179.99 ea
ME5033	1970-74	RH	turndown	169.99 ea



1968-76 A & B-Body Resonators

These resonators for 1968-74 B-Body and 1975-76 A-Body models have been manufactured to factory specifications to look, fit, and sound like factory originals. Fits 1968-70 Hemi B-Body models and 1971-74 B and 1975-76 A-body models with the deluxe sound insulation package. Mounts behind the rear axle.
MB2623 1968-76 2-1/4" 99.99 ea



MN2343



MN2351



MN2350

1962-70 Date Coded Mufflers

These date coded mufflers are for restorers who demand originality. These aluminized mufflers are the correct gauge metal with the correct date code, original part number, and Pentastar logo (except where noted). All mufflers measure 2-1/4" inlet and outlet.

*Note: *Does not feature Pentastar logo.*

Original Muffler Part #2208406	
MN2351 1962-65 dated 10-61	79.99 pr
Original Muffler Part #2781300	
MN2343* 1966-70 dated 09-67	149.99 pr
MN2344* 1966-70 dated 09-68	149.99 pr
MN2345 1966-70 dated 09-67	179.99 pr
MN2346 1966-70 dated 09-68	179.99 pr
MN2348 1966-70 dated 11-70	179.99 pr
MN2349 1966-70 dated 01-71	179.99 pr
Original Muffler Part #3466913	
MN2350* 1970 AAR/TA, dated 02-70	239.99 pr



MB1511

1968-70 B-Body Resonator Assembly

Replacement tailpipe and resonator assembly for 1968-70 Hemi-powered B-Bodies with over-the-axle exhaust. These assemblies are the original length and dimensions for a correct restoration. The pipe is made from heavy 14 gauge aluminized material and the resonators are fully aluminized for great appearance and long life.
MB1511 1968-70 RH 179.99 ea
MB1512 1968-70 LH 179.99 ea

Restoration Exhaust Components

New!



MP700110



MP700111



MP700112



MP700120



MP700130

Exact Reproduction Exhaust Components

These highly detailed reproduction mufflers and resonators are manufactured to original specifications from the factory plans to provide an authentic appearance and sound. They feature correct factory embossed markings with licensed Pentastar logo, crimps, spot welds, internal baffles, and brackets, and are available with multiple factory date codes. Made in USA.

Note: Sold in pairs.

B-Body Mufflers

7/23/1968 Production Date	
MP700110 1968-69 code 2058	799.99 pr
1/27/1969 Production Date	
MP700111 1969-70 code 0279	799.99 pr
7/24/1969 Production Date	
MP700112 1970 code 2059	799.99 pr

E-Body Resonators

7/02/1969 Production Date	
MP700120 1970 code 2049	599.99 pr
7/15/1970 Production Date	
MP700121 1971 code 1966	599.99 pr

E-Body Mufflers w/Over Axle Pipe

Production Date: 7/02/1969 LH, 7/7/1969 RH	
MP700130 1970 codes 1839/1889 969.99 pr	
Production Date: 7/20/1970 LH, 7/08/1970 RH	
MP700131 1971 codes 2010/1890.....	969.99 pr



1970-74 E-Body Resonators

Resonators for 1970-74 Barracuda and Challenger models. Manufactured to factory specifications to look and sound exactly like factory original resonators. These resonators mount forward of the rear axle for non TA/AAR models. Made in USA.

ME5034 1970-74 E-Body 79.99 ea



MN2352



MN2357

1965-74 Date Coded Resonators

These date coded resonators are for the restorers who demand originality. Includes the correct Pentastar logo (except where noted). Made from aluminumized steel. Note: *Includes over-axle tailpipe. **Includes exhaust tip. †Does not feature Pentastar logo.

A-Body - Barracuda

MN2352** 1965-67 dated 09-65..... 239.99 ea

B-Body w/Hemi or 440 HP

MN2353 1966-70 dated 09-67..... 289.99 pr

MN2354 1966-70 dated 09-69..... 289.99 pr

MN2355 1966-70 dated 09-70..... 289.99 pr

MN2356* 1966-70 dated 09-67..... 369.99 pr

MN2357* 1966-70 dated 09-69..... 369.99 pr

MN2358* 1966-70 dated 09-70..... 369.99 pr

E-Body

MN2360 1970-74 dated 08-69..... 189.99 pr

MN2359† 1970-74 dated 11-12-69..... 109.99 pr



1970-74 E-Body Muffler Heat Shields

Muffler heat shield for all 1970-74 Barracuda and Challenger models. E-Body muffler heat shields are mounted to the trunk floor above the muffler. Features correct contours to fit exactly as original.

ME5038 1970-74 heat shields 54.99 pr



1970 AAR/TA Muffler Straps

Muffler straps for 1970 AAR Cuda and Challenger T/A models. These straps attach to each of the mufflers and secure them to the floor hangers.

ME5037 1970 TA/AAR 34.99 pr



1971 B-Body Resonator Straps

Resonator straps hold the resonators and give them additional support. Will fit all 1971 B-Body models.

MB2638 1971 resonator straps..... 46.99 pr



MD4526

Exhaust Tip Q-Clamps

Q-clamps for various Mopar vehicles. Q-clamps were installed at the rear of the vehicle to secure the exhaust tips to the tailpipes.

MD4526 2 1/4" zinc coated..... 19.99 ea



E244

Stainless Steel Clamps

Stainless or plated exhaust clamps now available for chambered or aluminumized exhaust systems. Stainless or plated clamps offer long-lasting effectiveness over the original style non-coated clamps.

E240 2" clamp stainless..... 16.99 ea

E241 2-1/4" clamp stainless..... 19.99 ea

E242 2-1/2" clamp stainless..... 19.99 ea

E243 2" clamp plated..... 4.99 ea

E244 2-1/4" clamp plated..... 4.99 ea

E245 2-1/2" clamp plated..... 1.99 ea

Performance Exhaust

New!

DOUG'S HEADERS



25052

Doug's Stainless Steel Electric Cutoffs

These cut-outs feature a rugged 12 volt DC motor and rotating gate for a leak-proof seal every time the cut-out is opened and closed. When fully opened, these cut-outs do not create exhaust flow obstructions that can create a leaky gasket sound, unlike butterfly-style cutouts. A pre-wired harness with an illuminated rocker switch is supplied for easy installation. Uncork your exhaust with the flip of a switch from your dash. The cut-outs are ideal for race tracks that don't require mufflers. These Doug's cut-outs are available individually, in pairs, or in complete kits with Y-Pipes for easy installation. Made in USA.

Note: May not be legal for highway use or use on emission controlled vehicles.

Important: Not recommended for vehicles equipped with catalytic converters.

Key Features:

- 304 stainless steel construction
- High torque 12 Volt DC gear reduction motors
- Self adjusting/cleaning gate for leak proof seal
- Zero obstructions when fully open
- Harness pre-wired for easy installation
- Small size permits greater installation options
- Includes wiring harness, gaskets and hardware
- Cutout kits include Y-pipe & band clamps

25052	2-1/2"	single cutout	209.99 ea
25053	2-1/2"	pair of cutouts	389.99 pr
25054	2-1/2"	complete cutout kit	455.99 pr
25055	3"	single cutout	209.99 ea
25056	3"	pair of cutouts	389.99 pr
25057	3"	complete cutout kit	439.99 set

Electric Exhaust Cutoffs

Available in sizes 2-1/4" to 4" and a low profile oval design for applications with limited ground clearance. Fits 2-1/4" to 3" round exhaust pipe. Built with high quality materials- CNC 6061 aluminum body and motor plate, stainless steel shaft and butterfly plate, high torque DC gear driven motor, weather-tight wiring connectors, and custom illuminated toggle switch.



MN2446

Important: Match valve size with cutoff size for optimal fit and performance.

Note: * Includes connector, fits 2-1/2" to 3" round pipe.

** Includes 4" three-bolt flange

Electric Cutoff Valves - Individual

MN2443	2-1/4"	valve	181.99 ea
MN2444	2-1/2"	valve	179.99 ea
MN2445	3"	valve	179.99 ea
MN2446*	oval	valve	199.99 ea
MN2447	3-1/2"	valve	179.99 ea
MN2448	4"	valve	199.99 ea
MN2449**	4"	valve	219.99 ea

Electric Cutoff Valve Sets

MN2450	two 2-1/4"	valves	354.99 pr
MN2451	two 2-1/2"	valves	354.99 pr
MN2452	two 3"	valves	354.99 pr
MN2453*	two oval	valves	419.99 pr
MN2454	two 3-1/2"	valves	354.99 pr
MN2455	two 4"	valves	399.99 pr
MN2456**	two 4"	valves	439.99 pr



MN2457

MN2459

Universal Exhaust Turn-Downs

Universal exhaust turn-downs for electric cutouts. They feature a 360° floating flange which allows turning in any direction. Manufactured from stainless steel with a polished finish.

MN2457	2-1/2"	turn-down	26.99 ea
MN2458	3"	turn-down	26.99 ea
MN2459	oval	turn-down	21.99 ea



MN2460

Stainless Steel Cutout Pipes

Stainless steel exhaust cutout pipes for all models. Manufactured from 304 stainless steel with a polished finish. They feature a TIG-welded construction with a 3/8" flange for a proper seal. Includes the end cap, gasket and hardware for an easy installation.

MN2460	2-1/4"	cutout	51.99 ea
MN2461	2-1/2"	cutout	51.99 ea
MN2462	3"	cutout	51.99 ea
MN2463	3-1/2"	cutout	51.99 ea
MN2464	4"	cutout	81.99 ea



Electric Cutoff Remote Control System

Remote control for your electric cutoff system. When space is a premium this control box gives you the flexibility you need. Includes 2 wireless key fobs for 100% control over your cutouts at the push of a button.

MN2466	remote control	84.99 set
--------	----------------	-----------

New!

DOUG'S HEADERS



25059

Doug's Stainless Steel Cutoff Turn Downs

Easily route your cutoff exhaust flow away from the floor boards or in any direction with these easily-installed 304 stainless steel turn downs. These turn downs are made specifically for Doug's electric cutouts and included stainless band clamps for weld free attachment. Made in the USA.

25058	2-1/2"	turndown pipe	34.99 ea
25059	3"	turndown pipe	34.99 ea

NEW WARRANTY

EVES



Street Pro Mufflers

This is a great street/strip muffler that will maintain its rich sound qualities for the life of the muffler because there is no filter to burn off. Recommended for stock to medium modified vehicles where an aggressive sound is appreciated without demanding undesirable attention. Muffler shell measures 4" x 9" x 14" long. Limited lifetime warranty.

409 Stainless Steel

P1021	2.5"	offset/offset	69.99 ea
P1022	2.5"	offset/center	69.99 ea
P1023	3"	offset/offset	69.99 ea
P1024	3"	offset/center	69.99 ea

NEW WARRANTY

EVES



Race Pro Mufflers

Race Pro Muffler features a "straight through" path with throughput that can flow 95% as efficiently as a straight pipe! At idle and low RPM cruising, you will not draw much attention, but upon acceleration, bystanders look out! The Race Pro's aggressive sound is the result of applying a layer of stainless mesh around a unique internal perforated tube, accompanied by a healthy stuffing of basalt insulation before the unit is sealed. Muffler shell measures 4" x 9" x 14" long, except P1037 M-80 muffler which is 4" round x 14" long. Limited lifetime warranty.

409 Stainless Steel

P1029	2.5"	offset/offset	71.99 ea
P1030	2.5"	offset/center	69.99 ea
P1031	3"	offset/offset	69.99 ea

304 Polished Stainless Steel

P1033	2.5"	offset/offset	84.99 ea
P1034	2.5"	offset/center	84.99 ea

NEW WARRANTY

EVES



Violator Mufflers

The Violator's aggressive sound is the result of a unique internal lowered tube with mini sound deflector chambers. Finally, a muffler that flows like a straight through muffler but sounds like a chambered muffler. Muffler shell measures 4" x 9" x 14" long. Limited lifetime warranty.

409 Stainless Steel

P1038	2.5"	offset/offset	69.99 ea
P1039	2.5"	offset/center	69.99 ea
P1040	3"	offset/center	69.99 ea

Performance Mufflers

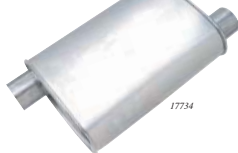

Dynomax Universal Fit Super Turbo Muffler

The Dynomax Super Turbo muffler has exclusive patented flow directors to channel exhaust flow and eliminate turbulence, larger diameter internal tubes for maximum flow, along with fiberglass matting that delivers a mellow, true performance sound. Made of all aluminum materials, double-wrapped and arc-welded for longer life and sharper appearance. All universal mufflers are reversible for custom installation.

Important: This muffler comes in two styles. Sport model from 2" to 2-1/2" measures 4" x 9-3/4" x 18-1/2" and 3" measures 4" x 9-3/4" x 20". Street model measures 4" x 9-3/4" x 25-1/2".

Sport

17730 2"	inlet offset/center outlet ..	79.99 ea
17736 2"	inlet offset/offset outlet ..	84.99 ea
17731 2-1/4"	inlet offset/center outlet ..	69.99 ea
17732 2-1/4"	inlet offset/offset outlet ..	69.99 ea
17733 2-1/2"	inlet offset/center outlet ..	69.99 ea
17734 2-1/2"	inlet offset/offset outlet ..	69.99 ea
17797 2-3/4"	inlet offset/center outlet ..	109.99 ea
17744 3"	inlet offset/center outlet ..	69.99 ea
17743 3"	inlet offset/offset outlet ..	69.99 ea

Street

17747 2-1/4"	inlet center/offset outlet ..	89.99 ea
17767 2-1/4"	inlet offset/center outlet ..	119.99 ea
17748 2-1/2"	inlet center/offset outlet ..	89.99 ea
17749 2-1/2"	inlet offset/offset outlet ..	99.99 ea
17758 2-1/2"	inlet cnt/offset 2 outlet ..	119.99 ea



THRUSSH Glasspack Mufflers

Thrussh has long been the industry leader in glasspack mufflers. They have a straight-through, smooth-flowing perforated center tube design for maximum flow and power. All Thrussh mufflers are made with heavy-duty gauge shell for durability. Thrussh mufflers come with expandable bushings for custom applications. Enjoy the unmistakable sound of a Thrussh glasspack muffler today. Dimensions: overall length x shell length x shell diameter.

24200 2"	25" x 20" x 3-1/2" ...	39.99 ea
24202 2"	27" x 22" x 3-1/2" ...	39.99 ea
24204 2"	31" x 26" x 3-1/2" ...	44.99 ea
24201 2-1/4"	25" x 20" x 3-1/2" ...	44.99 ea
24203 2-1/4"	27" x 22" x 3-1/2" ...	39.99 ea
24205 2-1/4"	31" x 26" x 3-1/2" ...	44.99 ea
24214 2-1/2"	28" x 23" x 4"	39.99 ea
24213 2-1/2"	45" x 40" x 4"	64.99 ea



Dynomax Ultra Fit Ultra Flo SS Muffler

The Dynomax Ultra Flo muffler uses a unique straight through design that maximizes flow and power. Made from all stainless steel materials for a longer life. Continuous perfor design maximizes sound absorption and gives a deep powerful true performance sound. All universal mufflers are reversible for custom installation.

Important: This muffler comes in two styles. Sport model measures 4" x 9-3/4" x 18-1/2". Street model measures 4" x 9-3/4" x 25-1/2".

Sport

17282 2-1/4"	inlet offset/center outlet ...	119.99 ea
17271 2-1/4"	inlet offset/offset outlet ...	114.99 ea
17283 2-1/2"	inlet offset/center outlet ...	119.99 ea
17519 3"	inlet cnt/2-1/2" offset dual outlet	119.99 ea

Street

17289 2-1/2"	inlet offset/center outlet ...	264.99 ea
--------------	--------------------------------	-----------



Terminator Muffler

Flowtech's Terminator is constructed entirely of super-thick, black aluminum steel, fully welded for strength and durability with 3" inner pass tubes that reduce back pressure and increase horsepower like no other muffler can. Available for universal fit applications. Dimensions: 15" x 11" x 5".

Universal Fit

50121 2-1/4"	center/offset	81.99 ea
50122 2-1/2"	center/offset	81.99 ea
50130 3"	center/offset	81.99 ea



Universal Fit Raptor Muffler

Flowtech's new Raptor turbo performance muffler features a unique sound rich case design and aluminum, lock seal construction. The Raptor has low restriction, reduces back pressure and increases performance. It offers high-gain, high-output flow tubes to provide more horsepower, better mileage and a sound of pure performance. Dimensions 13" x 10" x 4-1/2" with offset-inlet/center-outlet.

50050 2"	29.99 ea
50051 2-1/4"	29.99 ea
50052 2-1/2"	29.99 ea



Magnaflo Glasspack Mufflers

Magnaflow Glass Pack Mufflers feature a free-flowing, straight-through perforated core, and Rockwool acoustical packing material to deliver that smooth, deep tone unlike some others' products to ensure long life and no sound degradation over time.

18124 2"	22" x 18" x 3.5"	69.99 ea
18134 2"	26" x 22" x 3.5"	79.99 ea
18144 2"	30" x 26" x 3.5"	84.99 ea
18125 2.5"	22" x 18" x 3.5"	34.99 ea
18135 2.5"	26" x 22" x 3.5"	79.99 ea
18145 2.5"	30" x 26" x 3.5"	84.99 ea
18146 2.5"	30" x 26" x 4"	89.99 ea
18129 3"	22" x 18" x 4"	46.99 ea



11224

Magnaflo 4" x 9" Oval Mufflers

Magnaflow's wide-open performance mufflers outflow OEM chamber style mufflers by as much as 167%! This reduces engine heat and back pressure and improves exhaust scavenging from the combustion chamber. Magnaflow minimizes the power robbing effects of the OEM system to restore torque and horsepower to the engine. Magnaflow is the straight through, wide-open performance muffler with a smooth, deep tone. These mufflers offer a reversible inlet/outlet design.

Stainless Steel Muffler 4" x 9"

11224 14"	2" inlet/outlet	84.99 ea
11225 14"	2.25" inlet/outlet	84.99 ea
11226 14"	2.5" inlet/outlet	84.99 ea
11229 14"	3" inlet/outlet	99.99 ea

Polished Stainless Steel Muffler 4" x 9"

114324 14"	2" inlet/outlet	114.99 ea
114325 14"	2.25" inlet/outlet	114.99 ea
114326 14"	2.5" inlet/outlet	114.99 ea
114329 14"	3" inlet/outlet	124.99 ea



Magnaflo Wide-Open Dual Outlet Mufflers

Reduce engine heat and back pressure and improves exhaust scavenging from the combustion chamber. Magnaflow minimizes the power robbing effects of the OEM system to restore torque and horsepower to the engine. Magnaflow is the straight through, wide-open performance muffler with the smooth, deep tone. Designed for applications where the muffler must be mounted transversely behind the rear axle.

Aluminized Steel Dual Outlet Muffler 5" x 8"

12266 18"	2.5" inlet, 2.25"	119.99 ea
12265 18"	2.5" inlet, 2.5"	119.99 ea
12267 18"	3" inlet, 2.5"	119.99 ea

Stainless Dual Outlet Muffler 5" x 8" Oval

14266 18"	2.5" inlet, 2.25"	161.99 ea
14277 18"	2.5" inlet, 2.5"	161.99 ea
14288 18"	3" inlet, 2.5"	169.99 ea

FLOWMASTER
PERFORMANCE MUFFLERS

Performance Mufflers

FLOWMASTER Super 40 American Thunder

The Super 40 5" x 10" case design gives you a deeper tone that retains our classic 40 Series sound and feel. Increased flow path radius for optimum internal flow using the latest in Delta Flow technology. Flowmaster state-of-the-art robot assembly technology assures a product that exceeds OEM auto manufacturers' specifications. To achieve such critical quality, Flowmaster performs extensive R&D at the track and in-house with our own engine and chassis dyno facilities. Flowmaster Super 40 is aluminumized, black in color and is the most aggressive, deepest-sounding street two chamber muffler they've ever built. Enjoy some American Thunder today!



Part No.	Size	Description	Price
FY52445	2-1/4"	center in/center outlet	97.99 ea
FY52446	2-1/4"	offset in/center outlet	97.99 ea
FY52447	2-1/4"	center in/offset outlet	97.99 ea
FY52448	2-1/4"	offset in/opposite offset outlet	97.99 ea
FY52545	2-1/2"	center in/center outlet	97.99 ea
FY52546	2-1/2"	offset in/center outlet	97.99 ea
FY52547	2-1/2"	center in/offset outlet	97.99 ea
FY52548	2-1/2"	offset in/opposite offset outlet	97.99 ea
FY52549	2-1/2"	offset in/same offset outlet	97.99 ea
FY53045	3"	center in/center outlet	97.99 ea
FY53046	3"	offset in/center outlet	97.99 ea
FY53047	3"	center in/offset outlet	97.99 ea
FY53048	3"	offset in/opposite offset outlet	97.99 ea

Flowmaster's Super HP-2 Mufflers

New!

Designed for street rods, customs and vehicles where underchassis space is tight, the Flowmaster Super HP-2 provides the exhaust performance you need in a compact package that fits wherever you need it. The Super HP-2 has a moderate tone with the appearance, durability, and unique control to suit daily drivers, weekend cruisers, and work class show vehicles. Available with a 409S stainless steel case or polishable 304S stainless steel case in sizes from 2", 2-1/4" and 2-1/2". Made in USA



Part No.	Size	Description	Price
F1212409	2"	in/out 4"H x 5"W x 12"L body	114.99 ea
F12018409	2"	in/out 4"H x 5"W x 18"L body	144.99 ea
F12412409	2-1/4"	in/out 4"H x 5"W x 12"L body	114.99 ea
F12418409	2-1/4"	in/out 4"H x 5"W x 18"L body	144.99 ea
F12512409	2-1/2"	in/out 4"H x 5"W x 12"L body	114.99 ea
F12518409	2-1/2"	in/out 4"H x 5"W x 18"L body	144.99 ea
409S Stainless Steel Case			
F12412304	2-1/4"	in/out 4"H x 5"W x 12"L body	144.99 ea
F12418304	2-1/4"	in/out 4"H x 5"W x 18"L body	184.99 ea
F12512304	2-1/2"	in/out 4"H x 5"W x 12"L body	144.99 ea
F12518304	2-1/2"	in/out 4"H x 5"W x 18"L body	184.99 ea

Flowmaster Super 10 Series Stainless Steel Mufflers

New!

Looking for the most aggressive sound available? Flowmaster's new Super 10 series mufflers are so aggressive, they aren't recommended for street driven vehicles. Best suited to racing applications, these feature the same performance technology used in the Super 40 and Super 44 series Flowmaster mufflers. These short, single chamber mufflers deliver the closest thing to open pipe sound possible. If you want high impact sound, the Super 10 series mufflers are the answer. Measures 6.5" x 9.5"



Part No.	Size	Description	Price
F842515	2-1/2"	center inlet/center outlet	75.99 ea
F8425152	2.5"/2.25"	center inlet/center outlet	75.99 ea
F842518	2.5"	offset in/offset outlet	75.99 ea
F843015	3"	center inlet/center outlet	75.99 ea
F8430152	3"/2.5"	center inlet/dual outlet	75.99 ea

FLOWMASTER 40 Series Performance Mufflers

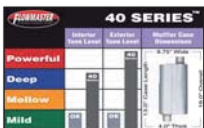

- Aluminumized Steel
- Original Flowmaster Tone
- Deep Tone Inside Vehicle
- Street or Strip

Flowmaster 40 Series-Original Flowmaster Tone

This is the most "aggressive" sounding street/strip muffler that Flowmaster offers. If you're looking for attention, this one will get you noticed. The standard 40 series has an "aggressive rumble" and will generally resonate inside the vehicle around 1800-2000 rpm's and again at 2400-2600 rpm's. Constructed of 16 gauge aluminumized steel and fully mig-welded for maximum durability.

FLOWMASTER Delta Flow 40 Performance Mufflers

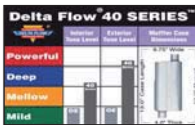

- T409 Stainless Steel
- Powerful Aggressive Tone
- Lower Interior Resonance
- Street or Strip

Flowmaster Delta Flow 40 Series-Reduced Interior Resonance

This two chamber design incorporates Flowmaster's patented "Delta Flow" technology. The "Delta" deflectors result in increased scavenging for better performance and reduced interior resonance over the standard 40 series with a nice growl outside the vehicle. Sounds great on late model performance cars with catalytic converters. Constructed of 16 gauge steel and fully mig-welded for maximum durability.

F842440	2.25"	center inlet/center outlet	109.99 ea
F842541	2.5"	offset inlet/center outlet	111.99 ea
F843041	3"	offset in/center outlet	111.99 ea
F842443	2.25"	offset in/offset outlet	109.99 ea
F842543	2.5"	offset in/offset outlet	111.99 ea



Performance Mufflers

FLOWMASTER Super 44 Delta Flow Mufflers



FLOWMASTER Super 44 Delta Flow

The Super 44 is the most aggressive, deepest toned street and strip muffler Flowmaster has ever made! The Super 44's offer maximum performance, an improved flow path radius and generates more torque and more power than ever before! If you really want to hear your exhaust system inside as well as outside, the Super 44 is for you!

F942445	2-1/4"	center inlet/center outlet	86.99 ea
F942446	2-1/4"	offset inlet/center outlet	86.99 ea
F942447	2-1/4"	center inlet/offset outlet	86.99 ea
F942448	2-1/4"	offset inlet/opposite offset outlet	86.99 ea
F942449	2-1/4"	offset inlet/same offset outlet	86.99 ea
F942545	2-1/2"	center inlet/center outlet	86.99 ea
F942546	2-1/2"	offset inlet/center outlet	86.99 ea
F942547	2-1/2"	center inlet/offset outlet	86.99 ea
F942548	2-1/2"	offset inlet/opposite offset outlet	86.99 ea
F942549	2-1/2"	offset inlet/same offset outlet	86.99 ea
F943045	3"	center inlet/center outlet	86.99 ea
F943046	3"	offset inlet/center outlet	86.99 ea
F943047	3"	center inlet/offset outlet	86.99 ea
F943048	3"	offset inlet/opposite offset outlet	86.99 ea
F943049	3"	offset inlet/same offset outlet	86.99 ea
F9430452	3"	center inlet/dual outlet	86.99 ea

Flowmaster 50 Series SUV-Performance Mufflers

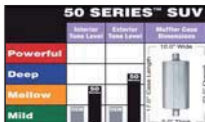

- Large Displacement Street Cars
- Early Era Muscle Cars
- Deep Tone Outside Of Vehicle



Flowmaster 50 Series SUV-Performance

The SUV/Performance muffler is a larger version of Flowmaster's 50 Series Delta Flow muffler and is specially designed for trucks, light SUVs and high horsepower vehicles. The larger H-Chamber reduces interior resonance to a minimum. Constructed of 16 gauge aluminum steel and fully mig-welded for maximum durability.

F52555	2.5"	center inlet/center outlet	141.99 ea
F52556	2.5"	offset inlet/center outlet	141.99 ea
F52557	2.5"	center inlet/offset outlet	141.99 ea
F52558	2.5"	offset inlet/offset outlet	141.99 ea
F53055	3"	center inlet/center outlet	141.99 ea
F53056	3"	offset inlet/center outlet	141.99 ea
F53057	3"	center inlet/offset outlet	141.99 ea
F53058	3"	offset inlet/dual outlet	141.99 ea

FLOWMASTER 50 Series Performance Mufflers

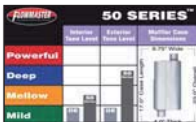

- T409 Stainless Steel
- Milder Performance Sound
- Lower Interior Resonance
- Performance Street

Flowmaster Delta Flow 50 Series-Milder Interior & Exterior Tone

This is the latest design of the 50 series muffler that utilizes Flowmaster's patented "Delta Flow" technology along with an "H-Chamber" to eliminate most all interior resonance and still have that famous Flowmaster sound outside the vehicle. Constructed of 16 gauge steel and fully mig-welded for maximum durability.

F842450	2.25"	center inlet/center outlet	121.99 ea
F842451	2.25"	offset inlet/center outlet	124.99 ea
F842551	2.5"	offset inlet/center outlet	124.99 ea
F843051	3"	offset inlet/center outlet	124.99 ea
F842452	2.25"	center inlet/offset outlet	124.99 ea
F842453	2.25"	offset inlet/offset outlet	124.99 ea
F842553	2.5"	offset inlet/offset outlet	124.99 ea

FLOWMASTER 80 Series Performance Mufflers

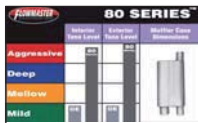

- Aluminized Steel
- Aggressive Performance Sound
- Higher Interior Resonance
- Transverse Mounting

Flowmaster Cross Flow 80 Series-Transverse Mounting

The 80 Series is designed for applications where the muffler must be mounted transversely (cross-flow) behind the rear end. It provides an aggressive muscle car sound both inside and outside the vehicle. Constructed of 16 gauge aluminum steel and fully mig-welded for maximum durability.

F42582	2.5"	dual inlet/dual outlet 4" x 9.75" x 24"	144.99 ea
F42583	2.5"	single inlet/dual outlet 4" x 9.73" x 21"	119.99 ea
F43083	3/2.5"	single inlet/dual outlet 4" x 9.73" x 21"	119.99 ea
F53083	3/2.5"	single inlet/dual outlet 5" x 10" x 23"	144.99 ea

Performance Mufflers

New!

Dr. Gas!
Exhaust Corporation



A7700144

Dr. Gas Frame Clearance Tubes

Frame clearance tubes allow you to route your exhaust through tight areas under cross-members and frame rails. They are designed with round openings and a larger-diameter low-profile oval center section that gives extra clearance without a loss of cross-sectional area or flow. Available for 2.5", 3", or 3.5" diameter pipe. Made in USA.

A7700144	2.5"	clearance tube	99.99 ea
A7700145	3"	clearance tube	109.99 ea
A7700146	3.5"	clearance tube	109.99 ea

New!

Dr. Gas!
Exhaust Corporation



A7700147

Dr. Gas FreqMod Heavy Duty Muffler

Dr. Gas FreqMod Heavy Duty mufflers are designed for severe applications such as high horsepower engines running headers, superchargers or large single exhaust systems. The patented two stage design reduces popping and rasp for a mellow tone while maintaining a very high flow rate. Mufflers are available in high temperature black and copper colored finishes. Made in USA.

2.5" Center Inlet/Offset Outlet

A7700147	black	14" x 10" x 3.5"	134.99 ea
A7700148	copper	14" x 10" x 3.5"	139.99 ea

3" Center Inlet/Offset Outlet

A7700149	black	14" x 10" x 3.5"	139.99 ea
A7700150	copper	14" x 10" x 3.5"	144.99 ea
A7700151	black	14" x 10" x 4.5"	149.99 ea
A7700152	copper	14" x 10" x 4.5"	154.99 ea

3.5" Center Inlet/Offset Outlet

A7700153	black	14" x 10" x 4.5"	159.99 ea
A7700154	copper	14" x 10" x 4.5"	164.99 ea

New!

Dr. Gas!
Exhaust Corporation



A7700183

A7700184

Dr. Gas SpinPro 4-Trap Square Muffler

The compact four-trap square muffler offers the smooth flow and throaty exhaust sound of the Dr. Gas SpinPro mufflers in a square design that fits into tight spaces. They feature an extremely rugged construction and are available in two case thicknesses with high temperature black and copper colored finishes. Made in USA.

2.5" Center Inlet/Center Outlet

A7700183	black	9.5" x 9.5" x 3.25"	129.99 ea
A7700184	copper	9.5" x 9.5" x 3.25"	133.99 ea

3" Center Inlet/Center Outlet

A7700185	black	9.5" x 9.5" x 4.25"	139.99 ea
A7700186	copper	9.5" x 9.5" x 4.25"	143.99 ea

New!

Dr. Gas!
Exhaust Corporation



A7700155

Dr. Gas FreqMod Muffler

Make your V-8 sound like an exotic sports car! Dr. Gas FreqMod mufflers modify the frequency to increase the pitch of your exhaust note. They should be used with an x-pipe for best results. Intended for extreme or race applications. Mufflers are available in high temperature black and copper colored finishes. For quieter application use Heavy Duty FreqMod mufflers. Made in USA.

2.5" Offset Inlet/Center Outlet

A7700155	black	8.5" x 8.5" x 3.25"	129.99 ea
A7700156	copper	8.5" x 8.5" x 3.25"	133.99 ea

3" Offset Inlet/Center Outlet

A7700157	black	9.5" x 9.5" x 4.25"	139.99 ea
A7700158	copper	9.5" x 9.5" x 4.25"	143.99 ea

New!

Dr. Gas!
Exhaust Corporation



A7700159

Dr. Gas SpinPro Reverse Flow Muffler

Dr. Gas SpinPro Reverse-Flow mufflers feature inlets and outlets on the same end. Perfect for side-exit systems with Boom Tube tips or where special routing is required. They are available in high temperature black and copper colored finishes. Made in USA.

2.5" Offset Inlet/Offset Outlet

A7700159	black	11.75" x 8.75" x 3.75"	129.99 ea
A7700160	copper	11.75" x 8.75" x 3.75"	134.99 ea

3" Offset Inlet/Offset Outlet

A7700161	black	11.75" x 8.75" x 3.75"	129.99 ea
A7700162	copper	11.75" x 8.75" x 3.75"	134.99 ea

New!

Dr. Gas!
Exhaust Corporation



A7700163

A7700166

Dr. Gas SpinPro 5-Trap Low Profile Muffler

Only 3" thick! These mufflers produce an extremely smooth deep tone at a moderate volume level. In flow bench tests, these mufflers have shown the same performance as straight pipe of the same inlet/outlet diameter. They are available in high temperature black and copper colored finishes. Made in USA.

2.5" Offset Inlet/Offset Outlet

A7700163	black	18" x 7.5" x 3"	119.99 ea
A7700164	copper	18" x 7.5" x 3"	124.99 ea

A7700165	black	18" x 7.5" x 3"	129.99 ea
A7700166	copper	18" x 7.5" x 3"	134.99 ea

New!

Dr. Gas!
Exhaust Corporation



A7700171

Dr. Gas SpinPro 3-Trap Muffler

These amazingly compact mufflers are very effective against rasp and popping while delivering a very smooth, deep tone. Flow rates are comparable to straight-through mufflers. Their extremely rugged construction utilizes fully welded 14 and 16 gauge aluminumized steel with high-heat coatings. Available in black or a copper that looks great on rear-mount applications where mufflers are visible. Made in USA.

2" Offset Inlet/Offset Outlet

A7700167	black	12" x 6.5" x 3.25"	99.99 ea
A7700168	copper	12" x 6.5" x 3.25"	103.99 ea

2.5" Offset Inlet 2" Offset Outlet

A7700169	black	12" x 6.5" x 3.25"	99.99 ea
A7700170	copper	12" x 6.5" x 3.25"	103.99 ea

2.5" Offset Inlet/Offset Outlet

A7700171	black	12" x 6.5" x 3.25"	99.99 ea
A7700172	copper	12" x 6.5" x 3.25"	103.99 ea
A7700173	black	12" x 6.5" x 4.25"	109.99 ea
A7700174	copper	12" x 6.5" x 4.25"	113.99 ea

3" Offset Inlet 2.5" Offset Outlet

A7700175	black	12" x 6.5" x 4.25"	109.99 ea
A7700176	copper	12" x 6.5" x 4.25"	113.99 ea

3" Offset Inlet/Offset Outlet

A7700177	black	12" x 6.5" x 4.25"	109.99 ea
A7700178	copper	12" x 6.5" x 4.25"	113.99 ea
A7700179	black	12" x 6.5" x 4.25"	109.99 ea
A7700180	copper	12" x 6.5" x 4.25"	113.99 ea

3.5" Offset Inlet/Offset Outlet

A7700181	black	12" x 6.5" x 4.25"	109.99 ea
A7700182	copper	12" x 6.5" x 4.25"	113.99 ea

New!

Dr. Gas!
Exhaust Corporation



A7700125

Dr. Gas Boom Tube Tips

These Boom Tube Tips are similar to full-size Boom Tube, but are shorter in length for easy installation. They still have the same 8" by 1.75" compact size after the inlet transition. Tips are pre-cut at 45° to expose an 1 1/4" opening at the side of the car and can be trimmed to match the profile of your car. Tips are fully MIG welded and are available individually or in pairs. Boom Tube tips are approximately 23" long on the long side and 14" long on the short side and are trimmed with 2.5", 3", or 3.5" round inlet pipes. Made in USA.

Note: Arrived or modified tips cannot be returned.

Single Boom Tube Tips

A7700125	2.5" inlet	RH exit	139.99 ea
A7700126	2.5" inlet	LH exit	139.99 ea
A7700127	3" inlet	RH exit	139.99 ea
A7700128	3" inlet	LH exit	139.99 ea
A7700129	3.5" inlet	RH exit	139.99 ea
A7700130	3.5" inlet	LH exit	139.99 ea

Boom Tube Tip Pairs

A7700131	2.5" inlet	RH & LH	224.99 pr
A7700132	3" inlet	RH & LH	224.99 pr
A7700133	3.5" inlet	RH & LH	224.99 pr

Performance Exhausts

New!

Dr. Gas!
Exhaust Corporation



A7700110



Dr. Gas Boom Tubes

Dr. Gas Boom Tubes were designed for stock car racing, and now these low-profile side-exit exhausts are available for your muscle car. Boom Tubes have no restriction and are a perfect add-on for exhaust cut-outs. Boom Tubes are fully MIG welded and can be trimmed to match your vehicle's side profile. Untrimmed Boom Tubes measure approximately 27.5" long and are available with 2.5", 3", and 3.5" round inlets. From the inlet transition, they drop to a thin 1.75" thick and 8" wide with two lightweight support ribs. Exposed exit is approximately 12" to 14" depending on the trim angle. Combine with Dr. Gas mufflers and x-pipe system for a one-of-a-kind exhaust sound! Made in USA.

Note: Test fit before trimming. No returns accepted once Boom Tubes are trimmed or altered.

Single Boom Tubes	
A7700110	2.5" inlet..... 209.99 ea
A7700111	3" inlet..... 209.99 ea
A7700112	3.5" inlet..... 209.99 ea
Boom Tube Pairs	
A7700113	2.5" inlet..... 399.99 pr
A7700114	3" inlet..... 399.99 pr
A7700115	3.5" inlet..... 399.99 pr

New!

Dr. Gas!
Exhaust Corporation



A7700116



Dr. Gas Boom Tube Mufflers

Dr. Gas Boom Tube Mufflers offer the same fit as a Boom Tube, but have built-in mufflers! Perfect for low ground clearance applications while giving that great side-exit look. Boom Tube mufflers are fully MIG welded and can be trimmed to match your vehicle's side profile. Untrimmed Boom Tube Mufflers are approximately 30" long and are available with 2.5", 3", or 3.5" round inlet tubes for both right and left side exit. Made in USA.

Note: Test fit before trimming. No returns accepted once Boom Tubes are trimmed or altered.

Single Boom Tube Mufflers	
A7700116	2.5" inlet RH exit..... 289.99 ea
A7700117	2.5" inlet LH exit..... 289.99 ea
A7700118	3" inlet RH exit..... 289.99 ea
A7700119	3" inlet LH exit..... 289.99 ea
A7700120	3.5" inlet RH exit..... 289.99 ea
A7700121	3.5" inlet LH exit..... 289.99 ea
Boom Tube Muffler Pairs	
A7700122	2.5" inlet RH & LH..... 529.99 pr
A7700123	3" inlet RH & LH..... 529.99 pr
A7700124	3.5" inlet RH & LH..... 529.99 pr

New!

Dr. Gas!
Exhaust Corporation



A7700139



Dr. Gas Universal X-Pipe Crossover

Dr. Gas designed and commercialized the x-pipe crossover in the '80s. X-pipes equalize exhaust system pressure imbalances while producing a scavenging effect for more power and efficiency. Exhaust note is dramatically improved to a smoother, higher-pitch note. Universal x-pipe crossover sets are available in 2.5", 3", 3.5", and two special sizes with built-in reducers after the X junction. Sizes with reducers deliver enhanced torque without a horsepower loss. Complete sets include two inlet bends, the x-pipe junction, two outlet bends, and flanges with gaskets and hardware. Precision made with premium materials. Made in USA.

Note: Welding and trimming required. Test fit before final installation. No returns accepted once products are trimmed or altered.

Complete X-Pipe Crossover Sets	
A7700139	2.5" inlet 2.5" outlet..... 249.99 set
A7700140	3" inlet 3" outlet..... 274.99 set
A7700141	3" inlet 2.5" outlet..... 289.99 set
A7700142	3.5" inlet 3.5" outlet..... 299.99 set
A7700143	3.5" inlet 3" outlet..... 339.99 set
X-Pipe Crossover Only	
A7700134	2.5" inlet 2.5" outlet..... 119.99 ea
A7700135	3" inlet 3" outlet..... 139.99 ea
A7700136	3" inlet 2.5" outlet..... 169.99 ea
A7700137	3.5" inlet 3.5" outlet..... 154.99 ea
A7700138	3.5" inlet 3" outlet..... 179.99 ea



115852

1970-72 E-Body Magnaflow Exhaust

These crossmember-back systems include stainless exhaust pipes with x-pipe, clamps, 4" x 9" x 14" mufflers, hangers, dual exhaust with a dual split rear exit. Made from 100% stainless steel, easy to install, mandrel-bent. All welded. Built to Last. For 318/340/360/383/426/640.

Note: Shipped double oversize.

115851	1970-72 2.5"..... 614.99 set
115852	1970-72 3"..... 809.99 set



MA2490



MA2491

PYPES

Stainless Performance Exhaust Systems

Pypes exhaust systems deliver enhanced performance, provide extra punch in the passing lane, and improve gas mileage. Fabricated using the highest quality materials, 16 gauge, mandrel-bent, stainless steel pipe ensures maximum exhaust gas flow, which can significantly boost horsepower. The stainless pipe and muffler construction resists corrosion and extends the life of their system. Pypes mufflers, x-pipes, and OEM-style stainless tailpipes, are precision matched to deliver the ultimate in sound as well as performance. Cadmium-plated or stainless hardware and hangers are included. These systems can be installed without any special tools. Some cutting may be required. 2-1/2" crossmember back system.

Note: Shipped double oversize.

A-Body	
With Street Pro Mufflers	
MA2490 1967-73	429.99 set
With Race Pro Mufflers	
MA2491 1967-73	439.99 set
With Violator Mufflers	
MA2492 1967-73	439.99 set

B-Body	
With Street Pro Mufflers	
MB1690 1966-74	469.99 set

E-Body	
With Street Pro Mufflers	
ME2803 1970-74 valve exit	429.99 set

New!



BORLA

1971 Barracuda Borla Dual Exhaust

Features a 2-1/2" mandrel-bent tubing with H-pipe and low-restriction single-flow mufflers, these manifold-back systems omit head pipes to make them ideal for use with headers. This split rear exit system includes angle cut double-rolled rectangular exhaust tips. Manufactured from high quality stainless steel and backed by a 1,000,000 mile warranty.

Note: Shipped double oversize.

BA100407	1971 383 ci exhaust system..... 981.99 set
----------	--

OEM Exhaust Tips



MB2648

1971-74 B-Body Slotted Exhaust Tips

These authentic Mopar exhaust tips for 1971-74 B-Body models feature correct slots, painted insert and are polished to a mirror-like finish. Available in the short (approx. 12") or long style (approx. 14"). Sold in pairs.

Long Style w/Red Insert
MB1686 1971-72 2-1/4" stainless..... 264.99 pr
MB2648 1971-72 2-1/2" stainless..... 149.99 pr
MB1493 1971-72 3" stainless..... 298.99 pr

Long Style w/Black Insert
MB1494 1971-72 2-1/2" stainless..... 264.99 pr
MB1495 1971-72 3" stainless..... 264.99 pr

Short Style w/Red Insert
MB2649 1971-74 2-1/2" stainless..... 265.99 pr
MB1497 1971-74 3" stainless..... 264.99 pr



MB2650

1971-74 B-Body Resonator Exhaust Tips

These authentic Mopar slotted exhaust tips feature correct painted inserts and are polished to a mirror-like finish. For 1971-74 B-Body models with resonators. Sold in pairs.

Short Style
MB2650 1971-72 Plymouth-red..... 104.99 pr
MB1498 1971-72 Plymouth-black..... 104.99 pr

Long Style
MB1499 1971-74 Dodge-red..... 249.99 pr
MB1499 1971-74 Plymouth-red..... 249.99 pr



1965-67 A-Body Resonator & Tip Assembly

Replacement resonator and tip assembly for 1965-67 Dart and Barracuda models with the 273 high performance option. Features a fully aluminum resonator, with a mirror like finish stainless tip that is made to look and perform well for many years.
MA2443 1965-67 resonator & tip..... 299.99 ea



1968-74 A-Body Stainless Tips

Stainless exhaust tips for various 1968-74 A-Body models. Feature the correct finish and mounting hanger. Will fit 1968-69 Dart/Valiant, 1970-74 Duster, 1971-72 Demon and 1973-74 Dart Sport.
MA2388 1968-74 2-1/4" i.d. stainless..... 134.99 pr
MA2389 1968-74 2-1/2" i.d. stainless..... 134.99 pr
MA2390 1968-74 3" i.d. stainless..... 119.99 pr



MA2391

1968-74 A-Body Exhaust Tips

Reproduction exhaust tips for various A-Body models. Features the correct contours and mounting hangers. Available in chrome and polished stainless.

1968-69 Barracuda, 1970 Dart Swinger
MA2391 1968-70 1-7/8" o.d.-chrome..... 119.99 pr
MA2392 1968-70 2-1/4" i.d.-stainless..... 159.99 pr
MA2393 1968-70 2-1/2" i.d.-stainless..... 134.99 pr
MA2394 1968-70 3" i.d.-stainless..... 119.99 pr

1968-69 Dart/Valiant
MA2446 1968-74 2" o.d.-chrome..... 159.99 pr
MA2388 1968-74 2-1/4" i.d.-stainless..... 134.99 pr
MA2389 1968-74 2-1/2" i.d.-stainless..... 134.99 pr
MA2390 1968-74 3" i.d.-stainless..... 119.99 pr

1970-74 Duster/Demon/Dart Sport
MA2446 1968-74 2-1/4" o.d.-chrome..... 159.99 pr
MA2388 1968-74 2-1/4" i.d.-stainless..... 134.99 pr
MA2389 1968-74 2-1/2" i.d.-stainless..... 134.99 pr
MA2390 1968-74 3" i.d.-stainless..... 119.99 pr



MN1513



1967 GTX Exhaust Tips

These B-Body exhaust tips for 1967 GTX models feature the correct contours, and mounting hanger. Available in stainless steel and chrome. Made in USA.
MN2364 1967 chrome..... 159.99 pr
MB15113 1967 stainless..... 154.99 pr



MB2642

1968-70 B-Body Exhaust Tips

Replacement exhaust tips for various B-Body models. Choose from highly polished chrome or a big-bore 304 stainless design. Chrome tips feature the proper drain hole and install inside of the tailpipe as original.

Charger
MB15114 1968-70 2-1/4" o.d.-chrome..... 159.99 pr
MB2639 1968-70 2-1/4" i.d.-stainless..... 134.99 pr
MB2640 1968-70 2-1/2" i.d.-stainless..... 134.99 pr
MB2641 1968-70 3" i.d.-stainless..... 119.99 pr

GTX/Road Runner
MB15115 1968-70 2-1/4" o.d.-chrome..... 159.99 pr
MB2642 1968-70 2-1/4" i.d.-stainless..... 159.99 pr
MB2643 1968-70 2-1/2" i.d.-stainless..... 159.99 pr
MB2644 1968-70 3" i.d.-stainless..... 159.99 pr

Super Bee/Coronet RT
MB15116 1968-70 2-1/4" o.d.-chrome..... 159.99 pr
MB2645 1968-70 2-1/4" i.d.-stainless..... 134.99 pr
MB2646 1968-70 2-1/2" i.d.-stainless..... 134.99 pr
MB2647 1968-70 3" i.d.-stainless..... 119.99 pr

New!

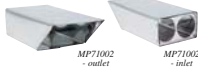

MP71002

- outlet

MP71002

- inlet

1964-66 Commando Exhaust Tips

Polished stainless steel exhaust tips for 1964-66 A-body cars equipped with a Commando-style exhaust system. These custom exhaust tips are designed to be an alternative to replacing the original resonator and tip assembly. Can be used with your choice of resonator or glasspack style muffler.

MP71001 1964-66 single 2" inlet..... 79.99 ea
MP71002 1964-66 dual 2" inlets..... 79.99 ea
MP71003 1964-66 open..... 79.99 ea



ME1008

ME138

1970-74 E-Body Stainless Exhaust Tips

These reproduction exhaust tips for 1970-74 E-Body models are manufactured in stainless steel and polished to a bright finish. For all Barracuda and Challenger models with the optional exhaust tips. Sold in pairs.

Barracuda
ME1008 1970-74 2" o.d. 159.99 pr
ME1317 1970-74 2-1/2" i.d. 149.99 pr

Challenger
ME1009 1970-74 2" o.d. 179.99 pr
ME1318 1970-74 2-1/2" i.d. 169.99 pr



ME1753

1970-74 E-Body Performance Exhaust Tips

Performance stainless steel exhaust tips for 1970-74 E-Body models. These exhaust tips offer straight-through performance and a mirror-like shine.

Barracuda
ME1753 1970-74 2-1/2" i.d. 179.99 pr
ME1754 1970-74 3" i.d. 189.99 pr

Challenger
ME1714 1970-74 2-1/2" i.d. 189.99 pr
ME1715 1970-74 3" i.d. 199.99 pr



1970 AAR & T/A Stainless Quarter Tips

Exhaust tips for 1970 AAR Cuda and Challenger T/A models. These tips feature correct finish, include the bracket hanger and extension pipe to muffler. These exhaust tips mount to each side of the vehicle in front of the rear wheel.
ME1716 1970 2" i.d. 269.99 pr

Exhaust Components



1970 AAR/TA Muffler Hangers

Muffler hangers for 1970 AAR 'Cuda and T/A Challenger models. This hanger bolts up to the floor board in order to support the muffler straps.

ME5039 1970 muffler hangers..... 42.99 pr



1970-74 E-Body Muffler Hangers

Muffler hangers for 1970-74 Barracuda and Challenger models. These hangers secure the rear side of the muffler to the trunk floor. For models with or without exhaust tips.

ME5040 1970-74 muffler hangers... 49.99 pr



1968-70 B-Body Muffler Hangers

Muffler hangers for all 1968-70 B-Body models. This hanger bolts to the floor pan mounting bracket and also supports and clamps the tail pipe to the muffler.

MB2637 1968-70 2-1/4"..... 49.99 pr



1968-70 A-Body Muffler to Floor Pan Mounting Bracket

This steel muffler floor pan support bracket mounts to the floor pan and provides a place to attach the muffler hanger. Use for left or right.

MN2361 1968-70 A-Body..... 39.99 ea



MN2362

MN2363

1966-74 B & E-Body Resonator Floor Pan Mounting Bracket

This resonator floor pan support bracket is made from steel and mounts to the floor pan to provide a place to attach the resonator hanger. Hardware is included.

MN2362 1966-70 B-Body..... 39.99 ea
MN2363 1970-74 E-Body..... 39.99 ea



1970-74 E-Body Tail Pipe Hangers

This tail pipe support hanger bolts to the floor pan brackets that are mounted above the resonators. For all 1970 Barracuda and Challenger models.

ME5042 1970-74 2-1/4"..... 49.99 pr



1967-69 Hemi & 440 Tailpipe Hangers

Replacement tail pipe hanger for 1967-69 Hemi & 440 B-Body models. This hanger bolts to the floor pan and at the same time supports and clamps the tailpipe to the muffler.

MB2636 1967-69 2-1/4"..... 54.99 pr



1971-74 B & E-Body Tailpipe Hanger

This is the right side hanger mounted up by the shock absorber on most B and E-Body models. For 1971-74 B-Body and 1971-73 E-Body models.

MD4527 1971-74 RH..... 44.99 ea



1967 GTX Exhaust Tip Hangers

This hanger bolts to the rear end of the rear frame rail.

For 1967 GTX models with dual exhaust.
MB2632 1967 exhaust tip hangers... 41.99 pr



1968-74 A-Body Exhaust Tip Hanger

This hanger bolts to the rear end of the rear frame rail.

For all 1968-74 A-Body models with dual exhaust.
MA2483 1968-74 exhaust tip hangers... 39.99 pr



MB2634

1968-74 B-Body Exhaust Tip Hangers

This hanger bolts to the rear end of the rear frame rail.

For all 1968-74 B-Body models with dual exhaust.

MB2633 1968-70 Charger..... 42.99 pr
MB2634 1968-70 except Charger.... 42.99 pr
MB2635 1971-74 all B-Body..... 44.99 pr



1970 AAR/TA Exhaust Tip Hangers

Exhaust tip hangers for 1970 AAR 'Cuda and Challenger T/A models. Manufactured from stamped steel these pieces bolt to the frame rails and include rubber insulators.

ME5041 1970 exhaust tip hangers.... 41.99 pr



1972-74 E-Body Exhaust Tip Hanger Bracket

Reproduction exhaust tip hanger bracket for 1972-74 E-Body models. This bracket bolts to the rear frame rail and supports the exhaust hanger. Each bracket features correct bolt hole locations, comes EDP coated, and is designed to replace the original exactly.

ME5053 1972-74 E-Body..... 24.99 ea

B&M Transmission Products

Pour-in Performance!

Trick Shift™ was originally developed by B&M for racing applications. It's become so successful that it's the most popular high performance fluid on the street also! Not an additive, this is the best performance ATF available! A scientific blend of foam inhibitors, pressure agents and shift modifiers that will provide extended transmission life and drastically improved shift feel. Trick Shift™ is the easiest way to measurably improve the transmission performance of your vehicle. Trick Shift™ works with all automatic transmissions when a firmer shift is desired. "Four in Performance" isn't just a catchy phrase - it's reality! It can be mixed with stock-type transmission fluids, however to attain maximum improvement you should use Trick Shift™ exclusively. Ideal for towing, light trucks and RV applications as well as racing.

Important: Not recommended for electronically controlled automatic transmissions.
Note: No further discounts apply.
223040 Original Trick Shift™ - 1 qt..... 5.99 ea
Buy a Case & Save 11.45!
223041 Original Trick Shift™ - 12 qts... 75.99 ea



Formulated For Late Models!

B&M's Synthetic Trick Shift™ is suitable for all automatic transmissions including late model electronic controlled transmissions. Formulated as a performance automatic transmission fluid, it features the latest synthetic fluid technology. Not an additive, this safe and effective formula of extreme pressure agents and foam inhibitors provides a long service life for your transmission. Ideal for street use and high performance applications including racing, off-road, towing and heavy duty fleet use. Synthetic Trick Shift™ may be mixed with all other types of ATF but works best by itself.
Note: No further discounts apply.

Key Features:

- Cool blue color
- Latest synthetic fluid technology
- Excellent when installing all B&M transmission kits
- Mixes with other types of automatic transmission fluids
- Formulated for late model vehicles
- Suitable for racing, street performance, towing and off-road applications
- Easy pour quart bottles
- Meets or exceeds Mercon or Dexron III requirements.

223042 Synthetic Trick Shift™ - 1 qt.... 9.99 ea
Buy a Case & Save 15.45!
223043 Synthetic Trick Shift™ - 12 qts 113.99 ea



Fifty Years of Expertise!

B&M has been building extreme duty transmissions for 5 decades. From the famous B&M Hydrostick of the 50's to the Torquemasters and Clutchflites of the 60's, B&M transmissions are unequalled in quality, features, or durability and is the standard to which all performance automatics have been measured.

Note: All transmissions are special order and must be pre-paid. No further discounts apply.

Street/Strip TF-727

B&M's Street/Strip Transmission is a complete ready to run unit (less converter) designed to offer exceptional performance on the street and stand up to mild drag strip use. Provides firm shifts and features a standard shift pattern.

Torqueflite 727

Key Features:

- 2.45 first gear ratio, 1:45 second gear.
- Rebuilt front pump
- Five clutch direct drum
- New low roller clutch
- B&M 5.0 servo lever
- Four pinion front carrier
- All new B&M high performance friction plates
- Performance Frictions
- New special bellville spring
- Fully re-calibrated valve body

Important: Transmissions shipped truck freight.

Note: No further discounts apply.

MN2369 Street/Strip, 273-360.....

MN2370 Street/Strip, 361-440.....

1289.99 ea

1914.99 ea



HoleShot For Small Block & Big Block Applications!

The HoleShot converter delivers a higher stall speed, providing several advantages and benefits in vehicles with modified engines. Big cams in particular tend to reduce low end power and torque. A high stall converter allows the engine to launch the car at higher rpm where more torque is available. The HoleShot is designed for street and mild strip use, offering better, stronger launches. Street rods with modified engines will also benefit from a HoleShot converter. Not recommended for use on engines equipped with nitrous oxide. Stall speed listings are based on engines producing 230lb. ft. of torque at 2,500 rpm. More torque at 2,500 rpm will give you a higher stall speed, less torque at 2,500 rpm will give you a lower stall speed than the stall speed ratings indicated.

Note: No further discounts apply.

HoleShot 2400

2300-2500 RPM Stall Speed

MN3011 TorqueFlite A-727.....



HoleShot 3000

2800-3200 RPM Stall Speed

MN3012 TorqueFlite A-727.....

344.99 ea

574.99 ea



Tork Master For Mild Performance Small Blocks!

Similar to the HoleShot series, the Tork Master is B&M's is an excellent all-around performance street converter for small block Mopar. One of the best "value priced" street converters available, the Tork Master converter features a new precision pump drive tube, is fully balanced and pressure tested for reliability. It also features a new thrust washer between the turbine and cover when required and need thrust bearings when factory equipped. The Tork Master tork converter is not recommended for big block or supercharged applications.

Note: No further discounts apply.

Tork Master™ 2400

2300-2500 RPM Stall Speed

MN3013 TorqueFlite A-727.....



254.99 ea



B&M Transmission Products



M23265

Provide Crisp Shifts And Eliminate Slippage Without Removing Your Transmission!

The B&M Shift Improver Kit is the easiest way to get stout performance out of your automatic transmission. Choose from the Heavy Duty Stage 1 kit, and the Street/Strip Stage 3. All you need are a few hand tools! In the space of an afternoon, you can turn your transmission into a B&M-tuned unit!

Stage 1-Heavy Duty

Firm, positive shifts without loss of driver comfort for improved performance in all street vehicles. Recommended for regular passenger vehicles.

Stage 2-Street/Strip

Provides very positive shifts for high performance street use or for competitive events. This model is for the enthusiast who wants the hardest, quickest possible shift.

Key Features:

- Provides crisp shifts on any stock automatic transmissions.
- Elimination of soft sluggish shifts, shift overlap, and excess wear on clutches and bands due to slippage.
- Improves transmission life.
- Transmission removal not required.

Note: No further discounts apply.

M23265	1966-70	A-727.....	41.99 set
M23265	1966-76	A-904 w/6 cylinder, 41.99 set	
M23265	1968-70	A-904 w/V8.....	41.99 set
M23266	1971-76	A-727.....	41.99 set
M23266	1971-76	A-904 w/V8.....	41.99 set



M23204

Recalibrate Your Transmission for Optimum Performance

The Transpak has all the features of the Shift Improver Kit, plus additional driver control (Chrysler Torqueflite only). Most stock automatic transmissions won't downshift into low gear above 15 mph, and upshift at a set speed no matter what gear you're in. With the Transpak, you can downshift at any speed and hold the transmission in first gear to any speed! Two sets in one allow you to choose your level of performance. Includes B&M performance friction materials, complete overhaul gasket set, B&M Transpak valves, springs, and components drain plug.

Stage 1 Heavy Duty

For street rods, normal passenger vehicles and heavy duty use. Firmer shift feel but not harsh. Improves transmission performance and life dramatically without loss of comfort. Normal automatic operation when in "Drive."

Stage 2 Hi-Performance Street

For performance street use. Essentially the same as Heavy Duty mode except shift is much quicker. Retains full automatic features and standard shift points with selector in "Drive."

Note: No further discounts apply.

M23267	1966-76	A-727, A-904.....	99.99 set
--------	---------	-------------------	-----------

B&M Transmission

In A Box!

This is the most comprehensive kit available, with parts or necessary part numbers to upgrade your Chrysler Torqueflite A-727 into a true performance transmission. Comes with instruction sheets that provide the do-it-yourselfer with all the information needed to completely overhaul a A-727 to B&M specs. Easy to understand even if you have no experience in this area!

Note: No further discounts apply.

Key Features:

- B&M Street/Strip Transmission components in a do-it-yourself kit.
- Transpak modification components including special replacement valves and springs.
- Includes all necessary parts, springs, plates, etc., to convert your valve body to a full B&M Manual Automatic valve body.
- Improved shift feel, retains full automatic features.
- B&M high performance friction materials
- Complete overhaul gasket set & Drain plug

M23268	1970-76	A-727.....	339.99 set
--------	---------	------------	------------



223204

B&M Replacement Adapters & Filter

B&M extra capacity deep pans come with an adapter to make sure the filter is located at the proper depth in the transmission pan.

Note: No further discounts apply.

Replacement Adapters

MN3022	A-727.....	49.99 ea
--------	------------	----------

Replacement Filter for B&M Pans

223204	A-727.....	15.99 ea
--------	------------	----------



B&M Cast Aluminum Transmission Pan

This B&M cast aluminum deep pan adds an additional 4 quarts of fluid capacity. Lower temperatures along with proper maintenance will extend the life of your automatic transmission. Features built-in drain plugs, includes filter adapter, requires no modification to the dipstick. Fits Chrysler Torqueflite A-727 & 518.

Note: No further discounts apply.

MN3010	A-727 & 518.....	169.99 ea
--------	------------------	-----------

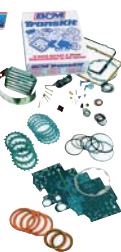

Made in USA

AR1447

Mopar Torque Converter Bolt Sets

You can forget about shearing a torque converter bolts after you install these fasteners rated at 200,000 PSI. Each set is specifically designed for each application to provide optimum grip. Kits include hardened parallel-ground washers. Made in USA.

TorqueFlite 727 & 904

AR1447	w/stock converter.....	7.99 set
--------	------------------------	----------

AR1448	w/aftermarket converter.....	11.99 set
--------	------------------------------	-----------

NAG1 5-Speed Automatic

AR1449	w/stock converter.....	19.99 set
--------	------------------------	-----------



Made in USA

AR1444

Flexplate Bolt Sets

You can forget about shearing a flexplate bolts after you install these fasteners rated at 200,000 PSI. Each set is specifically designed for each application to provide optimum grip. Kits include hardened parallel-ground washers. Made in USA.

Slant Six, Small Block & Big Block

AR1444	6 bolt crank.....	14.99 set
--------	-------------------	-----------

AR1445	8 bolt crank.....	34.99 set
--------	-------------------	-----------

5.7L, 6.1L & 6.4L Hemi

AR1446	44.99 set
--------	-------	-----------

B&M Flexplates for Mopar Transmissions

These SFI-approved B&M flexplates are manufactured to precise tolerances to ensure the flexplate center will not explode at high RPM. Dual bolt patterns accommodate a variety of transmission applications.

Note: *Big blocks with cast crank are externally balanced.

No further discounts apply.

Key Features:

- SFI spec 29.1 approved
- NHRA/IHRA legal
- SFI spec 29.1 certification
- sticker included
- Ideal for street applications to extreme duty racing and high RPM use, above 6,000 RPM
- Dual bolt pattern (10" & 11-1/8") on A-727 flexplates.

TorqueFlite A-727

Small Block			
-------------	--	--	--

MN3015	1962-92	273-318, 6-bolt crank.....	101.99 ea
--------	---------	----------------------------	-----------

MN3016	1962-92	273-318, 8-bolt crank.....	101.99 ea
--------	---------	----------------------------	-----------

MN3021	1971-76	340.....	99.99 ea
--------	---------	----------	----------

MN3019	1971-92	360.....	101.99 ea
--------	---------	----------	-----------

Big Block*

MN3015	1962-78	internally, 6-bolt crank.....	101.99 ea
--------	---------	-------------------------------	-----------

MN3016	1962-78	internally, 8-bolt crank.....	101.99 ea
--------	---------	-------------------------------	-----------

MN3017	1971-78	externally balanced.....	101.99 ea
--------	---------	--------------------------	-----------

TorqueFlite A-904

MN3016	1962-92	273-318, 8-bolt crank.....	101.99 ea
--------	---------	----------------------------	-----------

MN3018	1971-92	360.....	101.99 ea
--------	---------	----------	-----------



Performance Transmissions



MN2509

- 1 year warranty from day of use
- New clutches, steels, seals & gaskets
- Updated boost valve system
- New overdrive & lower roller sprag
- Updated servo piston
- Hardened forward clutch hub
- 300M billet input shaft
- Updated shift valve springs
- Wide kickdown band
- Electronic speed sensor
- New valve body separator plate
- Better lubrication system
- All new Torrington bearings
- All new thrust washers
- New fill tube and indicator
- Energy suspension trans mount
- Custom billet stall converter
- Bowler dependability & durability

Bowler Custom 4L80E High Performance 4 Speed AT for Mopar

If your Mopar produces 650 to 1000 ft lbs of torque, you need a Bowler custom 4L80E performance transmission. Bowler transmissions are built to order, tailored to your specifications, and unlike assembly-built transmissions, every Bowler unit is built by an individual technician start-to-finish and dyno tested before shipping. Includes bellhousing, flexplate, converter, computer and accessories. Does not come with driveshaft or crossmember. Modifications may be needed for fitment. Please allow 4 to 6 weeks for your custom transmission to be built.

Note: Special order, must be pre-paid. Shipped truck freight. No further discounts apply.

MN2509	1960-76	4L80E rated at 650 ft lbs torque	7699.99 ea
MN2510	1960-76	4L80E rated at 800 ft lbs torque	8419.99 ea
MN2511	1960-76	4L80E rated at 1000 ft lbs torque	9115.99 ea

New!



MP800115

A&A Restoration Transmissions

A&A has long been recognized for its quality transmission rebuilds. They offer basic rebuild restoration style transmissions. Features: Blasted and prepped case, bolt-in sprag, 3- or 4-pinion aluminum planetaries that use stock thrust washers, stock ratio is 2.45/1.45/1.1, reconditioned front pump and support, A&A modified valve body.

Note: No further discounts apply.

727 Transmission			
MP800115	1966-76	small block	1885.99 ea
MP800113	1966-76	big block	1885.99 ea
904 Transmission			
MP800116	1966-76	small block	1625.99 ea

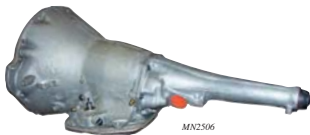

MN2506

- 1 year warranty from day of use
- New clutches, steels, seals & gaskets
- Updated boost valve system
- Updated lower roller sprag
- Heavy Duty reverse band
- Blue printed pump
- Updated shift valve springs
- New bushings
- New valve body separator plate
- All new Torrington bearings
- All new thrust washers
- Shallow steel pan
- New fill tube and indicator
- New transmission mount
- Custom billet stall converter
- Bowler dependability & durability

Bowler Custom Torque-Flite 727 High Performance Transmissions

Get the right transmission the first time! Bowler Transmissions are built to order, customized to your vehicle specifications. Unlike assembly-built transmissions, every bowler transmission is built by a qualified individual technician, then dyno tested before being packaged and shipped. Bowler has been building transmissions since 1963 and knows what it takes to meet the demands of your vehicle. Allow 4 to 6 weeks for your custom transmission to be built.

Note: Skipped truck freight. No further discounts apply.

MN2506	1960-76	TF-727 rated at 375 ft lbs torque	2599.99 ea
MN2507	1960-76	TF-727 rated at 450 ft lbs torque	3399.99 ea
MN2508	1960-76	TF-727 rated at 650 ft lbs torque	4199.99 ea

Performance Automatic Racing Street Smart Transmissions



MN2372

- 11" 2400-2800 stall torque converter
- Dipstick with tube
- Transmission mount
- Alto racing clutches
- High performance bands
- Transgo shift kit
- Heavy duty intermediate sprag/race

Chrysler A-904 and A-727 transmissions have been the backbone of Chrysler for over 40 years. These Performance Automatic Racing Street Smart transmissions units get a deep sump pan, a thorough rework, and complete dyno testing to handle high levels of horsepower. Backed by a lifetime warranty.

Note: Skipped truck freight. No further discounts apply.

MN2371	A-904	400 hp, with steel pan	1914.99 ea
MN2372	A-727	600 hp, small block, with aluminum pan	2104.99 ea
MN2373	A-727	600 hp, big block, with aluminum pan	2319.99 ea

Performance Transmissions

Optimal for Engines Making Up To 450hp!



MN2408



MN2410



TCI Automatic Transmissions

The TCI StreetFighter transmission is strong enough to withstand the rigors of even the toughest street machines. It is ideal for use with non-supercharged engines producing 450 horsepower using pump gasoline. Each TCI transmission is triple tested.

Note: Skipped track freight. No further discounts apply.

Small Block

MN2408	A-727	318, 340 & 360, with 18-3/8" tailshaft	1299.99 ea
MN2409	A-904	318, 340 & 360	1299.99 ea

Big Block

MN2410	A-727	383, 400, 426 and 440, with 18-3/8" tailshaft	1299.99 ea
--------	-------	---	------------



Royal Purple Max ATF

Max ATF is a synthetic, high-performance, automatic transmission fluid. Its low co-efficient of friction and high film strength help to dramatically reduce heat and wear. Additionally, Max ATF is more oxidation stable than other transmission fluids for longer fluid life. Max ATF is recommended for a wide variety of transmissions. Max ATF significantly reduces heat to extend the life of your transmission. Automatic transmissions generate a great deal of heat and depend upon the transmission fluid for cooling and protection. Max ATF is fully compatible and can be mixed with other automatic transmission fluids; however, for the best results drain or flush the current oil and then fill with Max ATF.



RP11320	quart	15.99 ea
RP12320	case of 12 quarts	172.99 ea

No More Messy Oil Splash!

Only a few automatic transmissions are equipped with drain plugs from the factory, but you can install one yourself very easily. Simply remove the pan once, drill a hole, bolt the B&M drain plug kit in, and eliminate messy oil splash forever. Non magnetic. Universal fit.



Note: No further discounts apply.

223300	drain plug	9.99 ea
--------	------------	---------



MN2404

Gear Vendors Under/Overdrive

Give your Mopar vehicle up to twice the forward gear ratios with the Under/Overdrive auxiliary transmission from Gear Vendors. This supplemental planetary gearbox adapts to the output shaft of your existing transmission to provide an extra gear of 0.78:1. The initial benefit is the addition of a 22% overdrive in high gear, but because it can be engaged in any gear, it doubles the number of ratios available in any transmission. Increase fuel economy and use your engine's power more efficiently!

Note: Special order, must be shipped. Skipped track freight. No further discounts apply.

A 833 Manual transmission			
MN2404	with 18" tailhousing		2894.99 ea
A 904 Automatic transmission			
MN2405	with 15" tailhousing		2794.99 ea
A 727 Automatic transmission			
MN2406	with 8" tailhousing		2794.99 ea
MN2407	with 18" tailhousing		2794.99 ea



Reduce the Chance of Rolling the Lights & Produce More Effective Burn Outs with the original Hurst Roll/Control!

Used primarily in drag racing to provide positive locking action to the front wheels of race cars. In tests, the Hurst Roll/Control has proved a 1/100,000 of a second release time and vibration tests have seen up to 30 G's applied without mechanical failure.

1745000	Hurst Roll/Control set	114.99 ea
567150	installation set	44.99 set



Transmission Oiling Parts

New!



MD2550



1962-76 Transmission Dust Shield

Transmission dust shield for small block, big block models equipped with a 727, 904 automatic transmission. This part bolts to the transmission bellhousing to prevent debris from entering the torque converter area. Bolts are black phosphate and sold separately.

Note: Depending on starter some modifications may be necessary.

Transmission Dust Shields

MD2550	1962-76	small block, 727	20.99 ea
MP800117	1962-76	big block, 727	51.99 ea
MP800118	1966-76	small block, 904	45.99 ea

Dust Shield Bolt Sets

MP800120	1962-76	SB, 727/904	17.49 set
MP800119	1962-76	big block, Hemi	22.99 set



1962-76 A-727 Chrome Transmission Pan

Replacement chrome transmission pan for all 727 automatic transmissions. Includes drain plug.

MD2537	1962-76	chrome pan	31.99 ea
--------	---------	------------------	----------



A-727 Cast Aluminum Transmission Pan

These cast aluminum pans for A-727 automatic transmission are 2" deeper than stock and made without the drain plug, as original, to prevent changing the transmission fluid without changing the filter. Available as cast or with a polished finish. Made in the USA.

MN2504	1960-76	as cast	229.99 ea
MN2505	1960-76	polished	285.99 ea



FTM180

Transmission Pan FilterMag

FilterMag's powerful rare-earth magnets trap and hold wear inducing metal particles smaller than 40-microns down to 1-micron that the filter cannot stop. The super-strong magnetic force holds FilterMag to a steel transmission, is reusable, and will reduce maintenance costs by extending the life of your oil. The super-strong automatic transmission FilterMag mounts to the outside bottom of the pan and will keep metal particles from harming your transmission.

FTM180	2.93" x 1.93"	34.99 ea
FTM360	3.18" x 2.93"	59.99 ea

New!



MOPAR

Transmission Oil Cooler/Filter

This automatic transmission oil cooler and filter combination assembly uses a finned aluminum heat sink design to dissipate heat in racing applications. It can also be used as an inline auxiliary cooler in conjunction with the stock cooler. It's compact one pound 3" x 12" aluminum body gives it excellent heat transfer capabilities. An internal filter with magnet traps particles over 5 microns to reduce transmission wear. Includes filter cartridge and two 1/4" NPT to 3/8" line fittings.

241200	99.99 ea
--------	-------	----------



Heavy Duty Transmission Oil Cooler

This high performance transmission oil cooler features an heavy duty 7-1/2" x 20" x 3/4" core for extreme conditions. Comes complete with all hardware, hoses, fittings, adapters and vinstrumtions. Made in USA.

FL4120	universal	54.99 ea
--------	-----------------	----------



MD2549

1962-76 Automatic Dipsticks & Tubes

Replacement transmission dipsticks and tubes for 1966-76 727 and 904 automatic transmissions. Your choice of black powdercoated, locking with zinc finish, or locking with chrome finish. Includes tube, dipstick and o-ring. Made in the USA.

Note: Fits RH side of head.

Black Powdercoated - Non-Locking			
MP800111	1967-69	big block w/727	69.99 set
MP800102	1970-71	big block w/727	69.99 set
MD2549	1966-71	Hemi w/727	59.99 set

Zinc - Locking

MP800103	1962-76	big block w/727	55.99 set
MP800104	1966-76	Hemi w/727	55.99 set
MP800105	1966-76	small block w/727	55.99 set
MP800106	1966-76	small block w/904	55.99 set
Chrome - Locking			
MP800107	1962-76	big block w/727	79.99 set
MP800108	1966-76	Hemi w/727	79.99 set
MP800109	1966-76	small block w/727	79.99 set
MP800110	1966-76	small block w/904	79.99 set

1960-74 Dipstick O-Ring



Original style automatic transmission dipstick components.	MD2553		
MD2553	1960-74	O-ring	2.99 ea



223309



B&M Transmission Super Cooler

B&M SuperCoolers are constructed from 100% aluminum using sandwiched stamped plates. The Super-Coolers intended for automatic transmission fluids and offers an additional feature known as "Low Pressure Drop". A unique bypass feature allows a viscosity-controlled amount of ATF to bypass the cooler when the fluid is cold. Fluid is returned directly to the lube circuit through bypass openings in the core. As the temperature increases, more ATF is directed through the core. This highly efficient design provides improved protection against lube system failure in cold climates. Includes installation kit.

Note: No further discounts apply.

223309	11" x 6" x 1-1/2"	94.99 ea
223310	11" x 7-1/2" x 3/4"	79.99 ea
223311	11" x 5-3/4" x 3/4"	74.99 ea

New!



B&M Hi-Tek Transmission Cooler

The Hi-Tek automatic transmission cooler is perfect for demanding street/strip and even towing applications. At 175", a thermal switch activates the high-flow 12 volt 7" electric fan. Durable, oven brazed aluminum construction promises years of performance. The 1/2" NPT fittings are easily adaptable to AN fittings and steel-braided cooler lines, or can be used with standard rubber or steel lines. Measures 10" x 7-1/2" x 4" and includes electrical connectors and detailed instructions.

Note: No further discounts apply.

70298	291.99 ea
-------	-------	-----------



1966-70 Transmission Cooler Brackets

Replacement transmission cooler mounting bracket set. This set mounts the transmission cooler to the radiator and grill support on 1966-70 vehicles equipped with a Hemi engine and an automatic transmission.

MD2547	1966-70	two piece set	42.99 set
--------	---------	---------------------	-----------



1962-74 Transmission Cooler Line Bracket

This stainless steel bracket mounts to the bellhousing and keeps the transmission cooler lines in place.

MD2546	1962-74	all models	18.99 ea
--------	---------	------------------	----------

Auto Transmission Cooler Lines

Correct replacement transmission cooler lines which run from the transmission to the radiator. Choose between OEM-style galvanized steel lines or long lasting stainless steel which will not rust. Each transmission line is meticulously produced to original specifications for a dur guaranteed perfect fit!

Replace Your Transmission Cooler Lines With OEM Material For Originality Or High Quality, Long Lasting, Stainless Steel!

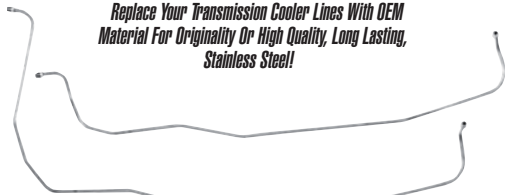

1963-75 A-Body Transmission Cooler Lines

Each line is produced using a precision manufacturing process that creates the correct bends that match factory original equipment. Couple meticulous manufacturing techniques with choice material selection and you can be sure that you are installing the best transmission cooler lines on the market. These lines, produced in

your choice of original material or never-rust stainless steel, will fit your A-Body application and save you the hassle of bending up your own lines. Applications available for a variety of A-Body vehicles including 1964-69 Barracuda, 1963-75 Dart, Valiant and 1970-75 Demon/Dart Sport, Duster and Scamp.

Original Material - A-Body				
MA3449M	1963	904 (3 line set)	44.99	set
MA3450M	1964-68	Slant 6 w/904	39.99	pr
MA3451M	1964-66	w/V8	39.99	pr
MA3452M	1967-69	727 w/loop 12" from radiator	39.99	pr
MA3453M	1969-75	Slant 6 w/904	39.99	pr
MA3454M	1967-72	318 w/904	39.99	pr
MA3455M	1969-71	340 ci w/727	39.99	pr
MA3456M	1969-72	727 w/loop near radiator	39.99	pr
MA3457M	1972-73	340 w/727	39.99	pr
MA3458M	1974	Dart, 318 w/904	39.99	pr
MA3459M	1975	Swinger	44.99	pr

Stainless Steel - A-Body				
MA3449S	1963	904 (3 line set)	74.99	set
MA3450S	1964-68	Slant 6 w/904	69.99	pr
MA3451S	1964-66	w/V8	69.99	pr
MA3452S	1967-69	727 w/loop 12" from radiator	69.99	pr
MA3453S	1969-75	Slant 6 w/904	69.99	pr
MA3454S	1967-72	318 w/904	69.99	pr
MA3455S	1969-71	340 ci w/727	69.99	pr
MA3456S	1969-72	727 w/loop near radiator	69.99	pr
MA3457S	1972-73	340 w/727	69.99	pr
MA3458S	1974	Dart, 318 w/904	69.99	pr
MA3459S	1975	Swinger	74.99	pr

1963-74 B-Body Transmission Cooler Lines

Each line is produced using a special process that duplicates the correct bends that match factory original equipment. Couple precise manufacturing techniques with choice material selection and you can be sure that you are installing the best transmission cooler lines on the market. These lines, produced in your choice of original steel or never-rust stainless steel, will fit your B-Body

and save you the hassle of bending up your own lines. Applications available for 1962-74 B-Body vehicles including 1962 Dodge Dart, Polara 500, 1963 Dodge 330, 440, Polara, Polara 500, 1962-64 Plymouth Savoy, Belvedere, Fury, Sport Fury, 1965 Belvedere, Satellite, 1966-74 Belvedere, Charger, Coronet, GTX, Road Runner, Satellite and Super Bee.

Original Material - B-Body				
MB2609M	1963-65	all vehicles, 2 lines	39.99	set
MB2610M	1966-69	Hemi w/auxiliary cooling (except Charger w/hidden headlights) 4 pcs.	74.99	set
MB2611M	1966-70	727 small block	39.99	pr
MB2612M	1966-70	727 big block	39.99	pr
MB2613M	1966	Hemi Charger w/hidden headlights (4 pcs.)	74.99	set
MB2614M	1966-70	small block w/904 trans	39.99	pr
MB2615M	1970	Hemi w/auxiliary cooling (except Charger w/hidden headlights) 4 pcs.	74.99	set
ME5028M	1971-74	727 big block	39.99	pr
ME5027M	1971-74	727 small block	39.99	pr
MB2618M	1971-72	318 ci w/904	39.99	pr

Stainless Steel - B-Body				
MB2609S	1963-65	all vehicles, 2 lines	69.99	set
MB2610S	1966-69	Hemi w/auxiliary cooling (except Charger w/hidden headlights) 4 pcs.	114.99	set
MB2611S	1966-70	727 small block	69.99	pr
MB2612S	1966-70	727 big block	69.99	pr
MB2613S	1966	Hemi Charger w/hidden headlights (4 pcs.)	114.99	set
MB2614S	1966-70	small block w/904 trans	69.99	pr
MB2615S	1970	Hemi w/auxiliary cooling (except Charger w/hidden headlights) 4 pcs.	114.99	set
ME5028S	1971-74	727 big block	69.99	pr
ME5027S	1971-74	727 small block	69.99	pr
MB2618S	1971-72	318 ci w/904	69.99	pr

1970-74 E-Body Transmission Cooler Lines

Each line is manufactured using a special process that duplicates the correct bends that match factory original equipment. Couple precise manufacturing techniques with choice material selection and you can be sure that you are installing the best transmission cooler

lines on the market. These lines, produced in your choice of original steel or never-rust stainless steel, will fit your E-Body and save you the hassle of bending up your own lines. Applications available for E-Body vehicles such as Barracuda, 'Cuda and Challenger.

Original Material - E-Body				
ME5026M	1970-71	Hemi 3 lines	44.99	set
ME5027M	1970-74	727 or 904, 2 lines	39.99	pr
ME5028M	1970-74	727 big block, 2 lines	39.99	pr

Stainless Steel - E-Body				
ME5026S	1970-71	Hemi 3 lines	74.99	set
ME5027S	1970-74	727 or 904, 2 lines	69.99	pr
ME5028S	1970-74	727 big block, 2 lines	69.99	pr

Transmission Parts



B-Body Transmission Conversion Mount

Installing a 1966 or newer transmission into an early model B-Body Mopar just got easier, thanks to this unique B-Body transmission conversion mount for 1962-65 models! This handy mount eliminates the need for crossmember fabrication. Manufactured with high quality polyurethane. Made in USA.

MB2431 1962-65 conversion 129.99 ea

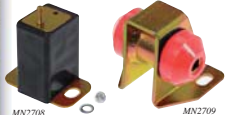

MN2708

MN2709

1967-76 Prothane Transmission Mount Sets

Polyurethane transmission mounts limit unwanted movement and control torque to transfer more energy to the wheels and also reduce the chance of breakage. Polyurethane mounts are very durable and resistant to oil, chemicals and road contaminants that deteriorate rubber mounts. Gain performance for the street or track with these nearly indestructible transmission mounts! Made in USA.

Note: *Charged mid-year.

MN2708	1967-72	A-Body	49.99 set
MN2709	1973-76	A-Body	49.99 set
MN2708	1966-70	B-Body	49.99 set
MN2709*	1971	B-Body	49.99 set
MN2709	1972-74	B-Body	49.99 set
MN2709	1970-74	E-Body	49.99 set



MD4228

1962-76 Polyurethane Transmission Mount

Schumacher polyurethane transmission mount for various 1962-76 Mopar muscle cars. These direct replacement mounts are designed to look like the originals while offering the strength and durability of polyurethane. Made in USA.

A-Body			
MD4228	1963-66	2-stud	129.99 ea
MD4229	1967-72	1-stud	129.99 ea
MD4230	1973-76	bolt-through	129.99 ea
B-Body			
MB2668	1962-65	w/auto	114.99 ea
MD4228	1962-65	w/4 speed	129.99 ea
MB2431	1965-65	conv to 66 & newer	129.99 ea
MD4229	1966-70	1-stud	129.99 ea
MD4230	1972-76	bolt-through	129.99 ea
E-Body			
MD4230	1970-74	bolt-through	129.99 ea



1963-76 Polyurethane Transmission Mounts

Energy Suspension offers an upgraded transmission mount with rigid and durable polyurethane construction for better performance and longevity. Polyurethane is unaffected by all automotive fluids and contaminants. Featuring strong interlocking metal construction, this mount replaces the complete original transmission mount and is for use with both automatic or manual transmissions. Available in red (R) or black (G) colored polyurethane. Please specify color code when ordering. Made in USA.

A-Body			
51112	1963-73	Dart, all	49.99 ea
51112	1967-69	Barracuda, all	49.99 ea
51112	1971-72	Demon, all	49.99 ea
51112	1971-76	Dart Swinger, all	49.99 ea
51112	1970-72	Duster, all	49.99 ea
51112	1973-76	Scamp, all	49.99 ea
51112	1960-76	Valiant, all	49.99 ea
B-Body			
51112	1966-71	Charger, all	49.99 ea
51112	1965-70	Coronet, all	49.99 ea
51112	1969-71	Road Runner, all	49.99 ea
51112	1969-71	Satellite, all	49.99 ea
E-Body			
51112	1970-71	all	49.99 ea



Polyurethane Transmission Mount Kit

Energy Suspension offers an upgrade to the Mopar transmission mount with rigid and durable polyurethane. For use with automatic or manual transmissions. Includes two polyurethane bushings and one metal sleeve to rebuild your original mount. Available in red (R) or black (G) colored polyurethane. Please specify color code when ordering. Note: Must reuse the original mounting bracket.

A-Body			
51101	1967-70	Dart, 318	16.99 kit
51101	1971-76	Dart, 318, 340, 360	16.99 kit
51101	1971-72	Demon, 318, 340	16.99 kit
51101	1971-76	Dart Swinger, all	16.99 kit
51101	1973-76	Duster, all	16.99 kit
51101	1973-76	Scamp, all	16.99 kit
51101	1973-76	Valiant, all	16.99 kit
B-Body			
51101	1969-70	Charger, 318, 440	16.99 kit
51101	1969-70	Coronet, 318, 440	16.99 kit
51101	1971-76	Charger, all	16.99 kit
51101	1972-74	Road Runner, all	16.99 kit
51101	1972-74	Satellite, all	16.99 kit
E-Body			
51101	1970-74	all	16.99 kit



Transmission Output Shaft Seal

Output shaft seal for Torqueflite 727 transmissions. This seal fits all versions of the transmission for all models. The transmission rear seal is easily replaced after removing the driveshaft. A new seal is cheap insurance against nasty leaks that can saturate the underside of the car with transmission fluid.

MN2190 all 11.99 ea



Internal/External Snap Ring Pliers

A handy combination tool for the removal or installation of internal and external snap rings.

Y46000 15.99 ea



Mopar Performance Kickdown Cables

Mopar Performance kickdown cables for engine and transmission swaps when production kickdown linkage will not work or is unavailable. Choose between the Torqueflite set that includes the bracket, spring and hardware or the cable alone for single 4-bl applications.

MN2236 Torqueflite 149.99 set



1962-76 Torqueflite Kickdown Cable Set

This complete kickdown kit for your Torqueflite transmission works on all 1962-76 carbureted, rear wheel drive Mopar models with Torqueflite transmission. Fit everything from 2 barrel 6 cylinders to Hemi and 440 Six-Packs, with just any other intake manifold. This patented kit gives you proper throttle pressure, correct shift points, versatile installation combinations, and provide longevity to your Torqueflite.

MN2236 1962-76 149.99 set
MN2238 replacement cable 109.99 ea

Transmission Parts



MN2375



MN2376



MN2378



MN2379

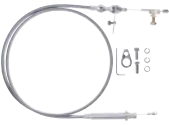

MN2381

Hi-Tech Kickdown Kits

Lokar's "U-Cut-to-Fit" Hi-Tech Kickdown Cables are designed with a specially extruded liner - not ordinary brake hose, and use aluminum fittings with ferrule to eliminate frayed cable ends and extend cable life. Available with a plain or polished black housing, a plain or polished stainless steel braided housing, or a black stainless steel braided housing. Adaptable for all types of manifolds including tunnel ram and blower manifolds. Complete instructions included.

Stainless Steel Housing	
MN2375 A 727.....	89.99 set
MN2376 A 904.....	81.99 set
Polished Stainless Steel Housing	
MN2381 A 727.....	104.99 set
MN2382 A 904.....	104.99 set
Black Stainless Steel Housing	
MN2377 A 727.....	89.99 set
MN2378 A 904.....	89.99 set
Black Housing	
MN2379 A 727.....	81.99 set
MN2380 A 904.....	81.99 set
Polished Black Housing	
MN2383 A 727.....	104.99 set
MN2384 A 904.....	104.99 set



Hammer Head T-Handle

This stylish Hammer Head T-handle, the same ergonomic handle on B&M Hammer shifters, fits all B&M shifters and most aftermarket and OEM (SAE or USS threads) shifters with 1/2"-20, 3/8"-24, 3/8"-16 & 5/16"-18-thread pattern.

Note: No further discounts apply.



223014 chrome aluminum finish.....41.99 ea



223009



223011



Grab a T-Handle for Positive Shift Results!

T-Handles fit all B&M and most other aftermarket and OEM shifters. Includes thread inserts to fit 1/2"-20, 3/8"-24, 3/8"-16, and 5/16"-18 thread shifters.

Note: No further discounts apply.

223009 T-handle chrome aluminum.....	34.99 ea
223010 T-handle brushed aluminum.....	29.99 ea
223011 T-handle black plastic.....	21.99 ea



223007



223012

B&M Round Shift Knobs

Grab a B&M round shift knob for a universal fit and classic or modern appearance. The high-impact, stain-resistant white shift knob or CNC-machined billet aluminum knob both feature the B&M logo and fit shift levers with 1/2"-20, 3/8"-24, 3/8"-16 or 5/16"-18 threads with adapters. Fits most B&M and other shifters with SAE or USS threads.

Note: No further discounts apply.



223007 SAE thread.....29.99 ea

Billet Shift Knob

223012 SAE thread.....59.99 ea



1530040

Hurst T-Handles

Add a Hurst T-Handle to your shifter for a firmer grip during shifting. Quality die-cast aluminum T-Handle is embossed with the familiar Hurst logo and comes in your choice of chrome, polished or brushed finish. Order direct fit by the size and finish. SAE universal fit includes adapters in 1/4"-28, 5/16"-18, 3/8"-16, 1/2"-20. Metric/SAE universal fit includes 3/8"-16, 3/8"-24, 7/16"-20, 1/2"-20, M10x1.25, M10x1.5, M12x1.25 and M12x1.75.

*Note: *Does not include SAE 3/8"-24 and 7/16"-20. No further discounts apply.*



1530032 SAE universal fit.....39.99 ea

Polished Aluminum T-Handle

1530040 Metric/SAE universal fit.....39.99 ea

Brushed Aluminum T-Handle

1530020* Metric/SAE universal fit.....34.99 ea



1630050



1530003

Competition Knobs/T-Handles with Switch

The Hurst Competition Knob and T-Handle features a heavy-duty, quick release 12 volt normally open switch with 24" long wire lead. Ideal for use with Roll/Control, trans brake, nitrous or other 12 volt accessory. Choose round solid plastic black knob or brushed finish aluminum T-Handle with embossed Hurst logo.

Note: No further discounts apply.



Round Plastic Knob With Switch

1630050 black knob 7/16"-20 thread.....71.99 ea

Aluminum T-Handle With Switch

1530003 Hurst T-Handle 3/8"-16 thread.....59.99 ea

Auto Shifter Components



1966-68 Console Shifter

Replace the worn shifter on your 1966-68 A or B-Body vehicle or convert your column shift car to floor shift with this brand new shifter assembly. This exact replacement features chrome knob with matching button. Fits 1966-68 A-Body models equipped with optional center console.

MD4010 1966-68 AT w/console..... 204.99 ea



1969-76 Console Shifter Assembly

Replace the worn shifter on your 1969-76 A-Body or 1969-70 B-Body vehicle or convert your column shift car to a floor shift vehicle with this brand new shifter assembly. This shifter features a woodgrain knob with black button. Fits 1969-76 A-Body models or 1969-70 B-Body models equipped with optional center console.

1969-76 A-Body MD4011 1969-76 AT w/console..... 204.99 ea

1969-70 B-Body MD4011 1969-70 AT w/console..... 204.99 ea



1966-70 Console Shift Lever Set

Replace the worn shift levers on your 1966-69 A-Body or 1966-70 B-Body. 1966-69 A-Body fits feedback, hardtop and convertible models equipped with optional center console including Barraquada and Dart.

1966-70 B-Body fits hardtop and convertible models equipped with optional center console.

AT w/Console MA2005 1966-69 A-body..... 158.99 set
MB564 1966-70 B-body..... 159.99 set



1964-68 Neutral Safety Switch

Replacement single post neutral safety switch for 1964 through 05/05/68 Mopar vehicles with automatic transmissions. This mounts to the transmission so that when the manual valve operating lever fingers press against the cone in park or neutral the vehicle will start.

MP700208 1964-68 automatic..... 64.99 ea



New!



1966-76 Lower Shifter Linkage Rods

Reproduction lower shift linkage rods for 1966-76 A, B, and E-Body models. These reproduction rods link the shifter torque shaft to the transmission control lever. Includes the swivel assembly.

MP71015 1967-76 A-Body..... 49.99 ea
MP71015 1966-70 B-Body..... 49.99 ea
MP71016 1970-76 B-Body..... 49.99 ea
MP71016 1971-74 E-Body..... 49.99 ea

New!



MD4012

1968-8 A & B-Body Shift Knob

Replace the worn or missing shift knob on your 1966-68 A or B-Body with these brand new shift knob parts. The knob assembly features chrome knob with chrome button. The replacement knob button is manufactured in plastic and chromed as original.

MD4012 1966-68 knob assembly..... 84.99 ea
MP80105 1966-68 button..... 24.99 ea



1968-76 Automatic Shift Knob

Replace the missing or worn shift knob assembly on your 1969-76 model or repair it with brand new parts from Classic Industries™. The complete assembly features a woodgrain knob with an 8-coil spring and a black button. Components are also sold separately.

Complete Assembly MD4013 1969-76 knob, button & spring 49.99 set

Individual Components
MD4014 1969-76 button, black..... 8.99 ea
MD4015 1969-76 spring, 8 coil..... 4.99 ea



1971-74 B-Body, E-Body Slap-Stik T-Handle

Replace the factory Slap-Stik T-handle in your 1971-74 B-Body or E-Body vehicle with our T-handle to match your original shifter's appearance. Includes the hard-to-find mounting screws and installation instructions. Fits vehicles equipped with factory Slap-Stik shifter, center console and automatic transmission. Made in USA.

MD4054 1971-74..... 49.99 ea



MD4031

MD4032

1970-74 B-Body & E-Body Slap-Stik to Pistol Grip Conversion Set

Add a pistol grip handle to the factory Slap-Stik shifter in your 1970-74 B-Body or E-Body vehicle. Provides for more control over shifting while eliminating the original shift ball on 1970 models or the troublesome factory T-handle on 1971-74 models. Woodgrain pistol grip handle with thumb rest provides for a very comfortable feel. Applications are available for 1970-74 B-Body and E-Body vehicles equipped with factory Slap-Stik shifter.

Pistol Grip Shift Handle Conversion Set

MD4031 1970 replaces ball..... 189.99 set
MD4032 1971-74 replaces T-handle..... 189.99 set

1966-70 B-Body Reverse Light Switch

Age certainly can take its toll on the plastics, metal springs and contacts within vintage electronic switches. Our brand new reverse

light switch for automatic transmission equipped 1966-70 B-Body vehicles can reverse the effects of aging and get your lighting working properly once again. Manufactured to exact specifications, each switch fits 1966-70 B-Body hardtop and convertible models equipped with optional center console.

MB568 1966-70 automatic..... 119.99 ea



MD2540

A-727 Gearshift Control Torque Bracket

Lower gearshift control torque bracket. This bracket fits various Mopar applications with floor-shifted 727 automatic transmissions and mounts to the transmission housing. Comes complete with correct conical nuts and correct style bushing.

A-Body MD2540 1966-74 all..... 34.99 ea

B-Body MD2540 1966-70 all..... 34.99 ea

MD2541 1971-74 with T-handle..... 34.99 ea

E-Body MD2540 1970 all..... 34.99 ea

MD2541 1971-74 with T-handle..... 34.99 ea



1967-74 Torque Shaft Bushing

Torque shaft bushing for column and floor shift automatic applications. Made from the correct natural nylon for an OE appearance.

MD2542 1967-74 2 required..... 4.99 ea

B&M Shifters



The Most Comfortable Shifter We Offer!

The B&M Hammer™ shifter may be the most comfortable automatic shifter you can buy. The handle feels like it was molded for your hand, and the spoon-shaped, multi-position trigger allows easy finger operation in a multitude of grip positions. For use with 1966 & later Torqueflite A727 & A904 3 speed automatic transmissions.

Important: Not for use with original consoles.
Note: No further discounts apply.

Key Features:

- Unique multi-positioned trigger for user comfort in various shifter positions.
- Base can be trimmed to custom fit any floor.
- Reverse lockout feature meets NHRA and IHRA requirements.
- Neutral safety switch, back-up light switch, lighted gear indicator, polished aluminum T-handle & cable.
- Can be used with a reverse pattern valve body.

223016 Hammer™ shifter..... 221.99 ea



High Performance Ratchet Action!

The Megashifter™ is one of B&M's all-time classic designs due to timeless good looks and high performance ratchet action. It's ideally suited for most popular applications that use a 1966 & later Torqueflite A727 & A904 3 speed automatic transmissions.

Important: Not for use with original consoles.
Note: No further discounts apply.

Key Features:

- Universal floor mount application. Base can be trimmed to custom fit any floor.
- Cable operated for quick installation and accurate shifting.
- Neutral safety switch, backup light switch, lighted gear indicator, polished aluminum T-handle, & cable.
- Can be used with a reverse pattern valve body.

223017 Megashifter™ shifter..... 324.99 ea



Classic Style and Stout Performance!

The B&M QuickSilver™ shifter is a top of the line ratchet action shifter that provides performance shifting without a trigger. To get into park or reverse from forward, just lift the knob/stick assembly and move it forward into position! And it's cable operated for easy installation and precise shifting. For use with 1966 & later Torqueflite A727 & A904 3 speed automatic transmissions.

Important: Not for use with original consoles.
Note: No further discounts apply.

Key Features:

- Universal floor mount application. Base can be trimmed to custom fit any floor.
- Cable operated for quick installation and accurate shifting. You can't miss a gear.
- Neutral safety switch, back-up light switch, lighted gear indicator, chrome knob & cable.
- Can be used with a reverse pattern valve body.

223018 QuickSilver™ shifter..... 291.99 ea



The Perfect Shifter for Your Daily Driver!

The Sport Shifter™ is the low cost alternative to B&M's top of the line MegaShifter™ that performs as if it was twice the price! The Sport Shifter™ is not a ratchet shifter and not intended for racing applications, but it makes a perfect addition to any street machine - making daily driving something to look forward to. Utilizing a simple detent action between First, Second, High and Neutral, it features a lighted gear indicator, black plastic T-handle, neutral safety switch, back-up light switch and flat aluminum stick. For use with 1966 & later Torqueflite A727 & A904 3 speed automatic transmissions.

Important: Not for use with original consoles.
Note: No further discounts apply.

Key Features:

- Base can be trimmed to custom fit any floor.
- Neutral safety switch, back-up light switch, lighted gear indicator, black T-handle & cable.

223019 Sport Shifter™ shifter..... 214.99 ea



Straight Line Detent Shifter with Timeless Style!

The B&M StarShifter is a versatile three speed automatic shifter in a clean, timeless styled package! In normal mode, the StarShifter is a straight line detent shifter. With the lever is in Low, lift the trigger and pull the stick back to convert to ratchet action. Move the stick forward for the 1-2 and 2-3 shifts. Cannot be used with reverse pattern valve body. For use with 1966 & later Torqueflite A727 & A904 automatic transmissions.

Important: Not for use with original consoles.
Note: No further discounts apply.

Key Features:

- Base can be trimmed to custom fit any floor.
- Cable operated for quick installation and accurate shifting.
- Reverse lockout feature meets NHRA and IHRA requirements.
- Neutral safety switch & polished aluminum T-handle & cable.

223020 StarShifter™ shifter..... 199.99 ea



More Bang for the Buck!

The B&M Z-Gate™ shifter combines classic styling, performance, and a popular price. If you're building a project on a budget, or simply want to upgrade your automatic shifter, the Z-Gate™ is the only choice! Great for most 3-speed automatics, the patented Z-shaped architecture eliminates the possibility of overshifting and missing a gear. Even more, this easy to operate shifter has many of the features found in our top of the line units, and it includes a T-handle and T-trigger - so you get the most bang for your buck! For use with 1966 & later Torqueflite A727 & A904 automatic transmissions.

Important: Not for use with original consoles.
Note: No further discounts apply.

Key Features:

- Base can be trimmed to custom fit any floor.
- Reverse lockout feature meets NHRA and IHRA requirements.
- Neutral safety switch, back-up light switch, black T-handle & cable.

223021 Z-Gate™ shifter..... 189.99 ea

Shifter & Components

New!



FMS6727EM

LOKAR



XFMS6727EB

Floor Mount Shifters

Upgrade the shifter in your classic with one of these premium Lokar floor mounted shifters. Designed to operate on solid adjustable linkage, these shifters include the neutral safety switch with positive safety lockout in park and neutral. They also feature gold iridized brackets and a teflon lined button for smooth operation. These shifters for bucket seats include an 8", 10" and 12" chrome or black handle, and the bench seat shifter includes a 16" curved chrome or black handle. Includes a mushroom style knob with a brushed finish or black anodized finish. All mounting hardware and instructions are included.

Chrome Handle w/Brushed Finish Knob

Bucket Seats			
FMS6727CM	727	12"	269.99 ea
FMS6727DM	727	10"	269.99 ea
FMS6727EM	727	8"	269.99 ea
FMS6904CM	904	12"	269.99 ea
FMS6904DM	904	10"	269.99 ea
FMS6904EM	904	8"	269.99 ea
Bench Seats			
FMS6727GM	727	16"	304.99 ea
FMS6904GM	904	16"	304.99 ea

Black Handle w/Black Anodized Knob

Bucket Seats			
XFMS6727CB	727	12"	269.99 ea
XFMS6727DB	727	10"	269.99 ea
XFMS6727EB	727	8"	269.99 ea
XFMS6904CB	904	12"	269.99 ea
XFMS6904DB	904	10"	269.99 ea
XFMS6904EB	904	8"	269.99 ea
Bench Seats			
XFMS6727GB	727	16"	304.99 ea
XFMS6904GB	904	16"	304.99 ea



MN2580



MN2584

American
SHIFTER COMPANY

1960-76 Single & Dual Action Automatic Shifters

These shifters are manufactured from steel and offer unique front, mid, and rear mounting options, multi axis adjustments, and true craftsmanship. Available with single-action push-button operation, or combination push-button and side-shift dual-action. Shift however you want!

Important: You can use any shift knob with the dual action shifter but will lose the push button operation.

Note: Single action shifters will work with factory consoles but are not direct factory replacements, single action shifter moves in a straight line that will allow you to position the console in the stock or rear-stock location.

Single Action Shifters

1960-76 Torqueflite 727 Transmission			
MN2512	8"	arm with black knob	229.99 ea
MN2513	8"	arm with deluxe knob	239.99 ea
MN2514	10"	arm with black knob	229.99 ea
MN2515	10"	arm with deluxe knob	239.99 ea
MN2516	12"	arm with black knob	235.99 ea
MN2543	12"	arm with deluxe knob	245.99 ea
1960-76 Torqueflite 904 Transmission			
MN2544	8"	arm with black knob	229.99 ea
MN2545	8"	arm with deluxe knob	239.99 ea
MN2546	10"	arm with black knob	229.99 ea
MN2547	10"	arm with deluxe knob	239.99 ea
MN2548	12"	arm with black knob	235.99 ea
MN2549	12"	arm with deluxe knob	245.99 ea

Dual Action Shifters

1960-76 Torqueflite 727 Transmission			
MN2578	8"	arm with black knob	279.99 ea
MN2579	8"	arm with deluxe knob	289.99 ea
MN2580	10"	arm with black knob	279.99 ea
MN2581	10"	arm with deluxe knob	289.99 ea
MN2582	12"	arm with black knob	285.99 ea
MN2583	12"	arm with deluxe knob	295.99 ea
1960-76 Torqueflite 904 Transmission			
MN2584	8"	arm with black knob	279.99 ea
MN2585	8"	arm with deluxe knob	289.99 ea
MN2586	10"	arm with black knob	279.99 ea
MN2587	10"	arm with deluxe knob	289.99 ea
MN2588	12"	arm with black knob	285.99 ea
MN2589	12"	arm with deluxe knob	295.99 ea



MN2573



MN2574



MN2575



MN2576



MN2577

American
SHIFTER COMPANY

Shifter Accessories

Add a touch of elegance to your vehicle with these shifter accessories. The nostalgic chrome cap installs easily on vertical shift boots to accent the shift lever, while the boot kits dress up your shifter with a synthetic leather boot in your choice of black, gray, or tan. Finish off your shifter with a precision stamped stainless steel trim ring, mount screw openings for a smooth look.

Nostalgic Chrome Cap

MN2573 chrome cap 7.99 ea

Shifter Boots

MN2574 black boot 19.99 ea

MN2575 gray boot 19.99 ea

MN2576 tan boot 19.99 ea

Round Boot Trim Ring with Hardware

MN2577 trim ring 19.99 ea

Hurst Shifters



Pistol-Grip Quarter Stick Provides a Firm Natural Grip!

The Hurst Pistol-Grip Quarter Stick automatic shifter is designed for a firm comfortable natural grip, providing a positive feel when shifting. The Pistol-Grip handle is CNC-machined from billet aluminum and features a precision snap action thumb switch that is ideal for operating a Hurst Roll/Control, nitrous system or trans brake. Optional shifter cover can be trimmed to fit any floorpan. For a stock console look, choose the distinctive black textured plastic cover kit. Or, for a racier look, order the aluminum cover kit that attaches to the shifter with 2 quick release pins. Both are sold separately. The Hurst Pistol-Grip Quarter Stick fits Mopar A727, A904 transmissions.

Important: For use on vehicles without factory consoles.
Note: No further discounts apply.

Key Features:

- Forged aluminum stick.
- CNC Machined Billet Pistol-Grip handle.
- Snap action thumb switch for operating roll/control, nitrous or trans brake.
- One-hand operated, spring loaded reverse lock-out mechanism.
- Factory installed neutral safety switch.
- Cable operated.
- Optional cover kits sold separately.

Reverse Valve Body

3162014 A727, A904.....364.99 ea



3160009

The Floor Mount Hurst Quarterstick Provides a Positive Shift Feel!

The Hurst Quarter Stick automatic shifter is designed to provide positive gear change control for street or strip applications. Detent activation is controlled by a chrome plated trigger contoured to fit comfortably into the driver's hand. Optional shifter cover can be trimmed to fit any floorpan. For a stock console look, choose the distinctive black textured plastic cover kit. Or, for a racier look, pick the aluminum cover kit that attaches to the shifter with 2 quick release pins. Both are sold separately. The Hurst Quarter Stick shifter fits A727 and A904 transmissions.

Important: For use on vehicles without factory consoles.
Note: No further discounts apply.

Key Features:

- Forged aluminum stick.
- One-hand operated, spring loaded reverse lock-out mechanism.
- Factory installed neutral safety switch.
- Cable operated.
- Optional cover kits sold separately.

Forward Valve Body

3160009 A727, A904.....279.99 ea

Reverse Valve Body

3160014 A727, A904.....279.99 ea



New!



1531000

1536210

Universal Pistol-Grip Shifter Handle

Need a serious grip for power shifts? Wrap your hand around the Hurst pistol grip shifter handle! It's designed to provide a firm, natural grip to help prevent missed shifts. Manufactured from aluminum featuring the Hurst name embossed on both sides. Available with a 12 volt 10 amp normally open switch to operate roll control, nitrous, or other accessories. Choose from natural and black anodized finishes. The handle has a 16mm-1.50 internal thread and includes jam nuts as well as the following SAE and Metric adapters: 3/8"-16, 1/2"-20, 10mm-1.25, 10mm-1.50, 12mm-1.25, & 12mm-1.75.

Note: No further discounts apply.

1531000 natural finish.....54.99 ea
1536200 natural finish with switch.....69.99 ea
1536210 black finish with switch.....69.99 ea



1300055



1300041

Quarter Stick Covers Come in Two Distinctive Styles!

One of the nice features of the Hurst Quarter Stick Shifter is the ability for you to choose the finished look you want through the availability of two distinctive cover kit designs.

Important: For use on vehicles without factory consoles.

Note: No further discounts apply.

Style One-Plastic Cover Set:

- Adds a "factory option" look to your Hurst shifter.
- Textured black plastic can be trimmed to fit any floor contour.
- Mounting plate & button head screws are included.

1300055 plastic cover set.....84.99 set



Style Two-Aluminum Cover Set:

- Adds a "race car" look to your Hurst shifter.
- Attaches to shifter with two quick release pins.

1300041 aluminum cover set.....74.99 set

Retro Hurst Emblem



Based on original Hurst blueprints, this Hurst

Equipped emblem is an authentic reproduction of the one used on the late 60's muscle cars. Equipped with a factory Hurst shifter. Made of durable ABS plastic with 3M adhesive tape backing for permanent mounting. Measures 1-1/4" x 5-1/4".
1361000 Hurst Equipped emblem.....19.99 ea

Manual Transmission



American
SHIFTER COMPANY

Billiard Ball Shift Knobs

These billiard shift knobs are made from authentic, 2-1/4" diameter billiard balls with precision threaded adapter inserts to ensure a snug fit in your vehicle. This unique knob will provide a smooth, solid shift feeling. Choose the classic 8-ball or the ball of your favorite color! Shift balls include a built in 16mm x 1.5 threaded insert with jamb nut and detailed instructions for easy installation. Adaptors for other thread sizes are available separately.

MN2550	1 ball	19.99 ea
MN2551	2 ball	19.99 ea
MN2552	3 ball	19.99 ea
MN2553	4 ball	19.99 ea
MN2554	5 ball	19.99 ea
MN2555	6 ball	19.99 ea
MN2556	7 ball	19.99 ea
MN2557	8 ball	14.99 ea
MN2558	9 ball	19.99 ea
MN2559	10 ball	19.99 ea
MN2560	11 ball	19.99 ea
MN2561	12 ball	19.99 ea
MN2562	13 ball	19.99 ea
MN2563	14 ball	19.99 ea
MN2564	15 ball	19.99 ea
MN2565	white 8 ball with red center	29.99 ea



MN2566

MN2567



MN2568

MN2569



MN2570

MN2571

American
SHIFTER COMPANY

Cue Ball Shift Knobs

These cue ball shift knobs are 2-1/4" in diameter and come with a built-in precision threaded insert that includes adapters to ensure a snug fit. Made from authentic unused billiard cue balls. Choose from the most popular shift patterns. Shift balls include a built in 16mm x 1.5 threaded insert with jamb nut and detailed instructions for easy installation. Adaptors for other thread sizes are available separately.

MN2566	4-speed	29.99 ea
MN2567	4-speed	29.99 ea
MN2568	5-speed	29.99 ea
MN2569	5-speed	29.99 ea
MN2570	6-speed	29.99 ea
MN2571	6-speed	29.99 ea



Transmission Rebuild Set for A-833

Classic Industries® has put together a comprehensive transmission rebuild set for all Chrysler A-833 transmissions. Set includes large and small bearing sizes to accommodate all applications. Comes with all the gaskets, seals, synchro rings and all small items needed to rebuild your transmission.

MN2374 259.99 set

New!



CB40043



natural



black



grey

Ringbrothers Billet Clutch Reservoir

This Ringbrothers billet clutch reservoir will add some high tech look under the hood. Machined from 6061-T6 billet aluminum. Replaces the stock GM plastic clutch reservoir for hydraulic clutches. Accepts 1/8" NPT to AN fitting. Includes mounting bracket and 5/16" nickel plated hose barb fitting. Available in natural, black and grey finishes. Can be used for many custom applications.

CB40043	natural	134.99 ea
CB40044	black	144.99 ea
CB40045	grey	144.99 ea



Royal Purple Synchronax

This manual transmission fluid increases performance and the life of your equipment. It improves shifting, reduces gear noise and increases power transfer to the wheels. It also lowers operating temperatures and provides outstanding wear protection for longer transmission life. Synchronax is recommended for manual transmissions that specify an automatic transmission fluid. It's also ideal for 4x4 transfer cases and motorcycle gear boxes. Synchronax is fully compatible with all types of friction materials. It provides excellent corrosion and oxidation protection without affecting the soft metals commonly found in manual transmission synchronizers. Synchronax is formulated with Royal Purple's proprietary Synerlec technology for unsurpassed performance and protection.

RP01512	quart	18.99 ea
RP12512	case of 12 qts.	205.99 ea



Manual Transmission Fluid

This 80W lightweight fully synthetic manual transmission oil reduces parasitic drag and provides race proven protection.

JG1206	quart	19.99 ea
JG1207	case of 12 qts.	239.99 ea



Clutch Pilot Bushing

Clutch pilot bushings fit on the input shaft of manual transmissions and can cause hard shifting and increase transmission wear when worn out. When changing your clutch, use one of these new bronze pilot bushings for best results.

MN2187	all	8.99 ea
--------	-----	---------

McLeod Flywheels

McLeod Steel Flywheels

For easy stoplight acceleration, these flywheels are ideal. The mass of these steel flywheels makes them perfect for launching a heavy car with a smaller engine with less torque and horsepower. If you have multiple engines that require different balance on the flywheel, you can add or remove weights as required, without buying another flywheel.

Note: *Flywheels use Bendix type starters.

Clutch Pattern Notes:

- 10", 10.5", 10.95" B&B Diaphragm
- 11", 12" B&B Diaphragm with shouldered bolts
- 10", 10.5" LONG & 10" Diaphragm
- 11" LONG with 3/8" bolt holes

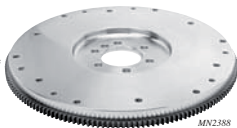

MN2388



MD2538

13.195" Ring Bear O.D. (See Notes 4 and 5)					
Part #	Years	Engine	Description	Teeth	
MN2388	1964-76	318, 340	6 bolt crank	130	349.99 ea
MN2389	1972-73	340 w/counterbalance	sml. fly. w/6 bolt crank w/cast	130	359.99 ea
MN2390	1968-76	360	sml. fly. w/6 bolt crank	130	359.99 ea
MN2391	1964-76	383, 400 & 440	6 bolt crank	130	349.99 ea
MN2391	1970-71	383, 400 w/counterbalance	6 bolt crank w/cast	130	359.99 ea
MN2392	1970-72	440 w/counterbalance	w/4bbl & 6bbl 6 bolt crank	130	359.99 ea
MN2391	1973-76	440 w/counterbalance	sml. fly. w/6 bolt crank w/cast	130	359.99 ea
MN2393	1963-72	426 Wedge & Hemi	sml. fly. w/8 bolt crank	130	349.99 ea
14.568" Ring Bear O.D. (See Notes 4, 5 and 8)					
MN2394	1960-76	383, 400	lrg. fly. 0 balance, 6 bolt crank	143	379.99 ea
MN2395	1966-69	426 Wedge & Hemi	lrg. fly. 8 bolt crank	143	379.99 ea
MN2396	1970-72	440 w/counterbalance	w/4bbl & 6bbl 6 bolt crank	143	399.99 ea
MN2397	1973-76	440 w/counterbalance	6 bolt crank w/cast	143	389.99 ea
16.640" Ring Bear O.D. (See Notes 4, 5 and 8)					
MN2398*	1960-61	311, 354 & 392 Hemi	8 bolt crank, sml. crank bolts	172	469.99 ea
MN2399*	1966-69	426 Street Hemi	lrg. fly. 8 bolt crank	172	469.99 ea



counterbalance weight hole locations



counterbalance weight bolted to flywheel



counterbalance weights for various applications

McLeod Steel Flywheel Weights

McLeod flywheels are designed to have counterweight simply bolted on to accommodate various engine applications. If you have multiple engines that require different flywheel balance, you can add or remove counterweights and use this even on an internally balanced motor, saving you the cost of buying a new flywheel.

Part #	Year	Engine	Application	C/B Location	Weight in Grams	Inch (Ounce)
460007	1972-73	340	w/cast crank only	A	12	4.22..... 41.99 ea
MN2401	1971-76	360	all models	A	109	19.79..... 41.99 ea
MN2402	1970-71	383, 400	w/cast crank only	C	64.5	12.9..... 41.99 ea
MN2403	1970-72	440	4bbl & 6bbl only	C	30.1	6.5..... 41.99 ea
MN2402	1973-76	440	w/cast crank only	C	64.5	12.9..... 41.99 ea

Engine	Year	Crank	Engine	Year	Crank
273	1964-69	All	383HP	1970-71	Steel
318	1967-76	All	400HP	1972	Steel
340	1968-72	Steel	413	1964-65	Steel
361	1964-67	All	426W	1964-66	Steel
383	1964-71	Steel	440	1966-72	Steel

1964-76 OEM Flywheel

These replacement flywheels are designed for various Chrysler 1964-76 models that use a 10.5" or 10.95" clutch.

MD2538 1964-76 except 360 439.99 ea

MN2387 1971-76 360 only 349.99 ea



HD1503



HD1593

RAM Billet Steel Flywheel

RAM billet steel flywheels are recommended as a replacement for factory cast flywheels in high performance and racing vehicles. Cast flywheels are not explosion proof and can be dangerous when used in high performance applications at higher RPMs. RAM billet steel flywheels are CNC machined from certified materials and exceed SFI specifications. After machining, the flywheels are blanchard ground parallel to the crankshaft mounting surface ensuring minimum runout and the optimum mating surface for the variety of friction materials they offer. Use steel flywheels in heavier drag race models or for the best drivability in street driven vehicles.

Note: No further discounts apply.

Part #	Year	Engine	Application	C/B Location	Weight in Grams	Inch (Ounce)
130-Tooth '0' Balance Flywheels						
H1503		6 bolt crank				299.99 ea
H1583		8 bolt crank				299.99 ea
143-Tooth '0' Balance Flywheels						
H1595		6 bolt crank				319.99 ea
H1593		8 bolt crank				329.99 ea

Flywheel & Clutch



88766

1962-76 8 Cylinder Clutch Sets

Ram clutch sets contain correct, high quality replacement parts to ensure proper fit and operation in your vehicle. These clutch sets are for models that are stock or have minor modifications. Each set contains clutch disc, pressure plate, throw out bearing and alignment tool. Each disc carries a 1 year/12,000 mile manufacturer's warranty from date of purchase.

Note: No further discounts apply.

88766	All w/23 spline 10.5" clutch	194.99	set
88503	All w/18 spline 10.95" clutch	294.99	set
88773	All w/23 spline 10.95" clutch	251.99	set
88504	All w/18 spline 11" clutch	299.99	set
88768	All w/23 spline 11" clutch	194.99	set



88766H

1962-76 V8 HDX Clutch Sets

HDX Clutch sets are the performance upgrade for your daily driver/hot rod. Pressure plates feature increased clamp loads and our 200 Series organic clutch disc use a premium organic facing material that greatly increases rotational strength. Use HDX sets for models with bolt on mods and mild power enhancements, for street or strip. Each set contains clutch disc, pressure plate, throw out bearing and alignment tool.

Note: No further discounts apply.

88766H	all w/23 spline 10.5" clutch	323.99	set
88503H	all w/18 spline 10.95" clutch	319.99	set
88773H	all w/23 spline 10.95" clutch	314.99	set
88504H	all w/18 spline 11" clutch	319.99	set
88768H	all w/23 spline 11" clutch	299.99	set



New!



MD2578

1962-74 Flywheel Cover

Reproduction flywheel inspection covers for 1962-74 models. Available in or ABS plastic, these are manufactured to original specifications and will replace the original cover exactly.

Cast Iron Bellhousing

Big Block with 11" Cover			
MD2577	1966-69	ABS plastic	41.99 ea

Aluminum Bellhousing

Big Block with 10-1/2" Cover			
MD2578	1970-74	ABS plastic	41.99 ea



MD2532



MD2533



MD2534

1962-76 Clutch Fork & Clutch

Replacement clutch fork, boot, and components for various 1962-76 A, B, and E-Body models.

Clutch Fork & Boot Set

B & E-Body - OEM			
MD2532	1962-76	w/LA-series V8...	67.99 set

Clutch Fork Boot

A, B, & E-Body - Reproduction			
MD2529	1964-74	w/4-spd or 3-spd column shift	24.99 ea

Replacement Hardware

B & E-Body - OEM			
MD2533	1962-76	clutch fork rod adjustment nut	2.99 ea
MD2534	1962-76	clutch fork rod washer	9.99 ea



MD2529



MD2530

1966-76 Clutch Rod Service Kit

Kit provides all components necessary to service the clutch adjusting rod. Includes adjusting rod, special lock nut, clutch fork return spring, nylon wear washer, spring retainer, conical washer, and clutch fork insulator.

A-Body			
MA2329	1967-76	small block	44.99 kit
B & E-Body			
MD2530	1966-70	small block	44.99 kit
MD2531	1971-74	big block	44.99 kit

New!



MB2298



MB2297



MB2430

1962-76 Bell Crank/Z-Bar

Replacement bell crank, also known as a "Z-bar," for 1962-76 Mopar models. Each bell crank is designed to replace the original exactly.

A-Body			
MA2295	1962-63	small block	91.99 ea
MA2495	1964-66	small block	73.99 ea
MA2296	1967-76	big block	73.99 ea
MA2297	1967-76	small block	73.99 ea
MA2298	1967-76	L6	73.99 ea
B-Body			
MB2429	1962-65	all V8	73.99 ea
MB2430	1966-72	big block	73.99 ea
E-Body			
MB2430	1970-71	big block	73.99 ea

Manual Transmission Parts



1962-76 Replacement Clutch Linkage Parts

Replacement clutch linkage parts for various Mopar A, B, and E-Body models. Made in USA.

Bell Crank Ball Stud Nylon Bearing	
MD2517 1962-76 2 pairs required.....	4.99 pr
Bell Crank Ball Stud Rubber Seal	
MD2518 1962-76 2 required	5.99 ea
Bell Crank Bearing Retaining Wire	
MD2519 1962-76	7.99 ea
Bell Crank Nylon Wear Washer	
MD2523 1962-76	1.99 ea
Bell Crank Linkage Spring Clip	
MD7078 1962-76 3 required	2.99 ea



B & E-Body Bell Crank Frame Bracket Kit

The complete frame bracket and ball stud kit for B and E-Body models. Includes the frame bracket, both ball studs, flat washer and nut. A must when converting from automatic to 4 or 5 speed. Made in USA.

MD2522 1966-74 bracket kit.....	44.99 kit
---------------------------------	-----------



1963-76 Bell Crank Ball Studs

Clutch bell crank ball studs for all manual transmission A, B & E-Body models. Each stud is zinc plated for an original appearance.

Frame-Side Ball Stud	
MD7076 1965-76 A/B/E frame	14.99 kit

Engine-Side Ball Stud	
------------------------------	--

A-Body	
MA2292 1967-68 big block.....	74.99 ea
MA2289 1968-71 small block	19.99 ea
MB2427 1969 big block.....	74.99 ea

B-Body	
MA2290 1963-64 big block.....	40.99 ea
MA2291 1965 B-Body.....	24.99 ea
MD7077 1966-76 B-Body.....	14.99 ea

E-Body	
MD7077 1970-74 B, E-Body.....	14.99 ea

Engine Side Spacer	
MB2426 1967-69 big block.....	36.99 ea



1966-74 Clutch Linkage Service Kit

A complete kit to replace the clutch shaft linkage from the clutch pedal to the clutch fork. Each kit contains nylon bearings, snap rings, seals, washers, lock springs, pivot ball studs and instructions. Made in USA.

MA2330 1968-71 A-Body.....	59.99 kit
MD7074 1966-74 B & E-Body.....	59.99 kit



1966-74 B & E-Body Torque Shaft Bracket

Excellent replacement of the original torque shaft bracket installed on 1966-74 B and E-Body vehicles. This is the steel bracket welded to the frame on all B and E-Body models. The frame side ball stud mounts into this bracket. This bracket is required when converting to a manual transmission. Made in USA.

MD2535 1966-74 B & E-Body.....	24.99 ea
--------------------------------	----------



1967-74 A, B, E-Body Firewall Clutch Boot

This seals the hole in the firewall where the manual transmission pedal rod goes through to the clutch counter shaft.

MD2514 1967-74 A, B-Body	3.99 ea
MD2514 1970-74 E-Body	3.99 ea



1968-74 Clutch Pedal Push Rod

This is a replacement of the clutch pedal push rod for Models equipped with a 4 speed transmission.

MA2327 1968-72 A-Body.....	19.99 ea
MB2456 1968-70 B-Body.....	19.99 ea
MD2524 1971-74 B-Body.....	19.99 ea
MD2524 1970-74 E-Body.....	19.99 ea



1970-74 Manual Pedal Kit

Replacement pedal assembly kit for 1971-74 B-Body and 1970-74 E-Body models. Includes the brake and clutch pedals, bracket, spring and shaft.

ME1004 1970-74 pedal kit.....	204.99 kit
-------------------------------	------------



1963-74 Clutch Pedal Stop Bumper

Clutch pedal stop bumper for various 1963-74 Dodge and Plymouth applications.

MD2526 1963-74 pedal stop bumper	5.99 ea
--	---------



1970-74 Clutch Pedal Bracket Retainer

Clutch pedal bracket stud retainer. This retainer installs in the engine side of the firewall and secures the clutch pedal bracket on the interior side. A must when converting from an automatic to a 4 speed.

MD2512 1970-74 E-Body	47.99 ea
MD2512 1971-74 B-Body	47.99 ea



1966-76 Clutch Adjusting Rod

Clutch adjusting rod. This rod connects the clutch fork to the linkage and is threaded to allow adjustment. High strength heat treated alloy steel. Zinc plated as original.

A-Body	
MA2328 1967-76 A-Body, 7.5" L.....	26.99 ea
B & E-Body	
MD2527 1966-70 small block, 15" bend	26.99 ea
MD2528 1971-74 big block, 4.88" L.....	26.99 ea

New!



1970-74 Clutch Pedal Return Spring

Heavy duty reproduction clutch pedal return spring for 1970-74 E-Body and 1971-74 B-Body models with 4-speed manual transmissions.

MP800101 1970-74 E-Body models.....	31.99 ea
MP800101 1971-74 B-Body models.....	31.99 ea

Manual Transmission Shifters



3916789



1965-72 B-Body Hurst Shifter

This Hurst Competition/Plus performance shifter features heat-treated linkage rods and arms for strength and durability and adjustable gear-stops to prevent oversifting. Includes the shift mechanism, chrome plated stick and custom white knob. Installation kit is sold separately. Fits 1965-72 Mopar B-Body applications.

Note: No further discounts apply.
3916789 1965-72 B-Body w/o console... 359.99 ea



1965-72 B-Body Hurst Shifter Install Set

Needed to install the Hurst Competition/Plus Shifter this set includes linkage rods, shift arms, shifter mounting plate and hardware.

Note: No further discounts apply.
3734089 1965-72 B-Body w/o console 199.99 set



HURST Indy SSA 3 Speed Shifter

This universal shifter fits a wide variety of applications and is ideal for converting column shift 3-speeds to floor shift without console. Features a spring-loaded gate for ease of operation and short, precise throws for less stick travel. Chrome plated stick with black knob. All components are plated for protection. Includes shifter boot, hardware and instructions. Some modification may be necessary during installation.

Note: No further discounts apply.
5010002 249.99 ea



3320001



Hurst Linkage Rod Bushings & Clips

This is a set of either steel or nylon bushings and clips for the ends of the Hurst linkage to take the "slop" out of the shift rods. For 3, 4 and 5-speed manuals.

Note: No further discounts apply.
3320001 nylon bushings 11.99 set
3327302 steel bushings 12.99 set



MD4030

1970-74 B & E-Body Pistol Grip Shifter Sets & Components

Replace the Hurst pistol grip shifter in your 4-speed equipped 1970-74 B-Body or E-Body vehicle with our brand new grips, bezels and inserts. We have a variety of components to make your worn shifter look like new. The grips are very close to original in color, shape and grain pattern. The upper and lower bezels are manufactured of chrome plated die-cast zinc. The plastic shift pattern inserts are available for original 4-speed pattern. A variety of applications are available for 1970-74 B-Body and E-Body vehicles equipped with Hurst pistol grip shifter.

Complete Set

Includes 4-speed insert, upper bezel, lower bezel, grips and screws

MD4030 1970-74 8 piece set 114.99 set

Individual Components

Upper Bezel
MD4017 1970-74 chrome die cast zinc . 29.99 ea
Shift Pattern Insert
MD4018 1970-74 4-speed 14.99 ea
Shifter Grip Set
MD4019 1970-74 woodgrain plastic 39.99 set
Lower Bezel
MD4020 1970-74 chrome die cast zinc . 29.99 ea



Chrome Shift Knob

This highly polished, triple chrome plated heavy weight shift knob will add a unique appearance to your interior.

Note: Must be installed on aftermarket shifters which have the correct thread size.
9793565 3/8" Hurst type shifters 19.99 ea



MD4016

MD4027

MD4028

1970-74 B-Body & E-Body Custom Grips for Hurst Shifters

Give the Hurst pistol grip shifter in your 4 speed equipped 1970-74 B-Body or E-Body vehicle a custom look. Replacement grips are offered in a variety of custom finishes including Burwood, Black or Carbon Fiber. Fits 1970-74 B-Body and E-Body vehicles equipped with Hurst pistol grip shifter. Includes screws for installation.

Replacement Grip Set

MD4016 1970-74 burwood grain plastic . 49.99 set
MD4027 1970-74 black plastic 49.99 set
MD4028 1970-74 carbon fiber 69.99 set

New!



1630040



Hurst Classic White Shift Knob

These solid white shift knobs are perfect for classic vehicles that have been upgraded with a modern five or six speed transmission. Each 1-3/4" shift knob features an engraved and inlaid black gate shift pattern. 3/8-16 thread size. Includes jamb nut.

Note: No further discounts apply.
1630008 5-speed shift knob 41.99 ea
1630040 6-speed shift knob 39.99 ea

New!



1530041

Reproduction Hurst Shift Handle

Get a firm grip on your shifters with this licensed reproduction Hurst T-Handle shifter knob! This shift handle is embossed with the Hurst "H" logo and 4-speed shift pattern for a true muscle car look. Available in your choice of black or white molded plastic.

Note: Jamb nut not included.
1530041 black handle with 3/8" thread . 44.99 ea
1530043 white handle with 3/8" thread . 44.99 ea

Shifter Accessories

New!



MP80101



MP88100



MA759



MA760



FMB71

Floor Mount Shifter Boot and Ring

Floor mount shifter boots and retaining ring are the perfect match for Lokar's floor mount shifters. Available with a stunning black billet steel, brilliant billet aluminum or beautiful black billet aluminum mounting ring. Inner ring dimensions measure 5-1/2" x 4". Outer ring dimensions are 6-3/4" x 5-1/4".

FMB70 stainless steel.....	39.99 ea
FMB71 billet aluminum.....	64.99 ea
FMB72 black billet aluminum.....	64.99 ea



MD4006



MA761



MP80102



MP80103



MP80104



MB561



MN1752



MB560



MB562



MD4007



MD4008



MB761



MD4009

1963-74 Shifter Boots and Bezels

Replace your deteriorated or missing shift boot to seal the area around the shifter mechanism just like the factory intended. Upper boots seal the area where the shifter protrudes through the console on console-equipped Models. Lower boots seal the area where the shift mechanism passes through the floor panel. A variety of applications are available for 1963-76 A-Body, B-Body and E-Body vehicles.

Note: *Not correct for 1971-72 B-Body Models with bench seat or bucket seats with fold-down armrest.

A-Body Shifter Boots

Manual Transmission	
MP80101 1963-65 floor-type.....	99.99 ea
MP88100 1966-68 w/A383 shifter.....	49.99 ea
MA759 1966-76 upper, w/console.....	74.99 ea
MA760 1966-76 lower.....	41.99 ea
Automatic Transmission	
MD4006 1966-74 lower, w/console.....	31.99 ea

A-Body Shifter Boot Bezels

MA761 1966-76 w/o console.....	19.99 ea
--------------------------------	----------

B-Body Shifter Boots

Manual Transmission	
MP80102 1963-65 lower.....	164.99 ea
MP80103 1963-65 upper, w/console.....	179.99 ea
MP88104 1963-65 upper, w/o console.....	164.99 ea
MP88100 1966-68 w/A383 shifter.....	49.99 ea
MB561 1966-69 upper, w/console.....	74.99 ea

E-Body Shifter Boot Bezel

MD4009 1970-74 w/o console.....	19.99 ea
---------------------------------	----------

B-Body Shifter Boots - Continued

Manual Trans w/Hurst Pistol Grip	
MB560 1970 lower, w/console....	84.99 ea
MB562 1970 upper, w/console....	84.99 ea
MD4007 1971-74 upper, w/console....	41.99 ea
MD4008 1971-72 w/o console.....	44.99 ea
Automatic Transmission	
MD4006 1966-74 lower, with console....	31.99 ea

B-Body Shifter Boot Bezel

Manual Transmission with Hurst Pistol Grip Shifter	
MB761 1967-69 w/o console.....	19.99 ea
MD4009* 1971-72 w/o console.....	19.99 ea

E-Body Shifter Boots

Manual Transmission with Hurst Pistol Grip Shifter	
MD4007 1970-74 upper, w/console....	41.99 ea
MD4008 1970-74 w/o console.....	44.99 ea
Automatic Transmission	
MD4006 1970-74 lower, w/console....	31.99 ea

E-Body Shifter Boot Bezel

Manual Transmission with Hurst Pistol Grip Shifter	
MD4009 1970-74 w/o console.....	19.99 ea



Super Boot & Plate

Designed for large hole shifter installations, the Hurst Super Boot & Plate measures 7-3/4" x 8-3/4". Includes boot, chrome ID plate and mounting hardware. For Competition Plus shifters.

Note: No further discounts apply.

1147494 Super Boot & Plate.....	54.99 ea
---------------------------------	----------



MA2331



ME1005

1968-74 Shifter Rod Set

Replacement shifter rod sets for 1968-74 A, B, and E-Body vehicles. Each set includes the rods and ends for an exact replacement.

MA2331 1968-72 A-Body.....	94.99 set
MB2457 1968-70 B-Body.....	94.99 set
MB2458 1971-74 B-Body.....	94.99 set
ME1005 1970-72 E-Body.....	124.99 set
ME1006 1973-74 E-Body.....	114.99 set

Batteries and Battery Trays



MD2470



MD2470 top view



MD2470 front view



MD2467



MD2468



MD2450B



MD2450A



1962-74 Battery Trays

Factory-style replacement battery trays for 1962-74 models. Your choice of a Mopar officially licensed "Restorers Choice" panel, manufactured in OE-gauge steel featuring all original contours and details or our standard replacement for the car builder on a budget. Each tray comes finished in black EDP coating to prevent rust and ready to prep and paint to your desired color.

Restorers Choice

A-Body	MA2265	1963-66	battery tray	39.99 ea
	MA2266B	1967-74	battery tray	24.99 ea
B-Body	MB2386	1962-65	includes brace	39.99 ea
	MB2387	1966-69	battery tray	24.99 ea
	MD2450B	1970-72	battery tray	26.99 ea
	MB2388B	1973-74	battery tray	29.99 ea
E-Body	MD2450B	1970-74	battery tray	26.99 ea

Standard Replacement

A-Body	MA2266A	1967-74	battery tray	19.99 ea
B-Body	MD2450A	1970-72	battery tray	19.99 ea
	MB2388A	1973-74	battery tray	24.99 ea
E-Body	MD2450A	1970-74	battery tray	19.99 ea



1965-74 Reproduction AGM Maintenance Free Batteries

Reproduction AGM series batteries for various 1965-74 Dodge and Plymouth models. These reproduction batteries offer you enhanced performance and reliability while maintaining an authentic vintage appearance. AGM series batteries come fully charged and ready for installation. Features an incorporated valve regulated design that pressurizes the battery to keep it from drying out while the Absorbent Gas Mat separators eliminate gassing and leaking even if the case is broken. Correct markings and lettering are specific to each battery group, along with the correctly colored top caps. Officially licensed by Mopar and made in the USA.

Note: Shipped overweight.

Top Post Yellow Cap Batteries

MD2467	1965-74	10" x 6-5/8" x 9"	group 24	550 CCA	Maintenance Free	329.99 ea
MD2468	1965-74	10" x 6-5/8" x 9"	group 24	550 CCA	Maintenance Free	329.99 ea

Top Post Red Cap Batteries

MD2470	1965-74	12" x 6-3/4" x 9"	group 27	775 CCA	Maintenance Free	329.99 ea
--------	---------	-------------------	----------	---------	------------------	-----------



Optima Red Top Batteries

The OPTIMA RedTop high-performance AGM battery is the ultimate high-CCA starting battery designed to deliver the strongest 5-second ignition power for a reliable start-up every time. The RedTop outperforms and outlasts traditional batteries in demanding cranking/starting applications. With ultimate power delivery and durability, the RedTop is ideal for luxury cars, hot rods, off-road vehicles and other applications that require a leak-proof starting battery.

BY13001	800 CCA	Group 34/78	179.99 ea
BY13002	720 CCA	Group 25	169.99 ea
BY13003	720 CCA	Group 35	169.99 ea
BY13004	720 CCA	Group 37/25	169.99 ea



Optima Yellow Top Batteries

With premium cranking power, low internal resistance, and unparalleled cycling capability (rechargeability), the YellowTop AGM battery is a true dual-purpose automotive battery. It handles deep power drains and recharges to full capacity so it can power plenty of electronics and still start the engine time after time. Perfect for vehicles with multiple electronic systems or high demand audio.

BY13005	620 CCA	Group 35	204.99 ea
BY13006	620 CCA	Group 75/25	205.99 ea
BY13007	750 CCA	Group 34/78	214.99 ea
BY13008	450 CCA	Group 51	179.99 ea
BY13009	450 CCA	Group 51R	179.99 ea

OE AUTHORIZED



2208591

MD2456

1963-76 Battery Tray Braces

Battery tray braces for various 1963-76 Dodge and Plymouth models. Manufactured to original specifications and dipped in corrosion resistant primer. Includes correct 1-nut and mounting bolt.

A-Body	2208591	1963-66	2 required	12.99 ea
	MA2267	1967-76	1 required	12.99 ea
B-Body	MD2456	1966	2 required	12.99 ea
	MD2457	1966-69	1 required	12.99 ea
	MD2458	1967-69	2 required	12.99 ea
	MD2458	1970	1 required	12.99 ea
	MD2456	1971-72	1 required	12.99 ea
E-Body	MD2456	1970-74	1 required	12.99 ea

Battery Components

Billet Battery Box for Optima 34 Series Batteries

Finally, a battery box that looks as good as an Optima battery performs. Perfect for trunk mount applications.

Featuring polished aluminum hold down studs and stainless steel fasteners, this battery box will give you a reason not to hide that

Optima battery! Includes pre-drilled 5/16" holes in the base for mounting (hardware not included). Fits only genuine Optima 34 series batteries and measures 10" x 6.8" x 7.8". Battery not included. Made in USA.

BB700101	gloss black	95.99 ea
BB700102	matte black	95.99 ea
BB700103	polished	95.99 ea
BB700104	red	95.99 ea
BB700105	blue	95.99 ea



BB700104



Made in USA

Billet Battery Box for Optima 51 Series Batteries

Show off that Optima battery with one of these beautifully CNC machined battery boxes.

Perfect for trunk mount applications.

Designed only to house genuine Optima 51 series batteries, this battery box is available

in both full-cover and strap style and in a variety of finishes to suit your taste. Includes pre-drilled 5/16" holes in base for mounting (hardware not included). Battery not included. Made in USA.

Full Cover		
BB700111	gloss black	89.99 ea
BB700112	matte black	89.99 ea
BB700113	polished	89.99 ea
BB700114	red	89.99 ea
BB700115	blue	89.99 ea

Strap Style		
BB700121	gloss black	59.99 ea
BB700122	matte black	59.99 ea
BB700123	polished	59.99 ea
BB700124	red	59.99 ea
BB700125	blue	59.99 ea



BB700113



Made in USA



FB1301A

Fesher Billet Optima Battery Boxes

Add a finished look to your battery relocation or put a custom touch to your engine bay with these billet Optima battery boxes. Designed to fit all Optima battery models 34 and 34/78. Includes mounting hardware. Made in USA.

FB11301A	black anodized	179.99 ea
FB11301B	natural	149.99 ea
FB11301C	polished	199.99 ea



MD2452

MD2454

1960-76 Battery Tray Clamp

Battery tray clamps for various 1960-76 Dodge and Plymouth models. Replace your damaged or missing original clamp with a new one that features correct thermo-plastic coating as original.

MD2452	1960-65	all vehicles	16.99 ea
MD2453	1966-69	all vehicles	16.99 ea
MD2454	1970-76	A-Body	16.99 ea
MD2454	1970-71	B & E-Body	16.99 ea
MD2455	1972-74	B & E-Body	16.99 ea

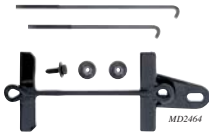

MD2464

1960-76 Battery Hold Down Sets

Battery mounting hardware for various 1960-76 Dodge and Plymouth models. Replace your damaged or missing components with one of these new sets. Each set includes all necessary hardware to secure the battery to the tray.

MD2461	1960-65	all vehicles	21.99 set
MD2462	1966-69	all vehicles	21.99 set
MD2463	1970-76	A-Body	21.99 set
MD2463	1970-71	B & E-Body	21.99 set
MD2464	1972-74	B & E-Body	21.99 set

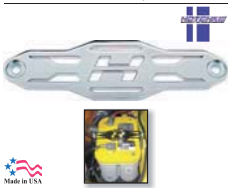

Made in USA

1968-74 Optima Battery Hold Down Plate

This great looking CNC machined aluminum hold down is designed to secure an Optima Battery. Features the Hotchkis flying "H" logo and a bright nickel finish that will make your Optima Battery stand out and your engine compartment gleam.

Note: No further discounts apply.			
H1761	1966-70	B-Body	74.99 ea
H1761	1970-74	E-Body	74.99 ea



Made in USA



1968-70 Upper Battery Cable Bracket

This bracket holds the positive battery cable to the left inner fender well of 1966-1970 B-Body vehicles. Manufactured from stainless steel with proper thermo-plastic coating. Includes mounting screw. Made in USA.

MB2390	1966-70	upper bracket	11.99 ea
--------	---------	---------------	----------



Made in USA



MB2389

MD2451

1968-74 Lower Battery Cable Bracket

This bracket holds the positive battery cable to the left frame rail on 1966-1974 B-Body and 1970-74 E-Body vehicles. Manufactured from stainless steel, with correct thermo-plastic coating. Includes mounting screw. Made in USA.

MB2389	1966-70	B-Body	12.99 ea
MD2451	1971-74	B-Body	15.99 ea
MD2451	1970-74	E-Body	15.99 ea



Made in USA

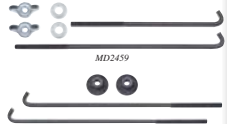

MD2459

MD2460

1968-74 Battery J-Bolt Sets

Battery mount J-bolt sets for various 1960-74 Dodge and Plymouth models. Features correct finish and each set includes two J-bolts and two correct style nuts. Made in USA.

MD2459	1964-69	all models	6.99 set
MD2460	1970-74	all models	7.99 set



Made in USA



1964-68 Rear Mount Battery Tray

Rear mount battery box for 1964-65 Max Wedge/Hemi B-Body models and 1968 Hemi S/S A-Body models. Manufactured in black rubber as original. Made in USA.

MD2120	1964-68	battery box	54.99 ea
--------	---------	-------------	----------

Battery Cables



1963-74 Battery Cables

Replacement battery cables for various 1963-74 Dodge and Plymouth models. Our cables feature correct lead length. We offer both styles of negative terminal heads for 1963-69 big and small block models. In addition, the positive cable assemblies are manufactured like original and include all additional wires necessary for each vehicle. Made in USA.

Positive Cables

A-Body				
MA2385	1967-68	small block	w/split starter lug/heat sheath.....	139.99 ea
MA2386	1968-69	big block	w/split starter lug/heat sheath.....	139.99 ea
MA2387	1969-72	small block	w/molded starter lug/heat sheath.....	139.99 ea
MD2570	1971-74	6-cylinder	all.....	126.99 ea
B-Body				
MB2529	1966-67	small block	w/split starter lug/heat sheath.....	139.99 ea
MB2530	1966-67	big block	w/split starter lug/heat sheath.....	139.99 ea
MB2531	1968	small block	with split starter lug.....	124.99 ea
MB2532	1968	big block	with split starter lug.....	124.99 ea
MB2533	1969-70	small block	w/1-piece molded starter lug.....	129.99 ea
MB2534	1969-70	big block	w/1-piece molded starter lug.....	129.99 ea
MD2570	1971-72	6-cylinder	all.....	126.99 ea
MD2535	1971-72	small block	all.....	124.99 ea
MD2570	1971-72	big block	all.....	126.99 ea
E-Body				
MD2570	1970-71	6-cylinder	all.....	126.99 ea
MD2570	1970-71	big block	all.....	126.99 ea
MD2570	1972	6-cylinder	all.....	126.99 ea
ME1698	1970-74	small block	340 6 bbl.....	144.99 ea

Negative Cables

MD2563	1963-69	small block	19" w/square head.....	69.99 ea
MD2564	1963-69	small block	19" w/round head.....	69.99 ea
MD2565	1963-69	big block	23" w/ square head.....	69.99 ea
MD2566	1963-69	big block	23" w/round head.....	69.99 ea
MD2567	1963-69	big block	25" w/round head.....	69.99 ea
MD2568	1970-72	small block	19-1/2".....	74.99 ea
MD2569	1970-71	383	23-1/2" B & E-Body models.....	74.99 ea
MD2569	1970-71	440/440+6	23-1/2" B & E-Body models.....	74.99 ea
MD2569	1972	400/440	23-1/2" B-Body models.....	74.99 ea



Service Replacement Battery Cables

Having electrical issues? You may be shocked to realize that the problem may not be your battery or alternator, but rather your battery cables. Though these cables may not be cosmetically correct for your vehicle, they will fit and function correctly on a variety of applications. All cables are 4 gauge, stranded copper wire and are equipped with an accessory lead wire. Battery clamp bolt and nut are included.

Positive Battery Cables

Top Post			
N110	10"		9.99 ea
N112	12"		9.99 ea
N220	20"		11.99 ea
N325	25"		11.99 ea
N330	32"		12.99 ea
N338	37"		12.99 ea
N338	38"		12.99 ea
N343	42"		12.99 ea
N343	43"		12.99 ea
N153	48"		12.99 ea
N353	53"		14.99 ea
N356	54"		16.99 ea
N356	56"		16.99 ea
N365	65"		14.99 ea
N372	72"		18.99 ea
N378	78"		18.99 ea

Side Terminal

N530	30"		10.99 ea
N735R	35"		10.99 ea
N740	40"		14.99 ea
N545	45"		11.99 ea
N745	50"		16.99 ea
N555	55"		12.99 ea
N565	65"		13.99 ea
G7871	78"		13.99 ea

Negative Battery Cables

Top Post			
N210	10"		9.99 ea
N212	12"		9.99 ea
N215	15"		11.99 ea
N120	20"		11.99 ea
N425	25"		12.99 ea
N427	27"		12.99 ea
N130	32"		12.99 ea
N434	34"		13.99 ea
N438	38"		13.99 ea
N448	48"		13.99 ea
N456	56"		14.99 ea
N465	65"		14.99 ea
N472	72"		16.99 ea
N478	78"		16.99 ea

Side Terminal

N620	20"		9.99 ea
N725	25"		9.99 ea
N730	30"		10.99 ea
N735B	35"		10.99 ea
N740B	40"		14.99 ea
N645	45"		11.99 ea
N655	55"		12.99 ea
N665	65"		13.99 ea
N678	78"		14.99 ea

Battery Cables & Terminals

New!



Battery Terminal Protectors

Prevent corrosion build up on the battery terminals with these battery terminal protectors. Each color coded black and red protector is manufactured from chemically treated anti-corrosion polyester fiber.

W215007 protectors..... 1.99 pr



1963-69 Engine To Firewall Ground Cable

Engine to firewall ground cable for all 1963-69 Dodge and Plymouth models. Available in correct length for models both with and without air conditioning. Made in USA.

MD2571 1963-69 small block 16"..... 21.99 ea
 MD2572 1963-69 big block w/o AC 13"..... 21.99 ea
 MD2573 1963-69 big block/Hemi with AC 10"..... 21.99 ea



Replacement battery cables for various 1966-71 Dodge and Plymouth models. Features correct markings on terminals and includes correct bolt, nut and all additional wires when applicable. Made in the USA.

1966-71 Hemi Battery Cables

Positive Cables			
B-Body			
MB2520	1966	A/T.....	269.99 ea
MB2521	1966	M/T.....	269.99 ea
MB2522	1967	M/T.....	269.99 ea
MB2523	1967-68	A/T w/1-prong neutral safety switch.....	269.99 ea
MB2524	1968-69	A/T w/3-prong neutral safety switch.....	269.99 ea
MB2525	1968-69	Charger M/T.....	269.99 ea
MB2526	1968-69	all except Charger M/T.....	269.99 ea
MB2527	1970	A/T.....	269.99 ea
MB2528	1970	M/T.....	269.99 ea
MD2561	1971	A/T.....	284.99 ea
MD2562	1971	M/T.....	269.99 ea
E-Body			
MD2561	1970-71	A/T.....	284.99 ea
MD2562	1970-71	M/T.....	269.99 ea
Negative Cables			
B-Body			
MB2518	1966-67	all.....	69.99 ea
MB2518	1968	early models.....	69.99 ea
MB2519	1968	late models.....	69.99 ea
MD2560	1969	all.....	69.99 ea
MD2560	1970-71	all.....	74.99 ea
E-Body			
MD2560	1970-71	all.....	74.99 ea

New!



Battery Cable Adapters

Set of positive and negative side terminal adapters that enables you to convert side terminal style cables to be used with top post batteries without changing the cables or cable ends. Comes with 1 positive and 1 negative terminal adapter, 2 terminal bolts, and 2 terminal nuts.

500779 adapters..... 8.99 set



Battery Cable Terminals

Due to the corrosive nature of battery electrolyte, the original lead cast positive and negative terminal ends usually require replacement every few years. We offer these replacement style late model OEM type terminals for use on top post batteries.

10626 top post..... 2.99 ea
 SBT1 side post w/bolt..... 2.99 ea



1970-74 Battery Cable Strap

Reproduction battery cable strap for 1970-74 E-Body models. Mounts to the shock and restrains the battery cable. ME1699 1970-74..... 5.99 ea



1983-74 Battery Cable Bolt

Replacement battery cable bolt for all 1963-74 models. The terminal head is the rounded style, features correct markings and includes the correct bolt and nut. MD2574 1963-74 bolt..... 3.99 ea



Universal Battery Cables

Underhood or trunk-mount battery cable sets. Each cable is 1 gauge and features lead die cast top-post terminals with a steel ring insert. This feature prevents cracking or breaking the terminal due to tightening. Each version comes in either top-post or side-post sets. Trunk mount sets measure 18" while underhood sets measure 6" in length. Negative cables feature pre-assembled 36" long 6 gauge secondary lead. Each set includes crimping tool, extra lugs and shrink tubing.

Trunk Mount			
BC900710	top post.....	175.99	set
BC900702	side post.....	163.99	set
Underhood Mount			
BC900703	top post.....	115.99	set
BC900704	side post.....	104.99	set



Battery Switches

These high quality battery switches are ideal for use as a theft deterrent or preventing battery drain without removing the cables. They're easy to install on the negative battery post and disconnect the battery by simply loosening the knob a few turns. To reconnect just re-tighten the knob. The knob can be removed completely to deter theft. Rated at 500 amps surge and 125 continuous at 12 volts. Available with a 15 amp fused bypass that maintains computer settings, radio, clock etc. while the battery is disconnected.

W20307	side post	w/o fused bypass.....	16.99 ea
W20308	top post	w/o fused bypass.....	9.99 ea
W20309	top post	w/fused bypass.....	12.99 ea

Battery Accessories



Quick Release Battery Cable Bolts

These handy quick release bolts replace standard 5/16" battery clamp bolts used for most top batteries. The cam lever action tightens and loosens the bolts without tools. They're constructed from anti-corrosive stainless steel and padded with color coded red and black polypropylene.

W20251 top post 5/16" bolts 9.99 pr



Lifeline Memory Retention System

The Lifeline enables users of a Master Disconnect Switch to retain a small amount of power for memory circuits common in fuel injection computers, radio presets and clocks. The Lifeline is a memory circuit retainer that will automatically reset after the electrical load is significantly reduced or if the Master Disconnect Switch has been switched to the on position. Available for standard or remote battery disconnections.

500778 standard disconnect 27.99 ea
500837 remote disconnect 35.99 ea



Quick-Disconnect Battery Terminal

This brass, quick-disconnect battery terminal isolates the vehicle's battery, allowing the clock, radio etc. to remain functional when combined with a fused bypass. Designed for both round and square battery lugs.

W203507 9.99 ea

Battery Carrying Strap

This handy tool is a must for your tool box. Allows you to easily carry bulky automotive batteries without getting acid on your clothes and hands. Each end is marked and sized to fit the positive or negative terminals allowing a secure, tight fit onto the post. Battery acid won't harm the strap!

X205 carries top mount only 6.99 ea



Battery Cable Crimping Tool

No matter what the size of your battery cable job, this is the tool that will make quick work of it. By simply selecting the proper size to match your crimp and aligning the star with the battery lug in your vise, you will gain a professionally strong and conductive crimp every time!

500665 12.99 ea



Side Terminal Adapters

If you are converting a side terminal battery to top post cable usage, we offer this convenient kit which allows you to install and operate your replacement battery without unnecessary cutting of your cables.

RCP3L pos & neg 4.99 set



Easy Click Battery Cable Connectors

The Easy Click self-tightening battery connectors allow quick connection and disconnection of top post batteries. Manufactured from solid brass and tin plated to enhance conductivity and corrosion resistance. Includes snap on covers to prevent electrical shorts. Rated at 1000 amps maximum.

EC100201 24.99 pr

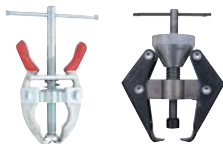

W210277

Y54000

Battery Terminal Puller

This handy tool is used to remove battery terminal clamps without damage to the battery posts. By simply placing the jaws of the puller under the battery cable clamp, tighten the screw until the clamp is removed.

Great for removing corroded battery terminals. Your choice of standard grade or professional level tool.
W210277 standard puller 8.99 ea
Y54000 professional level puller 24.99 ea



W203047



T4988

Battery Cutout Switch

Make sure your battery maintains the precious power you need by disconnecting the battery from the car during storage. Your choice of an inexpensive standard duty cutout or a heavy duty unit. Works on any 12 volt system or vehicle. Splices into positive battery cable to provide a switch for turning power on or off.
W203047 standard duty 24.99 ea
T4988 heavy duty 79.99 ea



Disconnect Position Ring

For use on disconnect switches to identify the correct position of the switch (ON or OFF). Eliminates the question of which direction is the safe one.

BC900705 4.99 ea



Battery Terminal Protector Boots

This red PVC terminal boot insulates terminals to prevent short circuits and help reduce corrosion.

NL10470 side post 6.99 ea



W20314

Water Resistant Master Switch

This water resistant master switch is rated to 100 amps continuous, 1,000 amps surge at 12 volts, and 50 amps surge at 24 volts. 2-1/4" dia. x 2-1/2" deep and 1-1/4" deep behind panel. Features two 3/16" dia. mounting holes. Includes 2 keys and a water resistant cover.
W20314 switch set 19.99 set
W203167 replacement key 2.99 ea
W203127 replacement cover 2.99 ea

Battery Accessories



Battery Post Cleaning Tools

This handy little device will help keep your battery posts clean and free of corrosion. Manufactured in your choice of high-impact plastic or heavy-duty steel. Won't corrode or soften in cleaning solutions. Includes external brush for cable clamps and an internal brush for battery terminal posts. This item is good to use whenever servicing the battery or cleaning the engine compartment.

X201	high-impact plastic	8.99 ea
X206	heavy-duty steel	9.99 ea
X2173	post and terminal tool	9.99 ea



Battery Terminal Spreader and Cleaner

Clean and spread battery cable terminals with this pliers type tool. Sharp teeth effectively clean corrosion from clamp. Squeeze handle to spread clamp.

X204		21.99 ea
------	--	----------

New!



Temperature Sending Wire Cloth Insulator

This 3/16" ID, 5/16" OD replacement cloth insulator, keeps your temperature sender harness well insulated from engine heat. Sold per foot. 2-3 feet required per vehicle.

K0163		1.50 ft
-------	--	---------



Battery Cable Cloth Insulator

Original style black cloth insulation for use with battery cables. 1/2" cloth insulation. Sold by the foot.

K0169	sold by the foot	1.99 ft
-------	------------------	---------

New!



130 Amp Heavy-Duty Battery Load Tester

Applying a powerful 130 amp load, this heavy-duty battery tester delivers more accurate results than conventional testers. Determine a battery's state of charge as well as cranking and charging volts. Large, easy-to-read display. Unique clamp design for side and top post batteries. Side clamp mount for cable storage. Convenient zero adjust to reset pointer. Lightweight, comfortable, easy-to-grip. Multi-mount bracket for easy storage on a wall or tool box.

AC7614		74.99 ea
--------	--	----------



Battery Nut Pliers

Easily loosen and tighten nuts on battery terminal clamps. Handles are offset for working in cramped areas. Serrated jaws are designed for sure grip.

X203		16.99 ea
------	--	----------



Side Terminal Battery Wrench

Make life easier with this reversible ratchet. Fits standard 5/16" side mount battery bolt.

W21020	5/16"	9.99 ea
--------	-------	---------



24 piece accessory connector kit

Accessory Connector Pack

Add power accessories without cutting or splicing. This 24 piece connector kit includes a variety of power tap and connector types to connect any power accessory. Includes 2 taps for ATO fuse blocks, 2 taps for ATM mini fuse blocks, 2 taps for AGS fuses, 2 taps for chassis or top post battery, 2 taps for chassis or side terminal battery, 4 red terminals for 18-22 gauge wire, 4 blue terminals for 14-16 gauge wire, 2 yellow terminals for 10-12 gauge wire, 2 top post accessory bolts, and 2 side terminal accessory bolts.

W30995	connector set	24 pieces	16.99 set
--------	---------------	-----------	-----------



Fuse Tap/Fuse Holders

You can now add circuits without cutting or splicing into your wire harness with this Tap-a-Circuit fuse holder. These will work with ATO and mini blade style fuses. This is a fast and easy way to add additional accessories such as CD players, car phones, radar detectors, 2-way radios and more.

Note: Accessory must not exceed 10 amps.

14490	for ATO fuses	9.99 ea
14491	for mini fuses	9.99 ea



Battery Lifesaver - Corrosion Remover

Lead acid batteries will discharge, deteriorate and die without regular use or recharging because of corrosion and sulfates on the plates. This module, developed specifically for vehicles that are not driven on a regular basis to keep their battery fully charged, will actually recover lost battery capacity by removing plate corrosion, and in turn, extend battery life up to double or triple the normal life span!

BSL1		29.99 ea
------	--	----------

Battery Mat - Acid Neutralizer

The Battery Mat offers protection against undetected battery acid leaks. Once installed, the mat will trap and neutralize any battery acid that leaks from the terminals or top side of the battery, preventing corrosion and expensive damage. Each mat is made of super absorbent polypropylene needle punch felt, with one side heat treated to give it additional strength. The mat is inserted under the battery between the battery and the battery tray. It can easily be installed at any time either when replacing the battery tray or battery.

BM2427	yellow mat	4.99 ea
BM2428	black mat	4.99 ea

Battery Chargers and Tenders



W20043

W20039

The Battery Doc Sport Charger

The Battery Doc Sport Charger is a compact battery charging system that charges and maintains batteries from 5-200 amp hrs and can maintain a battery up to 400 amp hrs. This is a 12 volt, 1.25 amp, 3 stage charger that can be left on your battery indefinitely without concern of overcharge. Includes the 1.25 amp charger with 6' input and output lead cables, 3 color LED charge indicator, battery clamp connector, terminal ring connector with in-line fuse, cigarette lighter adapter and carrying bag.

Complete Charger Set

W20039 The Battery Doc, 5 piece set..... 39.99 set

Individual Replacement Components

W20043 battery clamp connector..... 9.99 ea
W20049 terminal ring connector..... 6.99 ea
W20045 cigarette lighter adapter..... 12.99 ea
W20047 carrying bag..... 9.99 ea



The Battery Tender Junior

The Battery Tender Junior is a 12 volt, .75 amp battery charger that is designed to fully charge and maintain a battery at a proper storage voltage without the damaging effects caused by trickle chargers. The Battery Tender Junior is ideal for those hard to fit spots. Your battery will be ready to go when you are! Includes ring terminals and alligator clips.

21023 The Battery Tender Junior..... 29.99 ea



220165

220148

Multiple Battery Management Systems

Great for multiple battery upkeep, these are 12 volt, 1.25 amp, 4 step battery charging systems that feature short circuit protection and are spark proof. The 2 bank model will keep up to two batteries charged, the 4 bank will keep up to four batteries charged and ready to go. Can be used as a portable unit or permanent mount. Your battery will be ready to go when you are! Includes ring terminals and alligator clips.

220165 2 bank..... 99.99 ea
220148 4 bank..... 209.99 ea



W20030

Battery Doc Wall Mount Battery Charger

The Battery Doc Wall Mount I is a 1 amp charging system that charges and maintains batteries from 5-100 amp hrs and can maintain a battery up to 200 amp hrs. The Wall Mount II is a 2 amp unit that charges and maintains batteries from 5-200 amp hrs and can maintain a battery up to 400 amp hrs. These chargers can be left on your battery indefinitely without concern of overcharge. Includes 12' output lead cable, 3 color LED charge indicator, battery clamp connector, terminal ring connector with in-line fuse, cigarette lighter adapter and carrying bag.

Complete Charger Sets

W20030 Wall Mount I 1 amp..... 32.99 set

W20033 Wall Mount II 2 amp..... 37.99 set

Individual Replacement Components

W20043 battery clamps..... 9.99 ea
W20049 terminal ring connectors..... 6.99 ea
W20045 cigarette lighter adapter..... 12.99 ea
W20047 carrying case..... 9.99 ea



Battery Doc Battery Tester

To test your battery, simply attach the ring terminals of the battery tester connector directly onto your battery and push the button. The tester will indicate if your battery is weak or fully charged. If your battery needs charging, simply attach the Battery Doc Charger (available separately) to the connector and juice it up!

W20040 battery tester..... 12.99 ea



The Battery Tender Plus

The Battery Tender Plus is a 12 volt, 1.25 amp battery charger that is designed to fully charge and maintain a battery at a proper storage voltage without the damaging effects caused by trickle chargers. The micro-chip technology applies the correct peak charge, then automatically maintains the battery at the perfect float voltage. The Battery Tender Plus will correctly charge and maintain any type of lead acid, AGM, sealed calcium or gel batteries. Your battery will be ready to go when you are! Includes ring terminals and alligator clips.

21028 The Battery Tender Plus..... 49.99 ea



PriorityStart! Battery Protector

The PriorityStart! 12-Volt ProMax has a surge "spike" protection circuit that adds additional protection to the electrical system. Transient voltage "spikes" can cause damage to computers, 2-way radios, MDT equipment, cameras, and a host of other electrical equipment. The ProMax can be used on all 12-Volt vehicles including those with such after-market accessories.

PS1002..... 99.99 ea

Wiring Accessories



Accessory Wire

Create custom wiring harnesses yourself, to your own particular specifications! Coils of 12, 14, 16, and 18 gauge wire in 25 foot increments are available for installers to make wiring their power accessories much easier than ever before. This wiring is well marked for location source, featuring the clearest wire printing in the industry.

12 Gauge Wire x 25' Coil	
500809	yellow power window..... 19.99 ea
500810	red power locks..... 19.99 ea
500815	orange power seats..... 19.99 ea
500820	brown heat and AC feed..... 19.99 ea
500831	black ground..... 19.99 ea
14 Gauge Wire x 25' Coil	
500807	red audio-video feed..... 14.99 ea
500808	white power antenna..... 14.99 ea
500811	orange alarm feed..... 14.99 ea
500813	dk blue power trunk..... 14.99 ea
500814	pink door solenoid..... 14.99 ea
500821	tan fuel pump..... 14.99 ea
500830	black ground..... 14.99 ea
16 Gauge Wire x 25' Coil	
500817	yellow radio battery..... 11.99 ea
500819	tan radio..... 12.99 ea
18 Gauge Wire x 25' Coil	
500812	orange cell phone feed..... 11.99 ea
500816	pink back-up feed..... 12.99 ea
500818	yellow clock battery..... 12.99 ea
500822	lt. green back-up..... 12.99 ea
500823	tan electric choke..... 12.99 ea
500829	black ground..... 12.99 ea



Light-Up Smart Fuses

These are blade style "Smart" fuses that light up when the circuit overloads and the fuse breaks. The 5 piece sets contain (1) 10 amp, (1) 15 amp, (1) 20 amp, (1) 25 amp and (1) 30 amp fuse. The 10 piece sets contain 2 each of the fuses listed above. Keep a set in your glove compartment!

244001	ATO	5 pack..... 7.99 set
244031	ATO	10 pack..... 14.99 set
241001	mini	5 pack..... 7.99 set
241031	mini	10 pack..... 15.99 set



Wiring Harness Tape

If you want an OEM quality and appearance for your original or reproduction wiring, this specially manufactured black, non-stick tape is what you need! This tape will allow you to rewrap your existing harness or replace tape which may have been removed.

K0067	1-1/4 x 100' vinyl..... 11.99 ea
CA4857	1" x 100' cloth..... 16.99 ea



XT100



XT101

X-Treme Tape

X-Treme Tape was developed for the military and has some very unusual properties. The silicone-based tape will stick only to itself, and only when placed under tension. Once wrapped around an object, it forms a non-conductive, air and water-tight, insulating seal that remains flexible within a temperature range of -60° to 500°F. Insulates to 8000 volts. Stretches to 3 times its length. Conforms to irregular shapes. When wrapped upon itself, it bonds together immediately and becomes completely fused after 24 hours at room temperature.

XT100	black	10'..... 6.99 ea
XT101	red	10'..... 6.99 ea
XT102	grey	10'..... 6.99 ea
XT103	white	10'..... 6.99 ea



Relay Puller Pliers

Pliers for removing electrical relays on most domestic and import vehicles. Offset handle and thin tips allow access to relays in confined areas. Specially designed tips are angled to fit slots or edge of relay cover.

46950 21.99 ea
-------	----------------



High Low Voltage Tester

Checks 6 volt and 12 volt circuits for voltage and spark plugs for spark. Ground clip and touch probe to point being tested. Tester bulb will light if power is present.

X126 12.99 ea
------	----------------



Short Circuit Detector

Locates short circuits in 6 and 12 volt systems right through upholstery, body panels, and metal door posts. All the hard to get to and crucial areas. Connect the tester across the burned out fuse, move meter along wire route and the meter needle will oscillate until the short is found.

X2524 34.99 ea
-------	----------------



Deluxe Low Voltage Circuit Tester

Tests for voltage in 6 and 12 volt systems. This tester is useful for headlamps, taillights, turn signals, faulty sockets, connections, fuses and broken wires. Helps eliminate precious time when trying to figure out the problem. Includes a tough, durable and shock resistant case.

X2646 9.99 ea
-------	---------------



Circuit Continuity Tester

Safely tests circuits with power off. Ideal for testing fuses, grounds, shorts, contacts, diodes and open circuits. Designed specifically for the home mechanic. Includes 36" cable. AA battery required (not included).

X2647 9.99 ea
-------	---------------



Electrical Connector Separator

Quickly disconnect multi-wire and weatherpack style connectors without damage to the wires or connector.

Y1320	electrical connector separator..... 11.99 ea
-------	--

Wiring Components



1965-76 Original Style Wiring Terminals

Original style wiring terminals for 1965-76 models. Wiring terminals which often are affected by engine heat, chemicals and weather need to be replaced. These terminals are ideal for use when the wiring is good but the terminal needs to be replaced.

Ballast Resistor Terminal

MD4500 1972-76 dual prong ballast resistor 7.99 ea

Engine Wiring Terminal

MD4501 to 1969 8-prong black..... 11.99 ea

MD4502 1971-up B-Body 8-prong white... 11.99 ea

MD4503 1970-up E-Body 8-prong white... 11.99 ea

Neutral Safety Switch Terminal

MD4504 1971-up B-Body 4-prong white... 11.99 ea

MD4504 1971-up E-Body 4-prong white... 11.99 ea

Early Headlamp and Wiper Wiring

MD4505 1965-67 A-Body..... 11.99 ea

MD4505 1965-67 B-Body..... 11.99 ea

MD4505 1965-67 B-Body..... 11.99 ea

MD4505 1965-67 B-Body..... 11.99 ea

MD4505 1965-67 B-Body..... 11.99 ea

MD4505 1965-67 B-Body..... 11.99 ea

MD4505 1965-67 B-Body..... 11.99 ea

MD4505 1965-67 B-Body..... 11.99 ea

MD4505 1965-67 B-Body..... 11.99 ea

MD4505 1965-67 B-Body..... 11.99 ea

MD4505 1965-67 B-Body..... 11.99 ea

MD4505 1965-67 B-Body..... 11.99 ea

MD4505 1965-67 B-Body..... 11.99 ea

MD4505 1965-67 B-Body..... 11.99 ea

MD4505 1965-67 B-Body..... 11.99 ea

MD4505 1965-67 B-Body..... 11.99 ea

MD4505 1965-67 B-Body..... 11.99 ea

MD4505 1965-67 B-Body..... 11.99 ea

MD4505 1965-67 B-Body..... 11.99 ea

MD4505 1965-67 B-Body..... 11.99 ea

MD4505 1965-67 B-Body..... 11.99 ea

MD4505 1965-67 B-Body..... 11.99 ea

MD4505 1965-67 B-Body..... 11.99 ea

MD4505 1965-67 B-Body..... 11.99 ea

MD4505 1965-67 B-Body..... 11.99 ea

MD4505 1965-67 B-Body..... 11.99 ea

MD4505 1965-67 B-Body..... 11.99 ea

MD4505 1965-67 B-Body..... 11.99 ea

MD4505 1965-67 B-Body..... 11.99 ea

MD4505 1965-67 B-Body..... 11.99 ea

MD4505 1965-67 B-Body..... 11.99 ea

MD4505 1965-67 B-Body..... 11.99 ea

MD4505 1965-67 B-Body..... 11.99 ea

MD4505 1965-67 B-Body..... 11.99 ea

MD4505 1965-67 B-Body..... 11.99 ea

MD4505 1965-67 B-Body..... 11.99 ea

MD4505 1965-67 B-Body..... 11.99 ea

MD4505 1965-67 B-Body..... 11.99 ea

MD4505 1965-67 B-Body..... 11.99 ea

MD4505 1965-67 B-Body..... 11.99 ea

MD4505 1965-67 B-Body..... 11.99 ea

MD4505 1965-67 B-Body..... 11.99 ea

MD4505 1965-67 B-Body..... 11.99 ea

MD4505 1965-67 B-Body..... 11.99 ea

MD4505 1965-67 B-Body..... 11.99 ea

MD4505 1965-67 B-Body..... 11.99 ea

MD4505 1965-67 B-Body..... 11.99 ea

MD4505 1965-67 B-Body..... 11.99 ea



Bulkhead Connector Gasket/Clip Set

OE style replacement electrical bulkhead connector to firewall seals for 1964-70 A and B-Body vehicles.

MD6411 1964	A, B-Body.....	9.99 ea
MD6412 1965-70	A, B-Body.....	11.99 ea



MD7121

MD7122

Made in USA

1960-76 Neutral Safety Wire Harness Clips

Replacement wire harness retaining clips for all 1960-76 models. These clips are used to secure the reverse light/neutral safety wire harness as it passes from the firewall bulk head connector to the transmission switch. Part number MD7121 is commonly found under the upper left bell housing-to-block mounting bolt of both AT and MT transmission applications. Part number MD7122 is located under either of the upper tail shaft mounting bolts for automatic applications. Made in USA.

MD7121 1960-76	all models.....	9.99 ea
MD7122 1960-76	all models.....	9.99 ea



1967-76 Brake Switch Wire Retaining Clip

Wire retaining clip for the brake system indicator switch wire on 1967-76 A-Body models. Mounts to the left inner fender on the rear of the shock tower. Features zinc plating, correct gauge steel and thermo-plastic coated for proper appearance. Mounting screw is included. Made in USA.

MA2474 1967-76	A-Body.....	6.99 ea
----------------	-------------	---------



MB1721

MB1722

Made in USA

1966-70 B-Body Firewall Wiring Bracket

Replacement wiring bracket for all 1966-70 B-Body models equipped with manual or power brakes. Available in long or short versions and mounts on the brake pedal reinforcement bracket. Manufactured from correct gauge galvanized material and thermo-plastic coated for an original appearance. Made in USA.

MB1721 1966-70	long version.....	24.99 ea
MB1722 1966-70	short version.....	24.99 ea



1970-74 Firewall Wiring Bracket Set

Replacement firewall wiring bracket for 1971-72 B-Body and 1970-74 E-Body models. These brackets mount on the brake pedal reinforcement bracket behind the master cylinder on all manual brake vehicles, and on the rear of the power brake booster on Hemi power brake applications. Manufactured from correct gauge material and thermo-plastic coated for original appearance. Correct mounting hardware is included. Made in USA.

MD1628 1970-74	B, E-Body.....	34.99 set
----------------	----------------	-----------



MD6416

1966-76 Transmission Harness Pigtails

These pigtails include the socket and 12" of wire to splice into existing harness.

MD6416 1966-76	manual trans, 2 prong	35.99 ea
MD6417 1968-76	auto trans, 3 prong.....	29.99 ea



1970-74 Brake Booster Wiring Clip

Replacement wiring harness clip that mounts to the left side power brake booster studs on non-Hemi 1971-74 B-Body and 1970-74 E-Body models. Manufactured from correct gauge material with zinc plated clamp fingers, and thermo-plastic coated for an original appearance. Mounting hardware is included. For 18-14 gauge wire. Made in USA.

Important: This piece was originally painted black with the booster assembly on 1970 E-Body models, and left natural for all other applications.

MD1629 1970-74	B, E-Body.....	29.99 ea
----------------	----------------	----------

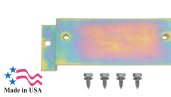

Made in USA

1971-76 ECU Mounting Bracket

Replacement ECU mounting bracket for all 1971-76 models. Manufactured from correct heavy gauge steel and zinc dichromate plated for an original appearance. This piece allows the ECU to be mounted on the firewall or inner fender. Mounting hardware is included. Made in USA.

MD4698 1971-76	all models.....	31.99 ea
----------------	-----------------	----------

New!



1963-69 Turn Signal Switch Connector

Replacement turn signal switch connector for 1963-69 Mopar models. Manufactured to factory specifications, this connector will replace the old broken and deteriorated connector. Includes the mounting anchor.

MN3254 1963-69	9.99 ea
----------------	-------	---------

Wiring Components



WC500115

Universal Metal Blades & Connectors

Universal metal blades and connectors for various wiring applications. Each set includes 10 pieces. For 18-14 gauge wire.

56 Series Connectors

WC500114 female, .250 terminal 4.99 set

WC500115 male, .250 blade 4.99 set

59 Series Connectors

WC500116 female, .320 terminal 4.99 set



500179

500181

500182

500180

Universal Wire Grommets

Universal wire grommets for routing wire through the firewall. In addition to the added protection, these grommets also give the hole in the firewall a cleaner appearance. Measured in inner diameter and outer diameter. Outer diameter refers to the hole needed in the firewall or other body panel.

Note: *Can be drilled out up to 1/4" opening.

500179 1/2" o.d. 16ga. i.d. 4.99 ea

500181 3/4" o.d. no opening 4.99 ea

500182 7/8" o.d. 7/16" i.d. 4.99 ea

500183 1" o.d. 10ga. i.d. 4.99 ea

500185 1-1/4" o.d. 7/32" i.d. 6.99 ea

500186 1-1/2" o.d. 15/32" i.d. 4.99 ea

500187 1-3/4" o.d. 7/16" i.d. 8.99 ea

500180 3/4" o.d. 12ga. i.d. 4.99 ea



Semi-Rigid Wrappable Split Braided Tube

Clean up and protect any wiring harness with this braided wire wrap. The semi-rigid tube opens along a lateral split to accommodate a variety of harness configurations, then simply closes without any need for fasteners. A 25% overlap ensures complete coverage. Retains shape and rigidity from -94° to 257° F. Available in black only. For 18-14 gauge wire.

71901 1/8" diameter 25 ft length 11.99 ea

71902 1/4" diameter 20 ft length 14.99 ea

71903 3/8" diameter 15 ft length 15.99 ea

71904 1/2" diameter 10 ft length 15.99 ea

71905 3/4" diameter 8 ft length 16.99 ea

71906 1" diameter 8 ft length 18.99 ea

71907 1-1/4" diameter 4 ft length 17.99 ea

71908 1-1/2" diameter 4 ft length 17.99 ea

71909 2" diameter 4 ft length 18.99 ea



Shrinkflex Fabric Heatshrink Tubing

Shrinkflex fabric tubing is the only product of its kind. The unique weave of Polyolefin and Polyester easily installs over wiring harness bundles, connectors and splices, as well as rubber hoses and plastic pipes. When heated to 176°, it shrinks to 1/2 the original diameter while remaining flexible, even at high temperatures!

HT719301 1/2" x 12' 19.99 ea

HT719302 3/4" x 10' 19.99 ea

HT719303 1-3/16" x 8' 19.99 ea

HT719304 1-1/2" x 6' 19.99 ea

HT719305 2" x 6' 19.99 ea

HT719306 2-3/8" x 6' 19.99 ea

HT719307 2-3/4" x 6' 23.99 ea



WC500103

WC500104

WC500105

WC500106

Universal Wire Connector Plastic Ends

OE style connectors for various wiring applications. For 18-14 gauge wire.

Female Connectors

WC500101 flat two-way 4.99 ea

WC500102 two-way 3.99 ea

WC500103 1-way 3.99 ea

WC500104 3-way 4.99 ea

WC500105 two-way sealed beam 4.99 ea

WC500106 3 way sealed beam 4.99 ea



ME1699

MN1215

MN1782

MN1824

Individual Wiring Straps and Clips

Clean up the wiring in your engine compartment with these replacement wiring strap and fasteners.

Wiring Straps

MN1209 5" clear 9.99 ea

MN1210 5" antique 4.99 ea

MN1216 3 1/2" antique 9.99 ea

MN1217 3 1/2" antique 4.99 ea

ME1699 1970-74 E-Body 5.99 ea

Wiring Clips

MN1215 1963-66 A-Body 4.99 ea

MN1215 1966-70 A & B-Body 4.99 ea

MN1782 1970 E-Body, U shaped 5.99 ea

MN1824 1971-74 B & E-Body, round 2.99 ea

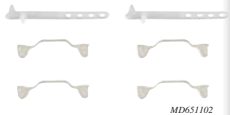

MD651102



MN1208

1963-74 Engine Bay Wiring Strap & Fastener Sets

Clean up the wiring in your engine compartment. These replacement wiring strap and fastener sets includes all of the original type fasteners and clips. All straps have the correct fit and finish.

A-Body Models

MD651101 1963-66 10.99 set

MD651102 1967-69 8.99 set

MN1781 1970-74 8.99 set

B-Body Models

MD651104 1964-65 8.99 set

MN1779 1966-70 11.99 set

MN1780 1971-72 16.99 set

MD651107 1973-74 6.99 set

E-Body Models

MN1206 1970 18.99 set

MN1780 1971-74 16.99 set



MN1214

1964-74 Antique Look Engine Wiring Strap & Fastener Sets

Clean up the wiring in your engine compartment with these replacement wiring strap and fastener sets. Each set includes all original type fasteners and clips and all straps have the correct fit and antique finish for an authentic appearance.

MN1211 1967-69 A-Body 11.99 set

MN1212 1964-65 B-Body 14.99 set

MN1783 1966-70 B-Body 15.99 set

MN1213 1973-74 B-Body 9.99 set

MN1214 1970 E-Body 20.99 set

Wiring Harnesses

1970-74 E-Body Classic Update Wiring Harness For Resto-Custom Cars!

Classic  Update



Steering column connectors can plug directly into most aftermarket steering columns or stock 1970-74 Mopar columns.

Engine wiring includes connectors for original points type distributors, OEM Chrysler style starter relay connections and ignition leads.

Front lighting includes extra long leads that can be routed as original. All light terminals included.

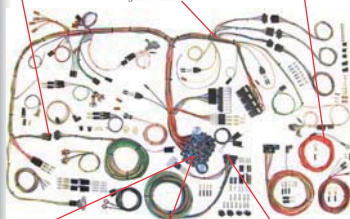

New ATO Fuse panel allows for easy fuse and circuit breaker accessibility. Original switch connector bodies are included on all wiring.

Fuse panel designed to mount in original location. Standard turn signal and flasher relays are mounted on fuse panel.

System will connect into most popular aftermarket gauges such as Autometer, Classic Instruments, Stewart Warner, VDO, etc.

1970-74 E-Body Classic Update Wiring Harness

Classic Update wiring harness for 1970-74 E-Body models. These complete-car wiring harness systems not only allow you to power your essentials, but also add accessories such as air conditioning or power windows. The main harness includes turn signal and hazard flashers mounted on the ATO style fuse panel, which installs in the factory location (minor firewall modification required), original switch connector bodies, steering column connector, under dash courtesy lamps, an instrument cluster harness disconnect, a rear body harness, and a new floor-mounted dimmer switch. A bulkhead connector is used to connect the engine and front light wiring harness for easy installation. The engine harness includes connectors for original points type distributors, OE style starter relay connection, tach, and ignition leads, and is supplied with high powered 1-wire alternator connection. The front light harness includes extra long leads to allow for custom routing. Includes original style lamp bulb sockets, connectors and terminals. Also includes full color diagrams and instructions.

Note: This system is intended for use on customized vehicles. Does not support factory ammeter or points-type ignition system. Requires one-wire alternator. Must use original or reproduction dash switches.

ME85629 1970-74 E-Body..... 719.99 ea



Highway Series Modular Fuse Panel Systems

Each universal fuse panel is constructed in heat-resistant nylon and features anti-push back locks and single-side wire access with self-locking, screw-down connections. Includes a starter/alternator 175 amp mega-fuse for extra protection. The panel is fed through an 8-gauge power feed wire and features a battery and accessory stud connection. Includes color-coded wiring for ignition, alternator, headlight, steering column, accessories and gauges. Include relays, fuses, flashers, circuit breakers and all necessary power connections and terminals. Also includes a full-color schematic and step-by-step instructions.



- Composite Panel Base
- Nylon Panel Components
- Color Coded Wire
- Easy to Read Wire Labeling
- Self-Locking Screw Clamp Interface
- 15 Power Outputs
- Gauge Cluster Disconnect
- 8-Gauge Alternator Feed
- 175 Amp MegaFuse
- Ignition, Headlight, Dimmer Switches
- Full Color, Step-by-Step Instructions

Highway 15 Modular Fuse Panel System

Features 15 power outputs in 9 fuses and 1 circuit breaker. Gauge cluster disconnect for easy maintenance. Includes ignition, headlight and dimmer switches.

500703 15 panel connections 409.99 ea



- Composite Panel Base
- Nylon Panel Components
- Color Coded Wire
- Easy to Read Wire Labeling
- Self-Locking Screw Clamp Interface
- 22 Power Outputs
- Gauge Cluster Disconnect
- 8-Gauge Alternator Feed
- 175 Amp MegaFuse
- Ignition, Headlight, Dimmer Switches
- Full Color, Step-by-Step Instructions
- Battery & Accessory Power Extension
- 40 Amp Fan Relay

Highway 22 Modular Fuse Panel System

Features 22 power outputs in 16 fuses and up to 4 circuit breakers. Gauge cluster disconnect for easy maintenance. Includes ignition, headlight and dimmer switches, as well as 40 amp fan relay.

500695 22 panel connections 488.99 ea

Wiring Harnesses

Keep It Clean Pro Wiring Harnesses



AL701207

	AL701201	AL701202	AL701203	AL701204	AL701205	AL701206	AL701207	AL701208
Fuses	8	8	8	8	12	12	12	12
Circuits	10	10	10	10	10	10	10	10
Prewired Terminals	11	11	11	11	11	11	11	11
Dimmer Switch	No	No	Yes	Yes	No	Yes	No	Yes
Headlight Switch	No	No	Yes	Yes	No	Yes	No	Yes
Ignition Switch	No	No	Yes	Yes	No	Yes	No	Yes
Turn Signal & Flasher Harness	No	Yes	No	Yes	No	Yes	Yes	No
Engine Harness	No	Yes	No	Yes	No	Yes	Yes	No
Prewired Harness	No	Yes	No	Yes	No	Yes	Yes	No

Keep It Clean ProComp Wiring Harness

Keep It Clean ProComp wire systems are easy to install and simple to expand. Includes detailed instructions, color-coded and labeled wire and plug-n-play connectors. The ultra small fuse block can be mounted in any position under the dash or seat. Harnesses include built-in relay as well as extra wire. Designed in the USA.

Sets with 12 Fuses

AL701205	139.99 set
AL701206	184.99 set
AL701207	189.99 set
AL701208	239.99 set

The Pro Series System Is The Ultimate Wire Solution From Keep It Clean



AL701209



AL701210

Keep It Clean Pro Series Wiring Harness

The Pro Series system is the ultimate wire solution from Keep It Clean. Thanks to detailed instructions, color-coded and labeled wire, and plug-n-play connectors, Pro Series is easy to install and simple to expand. Extra long leads are included for installation in the event the largest vehicles such as trucks or wagons, and the compact fuse block fits in any position under the dash or seat. Includes 15 fuses, 24 circuits, 188 terminals, accessory kit, engine harness, turn signal/flasher harness, prewired harness, built in relay as well as extra wire. Designed in the USA.

Without Dimmer, Headlight or Ignition Switch	284.99 set
AL701209	284.99 set
With Dimmer, Headlight or Ignition Switch	334.99 set
AL701210	334.99 set

Engine Bay Wiring Harnesses



1964-74 Engine Harnesses

Complete engine wiring harnesses which are ready to install and feature correct colored wires and connectors, making installation as easy as possible. Harnesses include connections for the following: temperature sending unit, oil/light, coil power, horn relay and washer pump motor. All wiring harnesses available are wrapped in non-adhesive vinyl wrap tape for an authentic factory appearance.

Important: *Features a connector to which federal inspectors could attach a testing device, allowing them to check the brake light warning system. For vehicles without this addition, simply just tape the connector out of the way.

Note: No further discounts apply.



A-Body

Points Ignition

MA2268	1971	318/340	all	124.99	ea
MA2270	1972	318/340	all	124.99	ea

Electronic Ignition

MA2269	1971	340	all	145.99	ea
MA2271	1972	340	all	145.99	ea

B-Body

Points Ignition

MB2589	1964	all V8	except Hemi	124.99	ea
MB2391	1964	Hemi	all	184.99	ea
MB2392	1965	all V8	except Hemi	124.99	ea
MB2393	1968	273/318	all	124.99	ea
MB2398	1968	383/440	all	119.99	ea
MB2395	1968	Hemi	all	164.99	ea
MB2395	1969	Hemi	all	164.99	ea
MB2397	1969	318	all	119.99	ea
MB2398	1969	383/440	except Six-Pack	119.99	ea
MB2399	1969	440	Six-Pack	124.99	ea
MB2400	1970	318	all	124.99	ea
MB2401	1970	383/440	except Six-Pack	114.99	ea
MB2402	1970	440	Six-Pack	124.99	ea
MB2403	1970	Hemi	all	205.99	ea
MD2505	1971	318/340	all	139.99	ea
MD2506	1971	Hemi	all	175.99	ea
MD2507	1971	440	Six-Pack	124.99	ea
MD2508	1971	383/440	except Six-Pack	124.99	ea
MD2510	1972	318	all	124.99	ea
MB2407	1972	400/440	w/air pump, w/41-51 amp. alt	124.99	ea
MB2407	1972	400/440	w/air pump, w/60 amp. alt.	124.99	ea

Electronic Ignition

MD2509	1971	340	all	145.99	ea
MD2511*	1972	318/340	w/o air pump, w/41-51 amp alt.	139.99	ea
MB2404	1972	400/440	w/o air pump, w/41-51 amp alt.	144.99	ea
MB2406	1972	400/440	w/air pump, w/41-51 amp alt.	155.99	ea
MB2408	1973	318/340	all	198.99	ea
MB2409	1973	400/440	all	144.99	ea
MB2410	1974	318/360	all	137.99	ea
MB2411	1974	400/440	all	164.99	ea

E-Body

Points Ignition

ME1675	1970	318	2bb1/4bb1	139.99	ea
ME1676	1970	383/440	2bb1/4bb1 w/o Six-Pack	124.99	ea
ME1677	1970	440	Six-Pack	124.99	ea
ME1678	1970	340	Six-Pack	124.99	ea
ME1679	1970	Hemi	all	141.99	ea
MD2505	1971	318/340	all	139.99	ea
MD2506	1971	Hemi	all	175.99	ea
MD2507	1971	440	Six-Pack	124.99	ea
MD2508	1971	383/440	2bb1/4bb1	124.99	ea
MD2510	1972	318	all	124.99	ea

Electronic Ignition

MD2509	1971	340	all	145.99	ea
MD2511*	1972	318/340	w/o air pump w/41-51 amp. alt.	139.99	ea
ME1680	1973	all	all	161.99	ea
ME1681	1974	all	built up to October 12, 1973	137.99	ea
ME1682	1974	all	built after October 12, 1973	199.99	ea



1964-72 Modified Engine Harnesses

These engine harnesses are designed for 1964-72 Dodge and Plymouth models that have been upgraded to electronic ignition. Each harness features correct color wires, factory style connectors, and is wrapped in non-adhesive vinyl wrap. A 1970 or later style alternator with electronic voltage regulator and a 4-terminal ballast resistor (MN1134) are required to accommodate all three types of electronic box.

Note: No further discounts apply.



B-Body

MB2503	1964	all except Hemi	137.99	ea
MB2504	1964	all with Hemi	208.99	ea
MB2505	1965	all	144.99	ea
MB2506	1968-69	all with Hemi	164.99	ea
MB2507	1968	383/440 models	137.99	ea
MB2508	1968	273/318 models	137.99	ea
MB2509	1969	440 Six-Pack models	137.99	ea
MB2510	1969	383/440 except Six-Pack	137.99	ea
MB2511	1969	318 models	137.99	ea
MB2512	1970	all with Hemi	157.99	ea
MB2513	1970	440 Six-Pack models	137.99	ea
MB2514	1970	383/440 except Six-Pack	137.99	ea
MB2515	1970	318 models	137.99	ea
MD2557	1971	383/440 except Six-Pack	137.99	ea
MD2558	1971	440 Six-Pack models	140.99	ea
MD2559	1971	all with Hemi	157.99	ea
MD2516	1972	318 models	137.99	ea

E-Body

ME1693	1970	small block models	138.99	ea
ME1694	1970	383/440 except Six-Pack	137.99	ea
ME1695	1970	340 Six-Pack	137.99	ea
ME1696	1970	440 Six-Pack	137.99	ea
ME1697	1970	all with Hemi	157.99	ea
MD2557	1971	383/440 except Six-Pack	137.99	ea
MD2558	1971	440 Six-Pack models	140.99	ea
MD2559	1971	all with Hemi	157.99	ea
ME1693	1970	small block models	138.99	ea
ME1694	1970	383/440 except Six-Pack	137.99	ea
ME1695	1970	340 Six-Pack	137.99	ea
ME1696	1970	440 Six-Pack	137.99	ea
ME1697	1970	all with Hemi	157.99	ea



1971-72 Emission Control Harness



Emission control harness for 1971-72 A-Body models with automatic transmission.

Note: No further discounts apply.

MA4203	1971-72	A-Body with automatic transmission	19.99	ea
--------	---------	------------------------------------	-------	----

Engine Bay Wiring Harnesses



1964-74 Engine/Front Light Harnesses

Engine/front light harnesses for various 1964-74 Dodge and Plymouth models. Engine/front light harnesses are for vehicles that require a joined engine and front light harness. Our harnesses feature correct color wires, factory style connectors and are wrapped in non-adhesive vinyl wrap tape. They attach to the firewall as original. Firewall connectors will vary depending by model, some models use a single style plug while others use two.

Note: No further discounts apply.



		A-Body	
MA2272	1964	all models	179.99 ea
MA2273	1965	all models	191.99 ea
MA2274	1966	all models	235.99 ea
MA2275	1967	Dart/Valliant	169.99 ea
MA2276	1967	Barracuda	179.99 ea
MA2277	1968	Valliant V8, Dart 318/340	145.99 ea
MA2278	1968	Valliant/Dart slant-6, Dart 383	175.99 ea
MA2279	1968	Barracuda 318/340	185.99 ea
MA2800	1968	Barracuda 383/slant-6	131.99 ea
MA2281	1969	Dart 318/340, Valliant V8	189.99 ea
MA2282	1969	Valliant/Dart slant-6 383/440	174.99 ea
MA2283	1969	Barracuda 318/340	139.99 ea
MA2284	1969	Barracuda 383/440, slant-6	229.99 ea
MA2285	1970	all 318/340 models	189.99 ea
MA2286	1973	all 318/340 models	244.99 ea
MA2287	1974	all V8 models built before October 12, 1973	205.99 ea
MA2288	1974	all V8 models built after October 12, 1973	229.99 ea

		B-Body	
MB2412	1966	Coronet V8 models except Hemi	175.99 ea
MB2413	1966	Coronet V8 models with 5960-amp alt. w/o Hemi	179.99 ea
MB2414	1966	Coronet Hemi models	156.99 ea
MB2415	1966	Charger V8 models except Hemi	289.99 ea
MB2416	1966	Charger Hemi models	275.99 ea
MB2417	1966	Plymouth except Hemi	135.99 ea
MB2418	1966	Plymouth w/heavy-duty 5990 amp alt. w/o Hemi	199.99 ea
MB2419	1966	Plymouth Hemi models	205.99 ea
MB2420	1967	Coronet V8 models except Hemi	175.99 ea
MB2421	1967	Charger V8 models except Hemi	255.99 ea
MB2422	1967	Charger Hemi	301.99 ea
MB2423	1967	Plymouth V8 models except Hemi	175.99 ea
MB2424	1967	Plymouth w/heavy-duty 60-amp alt. w/o Hemi	201.99 ea
MB2425	1967	Dodge/Plymouth Hemi models except Charger	145.99 ea

1962-72 Fender-Mounted Turn Signal Indicator Wires

Turn signal indicator wires/ground strap for 1962-72 A, B and E-Body models. Each wire features an original style cadmium-plated cap, with dimples, that helps ground the turn signal circuit.

Note: Extension harness for Belvedere/Satellite models. Assembly required, includes connectors and heat shrink tubing for proper installation through holes.



Indicator wires

		A-Body	
MD6401	1962-72	16"	49.99 pr
MD6402	1962-72	18"	49.99 pr
MD6403	1967-69	29-1/2"	bullet style 49.99 pr
MD6404	1967-69	29-1/2"	bullet style 49.99 pr
MD6410*	1966	bullet style	25.99 pr
MD6403	1967-69	29-1/2"	bullet style 49.99 pr
MD6404	1967-69	29-1/2"	bullet style 49.99 pr
MD6405	1970-71	32"	with bump on cap 49.99 pr
MD6406	1966-69	32"	with flat cap 49.99 pr
MD6407	1966-69	48"	49.99 pr

		E-Body	
MD6408	1970-71	16" wire	54.99 pr

Ground strap

MD6409	1970	Charger ground	19.99 ea
--------	------	----------------	----------



1964-70 Modified Engine/Front Light Harnesses

Modified engine/front light harnesses for various 1964-70 Dodge and Plymouth models with electronic ignition. Electronic ignition harnesses require use of 1970- and later style alternators and voltage regulators. They also require a 4-terminal ballast resistor, allowing them to accept any of the 3 generations of electronic boxes. Our harnesses feature correct color wires, factory style connectors and are wrapped in non-adhesive vinyl wrap tape for a factory fresh appearance.

Note: No further discounts apply.



		A-Body	
MA2371	1964	all models	239.99 ea
MA2372	1965	all models	229.99 ea
MA2373	1966	all models	169.99 ea
MA2374	1967	Barracuda all engines	195.99 ea
MA2375	1967	Dart/Valliant all engines	209.99 ea
MA2376	1968	Barracuda 383/440	134.99 ea
MA2377	1968	Barracuda 318/340	155.99 ea
MA2378	1968	Dart 318/340 and Valliant V8 models	116.99 ea
MA2379	1968	Dart 383/slant-6 and Valliant slant-6	199.99 ea
MA2380	1969	Dart 318/340 and Valliant V8 models	189.99 ea
MA2381	1969	Dart 383/440 and Valliant slant-6	125.99 ea
MA2382	1969	Barracuda slant-6 and 383/440	189.99 ea
MA2383	1969	Barracuda 318/340	139.99 ea
MA2384	1970	all 318/340 models	189.99 ea

		B-Body	
MB2492	1966	Charger except Hemi models	309.99 ea
MB2493	1966	Charger with Hemi	364.99 ea
MB2494	1966	Coronet V8 models except Hemi	235.99 ea
MB2495	1966	Coronet with Hemi	206.99 ea
MB2496	1966	Plymouth V8 models except Hemi	171.99 ea
MB2497	1966	Plymouth with Hemi	135.99 ea
MB2498	1967	Coronet except Hemi models	199.99 ea
MB2499	1967	Charger V8 models except Hemi	256.99 ea
MB2500	1967	Charger with Hemi	305.99 ea
MB2501	1967	Plymouth V8 models except Hemi	139.99 ea
MB2502	1967	all Hemi models except Charger	145.99 ea



1968-74 Wiper Motor Harness

Replace spliced or non-original wiring with this quality wiper motor harness for 1968-74 A, B and E-Body models to maintain original appearance.

Note: No further discounts apply.



		A-Body	
MD4509	1968	all	45.99 ea
MD4510	1969-72	all	35.99 ea
MA4201	1973-74	all	26.99 ea

		B-Body	
MD4509	1968-69	all built before 11.15.1968 w/2 speed wipers	45.99 ea
MD4510	Late 1969	all built after 11.15.1968	35.99 ea
MD4510	1970	all w/2 speed wipers	35.99 ea
MD4511	1971-72	all w/o emission control air pump	29.99 ea
MB1804	1972	all w/emission control air pump & 2 spd wipers	39.99 ea
ME8100	1973-74	all w/2 speed wipers	39.99 ea

		E-Body	
MD4511	1970-73	all w/2 speed wipers	29.99 ea
ME8100	1974	all w/2 speed wipers	39.99 ea

Engine Bay Wiring Harnesses



1966-74 Fusible Links

Replacement fusible links are made with the same high quality materials and workmanship as our wiring harnesses. These fusible links are offered separately for minor repairs that require changing only the fusible link. Wiring harness part numbers, in parentheses, are given here to help you find the correct application on our wiring harness applications below.

Note: Fusible links are included with all wiring harnesses where applicable. No further discounts apply.

* For models with 59 and 60-amp alternators.

** For models with ignition, air pump and 60-amp alternator.



1964-74 Front Light Harness

Front light harnesses for various 1964-74 Dodge and Plymouth models. Front light harnesses are for vehicles that require a separate engine harness. Each harness features correct color wires, factory style connectors and is wrapped in non-adhesive vinyl wrap tape. Harnesses attach to the firewall as original. The firewall connectors will vary depending by model as some models use a single style plug while others use two.



Note: No further discounts apply.

Fusible Link for Engine/Forward Light Harness

A-Body	
MA4200	1967 Valiant and Barracuda (for MA2275)..... 25.99 ea
MA4200	1967 Barracuda (for MA2276)..... 25.99 ea
MA4200	1968 Valiant V8 and Dart 318,340 (for MA2277)..... 25.99 ea
MA4200	1968 Valiant and Dart slant-6, 383 (for MA2280)..... 25.99 ea
MA4200	1969 Valiant V8 and Dart 318,340 (for MA2281)..... 25.99 ea
MA4200	1969 Valiant & Dart slant-6, 383, 440 (for MA2282)..... 25.99 ea
MA4200	1969 Barracuda 318,340 (for MA2283)..... 25.99 ea
MA4200	1969 Barracuda slant-6, 383, 440 (for MA2284)..... 25.99 ea
MA4200	1970 all 318,340 (for MA2285)..... 25.99 ea
MD4506	1967 all 318,340 (for MA2286)..... 25.99 ea
MD4507	1974 all built before 10.12.1973 (for MA2287)..... 25.99 ea
MD4507	1974 all built after 10.12.1973 (for MA2288)..... 25.99 ea
B-Body	
MB1800	1966 Plymouth with Hemi (for MB2419)..... 19.99 ea
MB1800	1966 Coronet with Hemi (for MB2414)..... 19.99 ea
MB1800	1966 Charger with Hemi (for MB2416)..... 19.99 ea
MB1801*	1966 Plymouth (for MB2418)..... 25.99 ea
MB1801*	1966 Coronet (for MB2413)..... 25.99 ea
MB1802	1966 Plymouth (for MB2421)..... 24.99 ea
MB1802	1966 Coronet (for MB2412)..... 24.99 ea
MB1801	1966 Charger exc. Hemi (for MB2415)..... 25.99 ea
MB1803	1967 Plymouth V8 models exc. Hemi (for MB2423)..... 25.99 ea
MB1803	1967 Coronet (for MB2420)..... 25.99 ea
MB1803	1967 Hemi models except Charger (for MB2425)..... 25.99 ea
MB1803	1967 Hemi Charger (for MB2422)..... 25.99 ea
MB1803	1967 Charger w/o Hemi (for MB2421)..... 25.99 ea
Fusible Link for Engine Harness	
MA4200	1971 all 318,340 (for MA2268)..... 25.99 ea
MD4506	1972 all 318,340 w/electronic ignition (for MA2271)..... 25.99 ea
B-Body	
MB1803	1968 273, 318 (for MB2393)..... 25.99 ea
MB1803	1968 383,440 (for MB2394)..... 25.99 ea
MB1803	1968-69 426 Hemi (for MB2395)..... 25.99 ea
MB1803	1969 318 (for MB2397)..... 25.99 ea
MB1803	1969 383,440 (for MB2398)..... 25.99 ea
MB1803	1969 440 6-bbl (for MB2399)..... 25.99 ea
MB1803	1970 318 (for MB2400)..... 25.99 ea
MB1803	1970 383,440 (for MB2401)..... 25.99 ea
MB1803	1970 426 Hemi (for MB2403)..... 25.99 ea
MB1803	1970 440 6-bbl (for MB2402)..... 25.99 ea
MD4506**	1972 big-block models (for MB2407)..... 25.99 ea
Fusible Link for Forward Light Harness	
B-Body	
MD4508	1971 Plymouth w/hood-mounted t/s (for MB2486)..... 25.99 ea
MD4508	1971 Plymouth w/fender-mounted t/s (for MB2487)..... 25.99 ea
MD4508	1971 Charger w/hood-mounted t/s (for MB2489)..... 25.99 ea
MD4508	1971 Charger w/o hidden headlights (for MB2488)..... 25.99 ea
MD4507	1972 all models (for MB2490)..... 25.99 ea
MD4507	1972 Plymouth w/o air grabber (for MB2492)..... 25.99 ea
MD4507	1973 Plymouth (for MB2493)..... 25.99 ea
MD4507	1974 Plymouth (for MB2495)..... 25.99 ea
E-Body	
MD4508	1970 Barracuda (for MD2496)..... 25.99 ea
MD4508	1971 Barracuda (for MD2497)..... 25.99 ea
MD4508	1970-71 Challenger (for MD2500)..... 25.99 ea
MD4507	1972-73 Barracuda (for MD2498)..... 25.99 ea
MD4507	1974 Barracuda (for MD2499)..... 25.99 ea
MD4507	1974 Challenger (for MD2502)..... 25.99 ea

A-Body	
MD2471	1971 all models..... 165.99 ea
MD2472	1972 all models..... 159.99 ea
B-Body	
MD2473	1964 Plymouth..... 96.99 ea
MD2621	1964 Dodge..... 209.99 ea
MD2618	1965 Plymouth..... 209.99 ea
MD2619	1965 Dodge..... 209.99 ea
MD2477	1968 Plymouth..... 169.99 ea
MD2628	1968 Coronet, Super Bee..... 209.99 ea
MD2629	1968 Charger..... 214.99 ea
MD2480	1969 all except Charger..... 214.99 ea
MD2631	1969 Charger..... 214.99 ea
MD2633	1970 Coronet, R/T, Super Bee, w/fender signals..... 239.99 ea
MD2633	1970 Coronet, R/T, Super Bee, w/fender signals..... 239.99 ea
MD2484	1970 all Plymouth, Charger, except Superbird..... 199.99 ea
MD2485	1970 Superbird..... 259.99 ea
MD2636	1971 Plymouth w/hood-mounted signals..... 214.99 ea
MD2487	1971 all w/concealed headlights and fender signals..... 175.99 ea
MD2488	1971 Charger w/o concealed lights, or fender signals..... 175.99 ea
MD2489	1971 Charger w/concealed headlights..... 225.99 ea
MD2635	1972 all w/o concealed lights or fender signals..... 214.99 ea
MD2491	1972 all with concealed headlights..... 185.99 ea
MD2492	1972 Plymouth w/o air grabber, w/hood signals..... 165.99 ea
MD2493	1973 all Plymouth except 4-door station wagon..... 195.99 ea
MD2494	1973 all 4-door station wagons..... 165.99 ea
MD2495	1974 all Plymouth..... 165.99 ea
E-Body	
MD2622	1970 Barracuda..... 209.99 ea
MD2623	1971 Barracuda..... 239.99 ea
MD2624	1972-73 Barracuda..... 214.99 ea
MD2499	1974 Barracuda..... 165.99 ea
MD2625	1970-71 Challenger..... 239.99 ea
MD2626	1972-73 Challenger..... 214.99 ea
MD2502	1974 Challenger..... 165.99 ea

E-Body	
MD2622	1970 Barracuda..... 209.99 ea
MD2623	1971 Barracuda..... 239.99 ea
MD2624	1972-73 Barracuda..... 214.99 ea
MD2499	1974 Barracuda..... 165.99 ea
MD2625	1970-71 Challenger..... 239.99 ea
MD2626	1972-73 Challenger..... 214.99 ea
MD2502	1974 Challenger..... 165.99 ea



1970-71 Idle Control Solenoid Harnesses

Idle control solenoid harnesses for 1970-71 A and E-Body models and idle stop solenoid extension wire for 1971 B-Body 440 Six-Pack models.

Note: No further discounts apply.

1970-71 Idle Control Solenoid Harness	
MD4512	1970 A-Body with 340..... 17.99 ea
MD4512	1971 E-Body 340 with 2-bbl..... 17.99 ea
MB1801	1971 E-Body 340 with 4-bbl..... 11.99 ea
1971 Idle Stop Solenoid Extension	
MB1805	1971 B-body with 440 Six-Pack..... 5.99 ea
MB1802	1971 E-Body 383 with 4-rd speed..... 25.99 ea



N BATTERIES & WIRING

Wiring Harnesses



1965-74 A, B & E-Body Tachometer Harnesses

Tachometer harness for 1965-74 A, B and E-Body models with factory tachometer. Add a tachometer to your Mopar with one of these factory correct replacement tachometer harnesses.

Note: No further discounts apply.



Dash Side				
A-Body				
MA4215	1965	all	35.99 ea
B-Body				
MB1822	1968-70	with Rallye gauges	39.99 ea
MB1823	1968-70	without Rallye gauges	35.99 ea
Engine Side				
B-Body				
MB1824	1968	small block	6.99 ea
MB1825	1968	big block except Hemi	11.99 ea
MB1826	1969	small block	6.99 ea
MB1827	1969	big block except Hemi w/o Rallye gauges	11.99 ea
E-Body				
ME8111	1970	small block	14.99 ea
ME8112	1970	big block	14.99 ea
ME8113	1971	big block	11.99 ea
ME8114	1974	with Rallye gauges	14.99 ea



1968-74 Back-Up Lamp/Neutral Safety Switch Harness

Back-up lamp/neutral safety switch harness for 1968-74 A, B and E-Body models with automatic transmission and 1968-74 B and E-Body models with clutch safety switch. The back-up lamp/neutral safety switch harness connects the back-up lamp/neutral safety switch to the bulkhead connector. The 1968 B-Body has a wire connecting the neutral safety switch to the starter relay. The clutch safety switch lead wire connects the clutch switch on the pedal to the starter relay. Harness will not fit any Hemi model.

Note: No further discounts apply.



Automatic Transmission				
A-Body				
MD4514	1969	built before November 15, 1968	49.99 ea
B-Body				
MD4514	1969	built before November 15, 1968	49.99 ea
MB1829	1969	built after November 15, 1968	49.99 ea
MD4515	1971	all	25.99 ea
MD4516	1971	all with NOX emission controls	25.99 ea
MD4517	1972-74	all	35.99 ea
E-Body				
MD4515	1970-71	all	25.99 ea
MD4516	1971	all with NOX emission controls	25.99 ea
ME8117	1971	all without NOX emission controls	19.99 ea
MD4517	1972-74	all	35.99 ea
Manual Transmission				
A-Body				
MD4518	1970-74	clutch safety switch lead wire	11.99 ea
B-Body				
MB1830	1968	neutral safety switch to starter relay	11.99 ea
MB4518	1970-74	clutch safety switch lead wire	11.99 ea
E-Body				
MD4518	1970-74	clutch safety switch lead wire	11.99 ea



1964-74 Under-Dash Harnesses

Replacement under-dash harnesses for various 1964-74 Dodge and Plymouth models. Harnesses feature correct color wires, factory style connectors and are wrapped in non-adhesive vinyl wrap tape. Under-dash harnesses connect to various switches and sensors related to the dash. The harness also connects to the engine harness and runs down the side cowl panel and connects to the rear body harness.

Important: When ordering a new wiring harness, inspect the original harness on the vehicle. Chrysler often added separate wire assemblies depending on the vehicle's final configuration. Many of these separate harnesses are not available and if needed they will have to be reused. Owners of early 1972 models that do not have the seat belt warning system should disregard the connector and tape it off out of the way.

Note: No further discounts apply.



A-Body				
MA2299	1964	Valiant	449.99 ea
MA2300	1964	Dart	549.99 ea
MA2301	1965	Barracuda/Valiant	624.99 ea
MA2302	1965	Dart	485.99 ea
MA2303	1966	Valiant	471.99 ea
MA2304	1966	Barracuda	535.99 ea
MA2305	1966	Dart	549.99 ea
MA2306	1967	Valiant	471.99 ea
MA2307	1967	Barracuda	414.99 ea
MA2308	1967	Dart	431.99 ea
MA2309	1968	Valiant	469.99 ea
MA2310	1968	Barracuda	519.99 ea
MA2311	1968	Dart	519.99 ea
MA2312	1969	Valiant	539.99 ea
MA2313	1969	Barracuda	524.99 ea
MA2314	1969	Dart	519.99 ea
MA2315	1970	Duster/Valiant 340	451.99 ea
MA2316	1970	Dart/Duster 340	519.99 ea
MA2317	1971	Demon/Duster except 340	529.99 ea
MA2318	1971	Demon/Duster 340 with gauges	451.99 ea
MA2319	1971	Dart except 340	451.99 ea
MA2323	1972	all models	484.99 ea
MA2324	1972	all early production models	561.99 ea
MA2325	1973	all models	584.99 ea
MA2326	1974	all models	519.99 ea
B-Body				
MB2432	1964	Plymouth	441.99 ea
MB2433	1964	Dodge	571.99 ea
MB2434	1965	Plymouth	549.99 ea
MB2435	1965	Dodge	474.99 ea
MB2436	1966	Plymouth	519.99 ea
MB2437	1966	Dodge except Charger	431.99 ea
MB2438	1966	Charger	519.99 ea
MB2439	1967	Plymouth	569.99 ea
MB2440	1967	Dodge except Charger	519.99 ea
MB2441	1967	Charger	431.99 ea
MB2442	1968	all models with oil light	519.99 ea
MB2443	1968	all models with oil gauge	469.99 ea
MB2444	1969	all models with oil light	474.99 ea
MB2445	1969	all models with oil gauge	474.99 ea
MB2446	1970	all models with oil light	431.99 ea
MB2447	1970	all models with oil gauge	474.99 ea
MB2448	1971	all models without gauges	451.99 ea
MB2449	1971	all models with gauges	525.99 ea
MB2450	1972	all models without gauges	484.99 ea
MB2451	1972	all models with gauges	565.99 ea
MB2452	1973	all models without gauges	519.99 ea
MB2453	1973	all models with gauges	565.99 ea
MB2454	1974	all models without gauges	519.99 ea
MB2455	1974	all models with gauges	604.99 ea
E-Body				
ME1683	1970	without Rallye gauges	535.99 ea
ME1684	1970	with Rallye gauges	595.99 ea
ME1685	1971	without Rallye gauges	519.99 ea
ME1686	1971	with Rallye gauges	519.99 ea
ME1687	1972	without Rallye gauges	565.99 ea
ME1688	1972	with Rallye gauges	664.99 ea
ME1689	1973	without Rallye gauges	484.99 ea
ME1690	1973	with Rallye gauges	519.99 ea
ME1691	1974	without Rallye gauges	519.99 ea
ME1692	1974	with Rallye gauges	519.99 ea

Wiring Harnesses



1968-70 Rear Seat Speaker Harness

Replace your spliced, damaged or missing rear seat speaker harness for your 1968-70 B-Body. For models with one rear speaker.

Note: No further discounts apply.

MB1828 1968-70 B-Body..... 25.99 ea



MER119



MER121

1965-74 AC and Heater Harness

AC and heater harness for 1965-74 A, B and E-Body models. These are available as the engine side harness and the dash side harness. Now you can replace those old, hard, spliced and discolored harnesses with a brand new harness to keep your AC in peak operating condition while maintaining originality.

Note: No further discounts apply.



Dash-Side Harness

A-Body			
MA4204	1965	all.....	59.99 ea
MA4205	1966	all.....	54.99 ea
MA4206	1967	Valiant.....	39.99 ea
MA4207	1967	Dart.....	39.99 ea
MA4208	1968-69	Barracuda/Dart.....	59.99 ea
MA4209	1968-69	Valiant.....	61.99 ea
MA4209	1970	all except with 340.....	61.99 ea
MA4209	1971	2 door fastback, Swinger.....	61.99 ea
MA4209	1972	all.....	61.99 ea
MA4210	1970	all with 340.....	45.99 ea
MA4210	1971	2 and 4 door.....	45.99 ea
MA4211	1973	all.....	46.99 ea
MA4212	1974	all.....	39.99 ea

B-Body			
MB1806	1965	all.....	49.99 ea
MB1807	1966	Belvedere.....	44.99 ea
MB1808	1966	Coronet.....	39.99 ea
MB1809	1967	Belvedere, Satellite, GTX.....	49.99 ea
MB1810	1967	Coronet.....	39.99 ea
MB1811	1968-70	all.....	55.99 ea
MB1812	1971-72	all.....	49.99 ea
MB1813	1973	all.....	71.99 ea
MB1814	1974	all.....	44.99 ea

E-Body			
MER119	1970-73	all.....	45.99 ea
MER120	1974	all.....	46.99 ea

Engine-Side Harness

MA4213	1972	all with emission controls.....	25.99 ea
MA4214	1973	all with V8.....	45.99 ea

B-Body			
MB1815	1968	all.....	29.99 ea
MB1816	1969	all.....	29.99 ea
MB1817	1970	all with V8.....	29.99 ea
MB1818	1972	all.....	19.99 ea
MB1819	1973	all.....	19.99 ea
MB1820	1973	AC ext harness- all equipped w/AC relay.....	25.99 ea
MB1821	1974	all.....	32.99 ea

E-Body			
MER123	1970	all with V8.....	29.99 ea
MER123	1971	all.....	29.99 ea
MER104	1971	AC low pressure switch cut-off ext harness.....	5.99 ea



MD4522



MD4519

1967-72 Back-up Lamp Harness

Back-up lamp harness for 1967-72 A, B and E-Body models. The back-up lamp harness connects the bulkhead to the transmission back-up switch. Other connections may vary depending on your particular model. Harness does not fit any Hemi model; Hemi back-up lamp harness is incorporated into the positive battery cable. Back-up lamp harness is for manual transmissions only; neutral safety switch incorporates the back-up lamp feature.

Note: No further discounts apply.

* Models built late 1968 and early 1969 before November 15, 1968.

** Models built late 1969 after November 15, 1968.

*** Models without NOX emission controls.



Manual Transmission

A-Body			
MA4216	1967	Barracuda 4 speed.....	9.99 ea
MD4520	1968	all.....	35.99 ea
MD4521	1968-70	all.....	35.99 ea
MD4522	1968-69*	4 speed.....	25.99 ea
MA4217	1971	3 speed.....	25.99 ea
MA4218	1971	4 speed.....	25.99 ea

B-Body			
MD4520	1967-68	all.....	35.99 ea
MD4522	1968-69*	all.....	25.99 ea
MD4521	1969**	all.....	35.99 ea
MD4521	1970	all.....	35.99 ea
MD4519	1971-72***	4 speed except Hemi.....	25.99 ea
MD4523	1971	3 speed w/NOX emission controls.....	24.99 ea
MD4513	1971	SB 4 speed w/NOX emission controls.....	21.99 ea

E-Body			
MER122	1970	3 speed.....	19.99 ea
MD4519	1970***	4 speed exe Hemi.....	25.99 ea
MD4523	1971	3 speed w/NOX emission controls.....	24.99 ea
MD4513	1971	Small Block 4 speed w/NOX emission controls.....	21.99 ea
MER115	1971	3 speed w/o NOX emission controls.....	19.99 ea
MER116	1971	4 speed w/o NOX emission controls.....	29.99 ea



MER105



MER109

1970-71 E-Body Overhead Console Harness

Overhead console wiring harness and extensions for 1970-71 E-Body models equipped with overhead console. The console to body harness needs three other harness extensions to operate all overhead console functions. You will need the console to fuel relay extension which connects the overhead console to the low-fuel relay harness. The low-fuel relay harness connects the dash harness with the fuel relay extension. Then the door ajar switch extension connects the right door-ajar switch to the body harness and completes the overhead console wiring.

Note: No further discounts apply.



Console to Body			
MER105	1970	all.....	79.99 ea
MER106	1971	all.....	75.99 ea

Console to Fuel Relay Extension			
MER107	1970	all.....	49.99 ea
MER108	1971	all.....	65.99 ea

Low-Fuel Relay Extension			
MER109	1970-71	all.....	65.99 ea

Door Ajar Switch Extension			
MER110	1970-71	all.....	7.99 ea

Wiring Harnesses

1964-74 Rear Lamp Harnesses



Replacement rear body lamp harnesses for various 1964-74 Dodge and Plymouth models. The rear lamp harness powers all accessories on the rear end of the vehicle and connects to the under-dash harness. These harnesses feature correct color wires, factory style connectors and are wrapped in non-adhesive vinyl wrap tape.



MB2482

Important: *Except Charger and convertible models. None of these harnesses will fit station wagon models.
 Note: No further discounts apply.

A-Body Models

1964 Models	
MA2332 Valiant w/back-up lamps	89.99 ea
MA2333 Barracuda	85.99 ea
MA2334 Dart	114.99 ea

1965 Models	
MA2335 Valiant	89.99 ea
MA2336 Barracuda	114.99 ea
MA2337 Dart	101.99 ea

1966 Models	
MA2338 Valiant	79.99 ea
MA2339 Valiant convertible	89.99 ea
MA2340 Barracuda	104.99 ea
MA2341 Dart	89.99 ea
MA2342 Dart convertible	65.99 ea

1967 Models	
MA2343 Valiant	79.99 ea
MA2344 Barracuda coupe	109.99 ea
MA2345 Barracuda fastback	116.99 ea
MA2346 Barracuda convertible	139.99 ea
MA2347 Dart	101.99 ea
MA2348 Dart convertible	114.99 ea

1968 Models	
MA2349 Valiant	101.99 ea
MA2350 Barracuda coupe	94.99 ea
MA2351 Barracuda fastback	124.99 ea
MA2352 Barracuda convertible	114.99 ea
MA2353 Dart	119.99 ea
MA2354 Dart convertible	91.99 ea

1969 Models	
MA2355 Valiant	81.99 ea
MA2356 Barracuda coupe	76.99 ea
MA2357 Barracuda fastback	81.99 ea
MA2358 Barracuda convertible	95.99 ea
MA2359 Dart	111.99 ea
MA2360 Dart convertible	101.99 ea

1970 Models	
MA2361 Duster	102.99 ea
MA2362 Dart 2-door coupe	104.99 ea

1971 Models	
MA2362 Dart/Valiant 2-door coupe	104.99 ea
MA2363 Duster	55.99 ea
MA2364 Demon	89.99 ea

1972 Models	
MA2365 Dart/Valiant 2-door coupe	96.99 ea
MA2366 Duster	111.99 ea
MA2367 Demon	116.99 ea

1973 Models	
MA2365 Dart/Valiant 2-door coupe	96.99 ea
MA2368 Dart Sport/Duster	114.99 ea

1974 Models	
MA2369 exc. Dart Sport/Duster	114.99 ea
MA2370 Dart Sport/Duster	114.99 ea

B-Body Models

1964 Models	
MB2459 Plymouth w/back-up lamps	149.99 ea
MB2460 Polar/Polar 500	104.99 ea
MB2461 Dodge 330/440	104.99 ea

1965 Models	
MB2462 Belvedere/Satellite	94.99 ea
MB2463 Coronet	109.99 ea

B-Body Models - Continued

1966 Models	
MB2464 Belv./Coronet coupe	94.99 ea
MB2465 Belv./Coronet convertible	149.99 ea
MB2466 Charger	169.99 ea

1967 Models	
MB2467 Plymouth coupe/sedan models	99.99 ea
MB2468 Plymouth convertible models	149.99 ea
MB2469 Dodge coupe/sedan models	119.99 ea
MB2470 Dodge convertible models	157.99 ea
MB2471 Charger	174.99 ea

1968 Models	
MB2472* all	159.99 ea
MB2473 all convertible models	164.99 ea
MB2474 Charger	125.99 ea

1969 Models	
MB2475 Dodge w/1 light option	99.99 ea
MB2476 Dodge w/2 light option	165.99 ea
MB2477 Dodge w/2 light option	61.99 ea
MB2478 Charger	165.99 ea
MB2479 Plymouth coupe models	99.99 ea
MB2480 Plymouth convertible	199.99 ea

1970 Models	
MB2481 Plymouth coupe	129.99 ea
MB2482 Plymouth convertible	165.99 ea
MB2483 Coronet/Coronet 440/Super Bee	119.99 ea
MB2484 Coronet 500 and R/T	104.99 ea
MB2485 Dodge convertible models	174.99 ea
MB2486 Charger	134.99 ea

1971 Models	
MB2487 all models	155.99 ea

1972 Models	
MB2488 all models	91.99 ea

1973 Models	
MB2488 all models	91.99 ea

1974 Models	
MB2489 all models	64.99 ea

E-Body Models

1970 Models	
ME1702 Barracuda coupe	94.99 ea
ME1703 Barracuda convertible	199.99 ea
ME1708 Challenger coupe	169.99 ea
ME1709 Challenger convertible	169.99 ea

1971 Models	
ME1704 Barracuda coupe	165.99 ea
ME1705 Barracuda convertible	105.99 ea
ME1710 Challenger coupe	125.99 ea
ME1711 Challenger convertible	86.99 ea

1972 Models	
ME1706 Barracuda coupe	146.99 ea
ME1712 Challenger coupe	115.99 ea

1973-74 Models	
ME1707 Barracuda coupe	125.99 ea
ME1712 Challenger coupe	115.99 ea

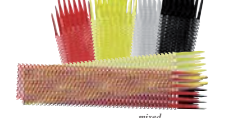

ZipStrip Re-Useable Flexible Cable Ties

Tired of cutting off plastic cable ties? ZipStrip re-useable and flexible cable ties are the answer! Made from a custom elastomer for softness, strength, and controlled tension, these 11" strips stretch by more than 50%, wind neatly around cables, and can be easily removed. Each strip can be used 3-5 times. Available in red, yellow, clear, black or a mixed assortment of colors.

MC200101 red	9.99 set
MC200102 yellow	9.99 set
MC200103 clear	9.99 set
MC200104 black	9.99 set
MC200105 mixed	9.99 set



3 Position Oval Rocker Switch

Modernize your interior with this handsome 3 position rocker switch. This switch has 6 pins in a stag configuration, is rated for 20 amps, and has an amber backlight.

AL701101	24.99 ea
AL701100 6 pin harness	11.99 ea



Billet Aluminum Rocker Switches

Add style and flair to your interior with these billet aluminum rocker switches, compatible with both factory and aftermarket power windows. Durable construction and corrosion resistant contacts ensure smooth operation and long life.

AL701102 flame	44.99 ea
AL701100 6 pin harness	11.99 ea

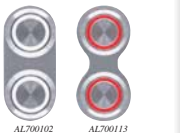

AL700102

AL700113

unlit

white

red

orange

yellow

green

blue



Billet Toggle Switches

These stunningly smooth billet switches, with either Daytona or Retro style bezels, are perfect for power windows, power door locks, headlights, or anything that uses a momentary switch. For an added custom touch, these switches are available illuminated in a variety of alluring colors. Switches are 22mm wide by 54mm long by 41mm deep.

Daytona Style Switches	
AL700101 non-illuminated	59.99 ea
AL700102 white LED	69.99 ea
AL700103 red LED	69.99 ea
AL700104 orange LED	69.99 ea
AL700105 yellow LED	69.99 ea
AL700106 green LED	69.99 ea
AL700107 blue LED	69.99 ea

Retro Style Switches	
AL700111 non-illuminated	59.99 ea
AL700112 white LED	69.99 ea
AL700113 red LED	69.99 ea
AL700114 orange LED	69.99 ea
AL700115 yellow LED	69.99 ea
AL700116 green LED	69.99 ea
AL700117 blue LED	69.99 ea

RON FRANCIS Wiring



- 18 Circuits on 16 Fuses
- 4 Select-A-Circuits
- Cooling Fan Relay Included
- Serial Number
- Handles 100 Amp Alternators
- Includes the Proper Connectors & Terminals
- Clear, Simple, Color Coded Instructions
- Clear Coated, Polished Stainless Steel Finish
- Faster Installation w/vNew Style Terminal Block

1961-75 A, B & E-Body Express Wiring Harness

This express wiring harness for one-wire alternator applications has been improved over previous models to simplify installation. Each kit includes a headlight switch, isolated cooling fan relay, & wiring for hi & low beams, indicator lights, brake, turn signal, parking, and third brake light. It will accommodate points, aftermarket and electronic (factory or dealer supplied) distributors, and can be connected to the Chrysler starter relay for use of the factory transmission-mounted neutral safety switch. A multi-connection battery junction block reduces the number of wires needed for add-ons. Our printed and color-coded high temperature fire-resistant wiring is supplied for all circuits, including for the lighting needed for most safety inspections, and features a unique serial number. Applications available for 1961-75 Challenger, Barracuda, Satellite, Challenger, Charger, Dart, Coronet.

MD4239 1961-75 A, B & E-Body 474.99 ea



Timed Cooling System Shutdown

Timed cooling system shutdown features adjustable relays that keep power to the cooling fan and electric water pump (if equipped) when the key is shut off. This reduces the block temperature as much as possible without the risk of killing the battery. This is a timed circuit and does not use a thermostat or other fan control to operate.

Note: Not compatible with probe style fan sensor controls that mount on the radiator or radiator support.

TP900632 1962-79 149.99 ea



- 10 circuits on 16 fuses
- Fuse panel measures 7-1/2" x 3-1/8" x 2-7/8"
- Plugs for Mopar Saginaw or Aftermarket Steering Columns
- Set up for One-Wire 140-Amp Alternators
- Wiring for:
 - ✓ Safety Inspections
 - ✓ Gauges
 - ✓ Engine
 - ✓ Dash Lighting
 - ✓ Basic Accessories

Mopar Bare Bonz Wiring Set

Mopar Powered Rodders with the need for only a simple electrical system will love this model. We don't use an old GM fuse block and call it universal. We do it right. This kit has 8 fuses and 10 circuits and plenty of wire needed to take care of your basic engine, dash and lighting, gauges and some accessories yet built well enough to be compatible with electronic fuel injection. This panel measures 7-1/2" long x 3-1/8" wide x 2-7/8" high.

MD4236 394.99 set



Mopar Access 24/7 Wiring Set

This fuse system comes standard with 24 fuses and 3 relays, along with a unique mounting system and room for 4 additional relays. The Access 24/7 allows you to consolidate even additional aftermarket products' relays to clean up the underdash area. Fuse panel can be conveniently placed under the dashboard for easy servicing or maintenance. Additional wires simply plug into labeled connectors in the fuse panel. No hard-wiring is necessary to add accessories or other circuits to the fuse panel.

MD4235 544.99 set

PAINLESS Wiring



21-Circuit Harnesses Include Wiring For:

- Headlamp Switch
- Dimmer Switch
- Wiper Switch
- Turn Signal Switch
- Ignition Switch
- Brake Switch
- Courtesy Lamps
- Alternator
- Horn
- Radio
- Starter
- Dash Instruments
- Tail Lights
- Third Brake Light
- Electric Choke & Senders
- Emergency Flashers

21 Circuit Universal Wiring Harness

This universal 21-circuit harness is configured for 1966-76 Mopar vehicles and features OEM color codes and a unique covered micro-fuse block. Harness includes an auxiliary circuit with 20 amp relay for accessories such as fog lights, electric seats, electric window/lock or an electric fuel pump.

Important: For non-fuel injected motor and non-electronic transmission.

Note: No further discounts apply.

10127 1966-76 574.99 ea



14 & 18 Circuit Universal Fuse Blocks

Use these 14 or 18 circuit OEM style pre-wired fuse blocks to replace your existing fuse block or as a starting point for custom wiring. All you have to do is terminate your circuit wire and attach it to the fuse block. Pre-wired and labeled for AC and heat, gauges, dash instruments, brake lights, headlights, coil, horn, dome light, radio, electric fan, turn signals, emergency flashers, wipers and alternator. The 18 circuit fuse block adds labeled circuits for power windows, door locks and other optional accessories. Kits include: mounting bracket, fuses, flashers, horn relay, terminals, and full instructions.

Important: No wire included with these kits.

Note: No further discounts apply.

30001 14 circuit 154.99 ea

30003 18 circuit 259.99 ea



Add Fused Circuits with The CirKit Boss!

These sets allow you to add 3 fused circuits to your existing factory fuseblock. Simply mount the fuse block and relay, route the large 10 gauge wire to the battery, route the ignition wire and then route the accessory circuits to the accessories needing power. Main power wire is 8 feet long from fuse block. Each accessory circuit has 8 feet of wire length from fuse block. 3 ignition hot circuits with a maximum total Amperage handling of 70 Amps. Set includes: One 70 Amp SPST Relay, Relay base/fuse block with harness, Crimp-on terminals and hardware.

Note: No further discounts apply.

70114 3-Circuit 91.99 set



Remote Master Disconnects

These kits allow you to add a remote power disconnect switch as a theft deterrent or for safety in racing applications. Two sets are available for applications with high amperage alternators; one set includes with a small toggle switch to activate the solenoid, and the other set includes with a red emergency push button. The 110 amp continuous duty mechanical latch solenoid is activated by an easy to hide momentary push button.

Note: No further discounts apply.

30204 250 amp w/toggle switch 149.99 set

30205 250 amp w/emergency button. 169.99 set

30206 110 amp w/momentary switch 179.99 set



250 Amp Dual Battery Control System

This 250 amp dual battery controller uses a three position switch to control the second battery through the operation of the solenoid. Position one isolates the second battery, position two connects the battery while the ignition is on, position three connects the second battery at all times. Includes solenoid, switch, pre-terminated wire/connectors, fuse holder, fuse and hardware.

Note: No further discounts apply.

40102 191.99 ea

40103 weatherproof 249.99 ea



Digital Power Manager

The Digital Power Manager is a weatherproof solid state dual battery control unit that automatically engages an auxiliary battery when a large enough load is placed on the vehicle's main battery. The unit will not allow the electrical loads on the vehicle's main start battery to drain the auxiliary battery, preventing a potential stranded situation for the driver. When the main start battery is too low to crank the engine by itself, the Digital Power Manager will combine the auxiliary and main batteries to crank the engine. Once the engine is running and spinning the alternator again, it will only allow charging of the auxiliary battery after the main battery is fully recharged by the alternator. This solid state dual battery controller / battery isolator eliminates manual switching or any second guessing when using a secondary battery in any vehicle with a 12 volt system. The unit is capable of switching up to 280 amperes of DC current for large loads such as winches or even when jump starting another vehicle. Ideal for any vehicle equipped with high power stereo systems, high amp driving lights or winches. Included in the set is the weather proof Digital Power Manager, 6 gauge connection cables, terminals, heat shrink, mounting hardware and a remote indicator lamp.

Note: No further discounts apply.

40120 205.99 set



Circuit Add-On Isolators

Protect your OEM warranty or simply isolate additional circuits when required. The circuit add-on isolator is a cost-effective solution when additional circuits are needed, or accessory equipment requires ignition-hot and constant hot capabilities. This is the only add-on fuse center available with ignition-hot capabilities to ensure that add-on circuits will only work if the ignition key is on. Three or seven circuit models depending on your application. Relay included.

Note: No further discounts apply.

Three Circuit

70103 2 ignition hot, 1 constant hot..... 67.99 ea

Seven Circuit

70107 4 ignition hot, 3 constant hot..... 81.99 ea

Get Custom Digital Wiring With Infinitybox!

Upgrade, Consolidate and Control Your Wiring With an Infinitybox Wiring System

Infinitybox is an intelligent wiring system that can replace or enhance the traditional point-to-point wiring in any vehicle – regardless of make, model or year. It uses modern technology to not only control standard features like head lamps, turn signals, and electric fans, but also allows the flexibility to easily add features like power windows, iPhone control, and advanced anti-theft security. Infinitybox makes it easy to add these features and more, all while simplifying the process of re-wiring your car, adding circuit diagnostic capabilities, and creating a more reliable and dynamic wiring system. All wiring harnesses and modules are made in the USA!

Note: No further discounts apply.



Control Motors and Actuators

The inMOTION module controls items that change direction like convertible top motors, sunroofs, and power windows and locks.

Single-Wire Connections

A single data cable connects each POWERCELL to the MASTERCELL. All inputs are powered and switched through the MASTERCELL alone, eliminating hundreds of feet of wire!

System Flexibility

The Infinitybox POWERCELL uses solid state switches called MOSFETs for switching. POWERCELL outputs can turn things on and off, or can be variable for lighting effects and motor speed control.



INFINITYBOX
INTELLIGENT WIRING

- ✓ Add New-Car Tech Without Excessive Wiring & Relays!
- ✓ Reduce Installation Time by up to 50%!¹
- ✓ Easily Accommodates Changes or Additions!
- ✓ No Specialized Electrical Knowledge Necessary
- ✓ Eliminates Hundreds of Feet of Wiring!
- ✓ Programmable for Custom Functions!

¹Versus other universal wiring systems.

The Infinitybox base system can be used in conjunction with any Infinitybox accessory module. Control upto 20 electrical circuits with this system alone. Pre-configured to control ignition, headlights, parking lights, high beams, horn, electric fans, self-cancelling turn signals, hazard lights, electric fuel pump and brake lamps. Includes one MASTERCELL and two POWERCELL units, universal wiring harnesses and primary fuses.

Basic Kit		
MP50101	3-cell	1552.99 kit
Basic Kit w/inLINK		
MP50102	3-cell	1790.99 kit
Basic Kit w/inLINK & inRESERVE		
MP50103	3-cell	1996.99 kit
Basic Kit w/inLINK, inRESERVE, inTOUCH MAX		
MP50116	3-cell	2409.99 kit

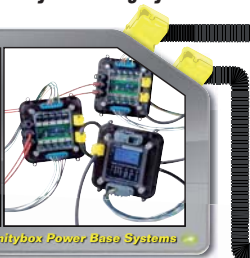

Infinitybox Power Base Systems



Featured on our 1972

TWISTED
Duster!

Connect with your Car!

The Infinitybox MASTERCELL supports various interfaces, such as stock or aftermarket switches, remote key fobs, or in-car touchscreen controls...

Even connect to your vehicle with your iPad, iPhone, or iPod!



For videos, instruction manuals and more information about Infinitybox Wiring Multiplex Systems:

Scan this Code or Visit
www.classicindustries.com/Infinityboxwiring



Infinitybox Accessory Modules

inLink Remote Control



inLINK Key Fob Control Module

Control up to 16 different functions with the inLINK 4-button key fob. Consolidate vehicle security, remote lighting, dooropening, and similar systems and control them with an encoded signal from 100 feet away. Features a simple plug-and-play installation. Includes 2 key fobs, batteries and installation guide.
 MP50105 inLINK control module..... 237.99 kit

Smart Phone Control



inTOUCH Mobile for iPod, iPhone, or iPad

Unlock doors, turn on lights, roll down windows – control virtually any electrical accessory through an encrypted Wi-Fi connection with this simple user interface for your iPhone, iPad, or iPod touch. Includes mobile radio interface card and operating instructions. Mobile app requires iOS 3.1.3 or newer.
 MP50106 inTOUCH for Apple devices... 401.99 ea

Touch to Control your Vehicle!



inTOUCH MAX 7" Touch Screen

The inTOUCH MAX 7" touch screen gives you complete control of your vehicle accessories and access expanded diagnostics with just one simple connection to the MASTERCELL. In addition to virtually eliminating the need for hard-mounted switches in the car, you can also eliminate the need for ignition keys with its built in password security system. Includes touch screen, MASTERCELL interface cable, and installation guide.
 MP50107 7" touch screen interface... 1723.99 kit

Need More Circuits?



Add-On POWERCELL

Looking to add more accessories with your Infinitybox system? Add up to 10 more circuits with an additional POWERCELL. Up to five POWERCELL units can be controlled by the MASTERCELL for a total number of 50 output circuits. Includes wiring, connectors and installation guide.
 MP50108 POWERCELL control unit. 516.99 ea

Note: No further discounts apply on any of the listed items.



Add Power/Ground Reversing



inMOTION Motor Controller

Add up to 5 electrical accessories that require power and ground reversing, such as window motors, lock solenoids, and convertible tops. Uses any type of switch or input and allows for options like "express down" power windows. Also features intelligent technology that allows the cell to learn the normal operation of every connected component and reacts if an unusual event occurs to prevent damage from obstructions or binding mechanisms.
 MP50109 inMOTION motor controller.. 516.99 kit

Program Custom Functions!



inCODE Programming Module

Now you can add custom features like "theater dimming" interior lights, or delayed-off headlights, even after your system has been installed. The Infinitybox system supports custom input and output personalities. With the inCODE Programming Module, you download custom-configured programs from your personal computer and import it directly to your MASTERCELL or POWERCELL in less than 90 seconds.
 MP50110 inCODE programmer..... 332.99 ea

Add Dash Lighting



inDASH MAX Dash Lighting Controller

The inDASH MAX is a compact module that functions much like a POWERCELL, but is designed specifically to activate LEDs or incandescent bulbs in your gauge cluster based on commands sent from the MASTERCELL when turn signals, parking light switches, or high-beams are activated.
 MP50111 inDASH MAX dash lighting... 320.99 ea

VintageAir Climate Control



inVIRONMENT Vintage Air® Controller

Asimpletwo cable hookup with the Vintage Air Gen-IV® allows truly seamless integration with the Infinitybox system. Gain complete control of your air-conditioning with Infinitybox through your choice of buttons, the inTOUCH MAX touch screen or with your Apple device.

Note: Product shown using inTouch Max interface, sold separately.
 MP50112 Vintage Air Gen-IV module 435.99 ea

Add Wiring Accessories



inRESERVE Battery Monitoring

Constantly monitor your battery while your car is parked with inRESERVE! If voltage gets too low, inRESERVE disconnects the battery to preserve remaining voltage. The system also allows you to disconnect and reconnect the battery at the touch of a button. Includes exclusive Infinitybox battery monitoring software.
 MP50114 inRESERVE module 205.99 kit

Mopar Model Identification

1960-76 A-Body



1960-62 Plymouth Valiant

Body Styles:

2-door sedan 2-door hardtop
4-door sedan 4-door wagon

Trim Levels:

V 100 V 200 Signet

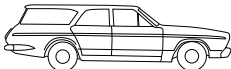

1963-66 Plymouth Valiant

Body Styles:

2-door sedan 2-door convertible
2-door hardtop 4-door sedan
4-door suburban 4-door wagon

Trim Levels:

V 100 V 200 Signet



1967-76 Plymouth Valiant

Body Styles:

2-door sedan 4-door sedan

Trim Levels:

100 200 Signet Scamp

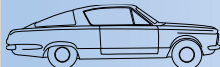

1964-66 Plymouth Barracuda

Body Styles:

2-door fastback

Trim Levels:

Barracuda

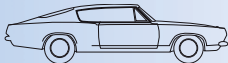

1967-69 Barracuda Fastback

Body Styles:

2-door fastback 2-door convertible
2-door notchback

Trim Levels:

Barracuda Super Stock 'Cuda

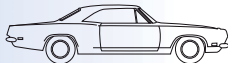

1967-69 Barracuda Notchback

Body Styles:

2-door fastback 2-door convertible
2-door notchback

Trim Levels:

Barracuda Super Stock 'Cuda

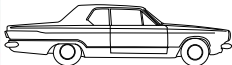

1963-66 Dodge Dart

Body Styles:

2-door sedan 2-door hardtop
2-door convertible 4-door sedan
4-door wagon

Trim Levels:

170 270 GT

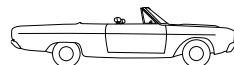

1967-69 Dodge Dart

Body Styles:

2-door sedan 2-door hardtop
2-door convertible 4-door sedan

Trim Levels:

Standard 270 GT
GTS Super Stock

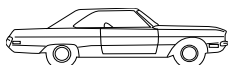

1970-76 Dodge Dart

Body Styles:

2-door hardtop 2-door coupe
4-door sedan

Trim Levels:

Standard Custom Swinger
Swinger 340



1971-72 Dodge Demon

Body Styles:

2-door sport coupe

Trim Levels:

Demon Demon 340 Sizzler



1973-76 Dodge Dart Sport

Body Styles:

2-door sport coupe

Trim Levels:

Dart Sport 340 Dart Sport 360
Dart Sport Hang Ten

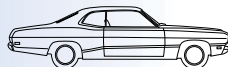

1970-76 Plymouth Duster

Body Styles:

2-door sport coupe

Trim Levels:

Duster Duster 340 Twister

Mopar Model Identification

1962-65 B-Body



1962 Dodge Dart

Body Styles:

- 2-door sedan
- 2-door hardtop
- 2-door convertible
- 4-door sedan
- 4-door hardtop
- 4-door wagon

Trim Levels:

- Dart
- Dart 300
- Dart 440

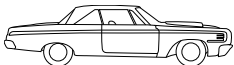

1962-65 Dodge Polara, Coronet 330 & 440

Body Styles:

- 2-door sedan
- 2-door hardtop
- 2-door convertible
- 4-door sedan
- 4-door hardtop
- 4-door wagon

Trim Levels:

- Polara
- Polara 500
- 440
- Coronet 330
- Coronet
- Coronet 440



1962-64 Plymouth Fury & Sport Fury

Body Styles:

- 2-door hardtop
- 2-door convertible
- 4-door sedan
- 4-door hardtop
- 4-door wagon

Trim Levels:

- Fury
- Sport Fury

1966-74 Dodge B-Body

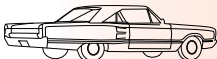

1966-67 Dodge Coronet

Body Styles:

- 2-door sedan
- 2-door hardtop
- 2-door convertible
- 4-door sedan
- 4-door wagon

Trim Levels:

- Coronet
- Coronet 440
- Deluxe
- Hemi-Charger
- Coronet 500
- R/T

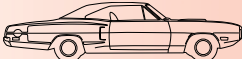

1966-70 Coronet & Super Bee

Body Styles:

- 2-door coupe
- 2-door hardtop
- 2-door convertible
- 4-door sedan
- 4-door wagon

Trim Levels:

- Deluxe
- Coronet 440
- R/T
- Super Bee
- Coronet 500



1971-74 Coronet

Body Styles:

- 4-door wagon

Trim Levels:

- Coronet
- Custom
- Brougham
- Crestwood



1966-67 Dodge Charger

Body Styles:

- 2-door fastback

Trim Levels:

- Charger

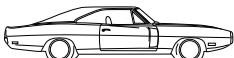

1966-70 Charger

Body Styles:

- 2-door hardtop

Trim Levels:

- Charger
- R/T
- Charger 500
- SE
- Daytona

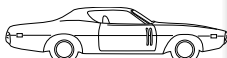

1971-74 Charger & Super Bee

Body Styles:

- 2-door hardtop
- 2-door fastback

Trim Levels:

- Charger
- Charger SE
- Charger R/T
- Super Bee
- Charger 500

1969-70 Winged B-Body

1969-70 Mopar Winged Warriors

1969 Dodge Charger Daytona

- 503 Built
- Top Speed: 200+ MPH (race trim)
- Available Engines: 440, 426 Hemi
- Available Transmissions: A-727, A-833
- Cool Fact: Functional fender scoops

1970 Plymouth Road Runner Superbird

- 1,935 Built
- Available Engines: 440-4, 440-6, 426 Hemi
- Available Transmissions: A-727, A-833
- Cool Fact: Most aero parts differ from Daytona aero parts



1969 Dodge Charger Daytona

Body Styles:

- 2-door hardtop

Trim Levels:

- Daytona



1970 Plymouth Road Runner Superbird

Body Styles:

- 2-door hardtop

Trim Levels:

- Superbird

Mopar Model Identification

1962-74 Plymouth B-Body

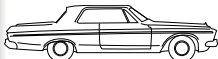

1962-65 Satellite, Belvedere & Savoy

Body Styles:

2-door sedan
4-door sedan 2-door hardtop
4-door wagon

Trim Levels:

Belvedere Savoy Satellite
Belvedere I Belvedere II



1966-67 Belvedere & Satellite

Body Styles:

2-door sedan 2-door hardtop
2-door convertible 4-door sedan
4-door wagon

Trim Levels:

Belvedere Satellite
Belvedere I Belvedere II GTX

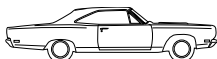

1968-69 Belvedere & Satellite

Body Styles:

2-door hardtop 2-door sedan
2-door convertible 4-door sedan
4-door wagon

Trim Levels:

Belvedere Satellite Sport Satellite
Road Runner GTX

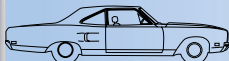

1970 Plymouth Belvedere & Satellite

Body Styles:

2-door sedan 2-door hardtop
2-door convertible 4-door sedan
4-door wagon

Trim Levels:

Belvedere Satellite Sport Satellite
Road Runner GTX

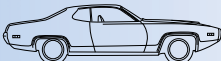

1971-72 Road Runner & Satellite

Body Styles:

2-door sedan 2-door hardtop
4-door sedan 4-door wagon

Trim Levels:

Satellite Road Runner GTX
Regent Brougham Satellite Sebring Plus

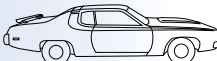

1973-74 Road Runner & Satellite

Body Styles:

2-door sedan 2-door hardtop
4-door sedan 4-door wagon

Trim Levels:

Satellite Road Runner Road Runner GTX
Custom Regent Satellite Sebring Plus

1970-74 E-Body

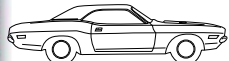

1970-74 Dodge Challenger

Body Styles:

2-door hardtop 2-door convertible

Trim Levels:

Challenger R/T T/A
Rallye

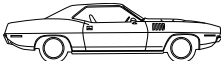

1970-74 Plymouth Barracuda Hardtop

Body Styles:

2-door hardtop 2-door convertible

Trim Levels:

Barracuda Gran Coupe AAR
'Cuda

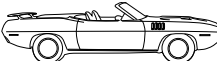

1970-71 Plymouth Barracuda Convertible

Body Styles:

2-door hardtop 2-door convertible

Trim Levels:

Barracuda Gran Coupe AAR
'Cuda

A, B & E-Body Original Base Prices

A-Body Models

1964-66 Plymouth Barracuda		
1964 Barracuda	6 cylinder	\$2,496
1965 Barracuda	6 cylinder	\$2,586
1966 Barracuda	6 cylinder	\$2,637
1968-71 Dodge Dart & Demon		
1968 Dart GTS	340 V8	\$3,189
1969 Dart Swinger 340	340 V8	\$2,857
1970 Dart Swinger 340	340 V8	\$2,808
1971 Demon 340	340 V8	\$2,721

Plymouth B-Body Models

1966-72 Plymouth Satellite, GTX & Road Runner Models		
1966 Satellite	Hemi V8	\$4,100
1967 GTX	440 V8	\$3,178
1968 Road Runner	383 V8	\$2,896
1969 Road Runner	383 V8	\$2,945
1970 Road Runner	383 V8	\$2,896
1971 Road Runner	383 V8	\$3,147
1972 Road Runner	340 V8	\$3,080

Dodge B-Body Models

1967-71 Dodge Charger & Charger Daytona		
1967 Charger	318 V8	\$3,128
1968 Charger R/T	440 V8	\$3,480
1969 Charger R/T	440 V8	\$3,592
1969 Charger Daytona	440 V8	\$3,993
1970 Charger R/T	440 V8	\$3,711
1971 Charger R/T	440 V8	\$3,777

E-Body Models

1970-72 Challenger		
1970 Challenger R/T	383 V8	\$3,266
1971 Challenger R/T	383 V8	\$3,273
1972 Challenger Rallye	318 V8	\$3,082
1970-74 'Cuda		
1970 AAR 'Cuda	340 6-BBL V8	\$3,966
1971 'Cuda	383 V8	\$3,144
1972 'Cuda	340 V8	\$3,105
1973 'Cuda	340 V8	\$3,105
1973 'Cuda	360 V8	\$3,252

Mopar Production Figures

The Dodge and Plymouth passenger cars manufactured by the Chrysler corporation were some of the most popular and iconic vehicles produced during the Muscle Car era as shown by the production figures listed here. In an attempt to show the number of vehicles produced during these years, we have listed the specific model figures as closely as possible. The breakdown is

1960-76 A-Body		
1960	Valiant	194292
1961	Valiant	143078
1962	Valiant	157294
1963	Dart	34227
1963	Valiant	225156
1964	Barracuda	23433
1964	Dart	49830
1964	Valiant	227585
1965	Barracuda	64596
1965	Dart	45118
1965	Valiant	167153
1966	Barracuda	38029
1966	Dart	30041
1966	Valiant	138137
1967	Barracuda	62534
1967	Dart	38225
1967	Valiant	108969
1968	Barracuda	45412
1968	Dart	43127
1968	Valiant	110795
1969	Barracuda	31987
1969	Dart	33068
1969	Valiant	107218
1970	Dart	133668
1970	Valiant/Duster	268002
1971	Dart/Demon	123864
1971	Valiant/Duster	277391
1972	Dart/Demon	147567
1972	Valiant/Duster	330393
1973	Dart/Dart Sport	134979
1973	Valiant/Duster	380597
1974	Dart/Dart Sport	109348
1974	Valiant/Duster	459083
1975	Dart/Dart Sport	55842
1975	Valiant/Duster	211267
1976	Dart/Dart Sport	14801
1976	Valiant/Duster	85686

1962-76 B-Body		
1962	Fury	43019
1962	Polaro	12268
1963	Fury	84822
1963	Polaro	7256
1964	Fury	115771
1964	Polaro	17787
1965	Belvedere	139334
1965	Satellite	25201
1966	Belvedere	151124
1966	Charger	37344
1966	Coronet	250842
1966	Satellite	38158
1967	Belvedere	115702
1967	Charger	15788
1967	Coronet	179583
1967	GTX	12115
1967	Satellite	32378

not specific to body style or options. Other information on specific vehicles and model years and may be found in some of the literature offered by Classic Industries in this catalog. The information provided in the chart is believed to be correct. However, the accuracy of these figures has not been verified by the factory or any other source.

1968	Belvedere	41898
1968	Charger	92590
1968	Coronet	213344
1968	GTX	18940
1968	Road Runner	44599
1968	Satellite	136136
1969	Belvedere	27015
1969	Charger	85680
1969	Coronet	195000
1969	GTX	15602
1969	Road Runner	84420
1969	Satellite	114157
1970	Belvedere	24246
1970	Charger	46315
1970	Coronet	114548
1970	GTX	7748
1970	Road Runner	41484
1970	Satellite	82654
1971	Charger	58560
1971	Coronet	77728
1971	GTX	2942
1971	Road Runner	14218
1971	Satellite	129867
1972	Charger	75594
1972	Coronet	66348
1972	Road Runner	7628
1972	Satellite	137325
1973	Charger	119318
1973	Coronet	87533
1973	Road Runner	19056
1973	Satellite	199148
1974	Charger	74376
1974	Coronet	60728
1974	Road Runner	11555
1974	Satellite	138408
1975	Charger	30812
1975	Coronet	84498
1975	Road Runner	7183
1976	Charger	65900
1976	Coronet	41163

1970-74 E-Body		
1970	Barracuda	35026
1970	Challenger	83103
1970	Cuda	18815
1971	Barracuda	12088
1971	Challenger	30004
1971	Cuda	6602
1972	Barracuda	10622
1972	Challenger	18535
1972	Cuda	7828
1973	Barracuda	11587
1973	Challenger	32596
1973	Cuda	10626
1974	Barracuda	6745
1974	Challenger	16437
1974	Cuda	4989

1960-76 A-Body Light Bulb Chart

This application chart is intended for use as an identification guide only. To ensure a correct replacement, always check the bulb from your vehicle before ordering. Bulbs shown above have Classic Industries part numbers associated with them. *Note: 1034A and 1157A are amber colored bulbs.*

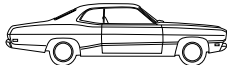
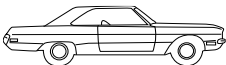
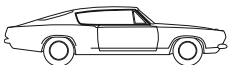

	1960	1961	1962	1963	1964	1965	1966	1967	1968	1969	1970	1971	1972	1973	1974	1975	1976
Sealed Beam Headlamp	4000, T5001	4000, T5001	4000, T5001	6014	6014	6014	6014	6014	6014	6014	6014	6014	6014	6014	6014	6014	6014
AC/Heater Control	--	--	--	--	--	--	1893 ²	--	1445	1445	1445	1445	1445	1892	1892	1892	1892
Ash Tray	--	--	--	--	--	--	57	--	1445	1445	1445	1892	161	161	161	161	161
Back Up	1073B	1073B	1073B	1073B	1073B	1073B	1073B	1141 ³	1073B	1156	1156	1156	1156	1156	1156	1156	1156
Brake System Warning Light	57	90 ² , 53 ²	--	--	--	--	--	57	57	158 ² , 57 ²	158 ² , 57 ²	158 ² , 57 ²	158	158	158	158	158
Clock	1816	57	--	--	--	--	57	--	--	--	--	--	--	--	--	--	--
Courtesy, Door and/or Pocket	1004	90	--	--	--	--	90	90	89, 90	B2112, 89, 90	89	89	89	89	89	89	89
Dome	1004	1004	1004	1004	1004	1004	1004	1004	1004	1004	1004	1004	1004	1004	1004	1004	1004
Emergency Flasher	--	--	--	--	--	57	57	--	--	--	--	--	--	--	--	--	--
Fender Mounted Turn Signal	--	--	--	--	--	--	330	330 ² , 1892 ²	330	330	330	330	330	161	--	168	168
Front Park Lamp	1034	1034	1034	1034	1034	1034	1034A	1034A ² , 1034 ²	1034A ² , 1034 ²	1157A	1157	1157A	1157A	1157A	1157A	1157A	1157, 1157A
Gear Selector w/ Console	--	--	--	--	--	53	57	57	57	57	57	57	--	--	--	--	57
Column Gear Selector	--	--	--	53	53	1445	1445	1445	1445	1445, 53	161	161	161	161	161	161	161
Glove Box	57	1891	1891	1891	1891	1891	1891	1891	1891	1891	1891	1891	1891	1891	1891	1891	1891
Park Brake	--	--	90	57	57	57	57	57	--	--	--	--	--	--	--	--	--
Rr Wndw Defrost	--	--	--	--	--	--	--	--	--	--	--	--	--	--	--	53	53
High Beam Indicator	--	--	57	57	57	158 ² , 57 ²	158	158	158	158	158	158	158	158	158	158	158
Ignition Switch	57	--	--	--	--	--	158	158	--	1445	1445	1445	1445	1445	1445	1445	1445
Instrument Cluster	57	57	57	57	57	158 ² , 57 ²	158	158	158	158	158	158	158	158	158	158	158
License	B67	B67	B67	B67	B67	B67	B67	B67	B67	B67	B67	B67	168	168	168	168	168
Map	1004	1004	1004	90	90	90	90	--	89	--	89	89	89	89	89	89	89
Oil Pressure Indicator	--	--	57	57	57	158 ² , 57 ²	158	57 ² , 158 ²	158	158	158	158	158	158	158	158	158
Radio	1816 ² , 57 ²	1891	1892	53	53	1893	1893	1893	1816	1816	--	--	--	--	1893	1893	1893
Radio w/Tape	--	--	--	--	--	--	--	--	--	--	1816	1816	1816	1816 ² , 1893 ²	--	--	--
4 Speed Reverse	--	--	--	--	--	--	--	--	--	53	53	53	53	53	53	53	161
Seat Belt Indicator	--	--	--	--	--	--	--	--	--	--	53	53	1445	1445	1445	1445	1445
Side Marker	--	--	--	--	--	--	--	--	1895	--	--	1895	194	168	168	168	168
Tachometer	--	--	--	--	--	--	57 ²	1816 ²	1816	² / ₁	--	--	--	--	--	--	--
Tail, Stop, Turn Signal	1034	1034	1034	1034	1034	1034 ² , 1156 ²	1034	1034	1034	1157	1157	1157	1157	1157	1157	1157	1157
Trunk Lamp	1003	1004	1003	1003	1004	1004	1004	1004	1004	1004	1004	1004	1004	1004	1004	1004	1004
Turn Signal Indicator	57	57	57	57	57	158 ² , 57 ²	158	158	158	158	--	158	158	158	158	158	--
Under Hood	--	1004	1003	1003	1004	1004	1004	1004	1004	1004	1004	1004	1004	1004	1004	1004	--

Bulb Chart Notes:
² Dodge Models

³ Plymouth Models

⁴ Included in Instrument Cluster Illumination

² Dart Wagon Models Used Bulb #B67

³ Models with Console Tach

⁴ Tail Lamp Only

1960-69 B-Body Light Bulb Chart

This application chart is intended for use as an identification guide only. To ensure a correct replacement, always check the bulb from your vehicle before

ordering. Bulbs shown above have Classic Industries part numbers associated with them. *Note: 1034A and 1157A are amber colored bulbs.*

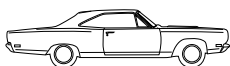
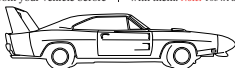
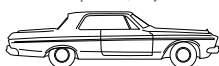

	1960	1961	1962	1963	1964	1965	1966	1967 ^a	1967 ^b	1968	1969 ^c	1969 ^d
Sealed Beam - 5-3/4"	4000, T5001	4000, T5001	4000, T5001	4000, T5001	4000, T5001	4000, T5001	4000, T5001	4000, T5001	4000, T5001	4000, T5001	4000, T5001	4000, T5001
Sealed Beam - 7"	--	--	--	--	--	6014	6014	--	--	--	--	--
AC/Heater Control	--	--	1816	1892 ^e , * ^d	* ^d , 1892 ^d	1892 ^d	1893	1893 ^e , 1445 ^d	EL	1892	1892	1892
Ash Tray	--	--	--	--	--	--	57	--	--	1445	1892	53
Auto Pilot	--	--	--	--	--	--	57	1893	1893	--	--	--
Back Up	1073B	1073B	1073B	1073B	1073B	1073B	1073B	1141 ^d	1141 ^d	1073B ^f	1156	1156
Brake System Warning Lamp	57	90	53	--	--	--	--	257	257	158	158	57
Clock	1816	57	57	*	--	--	57 ^e , * ^d	57 ^e , * ^d	57	57	57	--
Courtesy, Door and/or Pocket	1004	90	--	--	--	--	--	--	--	--	89	89
Dome	1004	1004	1004	1004	1004	1004	1004	1004	1004	1004	1004	1004
Door/Pocket Panel/Reading Light	--	--	--	--	--	--	--	90	90	90	90	90
Emergency Flasher	--	--	--	--	--	57	57	--	--	--	--	--
Fender Mounted Turn Signal	--	--	--	--	--	--	330	330 ^e , 1893 ^d	330	330	330	1816
Front Park Lamp	1034	1034	1034	1034	1034	1034A ^e , 1034 ^d	1034A	1034A ^e , 1034 ^d	1034A ^e , 1034 ^d	1034	1157	1816
Gear Selector w/ Console	--	--	--	--	--	57	57	57	53	57	1445	1445
Column Gear Selector	--	--	--	53	* ^d , 53 ^d	1445	1445	1445	1445	57	57	57
Glove Box	57	1891	1891	1891	1891	1891	1891	1891	1891	1891	1891	1891
High Beam Indicator	--	--	57	57	57	158	158	158	57	158	158	57
Ignition Switch	57	--	--	--	--	--	158	--	--	1445	1445	1445
Instrument Cluster	57	57	57	57	57	57 ^e , 158 ^d	158	158	EL	158	158	57, 158
License Plate	B67	B67	B67	B67	B67	B67	B67	B67	B67	B67	B67	B67
Map	1004	1004	1004	90	90	90	90	90	90	90	90	90
Oil Pressure Indicator	--	--	57	57	57	158	158	57 ^e , 158 ^d	--	158	158	--
Park Brake	--	--	57	57	57	57	57	57 ^e , 257 ^d	257	--	--	--
Radio	57 ^e , 1816 ^e	1892	1892	1892	1892 ^e , 57 ^e	1893	1893	1893	EL	1816	1816	1816
Radio w/Tape	--	--	--	--	--	--	--	--	--	--	B1815	--
4 Speed Reverse	--	--	--	--	--	--	--	--	--	--	53	53
Tachometer	--	--	--	--	--	--	57 ^e	1816 ^e	EL	57	57	--
Tail, Stop, Turn Signal	1034	1034	1034	1034	1034	1034	1034	1034, B67 ^f	1034	1034	1157, 1156 ^e	1157, 1156 ^e
Trunk	1003	1004	1003	1003	1004	1004	1004	1004	1004	1004	1004	1004
Turn Signal Indicator	57	57	57	57	57	158	158	158	57	158	158	57
Under Hood	--	1004	1003	1003	1003	1004	1004	1004	1004	1004	1004	--

Bulb Chart Notes:

- ^a Except Charger
- ^b Charger Only
- ^c Dodge Models
- ^d With AM Radio
- ^e With FM Radio
- ^f Plymouth Models
- * Charger Rallye Models
- ^g Included in Instrument Cluster Illumination

- ¹ Wagon Models Use Bulb #1141
- ² Models with Console Tach
- ³ Tail Lamp Only
- ⁴ With Standard Column
- ⁵ With Tilt Column
- EL: Electroluminescent Lighting



1970-76 B-Body Light Bulb Chart

This application chart is intended for use as an identification guide only. To ensure a correct replacement, always check the bulb from your vehicle before

ordering. Bulbs shown above have Classic Industries part numbers associated with them. *Note: 1034A and 1157A are amber colored bulbs.*

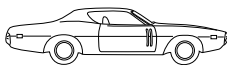

	1970 ^a	1970 ^b	1971	1972	1972 ^c	1973	1973 ^d	1974	1974 ^e	1975	1976
Sealed Beam - 5-3/4"	4000, T5001	4000, T5001	4000, T5001	4000, T5001	4000, T5001	4000, T5001	4000, T5001	4000, T5001	4000, T5001	--	--
Sealed Beam - 7"	--	--	--	--	--	--	--	--	--	6014	6014
AC/Heater Control	1892	1892	53	53	53	1892	1892	1892	1892	B363	B363
Ash Tray	1445	1445	1445	1445	1445	161	161	161	161	161	161
Back Up	1156	1156	1156	1141, 1156	1156	1156	1156	1156	1156	1156	1156
Brake System Warning Lamp	158	57	158, 57 ^a	158	57	158	57	158	57	158	--
Cassette Tape Deck	--	--	--	--	--	1891	1891	--	--	--	--
Clock	57	--	--	--	--	--	--	--	--	158	158
Courtesy, Door and/or Pocket	89	89	562	562	562	562	562	562	562	562	562
Dome	1004	1004	1004	1004	1004	1004	1004	1004	1004	1004	1004
Door Ajar Indicator	--	--	1892	1892	1892	1892	1892	--	--	--	57
Door/Pocket Panel/Reading Light	90	90	--	--	--	--	--	--	--	--	--
Fender Mounted Turn Signal	330	330	330	330	330	161	161	168	168	168	168
Front Park Lamp	1157	1157	1157A, 1157	1157A, 1157	1157A, 1157	1157	1157A	1157A	1157A	1157A	1157, 1157A
Gear Selector w/ Console	57	57	57	57	57	57	57	57	57	57	57
Column Gear Selector	161	161	161	161	161	161	161	161	161	158 ^b , 1445 ^b	161
Glove Box	1891	1891	1891	1891	1891	1891	1891	1891	1891	1891	1891
Rr Wndw Defroster	--	--	--	--	--	--	--	161	161	161	74
High Beam Indicator	158	57	158, 57 ^a	158	57	158	57	158	57	158	--
Ignition Switch	1445	1445	1445	1445	1445	1445	1445	1445	1445	1445	1445
Instrument Cluster	158	57, 158	158, 57 ^a	158	57	158	57	158	57	158	158
License Plate	B67	B67	B67	B67	B67	B67	B67	B67	B67	B67	168
Low Fuel Indicator	--	--	1892	1892	1892	--	--	--	--	--	--
Map	90	90	562	562	562	562	562	562	562	562	562
Oil Pressure Indicator	158	--	158	158	--	158	--	158	--	158	--
Radio	1816	1816	B1815	B1815	B1815	1816	1816	1816	1816	168	168
Radio w/Tape	B1815	--	1816	1816	1816	1816	1816	--	--	--	--
4 Speed Reverse	53	53	53	53	53	53	53	53	53	53	--
Seat Belt Indicator	53	53	1892	1892	1892	1892 ^b , 161 ^f	1892 ^b , 161 ^f	1816	1816	158	--
Side Marker	--	--	194	194	194	168	168	168	168	168	168
Stereo Indicator	--	--	1445	1445	1445	1445	1445	1445	1445	74	74
Switch Lighting	--	--	1892	1892	1892	161	161	--	--	--	--
Tachometer	57	--	--	--	--	--	--	--	--	--	--
Tail, Stop, Turn Signal	1157	1157, 1156 ^g	1157 ^g	1157	1157	1157	1157	1157	1157	1157	1157
Trunk	1004	1004	1003	1003, 1004	1003, 1004	1003, 1004	1003, 1004	1003, 1004	1003, 1004	1003, 1004	1003
Turn Signal Indicator	158	158	158, 57 ^a	158	57	158	57	158	57	158	--
Under Hood	1004	1004	1003	1003, 1004	1003, 1004	1003, 1004	1003, 1004	1003, 1004	1003, 1004	1003, 1004	--

Bulb Chart Notes:
¹ Except Charger

^e With AM Radio

^c Charger Rallye Models

² Models with Console Tach

^g With Tilt Column

² Charger Only

^f With FM Radio

^{*} Included in Instrument Cluster Illumination

³ Tail Lamp Only

EL: Electroluminescent

³ Plymouth Models

⁴ Standard Column

⁴ Wagon Models Use Bulb #1141

⁵ With Standard Column

Lighting

ORDER FORMS & INDEX

1970-74 E-Body Light Bulb Chart



	1970	1971	1972	1973	1974
Sealed Beam - 5-3/4"	4000, T5001	4000, T5001	4000, T5001	4000, T5001	4000, T5001
Sealed Beam - 7"		--	6014	6014	6014
AC/Heater Control	B1815	B1815	B1815	161 ^D , B1815 ^D	161
Ash Tray	1445	1445	1445	161	161
Back Up	1156	1156	1156	1156	--
Brake System Warning	--	57	1893 ^D , 57 ^D	57, 1895 ^D	57, 1895 ^D
Cassette Tape Deck	--	--	--	1891	--
Courtesy, Door/Pocket	90	89	89	89	89
Dome	1004	B2112, 1004	B2112, 1004	B2112, 1004	1004
Door Ajar Indicator	1892	1892	1892	1892	--
Fender Mounted Turn Signal	330	330	330	161	168
Front Park Lamp	1157	1157A	1157	1157A	1157A
Gear Selector w/Console	57	57	57	57	57
Column Gear Selector	161	161	161	161	161
Glove Compartment	1891	1891	1891	1891	1891
High Beam Indicator	57	57	1893 ^D , 57 ^D	1895 ^D , 57 ^D	57, 1895 ^D
Ignition Switch	1445	1445	1445	1445	1445
Instrument Cluster	1816, 1893 ^D	1816, 1893 ^D	1816, 1893 ^D	1816, 1893 ^D	1816, 1893 ^D
License	B67	B67	B67	B67	B67
Low Fuel Indicator	1892	1892	1892	--	--
Map	89	89	89	89	89
Oil Pressure Indicator	57	57	57	57	57
Pocket Panel Lamp	--	90	--	--	--
Radio	B1815	B1815	B1815	B1815 ^D , 1816 ^D	B1815, 1816
Radio w/Tape	1816	1816	1816	1816	--
4 Speed Reverse	53	53	53	53	53
Seat Belt Indicator	53, 1892 ^D	53, 1892	--	--	--
Side Marker	--	1895	194	168	168
Stereo Indicator	1445	1445	1445	1445	1445
Switch Lighting	--	1445	1445	--	--
Switch Courtesy	--	--	1445	161	161
Tail, Stop, Turn Signal	1157	1157	1157	1157	1157
Trunk	1004	1003	1003, 1004	1003, 1004	1003, 1004
Turn Signal Indicator	1004, 57 ^D	57	1893, 57 ^D	57, 1895 ^D	57, 1895 ^D
Under Hood	--	1003	1003, 1004	1003, 1004	1003, 1004

Bulb Chart Notes:

- ^D Dodge Models
- ^P Plymouth Models
- ^A All Rally Models

Comprehensive Light Bulb Specifications

Below is a comprehensive guide to the correct light bulbs for your Mopar. Included is the industry standard part number, the Classic Industries' part number, the base style, voltage output in candle-power and price.

Note: Base style suffix "S" is single contact; base style suffix "D" is double contact; base style suffix "I" indicates an indexed bulb.



Part Number	Bulb Style	Base Style	Voltage	Output
53	G-3	1/2 BA9S	12	1cp
57	G-4	1/2 BA9S	12	2cp
74	T-1	3/4 Mini Wedge	12	7cp
89	G-6	BA15S	12	6cp
90	G-6	BA15D	12	6cp
158	T-3	1/4 Wedge	12	2cp
161	T-3	1/4 Wedge	12	1cp
168	T-3	1/4 Wedge	12	3cp
194	T-3	1/4 Wedge	12	2cp
257	G-4	1/2 BA9S	12	1.6cp
562	T-3	Rigid Loop	12	6cp
1003	B-6	BA15S	12	16cp
1004	B-6	BA15D	12	15cp
1034	S-8	BAY15Di	12	32/3cp
1141	S-8	BA15S	12	21cp
1156	S-8	BA15S	12	32cp
1157	S-8	BAY15Di	12	32/3cp
1445	G-3	1/2 BA9S	12	7cp
1816	T-3	1/4 BA9S	12	3cp
1891	T-3	1/4 BA9S	12	2cp
1892	T-3	1/4 BA9S	12	7.5cp
1893	T-3	1/4 BA9S	12	2cp
1895	G-4	1/2 BA9S	12	2cp
4000	Headlamp	5-3/4" Sealed	12	Low Beam
5001	Headlamp	5-3/4" Sealed	12	High Beam
6014	Headlamp	7" Sealed	12	Low/High Beam
1034A	S-8	BAY15Di	12	23cp
1073B	S-8	BA15S	12	32cp
1157A	S-8	BAY15Di	12	24/23cp
B1815	T-3	1/4 BA9S	14	1.4cp
B2122	T-3	Double End Cap	12	6cp
B330	T-3	1/4 Midget Flange	12	5cp
B363	G-3	1/2 BA9S	14	2cp
B67	G-6	BA15S	12	4cp

Four Ways to Order!



ORDERING BY PHONE TOLL FREE 800-854-1280

In the continental United States, Hawaii and Alaska. Outside the U.S call 714.847.6887.

Mon-Fri 8:00-5:00 Sat 10:00-3:00, P.S.T.
(Closed Sundays and holidays)

Information you'll need when ordering by Phone:

Customer Number

Found on back cover of your catalog above your name, this number allows Classic Industries® to quickly access your information. If you do not have a customer number, a new one will be given to you when placing your order.

Billing and Shipping Address

Please have the billing and shipping address available. Credit card orders are verified by name and address before shipping. Your order can be shipped to a different address, provided the cardholder's name and address match the credit card used. You may be asked to contact your credit card company to have the shipping address added to your account.

Year and Model of Vehicle

To provide the best possible service, we may require the year and model of your vehicle. This helps verify that the parts you order are correct for your car.

Part Numbers

All Classic Industries® products are listed with a part number. If possible, please have the part numbers of the products you're ordering available before calling to make the ordering process faster and more convenient.



ON-LINE ORDERING www.classicindustries.com

Classic Industries® offers on-line ordering directly through our website. Log on to classicindustries.com and order on-line. On-line ordering is available 24 hours a day 7 days a week for your convenience.



ORDERING BY MAIL Mail Your Completed Order Form To:

Classic Industries®
18460 Gothard St.
Huntington Beach, CA 92648
Attention: Order Dept.



ORDERING BY FAX TOLL FREE 800-300-3081

In the continental United States, Hawaii and Alaska. Outside the U.S call 714.847.6887.

Important: For assistance with your order form, see page entitled "How To Fill Out Your Order Form".

Service Excellence From the Restoration Leaders!

You No Longer Have To:

- ✗ Pay excessive fees to protect your merchandise
- ✗ Contact the carrier yourself
- ✗ File a damage claim yourself to have the carrier inspect the damaged items
- ✗ Send the damaged items back at your expense

With Classic Industries® the worry is eliminated!

PROCEDURE FOR RETURNING SHIPPING DAMAGES

We handle the claim so you don't have to! If any part you receive is damaged during shipping and handling, simply contact our customer service department toll-free at 800.854.1280 within two business days.

After verifying the damage, Classic Industries will issue a pick up call tag through the carrier that shipped the products. The carrier will pick up the damaged goods from your address and return them to us at no expense to you. After the product has been inspected, our customer service department will send a replacement part.

In order to ensure replacement of damaged products, please return items in their original box and packaging. Failure to do so may result in the claim being denied. Someone must be available at the pickup address to supply the damaged products when the carrier arrives. If the carrier is unable to pick up the products for any reason, the customer may be required to return the products at their expense.

Note: Some products are excluded from damage call tag pick up. Call a customer service representative for information about products that are not eligible.

ENJOY THE BENEFITS!

Money Back Guarantee



At Classic Industries®, we take pride in the quality of the products we offer and back it up with a 100% Money Back Guarantee. If for any reason you are not satisfied with a product or purchase, you can return the product within 30 days of receipt for a full refund, credit or exchange.

When you continually offer a quality product for a reasonable price, people come back! If you haven't already decided for yourself, then check out our Money Back Guarantee. Classic Industries® is continually the most competitively priced muscle car parts supplier year after year. We research each and every product we sell to make sure you getting the quality you want at the lowest price possible. Many of the products in this catalog are manufactured by Classic Industries®. We painstakingly scrutinize every product we offer for quality manufacturing materials and craftsmanship before it's offered in any of our catalogs. We know that not all restoration parts are created equal. We have years of experience in manufacturing the highest quality reproductions using the latest methods to ensure originality and detail. Many of the quality restoration products you purchase from Classic Industries® are officially licensed and approved by Chrysler. The restoration industry has changed dramatically over the last fifteen years and the restoration enthusiast is considered well informed and educated. This means

parts suppliers must recognize the need for not only quality parts and accessories, but the special attention to detail and crucial *after the sale* support most customers appreciate. Many restoration enthusiasts order parts, receive them, install them, and then wonder if the company you spent your money with will be there if you have a problem, or be in business tomorrow! If you know about restoration, then you know about Classic Industries®. The leader in restoration for two decades. After all, what else would you expect from the company that started it all!

- ✓ **Lowest Prices Guaranteed!**
- ✓ **The Finest Quality Reproductions!**
- ✓ **No Fault Product Protection Offer!**
- ✓ **100% Satisfaction or Your Money Back!**



Price Match Guarantee



If you find it for less we'll match the price!

Classic Industries® will match any competitors current advertised price for an identical product. Simply send us a copy of the competitor's current advertised price from a catalog, advertisement or website (with URL) and we'll match the price. The price match guarantee is available at the time the order is placed and for in-stock merchandise only. Price matching will be determined by a competitor's most current retail-published price and is limited to competitors within the Restoration Industry.

Important: In an effort to provide our retail customers with the most competitive pricing available, we will match our current competitor's pricing. Price matching will be determined by a competitor's most current retail-published price and is limited to competitors within the "Restoration Industry". Performance parts and special orders are exempt from price matching policy.

Classic Industries® reserves the right to decline price matching if pricing is deemed to be a special offer, a sale or closeout price, or a non-current price. Competitors sale pricing, inventory reductions, close outs, special promotional offers, etc. may be exempt from the "price match" guarantee. The guarantee is subject to the terms and conditions of Classic Industries® current policies.

Classic Industries® will generally contact competitors to confirm that the published price is current due to market changes, demand or availability. Price matching supersedes all other promotional offers and on sale pricing. If Classic Industries® matches a price from a competitor, additional discounts on that product or products may not apply. If the standard retail price of a product is higher than the competitor's price and an applied discount reduces the price below the competitor's pricing, the now discounted or sale pricing will prevail. We reserve the right to change or revoke this offer at any time without notice. Classic Industries® reserves the right to decline price matching.

Think Of Us As Your Partner In Restoration!

A restoration can take years! We understand the complications and problems that can occur when ordering precious parts for your project car. If you are like most people, you want perfection. The many different elements that make up a restoration isn't just limited to the parts you install. You sometimes need to rely on other outside elements such as body shops, painters, upholstery specialists and parts suppliers. That's where we come in. We offer the quality parts you want without all the guesswork. We carry one of the largest inventories of restoration products and accessories the market has to offer. What's more, you can rely on our nearly

40 years of experience to help you through the rough spots when you need it. Our tech advisors are always ready and willing to discuss any problem you may have concerning the parts for your vehicle and your restoration. Unlike other companies, we give you knowledgeable sales representatives, one of the largest inventories in the business, quick and efficient delivery, Toll Free ordering, and the experience to back it up. If you're not absolutely 100% satisfied with the products you receive. We'll refund 100% of your money! Classic Industries® - your partner in restoration!

Form of Payment

How to Order



CREDIT CARDS

Classic Industries® accepts Visa, MasterCard, American Express, Optima, and Discover for your convenience. When placing your order, be sure to indicate the card holders name, address, home phone, business phone, credit card number and expiration date and billing address (if different from person placing order). A security code is required for credit card purchases. Please have your credit card readily available when placing your order. Minimum order is \$20.00. New or 1st time customers who are paying by credit card must have the order shipped to the cardholders billing address for the first order. Invalid or non-matching billing addresses could delay your shipment.

CERTIFIED CHECKS

Classic Industries® will accept certified checks for your mail order. Be sure to include customer number and/or reference invoice number. Contact your bank to issue a certified check in the amount due for your order. All orders paid by certified check are held up to 15 days pending clearance.

PERSONAL CHECKS

To use personal checks or business checks on pre-paid orders, the name, address, and check number must be pre-printed on the check. Be sure to include customer number and/or reference invoice number. Only first party checks will be accepted. All orders paid by personal check are held up to 15 days pending clearance.

MONEY ORDERS/CASHIERS CHECKS

To use money orders or cashiers checks on pre-paid orders be sure to include customer number and/or reference invoice number. All orders paid by money order are held up to 15 days pending clearance. Once released the order will leave within 24 hours of clearance.

Make Personal Checks or Money Orders payable to:
Classic Industries®

PAYPAL

Classic Industries® now accepts payments via PayPal! Simply complete your order over the phone with a customer service representative, get your invoice number and then send your payment to paypal@classicindustries.com through PayPal's "Send Money" feature and select "Goods and Services" for payment reason. Be sure to include your invoice number in the "Special Instructions" tab at checkout for fastest service. Orders are generally shipped within 72 hours or less of payment receipt. Contact your customer service department for additional details.



MAIL ORDERS

Fill out the order form located in the back section of this catalog. For quick service use your credit card, money order, or cashiers check. Personal checks are held for 15 days from date of receipt pending clearance. All mail orders must be pre-paid including freight (when applicable). COD orders through the mail will not be accepted. If you have any questions regarding product information or availability, contact our sales representatives during regular business hours at 800.854.1280.



ORDER BY PHONE

Classic Industries® employs knowledgeable sales representatives to assist you when placing your order. Our sales representatives are trained to answer your questions regarding restoration and the parts listed in this catalog. Call during regular business hours Mon-Fri 8:00-5:00, Sat 10:00-3:00, P.S.T. Closed Sundays and holidays. Our convenient Toll Free number allows you to place your order with confidence to assure you get exactly what you want when you want it! Inter-continental US 800.854.1280. Outside U.S. country code + 1.714.847.6887



TOLL FREE 800-854-1280

FAX YOUR ORDER

Classic Industries® offers a convenient FAX line for customers who have access to a FAX machine. Our FAX is available 24 hours a day 7 days a week for your convenience. Fill out the order form completely and FAX your order. Within US 800.300.3081. Outside U.S. country code + 1.714.848.9501



TOLL FREE 800-300-3081

ON-LINE ORDERING

Classic Industries® offers on-line ordering directly through our website. Log on to classicindustries.com and order on-line. On-line ordering is available 24 hours a day 7 days a week for your convenience.



WWW.CLASSICINDUSTRIES.COM

FOREIGN ORDERS

All foreign orders must be pre-paid before the products can be shipped. The Classic Industries® staff will check with the various freight companies that deliver to your country and area to determine the best possible rates available for your order. Once your order is rated, you'll be contacted by e-mail or phone to approve the rate. After approval and payment is received, the order will be shipped. The Shipping & Handling held for foreign orders will state "TBD" (To Be Determined). Rates are subject to change once the order has been packed and is ready to ship. Rates are calculated based on estimations of weight, dimensions and other factors. Should changes in freight costs occur once the order is packed and ready to ship, Classic Industries will notify the customer immediately before the shipment is sent. If you have any questions or concerns, please direct your inquiries to info@classicindustries.com

Color Matches

Due to multiple manufacturers of products Classic Industries® provides, color variations may occur. Slight color variations are common especially among interior products and do not constitute a defect. These products are not eligible for return for this reason.

Pricing

Prices in this catalog were in effect at the time of printing and supersede all prices in any previous publication. Classic Industries® makes every effort to honor the pricing contained herein. However, due to increased costs of manufacturing, materials, etc., prices can change. We reserve the right to change prices without notice. For current pricing please contact a Classic Industries® sales representative during normal business hours. Eligibility of products for discounts are subject to change without notice.

Trademark and Copyright

Classic Industries® Parts and Accessories catalog is copyrighted. No part of this publication including text, photos or illustrations may be reproduced without the prior written permission of Classic Industries®. The following names and/or symbols: *Mopar, Dodge, Plymouth, Barracuda, Belvedere, Coronet, Challenger, Charger, Cuda, Dart, Duster, Fury, GTX, Hem, Pkara, Road Runner, Six Pack, Super Bee, Scamp, Valiant* are registered trademarks of Chrysler Group, LLC and are used for reference purposes only unless specified otherwise.

Product Availability

Availability of all items in this catalog are subject to change without notice. We reserve the right to discontinue products, services or accessories without notice.

Shortages

Always check the contents of your delivery to assure all the parts ordered were received. If you are missing any item(s) be sure to check for back orders noted on your invoice before calling our customer service department (see back orders). If a shortage has occurred, contact our customer service department within 2 working days of delivery to assure a prompt replacement. Classic Industries® assumes no liability after this period.

General Information

Sales Tax Information

Orders shipped outside of California may be exempt from sales tax. California residents are required to add the appropriate current sales tax. Due to regular variations in California sales tax, rates are subject to change without notice. California orders are subject to tax on handling fees, COD fees and rush fees. This additional tax will be applied to the invoice. As of the printing date of this catalog, the current rate is 8%.

Accuracy of Descriptions

Classic Industries® makes every effort to assure the accuracy of all information published in this catalog. Each item is represented with information that is accurate to the best of our knowledge at the time the catalog is printed. Classic Industries® is not responsible or liable for mistakes, print errors or inaccurate information that may lead to, or result in labor costs or damages to any vehicle under any circumstances.

Kit Products

All Classic Industries® Parts and Accessories catalogs include kits which contain a variety of products. On occasion we may run out of an item supplied with a kit. If this happens we will generally ship what is in stock and back order the item(s) which are not in stock. You may contact our sales department by phone to verify which items are not in stock at the time the order is placed. The customer may decide whether to accept the partial kit or have the entire kit back ordered until the kit is completed and all the items can be shipped at the same time. If the customer decides to accept partial delivery of the kit, then the full price of the kit will be charged to the customer and the back ordered items will be shipped no charge when they arrive at our warehouse. Customers will be charged the appropriate freight fees when applicable. Cancellation of products from a kit will be accepted at 25% below the actual current retail price of the item. On COD orders the price of the kit is charged in full and the back ordered items are shipped on a COD freight only basis.

Rights and Lefts

Some items in this catalog are presented as right or left hand products, (right side-passenger) (left side-driver). Right hand or left hand sides are determined by sitting in the vehicle, not standing in front of the vehicle.

Shipping Information

ALASKA, HAWAII, GUAM & PUERTO RICO

Orders being shipped to Alaska, Hawaii, Guam or Puerto Rico, are shipped via Ground, Overnight or 2 Day Delivery whenever possible. All orders must be pre-paid with credit card, money order, or check. No COD orders are accepted. Rates depend on the items being shipped. Contact our sales department for exact rates.

Important: Promotional shipping offers do not apply to Alaska, Hawaii, Guam, Puerto Rico, Canada or any foreign destination.



APO/FPO

Parcel post is the only means of shipping to an APO or FPO address. Due to size restrictions the maximum shipping box can be no larger than 72" width and girth combined. All military personnel must write or call to determine what size box will be used for the shipment. Once this is determined, Classic Industries® will call or write to let you know if the order can be shipped by Parcel Post, and the correct amount required. All orders that exceed these limitations will be shipped in accordance with customer approval.

INSURANCE

Each order is charged an insurance fee of \$3.50. This fee will insure the entire order and protect you completely from damages or loss. The order forms located in the rear of this catalog include this fee in the indicated column when your order is being totaled.

COD ORDERS

COD orders are gladly accepted on all normal ground shipments, excluding truck freight orders. COD orders will require cash only upon delivery of your order. All COD orders are shipped by Fed Ex. Personal checks, business checks, money orders and certified checks are not accepted. COD orders are not accepted through the mail. COD orders must be placed by phone during regular business hours. The appropriate shipping fees will be added. COD orders are exempt from discounts and free shipping promotion. The customer will pay all appropriate fees in accordance with current policies and freight rates. A fee of \$11.95 per box will be added to all COD orders. Overseas and/or overnight boxes will be charged in accordance with the rate chart located on the order blank. Classic Industries® reserves the right to change shipping rates in accordance with rate increases by freight companies. COD orders are limited to \$999.00. If the COD order should be returned to Classic Industries® for non acceptance/non payment, the customer will be responsible to reimburse Classic Industries® for any and all freight charges related to the order. In addition, a 25% restocking fee will be applied to the returned products. All outstanding charges must be paid before any additional orders will be accepted.

SPECIAL RATE SHIPPING FEES/DROP SHIP FEES

Some items we offer may require a mandatory shipping or drop ship fee. This fee may also apply to products sold over the counter at Classic Industries® Showroom location. Contact our sales department for actual additional shipping fees.



Important: Products with special rate shipping fees or drop ship fees are excluded from promotional shipping offers.

General Information

Back Orders

The invoice located in the packing slip of your order will notify any items that were out of stock at the time of shipping. The unavailable items will be back ordered unless otherwise specified on your order form or verbally to a sales representative when placing your order by phone. Back orders are usually shipped when the products arrive at our warehouse without prior notification. Classic Industries will make an effort to contact the customer if the backorder is more than 90 days old. If you wish to cancel a back order, please notify our customer service department immediately. The customer will be responsible for a 25% restocking fee and freight charges if the back order is cancelled or returned after the items are shipped.

Damage Claims

Always check the contents of your shipment in the presence of the person delivering the merchandise. Should any damage occur, immediately notify Classic Industries® customer service dept. so that all steps necessary will be taken to ensure a prompt replacement of any damaged goods. Accurate instructions will be given on damaged goods replacement. Classic Industries® is not responsible if no notification is given within 2 working days of receipt of goods (excluding Sundays and Holidays). Classic Industries® will file a claim with the carrier in most cases. If the customer files a claim with the carrier, Classic Industries® will not be responsible for replacing damaged products and the customer will be responsible to pay for any replacements until the carrier pays no claim. Any replacement parts due to sales errors or customer errors in ordering will be sent using the same shipping method as the original order when possible. Please follow these instructions to avoid any problems or misunderstandings associated with damaged products and freight claims.

Refunds

All refused COD orders will be subject to a 25% restocking fee. Classic Industries® will consider the entire order cancelled and void with no notification to the customer. The customer will be billed 25% plus all freight charges to and from the destination. Contact our customer service department for more information.

Policies

All policies in Classic Industries® current catalog supersede any and all policies in any previous catalog or publication.

EXPRESS SHIPPING

Classic Industries® offers Overnight and 2 Day air delivery service in the Continental U.S., Alaska, Hawaii, Guam and Puerto Rico. Pre-payment with a credit card is required before shipments can be sent. Simply call in your order before 2:00 p.m. Pacific Time, Monday-Friday during regular business hours and your Overnight order will arrive the following business day (pending availability). Saturday delivery is available only on Overnight service. A \$16.95 fee will be added to Overnight fees for Saturday delivery. 2 Day orders will arrive within 2 business days (pending availability). 3 Day service is available within the contiguous 48 states. Your order will usually leave within 24 hours and will arrive within 3 business days of ship date (pending availability). A \$9.95 service fee for any of these options will be added in addition to shipping fees. Contact our sales department for rates regarding air service delivery. Rates depend on the items being shipped. Some products are charged at dimensional weight as opposed to actual weight.

Important: Air service does not guarantee your order will arrive on the expected date of delivery. Under normal circumstances, air service is guaranteed. However, due to adverse weather conditions, natural disasters or unforeseen circumstances, there may be delays. Classic Industries® is not responsible for deliveries that are delayed. Air service orders are excluded from promotional shipping offers.

TRUCK FREIGHT

Products in this catalog that require truck freight are usually indicated below the product "Shipped truck freight". This indicates that the product is too large for ground delivery and must be shipped by motor freight. There may be items listed herein that are not indicated as truck freight. These items must be pre-paid, including freight charges, before the shipment can be sent. Classic Industries® requires a minimum \$125.00 fee for all California orders and minimum \$175.00 fee for all out of state truck shipments. Truck freight rates could be higher depending on products being ordered and the destination. Residential deliveries require an additional \$40.00 fee. Should the customer's delivery require special handling (lift gate service, re-routing, additional freight charges, etc.), any and all additional fees will be billed to the customer's credit card. Acceptance of truck freight shipment is acknowledgment that additional charges will be incurred. Please include a commercial business address whenever possible. For additional information contact our customer service department during regular business hours. **Important:** Truck freight items are excluded from promotional shipping offers.



OVERSIZE-OVERWEIGHT

These are the designations for Ground or Standard packages that meet one of the following specifications for billing purposes: Oversize 1 (OS1) designates a combined length and girth exceeding 94", but less than 108". Actual weight is less than 30 lbs, and is billed at 30 lbs. Oversize 2 (OS2) designates a combined length and girth exceeding 108" but less than 130". Actual weight is less than 70 lbs, and is billed at 70 lbs. Oversize 3 (OS3) designates a combined length and girth exceeding 130" but less than 165". A \$40.00 handling fee will be added to all (OS3) orders. Actual weight is less than 90 lbs, and is billed at 90 lbs. We reserve the right to charge Oversize fees on any order containing overweight products, even if it is not indicated in the catalog. **Important:** Oversize, overweight and dimensional weight items are excluded from promotional shipping offers.



Sales Errors/Ordering Errors

Classic Industries is not responsible for customer errors or employee sales errors. Every effort is made to insure that the products you are ordering are accurate. Should an error occur, we will make every effort to resolve the issue. Replacement products will be shipped the same method as the original order whenever possible. Classic Industries assumes no responsibility or liability for damages, fees, storage charges, or any other inconvenience that may be associated with sales errors or customer ordering errors.

Returns

Products may be returned for a full refund on the product, credit or exchange within 30 days of receipt. All returns are subject to a 25% restocking fee after 30 days. Should you need to return a part for refund, exchange or credit, please contact our customer service department for a return authorization number and instructions. Classic Industries® will not accept returned goods without prior authorization. Customer will pay freight on all return orders. Allow up to 3 weeks to process refund or credit.

Important: Gift certificates have no cash value and must be redeemed for merchandise only. Literature, CDs, videos, printed materials, stencil kits, straps, electrical parts, gears, wiring harnesses, switches, etc. are non-returnable. All special order products must be pre-paid in full and are non-returnable. No returns on partial kits or sets. There is no guarantee on moving parts such as engines, transmissions, rear ends, steering axles, water pumps, distributors, wiper motors, etc. If any product is modified, altered, painted, installed or disassembled in any way without Classic Industries® expressed written permission, the item is non-returnable. Classic Industries® always recommends professional installation on all products. Any item which has been altered, painted, installed or deemed non-returnable by Classic Industries® will be returned to the customer at the customer's expense. Classic Industries® is not responsible or liable for labor fees associated with the installation, removal, modification, painting or repair of any product purchased regardless of the circumstances. Classic Industries® is not responsible for any damage or discoloration incurred in relation to chemical products being used including cleaners, waxes, polishes, paints, etc.

How to FILL OUT YOUR ORDER FORM

Billing Information:

If paying by credit card, fill in the card holder's name and billing address (where the credit card statements are received).

Shipping Information:

If different than the billing address, please fill in the name and address where the order will be sent.

Page Number:

The page # of the product being ordered.

Quantity:

How many of each item you are ordering.

RH/LH:

RH (pass. side) or LH (drivers side) if applicable.

Oversize/Overweight:

Enter correct amount if applicable.

Part Number:

Enter part number as it appears in this catalog.

Product Description:

The name of the product as it is listed in this catalog.

Method of Payment:

Check the appropriate box for payment. If you are paying by credit card, fill in the card number, expiration date, security code, and card holder's signature.

Shipping Chart:

Information on the amount of shipping & handling fees you will be charged.

Vehicle Information:

Complete information about your vehicle.

Customer Number:

Usually located on the back of your catalog, above your name.

Catalog Number:

Located on the front upper right corner of the catalog cover.

E-mail Address:

Enter your E-mail address.

Date of Order:

Enter the date of your order.

Number of Pages:

Enter the number of pages you are sending.

Discount/Promotional Code:

Enter the discount or promotional code.

Unit Price:

The unit price of each item.

Total Price:

The individual price of each product multiplied by the quantity being ordered.

Subtotal:

The total amount of products ordered.

California Sales Tax:

Orders shipped within California add 8%.

Shipping/Handling Fee:

Enter appropriate amount using the shipping chart.

Canadian Orders:

Add 25% of your subtotal or a minimum of \$10.00 U.S. funds, whichever is higher.

Oversize/Overweight and Double Oversize:

Check the quantity of items and add the appropriate amount based on the chart.

Foreign Orders/Rush Fees:
Contact Classic Industries® for current shipping rates to your country.

APD/FPD:

Add 20% of your subtotal or a minimum of \$10.00 U.S. funds, whichever is higher.

Total:

Total of all items including tax and shipping.

Classic

INDUSTRIES®

Parts & Accessories

Thank You For Choosing Classic Industries®

- If you have questions, please call and a sales representative will help you with completing the order form.
- Classic Industries® will notify you if any price changes need to be made to your order form.
- Classic Industries® will notify you if any products are on back order.
- Go to www.classicindustries.com to use our convenient on-line order form

How to READ

Your Invoice

Invoice Number

Each order is assigned an individual invoice number.

Account Number

Your customer number.

Billing Information

Customer mailing address or where the credit card statements are received.

Vehicle Information

Shows your vehicle's year, model, etc.

Quantity Ordered

The number of each part that you've ordered.

Unit of Measure

Indicates if an item is sold individually, as a pair, kit or set.

Part Number

Part number as it's listed in the catalog.

Sale Item

"S" indicates sale item not eligible for discounts.

Product Description

Description of the part ordered.

Quantity Shipped

Number of items shipped.

Quantity Back Ordered

Number of items out of stock.

Payment Information

This shows the type of payment (cash, credit card, etc.) and the amount billed.

Printed By: [Redacted]
 Prepared By: [Redacted]
 Shipped By: [Redacted]
 Date Recd: [Redacted]

Source: 1 to 2 China & 200 Accessories Parts and Accessories

Within U.S.: 800-854-1280
 International: 1-714-847-6887
 Email: info@stevesautohobbies.com
 On-Line Ordering: www.stevesautohobbies.com

3885 Solano Street Huntington Beach, CA 92648
 Page: 1 of 1

Order Date of Order: MODIFIED: 03/02/2004
 ORIGINAL: 03/02/2004

Subscriptions Count: 0000
 800000RNL1234567-7.95

Billing Address		Shipping Address	
Name:	FAKES, LARRY	Name:	FAKES, LARRY
Address:	18460 GOTHARD ST.	Address:	18460 GOTHARD ST.
City:	HUNTINGTON BEACH	City:	HUNTINGTON BEACH
State:	CA	State:	CA
Country:	UNITED STATES	Country:	UNITED STATES
Zip/Postal:	92648	Zip/Postal:	92648
Attention:		Attention:	
Phone:	(714) 847-6887	Phone:	(714) 847-6887

Year	Model	Body Style	Color	Interior Style	Qty	Unit	Total Price
1967	STANDARD	COUPE	TRANSISTOR		1	0	8.96
	ENGINE SIZE:	CYLINDERS:	EST COLOR:				2.50
	LINE ITEM SUBTOTAL:						12.46
	20.00% VOLUME DISCOUNT:						3.49
	DISCOUNT SUBTOTAL:						18.96
	***CREDIT #00000 APPLIED TO INVOICE						8.00

Product: Temporarily Out of Stock - Please allow 4-6 weeks from the date of your order.

THANK YOU.
 *****1234 06/01/2005 118.41

Shipping and Handling: 7.95
 COD Fee: 0.00
 Mark / International Fee: 0.00
 California Sales Tax: 0.00
 Package Insurance: 1.50
 Product Protection Plan: 0.00
Invoice Total: 18.41

Date of Order

This is the date your order was originally placed.

Sales Person

The person that took your order.

Shipping Information

The address your order was shipped to.

Unit Price

The cost of each individual part.

Total Price

The total price of each part multiplied by the quantity ordered.

Sub Total Price

The total of all parts.

Discounts

The total of discounts applied.

Sub Total Price

The total of all parts and discounts applied if applicable.

Credits

The total of credits applied.

Sub Total Price:

The total of all parts, discounts and credits if applicable.

Misc. Fees:

This includes shipping and handling, rush charges, insurance and sales tax if applicable.

Invoice Total:

The total of all parts shipped and fees for your complete order.

If you have any question regarding your invoice
 please contact us at 800-854-1280 during regular business hours and
 customer service representative will gladly assist you.

THE ALL NEW www.classicindustries.com



Improved Account Management!

Managing your account couldn't be simpler! Update your information, track your orders, build up and modify your wish list, and more, all at your convenience.



All New Shopping Experience!

Our redesigned web site is much more than just a sleek new look. Improved usability and a streamlined checkout process eliminate the hassle of ordering parts for your project!



More Product Detail!

Multiple product views give you the full picture of what you're ordering. "Also Fits" information and the "Ask a Tech" feature ensure that you get the right part for your project!



Improved Product Search!

New search capabilities make it easier than ever to browse our product line! "Shop by Brand" lets you check out the latest from the names you know and the brands you trust!



Social Media Integration!

Social media updates, news, videos and articles are easily accessible right from the main page! See posts from our upcoming Classic Industries® blog site blog.classicindustries.com/



At A Glance!

Scroll through the most popular items Classic Industries® has to offer using our new *Most Popular*, *Top Sellers* and *Most Viewed* tabs!



SOCIAL
MEDIA



Your All-Access Pass to Classic Industries®

Receive special sales codes, promotions and product updates on our Facebook, Google + and Twitter pages!



Follow us on Facebook, Google + and Twitter!
Receive special sales codes, promotions and product updates.
Stay informed on special events and interact with other automotive enthusiasts, staff and fans of Classic Industries®!

www.facebook.com/classicind

Cruise on over to Classic Industries' new video media website where you can access a library of *Overhaulin'*, *Chop Cut Rebuild*, and *My Classic Car* episodes, Classic Industries® television commercials and how-to videos to guide you through installation processes.

www.classicindustries.tv



Watch up-to-date instructional videos, television commercials and interact with our community of automotive enthusiasts!

Mopar Order Form

Classic Industries®

18460 Gothard St., Huntington Beach, CA 92648

- New Customer
 Change of Address
 Please Check appropriate box (if applicable)

Order Toll Free 800.854.1280
24 Hour FAX 800.300.3081
International Phone 714.847.6887
International FAX 714.848.9501



Customer Number

See the address label on the back of the catalog

Catalog Number

See top right of front cover of the catalog

E-mail Address

Get the latest information on new parts & special sales!

Date Of Order

____/____/____

PAGE ____ of ____ PAGES

Attach second order form when the number of items you are ordering exceeds the spaces on one order form.

Discount/Promo Code

Enter the discount or promotional code above. The discount will be automatically calculated based on the correct discount amount if available when your order is processed.

See Ordering and Shipping Policies for additional information.

Vehicle Information

Year of vehicle [][] [][]	Model <input type="checkbox"/> 330 <input type="checkbox"/> 440 <input type="checkbox"/> Barracuda <input type="checkbox"/> Belvedere <input type="checkbox"/> Challenger <input type="checkbox"/> Charger <input type="checkbox"/> Comet <input type="checkbox"/> Cuda <input type="checkbox"/> Dart <input type="checkbox"/> Dart Sport <input type="checkbox"/> Daytona <input type="checkbox"/> Demon <input type="checkbox"/> Duster <input type="checkbox"/> Fury <input type="checkbox"/> GTX <input type="checkbox"/> Lancer <input type="checkbox"/> Polara <input type="checkbox"/> Road Runner <input type="checkbox"/> Satellite <input type="checkbox"/> Savoy <input type="checkbox"/> Scamp <input type="checkbox"/> Sport Fury <input type="checkbox"/> Super Bee <input type="checkbox"/> Superbird <input type="checkbox"/> Valiant
Body Style <input type="checkbox"/> Sedan 2-door <input type="checkbox"/> Sedan 4-door <input type="checkbox"/> Wagon 2-door <input type="checkbox"/> Wagon 4-door <input type="checkbox"/> Coupe 2-door hardtop <input type="checkbox"/> Sedan 4-door hardtop <input type="checkbox"/> Convertible <input type="checkbox"/> Fastback 2-door <input type="checkbox"/> Other _____	Interior Material <input type="checkbox"/> Cloth <input type="checkbox"/> Vinyl <input type="checkbox"/> Leather <input type="checkbox"/> Other _____
Interior Type & Color Please Specify Engine Size & Trans V-8 <input type="checkbox"/> 313 <input type="checkbox"/> A-727 (AT) <input type="checkbox"/> 318 <input type="checkbox"/> A-904 (AT) <input type="checkbox"/> 340 <input type="checkbox"/> 4-Spd MT <input type="checkbox"/> 360 <input type="checkbox"/> 3-Spd MT <input type="checkbox"/> 361 <input type="checkbox"/> Powerline <input type="checkbox"/> 383 <input type="checkbox"/> A-500/518 <input type="checkbox"/> 400 <input type="checkbox"/> 413 <input type="checkbox"/> 426 Wedge <input type="checkbox"/> 426 Hemi <input type="checkbox"/> 440	Seats <input type="checkbox"/> Front buckets <input type="checkbox"/> Front bench <input type="checkbox"/> coupe w/buckets <input type="checkbox"/> coupe w/buckets wagon w/2 seats wagon w/3 seats <input type="checkbox"/> Other _____
Slant-6 <input type="checkbox"/> 170 <input type="checkbox"/> 198 <input type="checkbox"/> 225	Console <input type="checkbox"/> yes <input type="checkbox"/> no Factory Air <input type="checkbox"/> yes <input type="checkbox"/> no

Please check box if you require additional order forms.

Billing Address

Important: If your shipping address is different from your billing address, fill in shipping form below.

Name _____

Address _____

City _____ State _____

Zip _____ Daytime Phone (____) _____

When using a credit card please fill in card holders name, address and phone number.

Shipping Address

Important: Please include a physical street address for delivery. Orders will not deliver to a P.O. box.

Name _____

Address _____

City _____ State _____

Zip _____ Daytime Phone (____) _____

If different from billing phone number.

Page Number	Quantity	RH LH	Passenger Drivers	Oversize Overweight	Part Number	Product Description	Unit Price	Total Price

Method of Payment

- Cashiers Check
 Personal Check
Please charge my: ✓
 Money Order
 Certified Check
 VISA
 MasterCard
 DISCOVER
 PAYPAL

Credit Card

Credit Card Number

Expiration Date _____ Security Code _____
 Month Year Required

The security code is a 3 or 4 digit number located on the front or back of your credit card.

Cardholder Signature

Subtotal

California Residents Add 8% sales tax
 Shipping Fee
 Handling Fee
 minimum \$10.00 U.S. funds

TO BE DETERMINED*

\$3 .50

Canadian Orders add 25% minimum \$10.00 U.S. funds

Oversize/Overweight and appropriate amount

Foreign Orders/Rush Fee include appropriate amount

APQ/FPQ 20% minimum \$10.00

Total

Note: *Shipping fees are determined when order is entered.



Please put the completed order form out and FAX it or mail it to the indicated address.

ORDER FORMS & INDEX

Product Index

A

A-Pillar Molding.....	89
A-Pillar, Windshield.....	283
AC Belt.....	386
AC Clutch Cycling Switch.....	389
AC Compressor.....	386-388
AC Compressor Bracket.....	387
AC Condenser.....	388
AC Data Tag.....	388
AC Evaporator Core.....	388
AC Expansion Valve.....	389
AC Heater Control Switch.....	389
AC Heater Control/Vacuum Hose Set.....	389
AC Hose Bubble Cramper Tool.....	389
AC Low Pressure Switch.....	389
AC O-Ring Set.....	389
AC Receiver/Drier.....	389
AC Retrofit System.....	385
AC Vacuum Canister.....	389
Accelerator Pedal Assembly.....	143
Accelerator Pedal Pad.....	144
Accelerator Pedal Pad Bezel.....	144
Accelerator Pedal Roller.....	144
Accelerator Pedal Seal.....	144
Accelerator Pump Squitter, Carburetor.....	467
Accessory Modules.....	523, 525
Accessory Terminal.....	509
Accessory Wire.....	511
Actuator Cylinder, Convertible Top.....	301
Actuator Lever, Parking Brake.....	363
Actuator, Fresh Air Vacuum.....	277
Actuator, Headlamp Door.....	249
Adapter Plug Set, H4 With Wires.....	250
Adapter, Battery Side Terminal.....	508
Adapter, Tachometer.....	434, 437
Adapter, Throttle Lever.....	464
Adapter, Tilt Column Steering Wheel.....	134
Adapters & Filter, Transmission.....	487
Adapters, Seat Mounting.....	53
Adhesive, Emblem & Trim.....	207
Adhesive, Glass.....	467
Adhesive, Weatherstrip.....	230
Adjustable Fan Temperature Sensor.....	382
Adjuster Set, Headlamp.....	249
Adjusting Sleeve, Tie Rod.....	328, 330
Aerosol Can Trigger.....	197
Air Box Seals.....	234
Air Cleaner.....	421-427
Air Cleaner Base Gasket.....	421
Air Cleaner Baseplate.....	420, 427
Air Cleaner Breather Hose.....	419
Air Cleaner Lid.....	277, 420, 426
Air Cleaner Lid Decal.....	210
Air Cleaner Pie Tin.....	421
Air Cleaner Service Instruction Decal.....	210
Air Cleaner Spacer.....	421
Air Cleaner Stud.....	421
Air Cleaner Wing Nut.....	421, 465
Air Conditioner / Heater Wiring Harness.....	520
Air Conditioning Decal.....	213
Air Dam, Front.....	266
Air Filter Element.....	420-427
Air Filter Oil & Clean/Degreaser Kit.....	423
Air Filter Oiling System.....	425
Air Grabber Assembly.....	276-277
Air Grabber Decal.....	208, 210
Air Grabber Door Decal.....	208
Air Grabber Door Hinge.....	277
Air Grabber Door Clips.....	276
Air Grabber Insert.....	276
Air Grabber Switch Bezel.....	276
Air Intakes.....	424-425
Air Pump Belt.....	469
Air Shroud Plate.....	421
Air Suspension System.....	335
Airbrush Painting Manual.....	176
Alarm System.....	181
Alternator.....	447-448
Alternator Bracket.....	448
Alternator Inspection Decal.....	211
Alternator Positive Wire Insulator.....	448
Alternator Wiring Clip.....	448
Aluminum Radiator.....	378
Ammeter Gauge.....	106-107

Amperage Gauge.....	105
Antenna.....	127
Antenna Bezel.....	127
Antenna Lock Nut.....	127
Antenna Lock Nut Tool.....	127
Anti-Squeak Felt, Fuel Tank.....	411
Antifreeze Decal.....	251
Apparel Patch.....	149
Applicator Pad.....	188
Applicator, Decal.....	224
Arm Rest Base.....	84
Arm Rest Hinge Washer.....	55
Arm Rest Pad.....	85
Arm Rest Screw.....	85
Arm Wiper.....	320
Art Prints.....	160-161
Ash Tray Bumper.....	232-233
Ash Tray Door, Console.....	140, 142
Ash Tray, Console.....	140, 142
Ash Tray, Rear.....	83
Assembly Lube.....	433
Automatic Transmission Dipstick.....	490
Automatic Transmission Pan.....	490
Automotive Literature.....	168-179
Aux-In Axle Adapter.....	125
Axle & Differential Manual.....	177
Axle Bearing.....	341
Axle Bearing Retainer Gasket.....	341
Axle Shaft.....	341

B

Back Glass Lower Filler.....	290
Back Glass Reveal Molding.....	244
Back Glass Reveal Molding Clip.....	244
Back Window Glass.....	246
Back-Up Lamp Assembly.....	258
Back-Up Lamp Housing.....	259
Back-Up Lamp Lens.....	258, 259
Back-Up Lamp Socket Cover.....	258
Back-Up Lamp Wiring Harness.....	519-520
Back-Up Lens Gasket.....	259
Badge Holder.....	149
Balancer, Harmonic.....	406
Ball Joint Dust Boot.....	329
Ball Joint Removal Tool.....	330
Ball Joint, Control Arm.....	329
Ballast Resistor.....	445
Ballast Resistor Bracket.....	429
Ballast Resistor Wire.....	440
Ballast Resistor Wiring Pigtail.....	445
Bar, Door Aligning.....	286
Bar Stabilizer.....	333
Barrel Nuts, Emblem.....	206
Base, Arm Rest.....	84
Baseplate to Hood Seal.....	421
Baseplate, Air Cleaner.....	420, 427
Battery.....	504
Battery Cable.....	506-507
Battery Cable Bolt.....	508
Battery Cable Strap.....	507
Battery Cable Tags.....	507
Battery Cable Terminal.....	508
Battery Cable Terminal Protector.....	507-508
Battery Cutoff Switch.....	508
Battery Decal.....	212
Battery Disconnect, Remote Control.....	180-181
Battery Load Tester.....	509
Battery Maintenance Devices.....	510
Battery Mat.....	509
Battery Side Terminal Adapter.....	508
Battery Tools.....	508-510
Battery Tray.....	504-505
Battery Tray Brace.....	504
Battery Warning Decal.....	213
Bearing & Seal Kit, Wheel.....	361
Bearing, Axle.....	341
Bearing, Differential.....	341
Bearing, Lower Shift Tube.....	135
Bearing, Lower Steering Column.....	135
Bell Crank, Clutch.....	800
Belt Buckle.....	159
Belt, AC.....	386
Belt, Paint.....	159
Belt, Power Steering.....	327

Belt, Smog Pump.....	469
Belt, Water Pump.....	384
Bench Seat Upholstery.....	34-51
Bezel, Gasket, Tail Lamp.....	235
Bezel, Accelerator Pedal Pad.....	144
Bezel, Air Grabber Switch.....	276
Bezel, Antenna.....	127
Bezel, Brake Pedal Pad.....	84
Bezel, Convertible Rear View Mirror.....	105
Bezel, Dash.....	100-103
Bezel, Dome Lamp.....	88
Bezel, Headlamp.....	263
Bezel, Headlamp Switch.....	130
Bezel, Headrest.....	127
Bezel, Heater Control.....	159
Bezel, Hood Scoop.....	273
Bezel, Instrument.....	100-103
Bezel, Park Lamp.....	253
Bezel, Pistol Grip Shifter.....	502
Bezel, Rallye Dash.....	100-102
Bezel, Remote Mirror.....	287
Bezel, Road Lamp.....	249
Bezel, Road Lamp Switch.....	249
Bezel, Seat Back Release.....	57
Bezel, Shifter Boot.....	503
Bezel, Side Marker Lamp.....	255
Bezel, Side Scoop Trim.....	243
Bezel, Tail Lamp.....	257
Bezel, Trunk.....	204
Bezel, Trunk Lid Emblem.....	206
Bezel, Wiper Switch.....	131
Blade, Windshield Wiper.....	320
Blaircutter.....	323
Blower Motor Vent Tube.....	391
Board, Spare Tire Well.....	313
Board, Trunk Divider.....	27
Board, Trunk Side Panel.....	313
Body Markers and Paint.....	182
Body Plug.....	301
Body, Steel Skeleton.....	282
Bodywork Manual.....	179
Bolt Set, Differential.....	342
Bolt Set, Engine.....	409
Bolt Set, Flexplate.....	487
Bolt Set, Oil Pan.....	430-431
Bolt Set, Water Pump Mounting.....	384
Bolt, Battery Cable.....	508
Bolt, Brake Line Hose.....	359
Bolt, Head Spacer.....	448
Bolt, Thermostat Housing.....	383
Bolts, Bumper.....	262
Bolts/Straps, U-Joint.....	343
Booklet, Plymouth Service Policy.....	215
Boom Tube, Exhaust Side Pipe.....	483
Boost Gauge.....	352
Booster, Power Brake.....	117
Boat Storage Bag, Convertible Top.....	300
Boot Well Molding, Convertible.....	300
Boot, Ball Joint Dust.....	329
Boot, Convertible Top.....	299
Boot, Firewall Clutch.....	501
Boot, Hemi Spark Plug.....	443
Boot, Idle Solenoid.....	457
Boot, Shifter.....	496, 503
Boot, Tie Rod Dust.....	329
Box, Torsion Bar.....	329
Bottle, Radiator Overflow.....	379
Bow, Headliner.....	87
Bow, Rear Roof.....	290
Box, Torque.....	318
Brace, Battery Tray.....	504
Brace, Crankshaft.....	279
Brace, Fender to Cowl.....	280
Brace, Floor Support.....	302
Brace, Radiator Support.....	311
Brace, Rear Floor Pan.....	267
Brace, Trunk Floor To Valance.....	307
Bracket Strips, Radiator Fan Mounting.....	382
Bracket, AC Compressor.....	387
Bracket, Alternator.....	448
Bracket, Ballast Resistor.....	445
Bracket, Brake Line.....	359
Bracket, Bumper.....	261
Bracket, Bumper Guard.....	262
Bracket, Clutch Bell Crank Frame.....	501

Product Index

Bracket, Console Mounting.....	140, 142
Bracket, Console Rear Trim.....	142
Bracket, Convertible Rear View Mirror.....	94
Bracket, Distributor Hold Down.....	440
Bracket, Electric Radiator Fan.....	480
Bracket, Exhaust Tip Hanger.....	485
Bracket, Fender To Cowl.....	280
Bracket, Fresh Air Vacuum Actuator.....	278
Bracket, Front Disc Brake Hose.....	377
Bracket, Gearshift Control Torque.....	494
Bracket, Heater Hose.....	391
Bracket, Hood Pin.....	270
Bracket, Ignition Coil Mounting.....	439
Bracket, License Plate.....	305
Bracket, Muffler to Floor Pan.....	485
Bracket, Power Steering.....	325
Bracket, Radiator Overflow Mounting.....	379
Bracket, Rear Axle Hole.....	358
Bracket, Rear Seat Belt.....	305
Bracket, Rear Spoiler.....	309
Bracket, Rear Valance Panel.....	315
Bracket, Road Lamp Mounting.....	249
Bracket, Six Pack Idle Solenoid.....	465
Bracket, Spare Tire Hold Down.....	311
Bracket, Speedometer & Brake Cable.....	104
Bracket, Steering Column.....	135
Bracket, Tail Lamp.....	314
Bracket, Tail Lamp Reinforcement.....	314
Bracket, Throttle Cable Mounting.....	457
Bracket, Throttle Return Spring.....	465
Bracket, Tilt Steering Column.....	134
Bracket, Torque Shaft.....	501
Bracket, Transmission Cooler.....	490
Bracket, Transmission Cooler Line.....	490
Brackets, Front Sway Bar.....	332
Brackets, Headlamp.....	278
Brackets, Suspension Tie-Down.....	319
Brake & Clutch Hinge Bushing.....	142
Brake Actuator Lever, Parking.....	363
Brake Bleeder Screw & Brake Cap.....	363
Brake Booster Decal.....	214
Brake Booster to Firewall Gasket.....	353
Brake Booster, Power.....	352
Brake Cable Bracket.....	104
Brake Caliper, Disc.....	360
Brake Caliper/Drum Pan.....	354
Brake Combination Valve.....	354
Brake Distribution Block.....	354
Brake Drum.....	363
Brake Fluid.....	355
Brake Hose.....	346, 359
Brake Lamp Bulb.....	250
Brake Lamp Housing.....	104
Brake Lamp Switch.....	142
Brake Line Bracket.....	359
Brake Line Clips.....	359
Brake Line Fitting.....	359
Brake Line Hose Bolt.....	359
Brake Line Splash Shield.....	359
Brake Line T-Block, Rear Axle.....	354
Brake Line Wrench.....	355
Brake Lines.....	356-358
Brake Master Cylinder.....	347, 351-353
Brake Pad Spreader Tool.....	355, 361
Brake Pads, Disc.....	347, 360
Brake Pedal Pad.....	144
Brake Pedal Pad Bezel.....	144
Brake Pressure Gauge Tool.....	355
Brake Proportioning Valve.....	354
Brake Release Handle.....	128
BrakeRotor.....	360
Brake Shoes, Drum.....	360
Brake System Bleeder Tool.....	355, 359
Brake Tube Bending Tool.....	355
Brake/Fuel Line Shield.....	358
Brake/Parts Cleaner.....	355
Breather Cap.....	411
Breather, Valve Cover.....	416-417
Brochures, Sales.....	169
Brushes, Detailing.....	188-189, 366
Bucket Seat.....	52-53
Bucket Seat Back Panel.....	58-63
Bucket Seat Floor Reinforcements.....	55
Bucket Seat Truck Assembly.....	55
Bucket Seat Upholstery.....	18-33

Bulb, Brake Lamp.....	250
Bulb, Courtesy Lamp.....	250
Bulb, Glove Box Lamp.....	133, 250
Bulb, Heater Lamp.....	248, 250
Bulb, Instrument Panel.....	250
Bulb, LED.....	121
Bulb, License Plate Lamp.....	250
Bulb, Parking Lamp/Turn Signal.....	250
Bulb, Reading Lamp.....	250
Bulb, Seat Belt Warning.....	250
Bulb, Side Marker Lamp.....	250
Bulb, Tail Lamp.....	249-250
Bulb, Underhood Lamp.....	170
Bulb, Underhood Lamp Service.....	170
Bump Stop, Control Arm.....	332
Bumper Bolts.....	262
Bumper Bracket.....	261
Bumper Filler Panel.....	262
Bumper Guard.....	261
Bumper Guard Bracket.....	262
Bumper Guard Cushion.....	262
Bumper Sets, Rubber.....	233
Bumper, Clutch Pedal Stop.....	501
Bumper, Door.....	232-233
Bumper, Front.....	260-261
Bumper, Fuel Door.....	232-233
Bumper, Glove Box Door.....	232-233
Bumper, Hood Adjust Bumper.....	232-233
Bumper, Hood Stop.....	232-233
Bumper, Rear.....	232-233
Bumper, Rear.....	232-233
Bumper, Rear Axle.....	360
Bumper, Rear Axle.....	243
Bumper, Trunk.....	232-233
Bushing Kit, Strut Rod.....	334
Bushing, Shock.....	332
Bushing Set, Polyurethane.....	334
Bushing, Brake & Clutch Hinge.....	142
Bushing, Intermediate Shaft.....	441
Bushing, Lower Control Arm.....	329
Bushing, Upper Spring Shackles.....	339
Bushing, Torque Shaft.....	494
Bushing, Upper Control Arm.....	329
Button, Automatic Shifter Knob.....	494
Button, Outer Door Handle Push.....	288
Bypass Valve, Heater.....	389

C

Cable & Handle, Fresh Air.....	276
Cable Bolt, Battery.....	508
Cable Terminal Protector, Battery.....	508
Cable Terminal, Battery.....	508
Cable Tie, Stainless Steel.....	471
Cable Ties, Flexible.....	521
Cable Tool, Battery.....	508
Cable, Battery.....	506-507
Cable, Dash Reset Knob.....	103
Cable, Dash Vent.....	128
Cable, Engine To Firewall Ground.....	507
Cable, Heater/Defrost.....	128
Cable, Hemi Battery.....	507
Cable, Hood Release.....	128
Cable, Kickdown.....	492-493
Cable, Parking Brake.....	146-147, 347, 349
Cable, Speedometer.....	104
Cable, Temperature Control.....	128, 390
Cable, Throttle.....	457
Cable, Under Dash Parking Brake.....	146
Cable, Universal Parking Brake.....	147
California Emissions Decal.....	217
Caliper Seal Kit, Disc Brake.....	360
Caliper, Disc Brake.....	360-361
Cam, Turn Signal Cancelling.....	115
Camera, Inspection.....	400
Camshaft.....	412-413
Camshaft Bolts.....	412
Camshaft Thrust Buttons.....	412
Camshaft Wear Plate.....	412
Cam Holder.....	165
Cap / Hat.....	148, 157
Cap & Rotor, Distributor.....	434, 440
Cap, Fuel.....	452
Cap, Horn.....	136
Cap, Power Steering Pump.....	324
Cap, Radiator.....	379

Cap, Radiator Overflow Bottle.....	379
Cap, Splash Shield Screw.....	280
Cap, Subframe.....	317
Cap, Valve Stem.....	372
Cap, Wheel Center.....	364, 370
Cap, Windshield Washer Reservoir.....	321
Caps, Frame Rail.....	317
Car Care Product.....	5
Car Wax.....	4-5, 189
Car Cover Gust Guard.....	180
Car Polish.....	183, 187, 372-373
Car Sealant.....	187, 372-373
Car Wash Supplies.....	188, 190
Car Wax.....	183-186
CARB AIR Knul Decal.....	276
Carburetor.....	461-463, 466-467
Carburetor Accelerator Pump Squitter.....	467
Carburetor Adjustment Set.....	464
Carburetor Calibration Set.....	464
Carburetor Hardware.....	464
Carburetor Jets.....	467
Carburetor Linkage.....	462
Carburetor Manual.....	176
Carburetor Needle & Seat.....	467
Carburetor Power Valve.....	467
Carburetor Throttle Stud.....	463
Carburetor Wedge Plate.....	464
Card, Dealer Accessory Window.....	215
Card, Vehicle Warranty Information.....	215
Carpet.....	6-8
Carpet Dye.....	194
Carpet, Console.....	140-141
Carpet, Door Panel.....	122
Cassette Player, In-Dash.....	82
Catch, Glow Box.....	133
CD Changer.....	124
CD Player, In-Dash.....	122
Center Grill, Road Runner.....	264
Chamois.....	188
Charger, Headlamp Rotation Decal.....	215
Chocks, Wheel.....	191
Choke Assembly, Carburetor.....	462, 465
Choke Cover.....	446, 464
Chrome Water Neck.....	383
Chrysler Parts Decal.....	218
Circuit Boards, Printed.....	108
CirKit Boss.....	523
Clamp, Exhaust.....	477
Clamp, Power Steering Return Hose.....	326
Clamp, Radiator Hose.....	383
Clay Bar Kit.....	184
Clean Park Mat.....	191
Cleaner, Upholstery.....	183, 186
Cleaner, Wheel & Tire.....	187, 373
Clearance Tube, Exhaust Pipe.....	482
Cleco Sheet Metal Fastener Set.....	322
Clip, Console Side Trim.....	142
Clip, Convertible Top Binding End.....	300
Clip, Convertible Top Boot.....	300
Clip, Door Lock Rod Retaining.....	286
Clip, Door Panel Installation.....	82
Clip, Door Weatherstrip to Panel.....	230
Clip, Glove Box.....	133
Clip, Headliner Bow Mounting.....	87
Clip, Parking Brake Cable.....	147
Clip, Road Lamp Retaining.....	249
Clip, Seat Belt Retaining.....	65
Clip, Throttle Cable Retaining.....	457
Clip, Vinyl Top Molding.....	245
Clip, Window Release.....	242
Clip, Windshield Molding.....	242
Clips, Air Grabber Hose.....	277
Clips, Brake Line.....	359
Clips, Grill Screen.....	265
Clips, Hood Insulation.....	271
Clips, Windshield Molding.....	242
Cluck Cable Nut Tool, Rallye Dash.....	107
Cluck Delete Plate, Dash.....	105
Cluck Instruments, Digital.....	114
Cluck, Dash.....	105
Cluck, Rallye.....	106-107
Cluck Cable Nut Tool, Rallye Dash.....	142
Cluck Adjusting Rod.....	501
Clutch Belt Crank.....	500
Clutch Belt Crank Ball Stud.....	501

ORDER FORMS & INDEX 0

Product Index

Clutch Bell Crank Hardware.....	501
Clutch Disc.....	500
Clutch Fork.....	500
Clutch Linkage Service Set.....	501
Clutch Pedal Assembly.....	501
Clutch Pedal Bracket Retainer.....	501
Clutch Pedal Pad.....	145
Clutch Pedal Push Rod.....	501
Clutch Pedal Return Spring.....	501
Clutch Pedal Stop Bumper.....	501
Clutch Pilot Bushing.....	498
Clutch Pressure Plate.....	500
Clutch Rod Service Kit.....	500-501
Clutch <i>Z-Bar</i>	500
Coffee Mug.....	148
Coil Mounting Bracket, Ignition.....	439
Coil Wire.....	435
Coil, Ignition.....	434, 438
Coil, Steering Column.....	141, 135
Color Bar, Radio.....	126
Column Drop, Steering.....	134
Combination Valve, Brake.....	354
Compression Tester	400
Condenser, AC.....	388
Condenser, Ignition.....	440
Conduit, Wiring	446
Connector Set, Exhaust.....	472
Connector, Parking Brake.....	517
Connector, Turn Signal Switch.....	142
Connector, Windshield Washer.....	321
Connectors, Subframe.....	316
Console Ash Tray.....	142
Console Ash Tray Door.....	140, 142
Console Base.....	141-142
Console Body.....	141, 142
Console Box Top Rear Trim.....	140, 142
Console Carpet.....	140-141
Console Door.....	140
Console Door Hinge.....	140
Console Insert, Woodgrain.....	140, 142
Console Lamp.....	140-141
Console Lamp Lens.....	141
Console Lock.....	140
Console Mounting Bracket.....	140, 142
Console Shift Lever.....	140, 142
Console Shifter.....	494
Console Shifter Lens.....	140, 142
Console Shifter Outer Trim Plate.....	140, 142
Console Shifter Slide.....	140, 142
Console Side Cover.....	141
Console Side Trim.....	141
Console Tachometer Gauge.....	141
Console Top Plate.....	140, 142
Console Trim.....	140
Console Wiring Harness.....	142
Control Arm.....	331
Control Arm Ball Joint.....	329
Control Arm Bump Stop.....	332
Control Arm Bushing.....	329
Control Arm Mount.....	316
Control Arm Reinforcements.....	316
Control Arm Shaft, Upper.....	329
Control Unit Mounting Bracket.....	439
Conversion Harness, Elec. Ignition.....	439
Conversion, Brake.....	344-345, 350-351
Conversion, Engine.....	359
Conversion, Engine Swap Mount Kit.....	396
Conversion, Slap-Stik to Pistol Grip.....	494
Convertible Belt Molding.....	300
Convertible Boot Retainer.....	300
Convertible Caution Decal.....	217
Convertible Door Alignment Wedges.....	232
Convertible Header Seal.....	232
Convertible Pillar Post Weatherstrip.....	232
Convertible Rear Side Panel	66
Convertible Top.....	298
Convertible Top Actuator Cylinder.....	301
Convertible Top Binding End Clip.....	300
Convertible Top Boot.....	299
Convertible Top Boot Clip.....	300
Convertible Top Boot Storage Bag.....	300
Convertible Top Bumper Retainer Seal.....	232
Convertible Top Hydraulic Hose.....	301
Convertible Top Latch.....	300
Convertible Top Motor Grommet.....	301

Convertible Top Motor/Pump.....	301
Convertible Top Pad.....	300
Convertible Top Rear Window.....	298
Convertible Top Seals.....	234
Convertible Top Switch.....	301
Convertible Top Weatherstrip.....	232
Convertible Transition Molding	300
Convertible Wind Liners.....	298
Convertible Wheel Deflector.....	300
Coolant.....	383
Coolant Reserve Decal.....	211
Coolant System Protector.....	383
Coolant Warning Decal.....	211
Cooler/Filler, Transmission Oil	490
Cooling Fan Control.....	380
Cooling Fan Shutdown.....	380, 522
Cooling System Zinc Anode.....	382
Core Support, Radiator.....	267
Cover, Front Emblem	134
Coupler, Steering.....	134
Courtesy Lamp Bulb.....	250
Courtesy Lamp Lens.....	88
Cover, Back-Up Lamp Socket	258
Cover, Console Side.....	141
Cover, Differential.....	342
Cover, Fender.....	180
Cover, Floor Wiring	302
Cover, Gauge Light Bulb.....	135
Cover, Lower Steering Column	121
Cover, Seat Belt Mounting.....	321
Cover, Spare Hinge.....	56
Cover, Seat Tire.....	313
Cover, Sun Visor Bracket.....	91
Cover, Timing.....	408
Cover, Fender.....	180
Covers, Pedal.....	145
Covers, Valve.....	414-415, 427
Cowl Drain Flap.....	283
Cowl Hinge Panel.....	282-283
Cowl Panel Grill.....	283
Cowl Panel, Lower.....	282-283
Crank Handle, Window.....	84
Crankcase Evacuation System	415
Crankshaft Key.....	406
Crankshaft Oil Slinger.....	406
Crankshaft Pulley.....	405
Crate Engine.....	392-395
Creeper Stool.....	190
Cross Member, Torsion Bar	304
Cross Rail Extensions, Rear.....	319
Cross Rail, Rear.....	319
Crossmember Shock Mount, Rear.....	319
Crossover X-Pipe, Exhaust	483
Cruise Control Decal.....	211
Crush Sleeves, Pinion.....	341
Cushion, Bumper Guard.....	362
Cutout Pipes, Exhaust.....	478
Cutout Switch, Battery.....	508
Cylinder Head Gaskets.....	411
Cylinder Head Hardware.....	411
Cylinder Head, Engine.....	410

D	
Dana Axle Identification Decal.....	217
Dash Bezel	100-103
Dash Clock	105
Dash Clock Delete Plate	105
Dash Emblem	130, 203
Dash Gauge Indicator Lens.....	103
Dash Gauge Lens.....	103
Dash Gauges.....	121
Dash Ignition Lamp.....	133
Dash Knob.....	130
Dash Pad	98-99
Dash Panel Trim, Lower.....	101-102
Dash Reset Knob.....	103
Dash Reset Knob Cable.....	103
Dash Speaker Grill.....	124
Dash Trim	101
Dash Vent.....	128
Dash Vent Cable.....	128
Dash Vent Hose.....	215
Dealer Accessory Window Card.....	218
Decal Application Gel	224

Decal Applicator	224
Decal Sets, Gauge.....	108-109
Decal, Air Cleaner Instruction.....	210
Decal, Air Cleaner Lid.....	210
Decal, Air Conditioning.....	213
Decal, Air Grabber.....	208, 210
Decal, Alternator Inspection.....	211
Decal, Antifreeze.....	211
Decal, Battery.....	212-213
Decal, Brake Booster.....	214
Decal, CARB AIR Knob.....	276
Decal, Charger Headlamp Rotation.....	215
Decal, Chrysler Parts.....	218
Decal, Convertible Caution.....	217
Decal, Coolant Reserve.....	211
Decal, Coolant Warning.....	211
Decal, Cruise Control.....	211
Decal, Dana Axle Identification.....	217
Decal, Deck Lid.....	209
Decal, Differential Warning.....	217
Decal, Direct Connection.....	218
Decal, Door Post.....	215
Decal, Electronic Ignition.....	212
Decal, Emissions.....	212, 217
Decal, Fender.....	208-209
Decal, Fog/Road Lamp Wire.....	214
Decal, Fuel Filter.....	211
Decal, Glove Box.....	214
Decal, Header Panel.....	208
Decal, Hood.....	208-209
Decal, Horn Button.....	208
Decal, Jack Base.....	217
Decal, Jack Instruction.....	216
Decal, Max Wedge Shipping.....	215
Decal, Mopar.....	218
Decal, New Car Window Sticker.....	217
Decal, Objects In Mirror Are Losing	218
Decal, Oil Filter.....	211
Decal, Power Steering Pump.....	211
Decal, Quarter Panel.....	208
Decal, Ramcharger Air Box.....	210
Decal, Ramcharger Air Door.....	208
Decal, Rocker Molding	209
Decal, Rust Resistor.....	211
Decal, Satellite, C/OV The Year.....	215
Decal, SAT PACK Window.....	208, 218
Decal, Seat Belt.....	215
Decal, Shaker.....	210
Decal, Space Saver Tire.....	217
Decal, Spare Tire Inflator Bottle.....	217
Decal, Spoiler.....	209
Decal, Super Bee.....	208, 218
Decal, Tail Panel.....	224
Decal, Thermostat.....	211
Decal, Tire Pressure.....	216
Decal, Unleaded Fuel Only.....	211
Decal, Vacuum Advance.....	211
Decal, Valve Cover.....	210
Decal, Warm Climate.....	211
Decal, Western Sport Special.....	218
Decal, White Bear Dodge.....	209
Decal, Windshield Washer.....	211
Decals, Duster.....	209
Decals, Road Runner.....	208-209
Deck Filler Patch Panel	291
Deck Lid, Upper Plenum.....	209
Deck Lid Decal.....	209
Deck Lid Emblem.....	204-205
Deck Lid Latch Link	308
Deep Dish Wheel Trim Ring	365
Deep Dish Wheel, Dash Clock.....	105
Dent Removal Tool.....	322
Detailing Brushes.....	188-189, 366
Detailing Supplies.....	187-189
Differential.....	341
Differential Bearing.....	342
Differential Cover.....	342
Differential Cover Filter/Mag.....	343
Differential Cover Gasket.....	342
Differential Holding Fixture	342
Differential Housing.....	342
Digital Gauges, Instruments.....	112-114
Digital Gauges.....	112-113
Digital Power Manager.....	523
Dimmer Switch Pedal.....	143

Product Index

Dimmer Switch, Gauge LED.....	121
Dipstick, Oil.....	431
Dipstick, Transmission.....	490
Direct Connection Decal.....	218
Disc Brake Caliper.....	360-361
Disc Brake Caliper Seal Kit.....	360
Disc Brake Conversion.....	344-351
Disc Brake Master Cylinder.....	347
Disc Brake Metering Valve.....	351-352
Disc Brake Pads.....	360-361
Disc Brake Rotor.....	360-361
Disc Brake Spindle.....	331, 348
Disc Brake Splash Shield.....	360
Disc, Clutch.....	501
Disconnect Position Ring.....	208
Distribution Block, Brake.....	354
Distributor.....	434-437, 439
Distributor Advance Curve Set.....	440
Distributor Advance Weight Spring.....	440
Distributor Gears.....	441
Distributor Hold Down Bracket.....	440
Distributor Mounting Gasket.....	440
Distributor Parts.....	436-437, 440-441
Dome Lamp Assembly.....	88
Dome Lamp Bezels.....	88
Dome Lamp Dimmer Module.....	88
Dome Lamp Lens.....	88
Door.....	285
Door & Quarter Panel Frame.....	292
Door Aligning Bar.....	286
Door Alignment Wedges, Convertible.....	232
Door Bumper.....	232-233
Door Edge Guard.....	191
Door Emblem.....	202-203
Door Frame Weatherstrip.....	230
Door Glass Guides.....	289
Door Glass Weatherstrip.....	229
Door Handle Push Button, Outer.....	288
Door Handle, Outer.....	83
Door Handle, Outer.....	288
Door Hangar Tool.....	286
Door Hinge.....	286
Door Hinge Adjuster Tool.....	286
Door Hinge Bolt Set.....	286
Door Hinge Pillar.....	285
Door Hinge Rebuild Set.....	286
Door Hinge Spring.....	286
Door Jamb Lock Pillar.....	285
Door Jamb Repair Plate.....	285
Door Jamb Seal Screw.....	230
Door Jamb Switches.....	88
Door Jamb U-Seal.....	230
Door Latch.....	286
Door Latch/Lock Clip Set.....	286
Door Lock.....	132
Door Lock Ferrule.....	83
Door Lock Knob.....	83
Door Lock Link Rod.....	288
Door Lock Rod Retaining Clip.....	286
Door Lock Striker.....	286
Door Mirror Mounting Set.....	287
Door Mirror, Outer.....	287
Door Pad, Upper.....	79
Door Panel Carpet.....	82
Door Panel Emblem.....	82
Door Panel Insert, Woodgrain.....	82
Door Panel Installation Clip.....	82
Door Panel Remover Tool.....	71
Door Panel Vent Plug.....	82
Door Panels, Interior.....	66-80
Door Pins, Fresh Air Trap.....	277
Door Post Decal.....	215
Door Seal Weatherstrip, Colored.....	230
Door Shell.....	285
Door Sill Plate.....	285
Door Skin, Outer.....	285
Door Top Edge Molding.....	243
Door Weatherstrip to Panel Clip.....	230
Door Window Glass.....	237
Door Window Hardware.....	289
Door Window Regulator.....	289
Door Window Roll-Over.....	289
Door Window Weatherstrip Plug.....	229
Door, Console.....	140
Door, Console Ash Tray.....	140, 142

Dowel Pins, Engine Block to Head.....	411
Drag Racing Parts Catalog.....	170
Drain Rail, Cowl.....	283
Drier, A/C.....	389
Drip Rail Foam Strips.....	290
Drip Rail Molding.....	244
Drive Shaft Safety Loop.....	340
Driveshaft, Oil Pump.....	431
Driveshaft, U-Joint.....	343
Drivetrain Manual.....	177
Drum Brake Adjusting Tool.....	355
Drum Brake Hardware.....	362-363
Drum Brake Shoes.....	362
Drum Brake Wheel Cylinder.....	362
Drum, Brake.....	363
Dual Battery Control System.....	523
Dual Quat Carb. Intake Manifold.....	418
Duct, Fresh Air Box.....	276-277
Dust Cap, Brake Bleeder Screw.....	359
Dust Shield, Starter.....	449
Dust Shield, Transmission.....	490
Duster Decals.....	209
DVD, Automotive.....	179

E

EFI Fuel Return Adapter.....	463
EFI System.....	463
Elastomeric Bumper, Barracuda.....	261
Electric Radiator Fan.....	381
Electric Radiator Fan Temp. Sender.....	381
Electric Tools.....	508-513
Electronic Brake Master Cylinder.....	351
Electronic Diagnostic Tool.....	401
Electronic Disc Brake Conversion Kit.....	351
Electronic Ignition Control Module.....	438-439
Electronic Ignition Conversion Kit.....	438-439
Electronic Ignition Decal.....	212
Electronic Vacuum Pump.....	354
Emblem Adhesive.....	207
Emblem Attachment Tape.....	207
Emblem, Door.....	202-203
Emblem, Door.....	202-203
Emblem, Door Panel.....	82
Emblem, Engine Size.....	207
Emblem, Fender.....	200-202, 207
Emblem, Grill.....	198-199
Emblem, Header Panel.....	199-200
Emblem, Headlamp Door.....	198
Emblem, Hood.....	199-200
Emblem, Hood Engine Call-Out.....	272
Emblem, Hurst.....	207, 497
Emblem, Noose.....	199
Emblem, Quarter Panel.....	203
Emblem, Rear Finish Panel.....	206
Emblem, Rear Panel.....	204
Emblem, Seal.....	57
Emblem, Seat Pad.....	206
Emblem, Steering Wheel.....	136, 139
Emblem, Tail Panel.....	206
Emblem, Trunk Lid.....	204-205
Embroidered Patch.....	148
Emergency Brake Cable Tag.....	217
Emergency Brake Handle.....	128
Emission Control Wiring Harness.....	516
Emission Duct Hose, Universal.....	419
Emissions Decal.....	212
Engine.....	392-395
Engine Airflow Manual.....	175
Engine Bay Paint.....	195
Engine Bolt Set.....	409
Engine Break-In Oil.....	433
Engine Break-In Tag.....	214
Engine Dress-Up Kit.....	415
Engine Freeze Plug.....	407
Engine Gasket Set.....	407
Engine Manual.....	170, 174-175
Engine Paint.....	195
Engine Power Package Top End Kit.....	411
Engine Size Emblem.....	207
Engine Starting Tag.....	214
Engine Swap Motor Mount Kit.....	396
Engine To Firewall Ground Cable.....	507
Engine Weir Harness.....	515-516, 522
Evaporator Core, AC.....	388

Exhaust Clamp.....	477
Exhaust Crossover X-Pipe.....	483
Exhaust Cutoffs, Electric.....	478
Exhaust H-Pipe.....	474
Exhaust Headpipe.....	475
Exhaust Intermediate Pipe.....	475
Exhaust Manifold.....	469
Exhaust Manifold Hardware.....	469
Exhaust Paint.....	195, 471
Exhaust Pipe Clearance Tube.....	482
Exhaust Pipe Cutter Tool.....	471
Exhaust Repair.....	471
Exhaust Side Pipe Boom Tube.....	483
Exhaust System.....	474, 477, 483
Exhaust Tailpipe.....	475
Exhaust Tip.....	482, 484
Exhaust Tip Hanger.....	485
Exhaust Tip Q-Clamp.....	477
Exhaust Turn-Downs.....	478
Exhaust X-Pipe.....	475
Exhaust Y-Pipe.....	475

F

Fan Controller.....	381
Fan Relay.....	381
Fan Shroud.....	377, 380
Fan, Radiator.....	380-381
Fastener, Firewall Insulation.....	10
Fastener, Shaker Hood Bubble.....	276
Fender.....	278
Fender Bolt Set.....	279
Fender Brace.....	278
Fender Covers.....	180
Fender Decal.....	208-209
Fender Emblem, Conversion.....	200-202, 207
Fender End Molding.....	239
Fender Gills.....	243
Fender Mounted Turn Signal.....	251
Fender Mounted Turn Signal Gaskets.....	251
Fender Scoop Inserts.....	279
Fender Side Molding.....	239
Fender Splash Shield Hardware.....	280
Fender To Cowl Brace.....	280
Fender/Door Trim.....	243
Ferrules, Door Lock Knob.....	83
Filler Neck Grommet.....	452
Filler Panel, Rear Outer.....	291
Filler Spout.....	433
Filler Element, Air.....	420-427
Filler, Fuel.....	456-457
Filter, Oil.....	432
Filter/Cooler, Transmission Oil.....	490
Firewall Clutch Boot.....	501
Firewall Gaskets.....	234
Firewall Insulation Fastener.....	10
Firewall Panel.....	282-283
Firewall Washer Grommet.....	321
Fitting, Brake Line.....	358
Fitting, Heater Hose.....	383
Flapper Door, Fresh Air.....	277
Flasher, LED Lamp.....	257
Flashlight, LED Rechargeable 12V.....	191
FlatStoppers, Tire Storage Pads.....	191
Flexplate, Transmission.....	487
Floor Bowl Screw Set, Six Pack.....	465
Floor Extension, Trunk.....	307
Floor Filler Board, Trunk.....	313
Floor Mats.....	12-17
Floor Mount Shifter.....	496
Floor Pan.....	302-303
Floor Pan Brace, Rear.....	311
Floor Pan Repair Panel, Rear.....	304-305
Floor Panel, Trunk.....	306
Floor Reinforcements, Bucket Seat.....	55
Floor Support Brace.....	302
Floor Wiring Cover.....	302
Fluid, Manual Transmission.....	408
Fluid, Power Steering.....	324
Fluylwheel.....	499-500
Foam Strips, Drip Rail.....	290
Fog Lamp Wire Decal.....	214
Foot Rest Pedal.....	143
Fork, Clutch.....	500

Product Index

Frame Rail	316
Frame Rail Caps	317
Frame, Door and Quarter Panel	292
Frame, Seal	55
Frame, Vent Window Glass	242
Freeze Plug, Engine	407
Fresh Air Box Duct	276-277
Fresh Air Box Seal	277
Fresh Air Duct Assembly, N96	276
Fresh Air Duct Mounting Hardware	276
Fresh Air Flapper Door	277
Fresh Air Handle & Cable	276
Fresh Air Switch	277
Fresh Air Switch Bracket	277
Fresh Air Trap Door	277
Fresh Air Trap Door Pins	277
Fresh Air Trap Door Seal	271
Fresh Air Vacuum Canister, N96	277
Fresh Air Vacuum Hose Set, N96	277
Fresh Air Vent Seal, N96	277
Front Air Dam	266
Front Bumper	260
Front Bumper Filler Seal	262
Front Bumper Guard	260
Front Bumper Lower Stone Shield	266
Front Disc Brake Hose Bracket	358
Front Disc Brake Kit... 336, 344-346, 348, 350-351	
Front Fender	278
Front Fender Molding	239
Front Fender Splash Shield	280
Front Floor Pan Repair Panel	303
Front Inner Fender	279
Front Inner Fender Plate	279
Front Lamp & Engine Harness	517
Front Lamp Wiring Harness	517-518
Front Leaf Spring Brackets	318
Front Shock	337
Front Spoiler	190, 266
Front Spoiler Mounting Hardware	266
Front Spring Hanger Gussets	318
Front Stabilizer Link Bushing Set	334
Front Sway Bar	333
Front Sway Bar Brackets	332
Front Valve Filler	266
Front Valve Molding	239
Front Valve Panel	266
Fuel Additive	464
Fuel Cap	452
Fuel Cooler Tank	460
Fuel Door Bumper	232-233
Fuel Filter	456-457
Fuel Filter Decal	211
Fuel Gauge	105-107
Fuel Hose	456
Fuel Injection Manual	176
Fuel Injection System	463
Fuel Line	453-455, 459, 462
Fuel Line Clip Set	456
Fuel Pressure Gauge	460
Fuel Pressure Regulator	460
Fuel Pressure Tester	400
Fuel Pump	458-459
Fuel Pump Relay	459-460
Fuel Pump Safety Switch	460
Fuel Pump Vacuum / Pressure Tester	460
Fuel Sending Unit	115
Fuel System	459, 463
Fuel System Cleaner	460
Fuel Tank	450-451
Fuel Tank Filler Neck	452
Fuel Tank Insulation Pad	451
Fuel Tank Mounting Strap	451
Fuel Tank Sending Unit	458
Fuel Tank Vent Line	458
Fuel Vapor Line Bulkhead	458
Fuse Block	523
Fuse Panel, Modular System	514
Fuse Tap/Fuse Holders	509
Fuses	511
Fusible Link Tags	213
Fusible Links	518

G

Gapper, Spark Plug	441
--------------------	-----

Gapper/Feeler Gauge Set	441
Gas Cap	452
Gas Tank	450-451
Gas Tank Anti-Squeak Felt	451
Gasket Set, Engine	407
Gasket Set, Intake Manifold	418-419
Gasket Set, Paint	235
Gasket, Air Cleaner Base	421
Gasket, Back-Up Retainer	341
Gasket, Back-Up Lens	259
Gasket, Differential Cover	342
Gasket, Distributor Mounting	440
Gasket, Fender/Hood Indicator	251
Gasket, License Plate Lamp Lens	259
Gasket, Master Cylinder	353
Gasket, Oil Pan	430-431
Gasket, Outer Door Handle	288
Gasket, Park Lamp Lens	253, 264
Gasket, Seat Headrest	57
Gasket, Side Marker Lamp	255
Gasket, Tail Lamp	258
Gasket, Tail Lamp Bezel	235
Gasket, Tail Lamp Lens	256
Gasket, Timing Cover	409
Gasket, Wiper Motor	320
Gaskets, Cylinder Head	411
Gaskets, Firewall	234
Gaskets, Hood Insert	234, 272
Gaskets, Hood Scoop	234, 272
Gaskets, Quarter Extension	234
Gaskets, Rear Spoiler	309
Gaskets, Valve Cover	416
Gaskets, Wiper Pivot	320
Gauge Decal Sets	108-109
Gauge Light Bulb Cover	121
Gauge Set, Rallye	106-107
Gauge, Ammeter	106-107
Gauge, Amperage	105
Gauge, Console Tachometer	141
Gauge, Fuel	105-107
Gauge, Fuel Pressure	460
Gauge, Oil Pressure	106-107
Gauge, Speedometer	104-105
Gauge, Tachometer	104-105
Gauge, Temperature	105-107
Gauges, Performance	110-121
Gear Box, Manual Steering	328
Gear Box, Power Steering	326
Gear Oil	343
Gear, Distributor	441
Gear, Speedometer	104
Gearshift Button	494
Gearshift Control Torque Bracket	494
Generator	447
Genuine Dodge Parts Decal	218
Glass, Adhesive	237
Glass Cleaner	186
Glass Guides, Door	289
Glass Up Stop	289
Glass, Back Window	236
Glass, Box Window	237
Glass, Quarter Window	237
Glass, Vent Window	236
Glass, Windshield	236
Glasspack Muffler	479
Glove Box Catch	133
Glove Box Clip	133
Glove Box Decal	214
Glove Box Door Bumper	232
Glove Box Lamp Bulb	133, 250
Glove Box Lamp Lens	133
Glove Box Liner	133
Gloves, Mechanic	148
GPS Locator	180
GPS Security System	180
Graphics & Stripes	219-227
Grilles, Polyurethane Bushing	335
Grill	263-265
Grill & Headlamp Support	267
Grill Bar Set	238, 265
Grill Emblem	198
Grill Hardware Set	264-265
Grill Insert	238
Grill Molding	238-239, 264
Grill Screen Clips	265

Grill Spacer Set	263
Grill, Cow Panel	283
Grill, Dash Speaker	124
Grommet, Convertible Top Motor	401
Grommet, Distributor Wire	441
Grommet, Filler Neck	452
Grommet, Firewall Washer	321
Grommet, Rear Shock Absorber	337
Grommet, Heater Core	390
Gross Straps, Shaker	276
Guard, Door Edge	191
Guard, Rear Bumper	261
Guide, Parking Brake Cable	147
Guide, Seat Belt	65

H

H4 Adapter Plug Set With Wires	250
Handle, Emergency Brake	128
Handle, Interior Door	83
Handle, Outer Door	288
Handle, Slap-Stik Shifter	494
Handle, Window Crank	84
Hanger, Muffler	485
Hanger, Tailpipe	485
Hanger, Wheel & Tire	372
Hardware, Cylinder Head	411
Hardware, Drum Brake	362-363
Hardware, Front Spoiler Mounting	266
Hardware, Grill	264
Hardware, Jack Mounting	314
Hardware, Park Lamp	264
Hardware, Radiator Fan Shroud	380
Hardware, Starter Mounting	449
Hardware, Steering Wheel	139
Hardware, Tail Molding Mounting	417
Hardware, Valve Cover	416
Harmonic Balancer	406
Harness, Gauge	121
Harness, Headlamp	121
Hat / Cap	148-149, 156-157
Hat / Lapel Pin	148, 149
Head Bolt Set	411
Head Spacer Bolt	448
Head, Engine Cylinder	410
Header Panel	267
Header Panel Bolt Set	267
Header Panel Decal	208
Header Panel Emblem	199-200
Header Wrap	470
Headers	468
Headlamp	248
Headlamp & Grill Support	267
Headlamp Adjuster Set	249
Headlamp Back Plates	278
Headlamp Bezel	263
Headlamp Brackets	278
Headlamp Bulb	248, 250
Headlamp Door Actuator	249
Headlamp Door Emblem	198
Headlamp Door Vacuum Canister	249
Headlamp Door Vacuum Switch	249
Headlamp H4 Conversion Harness	249
Headlamp Housing	249
Headlamp Switch/Wiring	249
Headlamp Splash Shields	267
Headlamp Switch	130
Headlamp Switch Bezel Nut Tool	130
Headlamp Switch Knob	130
Headliner	86-87, 93
Headliner Board	87
Headliner Bow	87
Headliner Bow Mounting Clip	87
Headliner Installation Glue	87
Headliner Insulation	87
Headliner Tool	87
Headrest Bezel	57
Headrest, Seat	57
Heat Riser Tube	469
Heat Shield, Muffler	472
Heat Shield, Spark Plug Wire	444-445
Heat Shield, Starter	390
Heater Box Clips	390
Heater Box Restoration Set	390

Product Index

Heater Box Screws.....390
 Heater Box to Cowl Seal.....391
 Heater Bypass Valve.....389
 Heater Control Bezel.....129
 Heater Core.....390
 Heater Core Housing Cover.....390
 Heater Hose.....391
 Heater Hose Bracket.....391
 Heater Hose Fitting.....383
 Heater Hose Tie Strap.....391
 Heater/Defrost Cable.....128
HEI Battery/Tach Pigtail.....440
 Hemi Service Bulletins.....170
 Hinge Bushing, Brake & Clutch.....142
 Hinge Cover, Seat.....56
 Hinge Panel, Cowl.....282-283
 Hinge, Air Grabber Door.....277
 Hinge, Console Door.....140
 Hinge, Door.....286
Hinge, Hood.....269
 Hinge, Trunk Lid.....308
 Hog Ring Pliers.....45, 49
 Hog Rings.....45, 49
 Hole Cutter.....323
 Hole Thread Chaser, Spark Plug.....441
 Holley Carburetors Manual.....176
 Hood.....268
 Hood Adjust Bumper.....232
 Hood Decal.....208-209
 Hood Door Seals, N96.....234
 Hood Emblem.....199-200
 Hood Engine Call-Out Insert.....272
 Hood Frame, Fresh Air Opening.....277
Hood Hinge.....269
 Hood Insert.....272
 Hood Insert Gaskets.....234, 272
Hood Insulation.....271
 Hood Insulation Clips.....271
 Hood Latch.....269
 Hood Letter Emblem.....199
Hood Lip Molding.....239
 Hood Louver Molding.....272
 Hood Mounted Turn Signal Assembly.....251
 Hood Mounted Turn Signal Gaskets.....251
 Hood Ornament.....199
 Hood Pin.....181, 270
 Hood Pin Bracket.....270
 Hood Release Cable.....128
Hood Scoop.....273-275, 422
 Hood Scoop Bezel.....273
 Hood Scoop Gaskets.....234
Hood Scoop Mounting Hardware.....273
 Hood Scoop To Air Filter Seal.....421
 Hood Spring.....269
 Hood Stop Bumper.....232
 Hood To Baseplate Seal.....421
 Hood To Cowl Seal.....228
Hood To Radiator Seal.....228
 Hood Wedge.....269
 Hook, Parking Brake Cable.....139
 Horn.....139
 Horn Button.....139
 Horn Button Decal.....208
Horn Cap.....136
 Horn Insert, Rim-Blow.....136
 Hose Clamp, Octiker.....456
 Hose, Air Cleaner Breather.....419
 Hose, Brake.....359
 Hose, Convertible Top Hydraulic.....301
 Hose, Dash Vent.....128-129
 Hose, Fuel.....456
 Hose, Heater.....391
 Hose, Power Steering.....326
 Hose, Radiator Overflow.....379
 Hose, Stainless Steel Brake.....346
 Hose, Windshield Washer.....321
Housing, Back-Up Lamp.....259
Housing, Brake Lamp.....104
 Housing, Differential.....342
 Housing, Headlamp.....249
 Housing, Instrument Cluster.....103
 Housing, Park Lamp.....253
 Housing, Speaker and Rear Defroster.....125
 Housing, Tail Lamp.....257
Hub Cap, Dog Dish.....364

Hurst Emblem.....207
 Hurst Roll/Control Set.....489
 Hurst Shifter.....497, 502
 Hurst Shifter Control Set.....502
 Hurst Shifter Linkage Bushing/Clip.....502
 Hustle Stuff Performance Catalog.....170
 Hydraulic Brake Switch, Low Pressure.....353

I

Idle Control Solenoid Harness.....518
 Idle Screw Cap.....465
 Idle Solenoid.....465
 Idle Solenoid Bracket, Six Pack.....465
 Idle Stop Solenoid Harness.....518
 Idler Arm.....328, 330
 Ignition Coil.....434, 438-439
 Ignition Coil Mounting Bracket.....439
 Ignition Condenser.....440
Ignition Control Module.....418, 434, 438-439
 Ignition Lock.....132
 Ignition Points.....440
 Ignition Switch.....131
 Ignition Switch Bezel.....131
 Ignition Switch Bezel Nut Tool.....131
 Ignition Wire Loom Set.....443
 Ignition Wire Separators.....444
 Ignition, Remote Controlled.....181
 Inner Fender Bracket.....280
 Inner Fender, Front.....279
 Inner Rocker Panel.....284
 Inner Tie Rod End.....328
 Inner Wheelhouse Panel.....295
 Insert, Air Grabber.....276
 Insert, Grill.....238
 Insert, Hood.....272
 Insert, Hood Engine Call-Out.....272
 Insert, Pistol Grip Shift Pattern.....502
 Insert, Rim-Blow Horn.....137
 Insert, Woodgrain Console.....140-142
 Insert, Woodgrain Door Panel.....82
 Inserts, Fender.....279
 Inserts, Wheel Center Cap.....367
Inspection Camera.....400
 Inspection Stamp.....182
 Instrument Bezel.....100-103
 Instrument Cluster Housing.....103
 Instrument Cluster Panel.....112-113
Instrument Cluster Voltage Limiter.....104
 Instrument Panel Bulb.....250
Insulation.....193
 Insulation, Hood.....271
 Insulation, Interior.....11
 Insulation, Kick Panel.....81
 Insulation, Package Tray.....97
 Insulation, Thermal.....472-473
 Insulation, Trunk Divider.....97
 Insulation, Under Dash.....128
 Insulator, Battery Cable.....509
 Intake Manifold.....418, 427
 Intake Manifold Gasket Set.....418-419
 Intake Manifold Hardware Set.....419
 Interior Door Panel.....80
 Interior Insulation.....11
 Interior Panel Paint.....194
Interior Rear View Mirror.....94
 Interior Restoration Guide Manual.....179
 Interior Seals Set.....95
 Interior Trim Retainer.....291
 Interiors Manual.....179
 Isolators, Add-On.....523

J

Jack Base Decal.....217
 Jack Instruction Decal.....216
 Jack Mounting Hardware.....311
 Jacket, Apparel.....149
 Jar, Windshield Washer Reservoir.....321
 Jets, Carburetor.....467

K

Key Removal Tag.....214

Keychain.....148-149, 165
Keyless Entry System.....181
 Kick Panel.....81
 Kick Panel Installation.....81
 Kick Panel Speakers.....126
 Kickdown Cable.....492-493
 Knob Assembly, Automatic Shifter.....494
 Knob, Custom Pistol Grip Shifter.....502
 Knob, Dash.....130
 Knob, Dash Reset.....103
 Knob, Door Lock.....83
 Knob, Headlamp Switch.....130
 Knob, Manual Transmission Shifter.....493
 Knob, Radio.....124
Knob, Seat Release.....57
 Knob, Wiper Switch.....131

L

Lamp Set, Odometer.....109
 Lamp, Console.....141
 Lamp, Dash Indicator.....133
 Lamp, Map.....133
Lanyard.....149, 165
 Label Pin.....149
 Latch Assembly, Quarter Window.....145
 Latch, Convertible Top.....300
 Latch, Door.....286
 Latch, Hood.....269
 Latch, Quarter Window.....245
 Latch, Seat.....272
 Latch, Trunk Lid.....308
 Leads, Distributor.....441
Leaf Spring Bushing Set.....339
 Leaf Spring Liner.....338
Leaf Spring Mount.....318-319
 Leaf Spring Pad.....338
 Leaf Spring Rebuild Set.....338
 Leaf Spring, Rear.....338
Leather Upholstery Cleaner.....133
 LED Bulb.....121
 LED Headlamp.....248
LED Lamp Flasher.....257
 LED Rechargeable 12V Flashlight.....133
 Lens, Back-Up Lamp.....258-259
 Lens, Console Lamp.....141
 Lens, Console Shifter.....140, 142
 Lens, Courtesy Lamp.....88
 Lens, Dash Gauge.....103
 Lens, Dome Lamp.....88
 Lens, Glove Box Lamp.....133
 Lens, License Lamp.....259
 Lens, Map Lamp.....133
Lens, Park Lamp.....252-253, 264
 Lens, Rally Gauge.....103
 Lens, Side Marker Lamp.....254-255
 Lens, Speedometer.....103
 Lens, Tail Lamp.....256
 License Plate.....148, 167
 License Plate Bracket.....259
 License Plate Bumper.....232-233
License Plate Installation Nut.....259
 License Plate Lamp Bulb.....249, 250
 License Plate Lamp Lens.....259
License Plate Lamp Lens Gasket.....259
 License Plate Spring.....259
 Lid, Air Cleaner.....277, 420, 426
 Light, Shift.....121
 Limited Slip Differential.....342
 Line, Transmission Cooler.....491
Linkage, Throttle.....179
 Literature, Automotive.....168-179
 Lock Conversion, Power Trunk.....311
 Lock Strip, Rear Window.....231
 Lock Strip, Windshield.....228
 Lock, Console.....140
 Lock, Door.....132
 Lock, Ignition.....132
 Lock, Trunk.....132
 Lower Body Side Molding.....243
 Lower Column Seat Retainer.....135
 Lower Control Arm Ball Joint.....329
 Lower Control Arm Bushing.....329
 Lower Cowl Panel.....282-283

ORDER FORMS & INDEX

Product Index

Lower Rear Quarter Patch Panel..... 294-295
 Lower Rear Window Frame..... 290
 Lower Shift Tube Bearing..... 135
 Lower Steering Column Bearing..... 135
Lower Steering Column Cover..... 135
 Lower Trim Panels, Convertible Seat..... 59
Lug Nut, Wheel..... 368-369

M

Magnum 500 Wheel..... 364
 Magnum Wheel Center Cap..... 364
 Maintenance Manual, Muscle Car..... 179
 Manifold, Exhaust..... 469
 Manifold, Intake..... 418
 Manual Steering Gear Box..... 328
 Manual Transmission Fluid..... 498
 Manual Transmission Shift Knob..... 493
 Manual Transmission Shifter Rod Set..... 503
 Manual, Airbrush Painting..... 176
 Manual, Axle & Differential..... 177
 Manual, Bodywork..... 179
 Manual, Carburetor..... 176
 Manual, Dealer Shop..... 168-169
 Manual, Drivetrain..... 177
 Manual, Engine..... 170, 174-175
 Manual, Fuel Injection..... 176
 Manual, Holley Carburetors..... 176
 Manual, Interior Restoration Guide..... 179
 Manual, Muscle Car Maintenance..... 179
 Manual, Owner's..... 168
 Manual, Paint & Body..... 176
 Manual, Sheet Metal..... 178
 Manual, Shop..... 170
 Manual, Supercharging..... 176
 Manual, Transmission Repair..... 177
 Manual, Turbocharging..... 176
Manual, Welding..... 178
 Manual, Wiring..... 177
 Map Lamp..... 133
 Map Lamp Lens..... 133
 Master Cylinder Gasket..... 353
 Master Cylinder Mount..... 353
 Master Cylinder Pushrod..... 353
 Master Cylinder Tag..... 214
Master Cylinder, Brake..... 347, 351-352
 Master Disconnect, Remote..... 523
 Mats, Truck..... 312-313
 Max Wedge Shipping Decal..... 215
 McGard Lug Nut/Lock Kits..... 371
 Mechanic Gloves..... 148
 Memory Circuit Retainer..... 508
 Metal Signs..... 160, 164
Metering Valve, Disc Brake..... 354
 Mirror Bezel Nut Tool..... 287
Mirror, Interior Rear View..... 94
 Mirror, Outer Door..... 287
 Mirror, Rear View..... 94
 Mirror, Show..... 183
 Module, Dome Lamp Dimmer..... 88
 Module, Fuel Pump Safety Switch..... 460
 Module, Ignition Control..... 418
 Module, Radio Off Delay..... 125
 Molded Door Seal End Cap..... 231
 Molding Removal Tool..... 247
 Molding Set, Windshield..... 242
Molding, A-Pillar..... 89
Molding, Back Glass/Rear Window..... 244
 Molding, Convertible Belt..... 300
Molding, Convertible Boot Well..... 300
Molding, Door Top Edge..... 243
 Molding, Drip Rail..... 244
 Molding, Door Fender..... 239
 Molding, Front Valance..... 239
Molding, Grill..... 238-239, 264
Molding, Hood Lip..... 239
 Molding, Hood Louver..... 232
 Molding, Interior Rear Window..... 89
 Molding, Lower Body Side..... 243
 Molding, Pillar Post..... 89
 Molding, Quarter..... 245
 Molding, Rocker..... 243
 Molding, Sail Panel..... 245
 Molding, Tail..... 245-247

Molding, Tail Lamp..... 245
 Molding, Trunk Lid..... 246-247
Molding, Vinyl Top..... 245
Molding, Wheel Opening..... 240-241
Molding, Windshield..... 242
 Mopar Performance Parts Decal..... 218
 Mopar Police Wheels..... 366
 Mopar Window Decal..... 218
 Motor Mount, Vacuum Hose Set..... 397
 Motor, Starter..... 420
 Motor, Wiper..... 320
 Motor/Pump, Convertible Top..... 301
 Mount Pad, Outer Door Handle..... 288
 Mount, Control Arm..... 316
Mount, Leaf Spring..... 318-319
 Mount, Master Cylinder..... 353
 Mount, Transmission..... 492
 Mounting Bracket, Ignition Coil..... 439
 Mounting Strap, Fuel Tank..... 451
 Mounting Studs, Fuel Tank..... 451
Mounts, Vibration..... 434
 Mouse Pad..... 148
Muffler..... 476-483
 Muffler Heat Shield..... 472, 477
 Muffler Strap..... 477
 Mug, Coffee..... 148, 158

N

N96 Fresh Air Duct Assembly..... 276-277
 N96 Fresh Air Vacuum Canister..... 277
 N96 Fresh Air Vacuum Hose Set..... 397
 N96 Fresh Air Vent Seal..... 271
 Neutral Safety Switch Harness Tag..... 214
Neutral Safety Switch..... 494
 New Car Window Sticker..... 217
 New Vehicle Price Label..... 217
 Noise Filter..... 434
 Nose Cone Seal, Superbird..... 228
 Nose Emblem..... 199
 Nozzle, Fire Hose Type..... 189
 Nozzle, Windshield Washer..... 321
 Nut, Wheel Lug..... 368-369, 371

O

O-Ring Set, AC..... 389
 Odometer Label Set..... 109
 Oil..... 433
 Oil Cap..... 416
 Oil Cooler..... 432
Oil Cooler/Filter, Transmission..... 490
 Oil Dipstick..... 431
 Oil Drain Plug..... 431
 Oil Drain Plug, Transmission..... 489
 Oil Filter..... 432
 Oil Filter Cover..... 432
 Oil Filter Decal..... 411
 Oil Filter Magnets..... 432
 Oil Pan..... 427-429
Oil Pan Bolt Set..... 430-431
 Oil Pan Gasket..... 432
 Oil Pan Skid Plate..... 429
 Oil Pan Windage Tray..... 106-107
 Oil Pressure Gauge..... 431
Oil Pressure Switch Socket..... 431
 Oil Pump Driveshaft..... 431
 Oil Slinger, Crankshaft..... 406
 Oil, Engine Break-In..... 433
Outer Door Handle..... 288
 Outer Door Handle Gasket..... 288
 Outer Door Handle Mount Pad..... 288
 Outer Door Handle Push Button..... 288
 Outer Door Mirror..... 287
 Outer Door Mirror Mount Pad..... 287
Outer Door Skin..... 285
 Outer Rocker Panel..... 284
 Outer Tie Rod End..... 328
 Outer Wheelhouse Panel..... 295
 Overflow Bottle, Radiator..... 379
 Overhead Console Wiring Harness..... 520
 Owner's Manual..... 168
 Oxygen Sensor Fitting..... 469
Oxygen Sensor Plug..... 469

P

Package Tray..... 96
 Package Tray Insulation..... 70
Package Tray Panel Extension..... 70
 Pad, Accelerator Pedal..... 144
Pad, Arm Rest..... 85
 Pad, Brake Pedal..... 144-145
 Pad, Clutch Pedal..... 145
 Pad, Convertible Top..... 300
Pad, Dash..... 98-99
 Pad, Leaf Spring..... 338
 Pad, Outer Door Handle Mount..... 288
 Pad, Outer Door Mirror Mount..... 287
 Pad, Parking Brake Pedal..... 145
 Pad, Disc Brake..... 360-361
 Paint..... 196
 Paint & Body Manual..... 176
 Paint & Body Markers..... 182
Paint Gasket Set..... 235
 Paint Gauge..... 322
 Paint, Clear Gloss..... 197
 Paint, Engine..... 195
 Paint, Exhaust..... 196, 471
 Paint, Interior Panel..... 194
 Paint, Primer..... 196
 Paint, Rubber Undercoating..... 196
 Paint, Trunk..... 197, 313
 Paint, Underhood..... 197
 Paint, Wheel..... 197
 Paint, Wrinkle..... 196
 Pan, Automatic Transmission..... 487, 490
 Pan, Floor..... 302-303
 Pan, Oil..... 427-429
 Panel Skin, Roof Patch..... 290
Panel, Back Filler Patch..... 291
 Panel, Door Jamb Lock Pillar..... 285
 Panel, Exterior Quarter..... 292
Panel, Firewall..... 282-283
 Panel, Header..... 267
 Panel, Inner Wheelhouse..... 295
 Panel, Instrument Cluster..... 112, 113
 Panel, Interior Quarter..... 80
 Panel, Kick..... 81
 Panel, Lower Door..... 79
 Panel, Lower Rear Quarter Patch..... 294-295
 Panel, Outer Rocker..... 284
 Panel, Outer Wheelhouse..... 295
 Panel, Rear Lower Corner..... 315
 Panel, Rear Shelf..... 291
 Panel, Rear Valance..... 315
 Panel, Sail Panel..... 93-94
 Panel, Shift Tunnel..... 304
Panel, Tail Lamp..... 314
Panel, Trunk Finish..... 246
 Panel, Trunk Floor..... 306
 Panel, Trunk Lid..... 308
 Panel, Upper Cowl..... 282
 Panel, Windshield Corner/Cowl Patch..... 283
 Panels, Interior Door..... 66-80
 Panels, Bucket Seat Back..... 58-63
Park Brake Cable..... 349
Park Brake Cable Clip..... 349
Park Brake Cable Clip Bolt..... 349
 Park Lamp Bezel..... 253
Park Lamp Hardware..... 264
 Park Lamp Housing..... 253
 Park Lamp Lens..... 252-253, 264
Park Lamp Lens Gasket..... 253, 264
Park Lamp Pigtail..... 264
 Park Mat..... 191
Parking Brake Actuator Lever..... 363
 Parking Brake Cable..... 146-147, 347
 Parking Brake Cable Clip..... 147
 Parking Brake Cable Guide..... 147
 Parking Brake Cable Hook..... 147
 Parking Brake Connector..... 147
 Parking Brake Equalizer..... 147
 Parking Brake Pedal Assembly..... 147
 Parking Brake Pedal Pad..... 145
 Parking Brake Strut Levers..... 363
 Parking Guide System, Laser..... 190
 Parking Lamp/Turn Signal Bulb..... 249, 301
Parts Tray..... 190, 301

ORDER FORMS & INDEX

Product Index

Patch Panel, Door Skin.....	285
Patch Panel, Trunk Floor.....	307
Patch, Embroidered.....	148
PCV Valve.....	415, 417
Pedal Assembly, Accelerator.....	143
Pedal Assembly, Clutch.....	501
Pedal Assembly, Parking Brake.....	147
Pedal Covers.....	145
Pedal Pad, Accelerator.....	144
Pedal Pad, Brake.....	144-145
Pedal Pad, Clutch.....	145
Pedal Pad, Parking Brake.....	145
Pedal Roller, Accelerator.....	144
Pedal, Dimmer Switch.....	143
Pen.....	148-149
Phantom Key Push Button Start.....	180
Pickup Tube, Oil Pump.....	432
Pigtail, Park Lamp.....	264
Pillar Post Molding.....	89
Pillar, Door Hinge.....	285
Pin, Hat.....	148-149
Pin, Hood.....	270
Pinion Crush Sleeves.....	341
Pinion Snaubber.....	340, 343
Pinion Yoke, Rear End.....	343
Pistol Grip Shift Pattern Insert.....	502
Pistol Grip Shifter.....	502
Pitman Arm.....	328, 330
Pivot Shaft.....	330
Plate, Air Shroud.....	571
Plate, Door Jamb Repair.....	285
Plate, Front Inner Fender Plate.....	279
Plate, License.....	166-167
Plates, Convertible Sun Visor.....	91
Plug, Headlamp Back.....	278
Plenum, Deck Filler Upper.....	291
Pliers, Plugweld.....	322
Plug Wire Sleeve, Heat Insulated.....	471
Plug Wires, Spark.....	435, 442-443
Plug, Oil Drain.....	421
Plug, Oxygen Sensor.....	469
Plug, Trunk.....	301
Plug, Upper Shock.....	301
Plugweld Pliers.....	322
Plymouth Service Policy Booklet.....	215
Points, Ignition.....	440
Polish.....	183
Polish Ball.....	187, 372
Polyurethane Bushing Set.....	334
Power Antenna.....	127
Power Brake Booster.....	352
Power Buffer.....	189
Power Door Lock Conversion.....	289
Power Sprayer.....	186
Power Steering Belt.....	327
Power Steering Bolt Sets.....	325
Power Steering Bracket.....	325
Power Steering Fluid.....	324
Power Steering Gear Box.....	326
Power Steering Hose.....	326
Power Steering Pump.....	324
Power Steering Pump Cap.....	324
Power Steering Pump Decal.....	211
Power Steering Pump Pulley.....	325
Power Steering Pump Rebuild Kit.....	325
Power Steering Return Hose Clamp.....	326
Power Trunk Lock Conversion.....	311
Power Valve, Carburetor.....	467
Power Window Conversion.....	289
Pre-Cleaner, Air Filter.....	422
Pressure/Vacuum Tester, Fuel Pump.....	460
Pressure Plate, Clutch.....	500
Pressure Regulator, Fuel.....	460
Primer Paint.....	196
Projector Circuit Boards.....	108
Projector Style Headlamp.....	248
Proportioning Valve, Brake.....	354
Protector, Battery Cable Terminal.....	507
Pub Tables.....	163
Pulley, Crankshaft.....	405
Pulley, Power Steering Pump.....	325
Pump, Fuel.....	458, 529
Pump, Oil.....	431
Pump, Power Steering.....	324
Pump, Water.....	384

Pump, Windshield Washer.....	321
Push Rod, Clutch Pedal.....	501
Pushrod, Master Cylinder.....	353

Q	
Quarter Extension Gaskets.....	234
Quarter Glass Seal.....	231
Quarter Molding.....	245
Quarter Panel & Door Frame.....	292
Quarter Panel Decal.....	208
Quarter Panel Emblem.....	203
Quarter Panel J Molding.....	245
Quarter Panel Reinforcement.....	295
Quarter Panel Scoops.....	294
Quarter Panel, Exterior.....	296, 299
Quarter Panel, Interior.....	80
Quarter Patch Panel, Lower Rear.....	294-295
Quarter Stick Cover.....	497
Quarter Window Glass.....	237
Quarter Window, Hat.....	245
Quarter Window Vertical Seal.....	231
Quick-Fill Fuel Cap.....	452

R	
Rack & Pinion Steering Conversion.....	327
Radiator.....	376-378
Radiator Cap.....	379
Radiator Fan Blade Spacer.....	382
Radiator Fan Shroud.....	380
Radiator Fan Shroud Hardware.....	380
Radiator Fan Electric.....	381
Radiator Hose Clamp.....	383
Radiator Hose Reducers.....	383
Radiator Overflow Bottle.....	379
Radiator Overflow Bottle Bracket.....	379
Radiator Overflow Bottle Cap.....	379
Radiator Overflow Hose.....	379
Radiator Support.....	267
Radiator Support Brace.....	267
Radio.....	122-124
Radio Antenna.....	127
Radio Bulb.....	249-250
Radio Color Bar.....	126
Radio Face Plate.....	124
Radio Knob.....	124
Radio Module.....	122
Radio Off Delay Module.....	125
Rallye Clock.....	106-107
Rallye Dash Bezel.....	100-102
Rallye Gauge Lens.....	103
Rallye Gauge Set.....	106-107
Rallye Speedometer.....	106-107
Rallye Tachometer.....	105-107
Rallye Wheel.....	365
Rallye Wheel Cap.....	365
Rallye Wheel Trim Ring.....	365
Ram Charger Assembly.....	276-277
Ramcharger Air Box Decal.....	210
Ramcharger Air Door Decal.....	208
Ramps, Vehicle.....	191
Rear Ash Tray.....	340
Rear Axle.....	340
Rear Axle Brake Line T-Block.....	354
Rear Axle Bumper.....	343
Rear Axle Hose Bracket.....	358
Rear Axle Taps.....	342
Rear Bumper.....	260
Rear Bumper Filler Seal.....	262
Rear Bumper Guard.....	261
Rear Cross Rail.....	319
Rear Cross Rail Extensions.....	319
Rear Crossmember Shock Mount.....	319
Rear Disc Brake Conversion Kit.....	345, 348, 350
Rear End Pinion Yoke.....	343
Rear Finish Panel Emblem.....	206
Rear Floor Pan Bracket.....	311
Rear Floor Pan Repair Panel.....	304-305
Rear Frame Triangle Plate.....	319
Rear Lamp Wiring Harness.....	521
Rear Leaf Spring.....	338
Rear Lower Shock Washer.....	337

Rear Lower Window Frame.....	290
Rear Main Seal.....	430
Rear Outer Filler Panel.....	291
Rear Panel Emblem.....	204
Rear Park Brake Set.....	347
Rear Pillar Drip Rail Support.....	290
Rear Quarter Patch Panel.....	278, 294
Rear Quarter Trim Molding.....	245
Rear Roof Bow.....	290
Rear Seat Belt Bracket.....	305
Rear Seat Floor Pan.....	305
Rear Seat Lower Trim Panels.....	59
Rear Seat Speaker Wiring Harness.....	520
Rear Shelf Panel.....	291
Rear Shelf Support.....	291
Rear Shock.....	337
Rear Shock Absorber Grommet.....	337
Rear Side Panel.....	80
Rear Spoiler.....	190, 309
Rear Spoiler Bracket.....	309
Rear Spoiler Gaskets.....	309
Rear Spring Shackle.....	339
Rear Spring Shackle Bushing.....	339
Rear Suspension Bumper.....	333
Rear Sway Bar.....	333
Rear Valance Panel Hardware Set.....	315
Rear View Mirror.....	94
Rear View Mirror Bezel.....	94
Rear View Mirror Bracket.....	94
Rear Window Lock Strip.....	231
Rear Window Molding.....	244
Rear Window Molding, Interior.....	289
Rear Window Trim.....	242
Rear Window Weatherstrip.....	231
Rear Window Adjustment Bolt.....	309
Rebuild Kit, Power Steering Pump.....	325
Rebuild Kit, Transmission.....	498
Rebuild Set, Door Hinge.....	126
Receiver, Radio.....	283
Receiver/Drier, A/C.....	289
Redline Tire, OE Style.....	373-375
Regulator, Door Window.....	289
Regulator, Fuel Pressure.....	460
Regulator, Voltage.....	445
Reinforcement, Quarter Panel.....	295
Reinforcements, Control Arm.....	316
Relay Shifter, Starter.....	449
Relay, Auxiliary Lamp.....	249
Relay, Brake Lamp.....	256
Relay, Fuel Pump.....	460
Relay, Headlamp Motor.....	249
Relay, Road Lamp.....	249
Relay, Starter.....	449
Relay, Water Pump.....	384
Relay/Fuse Assembly.....	250
Reluctor.....	440
Remote Control Battery Disconnect.....	181
Remote Control Ignition System.....	181
Remote Control Starter Switch.....	449
Remote Mirror Bezel.....	487
Remote Start System.....	181
Remote Starter Switch Tool.....	200
Renewal Kit, Trunk.....	313
Repair Panel, Rear Floor Pan.....	304-305
Reservoir Jar, Windshield Washer.....	322
Resonator.....	476, 477
Resonator Strap.....	477
Retainer, Clutch Pedal Bracket.....	501
Retainer, Convertible Boot.....	300
Retainer, Interior Trim.....	291
Retainer, Lower Column Seal.....	135
Retainer, Spark Plug Wire.....	444
Retainer, Steering Coupler.....	135
Reverse Lamp Switch.....	142
Reverse Switch Harness.....	137
Ring-Blow Horn Insert.....	214
Ring & Pinion Set.....	341
Ring Gear Fasteners.....	342
Road Lamp Bezel.....	249
Road Lamp Mounting Bracket.....	249
Road Lamp Relay.....	249
Road Lamp Retaining Clip.....	259
Road Lamp Switch.....	249
Road Lamp Switch Bezel.....	249
Road Lamp Wire Decal.....	214

ORDER FORMS & INDEX 0

Product Index

Road Lamp Wiring Harness.....	249
Road Lamps	249
Road Runner Decals.....	208-209
Road Wheel.....	367
Rocker Molding	243
Rocker Molding Decal	209
Rocker Molding Mounting Hardware.....	243
Rocker Panel	284
Rocker Panel End Cap.....	284
Rocker Stud Removal Tool.....	401
Rocker Switch.....	521
Rod, Clutch Adjusting.....	501
Rod, Shift Linkage	494
Roller Accelerator Pedal.....	144
Roller, Window.....	289
Roof Panel Skin.....	290
Roof Rail Weatherstrip.....	230
Rotabroach Cutter.....	323
Rotor, Brake.....	360-361
Rotor, Distributor.....	440
Rubber Bumper Sets.....	233
Rubber Undercoating Paint.....	196
Rust Prevention	192
Rust Resistor Decal.....	211

S

Safety Loop, Drive Shaft.....	340
Sail Panel.....	93-94
Sail Panel Molding.....	245
Sail Repair Panels.....	290
Sales Brochures.....	169
Satellite Car Of The Year Decal.....	215
SCAT PACK Window Decal.....	208, 218
Scamp, Hood	273-275, 422
Screw Set, Interior.....	95
Screw Set, Six Pack Floot Bowl.....	465
Screw, Arm Rest.....	85
Screw, Door Jamb Seal	230
Screw, Six Pack Vacuum Diaphragm.....	465
Screw, Wheel Opening Molding	240
Screw, Window Crank Handle.....	84
Seal & Lock, Torsion Bar.....	332
Seal End Cap, Door.....	231
Seal Kit, Disc Brake Caliper.....	360
Seal, Accelerator Pedal.....	144
Seal, Airbox to Baseplate.....	421
Seal, Baseplate to Top.....	421
Seal, Convertible Header.....	232
Seal, Convertible Top Bow Retainer.....	232
Seal, Door Jamb U-Seal	230
Seal, Fresh Air Box.....	277
Seal, Fresh Air Trap Door.....	277
Seal, Front Bumper Filler.....	262
Seal, Heater Box To Cowl.....	391
Seal, Hood Scoop To Air Filter.....	421
Seal, Hood To Baseplate.....	421
Seal, Hood To Cowl.....	228
Seal, Hood To Radiator	228
Seal, N96 Air Door.....	234
Seal, N96 Fresh Air Vent.....	271
Seal, Quarter Glass	231
Seal, Quarter Window Vertical.....	231
Seal, Rear Bumper Filler.....	262
Seal, Shaker Baseplate.....	421
Seal, Steering Column.....	134
Seal, Steering Coupler.....	135
Seal, Superflex Nose Cone.....	228
Seals, Convertible Top.....	234
Seals, Velocity Stack.....	371
Seam Buster Chisel Tool.....	222
Seal Back Panels, Bucket.....	58-63
Seal Back Release Bezel	57
Seal Back Release Knob	57
Seal Back Stopper.....	55
Seal Belt Bracket, Rear.....	305
Seal Belt Clips.....	65
Seal Belt Decal.....	215
Seal Belt Guide.....	65
Seal Belt Mounting Cover.....	65
Seal Belt Retaining Clip.....	65
Seal Belt Retractor.....	65
Seal Belt Tag.....	215
Seal Belt Warning Bulb.....	249-250
Seal Belts.....	64-65

Seat Covers, Bench.....	34-57
Seat Covers, Bucket.....	18-33
Seat Emblem.....	57
Seat Floor Pan, Rear.....	305
Seat Foam.....	54
Seat Frame.....	55
Seat Headrest Gasket.....	57
Seat Hinge Cover.....	56
Seat Hinge Washer.....	56
Seat Latch.....	57
Seat Latch Spacers.....	57
Seat Mounting Adapters.....	53
Seat Mounts.....	305
Seat Release Knob	55, 57
Shaker Truck Components.....	55
Seat Upholstery, Bench.....	34-51
Seat Upholstery, Bucket.....	18-33
Seat, Bucket.....	52-53
Security System, GPS.....	180
Shaft, Pivot.....	330
Shaft, Upper Control Arm.....	329
Shaker Baseplate Nut Washer Set.....	421
Shaker Baseplate Seal.....	421
Shaker Decal.....	210
Shaker Drain Hose Set.....	276
Shaker Ground Straps.....	276
Shaker Hood Bubble Fastener.....	276
Shaker Trim Ring.....	276
Sheet Metal Manual.....	178
Shield, Fuel Line.....	358
Shield, Trunk Lock.....	310
Shield, Wheelhouse Vapor Canister.....	318
Shift Handle	502
Shift Handle/Knob.....	493-494, 498
Shift Knob, Transmission.....	487
Shift Knob	502
Shift Lever.....	494
Shift Light.....	121
Shift Linkage Rod	494
Shift Pattern Insert, Pistol Grip.....	502
Shift Tunnel Panel.....	304
Shifter Bezel, Pistol Grip.....	502
Shifter Boot	496, 503
Shifter Boot Bezel.....	503
Shifter Conversion, Pistol Grip.....	494
Shifter Grip, Pistol Grip.....	502
Shifter Handle, Pistol.....	497
Shifter Handle, Slip-Stik.....	494
Shifter Knob Assembly, Automatic.....	494
Shifter Knob Button, Automatic.....	494
Shifter Knob, Custom Pistol Grip.....	502
Shifter Linkage Bushing & Clip.....	502
Shifter Rod Set, Manual Trans.....	503
Shifter Slide, Console.....	140, 142
Shifter, Console.....	494
Shifter, Floor Mount.....	496
Shifter, OE.....	494
Shifter, Performance.....	495-497, 502
Shim, Window Crank.....	84
Shock Absorber	337
Shock Mount, Rear Crossmember.....	449
Shock Plug, Upper.....	307
Shock Washer, Rear Lower	331
Shoes, Drum Brake.....	362
Shop Manual.....	176-179
Shop Manual, Dealer.....	168-169
Shop Manual, Mopar Parts Catalog.....	170
Shop Mirrors.....	183
Shroud, Fan	377, 380
Shutdown Relay.....	448
Side Marker Lamp Assembly.....	254
Side Marker Lamp Bezel.....	255
Side Marker Lamp Bulb.....	249-250
Side Marker Lamp Gasket.....	255
Side Marker Lamp Lens.....	254-255
Side Terminal Adapter, Battery.....	518
Signs, New.....	164
Sill Plate, Door	9
Six Pack Carburetor Installation Kit	467

Six Pack Carburetor Intake Manifold.....	418
Six Pack Vacuum Diaphragm Screw.....	465
Six-Pack Air Cleaner Assembly.....	420
Skid Plate, Oil Pan.....	332
Skin, Quarter Panel.....	293
Skin, Roof Panel.....	290
Smog Pump Belt	469
Snubbers, Pinion.....	340
Socket Ass't Tool.....	471
Socket, Oil Pressure Switch	433
Solenoid, Fresh Air.....	277
Solenoid, Throttle.....	463
Sound Deadener	8, 10-11, 193
Space Saver Tire Decal.....	217
Spacer, Air Cleaner	421
Spacer, Radiator Fan Blade.....	382
Spacer, Seat Latch.....	57
Spacer, Steering Wheel	318
Spare Tire Cover.....	311
Spare Tire Hold Down Bracket.....	311
Spare Tire Inflator Bottle Decal.....	217
Spare Tire Mounting Hardware	311
Spare Tire Wheel Board.....	313
Spark Guard Grease.....	435
Spark Plug Boot, Hemi.....	443
Spark Plug Index Tool	444
Spark Plug Index Washers	444
Spark Plug Wire Heat Shield.....	444-445
Spark Plug Wire Loom Set	444
Spark Plug Wire Retainer.....	444
Spark Plug Wires.....	435, 442-443
Speaker and Rear Defroster Housing.....	125
Speakers.....	125-126
Speedometer Cable.....	104
Speedometer Gauge.....	104-107
Speedometer Gear	104
Speedometer Lens.....	103
Speedometer Sending Unit.....	115, 119
Spindle, Disc Brake.....	331, 348
Splash Shield Center Cap.....	369
Splash Shield Screw Cap	280
Splash Shield, Brake Line.....	359
Splash Shield, Disc Brake.....	361
Splash Shield, Fender	280
Splash Shield, Header.....	449
Splash Shield, Strut.....	280
Splash Shields, Headlamp.....	267
Splash Shields, Rubber	233
Spoiler Decal.....	209
Spoiler, Front.....	206
Spoiler, Rear.....	309
Sport Fry Emblem	206
Spotweld Cutter.....	322-323
Spring, Clutch Pedal Return	501
Spring, Door Hinge.....	286
Spring, Hood.....	269
Spring, License Plate.....	259
Spring, Throttle Return.....	465
Squeeze	189
Sta-Dri Pouch.....	333
Stabilizer Link Bushing Set, Front.....	334
Stamp, Inspection.....	182
Stand, Car Show Display	183
Starter	449
Starter Dust Shield.....	449
Starter Mounting Hardware.....	449
Starter Relay.....	449
Starter Solenoid, Remote.....	449
Steel Body Skeleton.....	282
Steel Wheel.....	364
Steering & Suspension Tools.....	332
Steering Column Bearing, Lower.....	135
Steering Column Bracket.....	135
Steering Column Collar	135
Steering Column Seal.....	134
Steering Column Spring Pin Tool.....	135
Steering Column, Aftermarket Tilt.....	134
Steering Conversion, Rack & Pinion.....	327
Steering Coupler.....	134
Steering Coupler Retainer.....	135
Steering Coupler Seal.....	135
Steering Gear Box.....	326, 328
Steering Links, Sport.....	331
Steering Rod.....	330

Product Index

Steering Wheel	136-139
Steering Wheel Adapter	134, 138
Steering Wheel Emblem	136, 139
Steering Wheel Hardware	138-139
Steering Wheel Lock	138
Steering Wheel Puller Tool	139
Steering Wheel Quick Release	138
Steering Wheel Spacer	138
Steering Wheel	123-124
Stick Lubricant	323
Stone Shield, Front Bumper Lower	266
Stop Lamp Switch	142
Stopper, Seat Back	55
Strap, Battery Cable	507
Strap, Muffler	477
Strap, Resonator	477
Striker, Door Lock	286
Stripes & Graphics	219-227
Strut Levers, Parking Brake	365
Strut Rod Bushing Kit, Polyurethane	334
Strut Rods, Adjustable	331
Strut Splash Shield	280
Stud, Air Cleaner	421, 465
Stud, Wheel	371
Subframe Cap	317
Subframe Connectors	316, 335
Sun Shade, Windshield	180
Sun Visor Bracket Cover	91
Sun Visor Tips	91
Sun Visors	90-92
Super Bee Decal	208, 218
Super Trim Adhesive	89
Supercharging Manual	176
Support, Headlamp & Grill	267
Support, Rear Filling Drip Rail	290
Support, Rear Shelf	291
Support, Trunk	300
Support, Trunk Lock	310
Sure-Grip Differential	342
Surge Differential Warning Decal	217, 218
Surge Protector	448
Suspension Set, Front	330
Suspension System	335-336
Suspension Tie-Down Brackets	319
Sway Bar	333
Sway Bar Link Hardware	332
Sway Bar To Frame Bushing Kit	334
Switch, Battery Cutout	508
Switch, Brake Lamp	142
Switch, Convertible Top	301
Switch, Fresh Air	277
Switch, Headlamp	130
Switch, Ignition	131
Switch, Neutral Safety	494
Switch, Reverse Lamp	242
Switch, Road Lamp	149
Switch, Turn Signal	135
Switches, Door Jam	88
Synthetic Trick Shift Fluid	486

T

T-Shirt	150-155
Tach Adapter	121
Tachometer Gauge	104-107, 141
Tachometer Gauge Harness	105, 519
Tag, Emergency Brake Cable	217
Tag, Engine Break-In	214
Tag, Engine Starting	214
Tag, Key Removal	214
Tag, Master Cylinder	214
Tag, Neutral Safety Switch Harness	214
Tag, Seat Belt	215
Tag, Voltage Regulator	212
Tags, Battery Cable	213
Tags, Fusible Links	213
Tags, Rear Axle	342
Tags, Turn Signal Wire	214
Tail Lamp Assembly	256
Tail Lamp Bezel	257
Tail Lamp Bezel Gasket	235
Tail Lamp Bulb	249-250
Tail Lamp Gasket	258
Tail Lamp Housing	257

Tail Lamp Housing Hardware	257
Tail Lamp Lens	256
Tail Lamp Lens Gasket	257
Tail Lamp Moldings	245
Tail Lamp Panel	314
Tail Lamp Panel End Trim	245
Tail Lamp Stud Protector Set	257
Tail Molding	245-247
Tail Mount Mounting Hardware	247
Tail Panel Decal	247
Tail Panel Emblem	206
Tailpipe Expander Tool	471
Tank, Fuel Cooler	460
Tap, Emblem Attachment	207
Tap, Wire Harness	511
Temperature Control Cable	128
Temperature Gauge	105-107
Temperature Sender, Electric Fan	381
Temperature Sending Unit	419
Terminal Adapter, Battery Side	508
Terminal Pliers, Spark Plug	441
Terminal Protector, Battery Cable	508
Terminal, Accessory	509
Terminal, Battery Cable	508
Terminal Insulation	472-473
Thermometer, Infrared	401
Thermostat	383
Thermostat Decal	211
Thermostat Housing Bolts	383
Throttle Detachable Tool	400
Throttle Cable	457
Throttle Lever Adapter	464
Throttle Linkage	457
Throttle Pedal Assembly	143
Throttle Return Spring	290
Throttle Return Spring Bracket	465
Throttle Solenoid	463
Tic-Toc-Tach	106
Tie Rod Adjusting Sleeve	328
Tie Rod Dust Cap	329
Tie Rod End	328
Tilt Steering Column	134
Tilt Steering Column Bracket	134
Tilt Steering Gasket	409
Timing Light	400-401
Timing Belt Performance	355
Timing Tab, Chrome	409
Tire Cleaner	183, 187, 373
Tire Dressing	186-187, 373
Tire Garage Storage System	191, 372
Tire Pressure Decal	216
Tire Pressure Gauge, Digital	372
Tire Shine	183
Tires	373-375
Toggle Switches	521
Tool, Brake Pad Spreader	127
Tool, Ball Joint Removal	330
Tool, Battery	508-510
Tool, Battery Cable	508
Tool, Battery Load Tester	509
Tool, Brake Pad Spreader	355, 361
Tool, Brake Pressure Gauge	355
Tool, Brake System Bleeder	355, 359
Tool, Brake Tube Bender	355
Tool, Compression Tester	400
Tool, Denol Removal	322
Tool, Door Hangar	286
Tool, Door Hinge Adjuster	286
Tool, Door Panel Remover	71
Tool, Double Flaring	355
Tool, Drive Shaft Adjusting	355
Tool, Electrical	508-511
Tool, Engine	398-399
Tool, Exhaust Pipe Cutter	471
Tool, Headlamp Switch Bezel Nut	130
Tool, Ignition Switch Bezel Nut	131
Tool, Mirror Bezel Nut	287
Tool, Molding Removal	247
Tool, Pro-Crimp	435
Tool, Rocker Dash Clock Cable Nut	107
Tool, Rallye Stud Removal	401
Tool, Sealant Brush Chisel	322
Tool, Spark Plug Index	444
Tool, Spark Plug Wire Removal	443
Tool, Steering Column Spring Pin	135

Tool, Steering Wheel Puller	139
Tool, Tailpipe Expander	471
Tool, Timing Light	400-401
Tool, Trim Remover	89
Tool, Upholstery	87
Tool, Wiper Arm Remover	320
Tool, Wiper Switch Bezel Nut	131
Top Actuator Cylinder, Convertible	301
Top Boot, Convertible	299
Top Plate, Console	140, 142
Top, Convertible	298
Top, Vinyl	296-297
Torque Box	318
Torque Converter	486
Torque Converter Bolt Set	487
Torque Rod, Trunk Lid	308
Torque Shaft Bracket	501
Torque Shaft Bushing	494
Torsion Bar Boot	329
Torsion Bar Cross Member	304
Torsion Bar Lock & Seal	332
Torsion Bar Set	332
Total Performance Paks	318
Touchless Car Cover	190
Towel	188
Transmission Cooler	490
Transmission Cooler Bracket	490
Transmission Cooler Line	491
Transmission Cooler Line Bracket	490
Transmission Dipstick	490
Transmission Dust Shield	490
Transmission Fluid, Max ATF	489
Transmission Mount	492
Transmission Repair Manual	177
Transmission Shift Kit	487
Transmission, Automatic	486-489
Transmission, Under/Overdrive	489
Trap Door, Fresh Air	277
Tray, Battery	504
Tray, Package	96-97
Triangle Plate, Rear Frame	319
Trim Adhesive	89, 207
Trim Molding Set, Windshield	242
Trim Molding, Back Glass Reveal	244
Trim Molding, Convertible Belt	300
Trim Molding, Drip Rail	244
Trim Molding, Front Fender	239
Trim Molding, Front Valance	239
Trim Molding, Grill	238
Trim Molding, Hood Lip	239
Trim Molding, Hood Louver	272
Trim Molding, Interior Rear Window	89
Trim Molding, Pillar Post	89
Trim Molding, Quarter	245
Trim Molding, Sail Panel	245
Trim Molding, Tail Rail	245-247
Trim Molding, Tail Lamp	245
Trim Molding, Trunk Lid	246-247
Trim Molding, Wheel Opening	204-241
Trim Plate, Console Shifter	140, 142
Trim Removal Tool	89
Trim Ring, Rallye Wheel	365
Trim Ring, Shaker	273
Trim, Shanker	141
Trim, Dash Panel Lower	101-102
Trunk Bumper	232
Trunk Divider Board	97
Trunk Divider Insulation	97
Trunk Emblem, Coronet	204
Trunk Extension End Cap	307
Trunk Finish Panel	246
Trunk Floor Extension	307
Trunk Floor Filler Board	313
Trunk Floor Panel	306-307
Trunk Floor Reinforcement	306
Trunk Floor To Valance Bracket	307
Trunk Gutter	310
Trunk Lid Bulb	250
Trunk Lid Emblem	204-205
Trunk Lid Emblem Bezel	204
Trunk Lid Hinge	308
Trunk Lid Latch	308
Trunk Lid Molding	246-247
Trunk Lid Panel	307
Trunk Lid Torque Rod	308

Product Index

Trunk Lock	132
Trunk Lock Shield	310
Trunk Lock Support	310
Trunk Mat	312-313
Trunk Paint	197, 313
Trunk Plug	301
Trunk Renewal Kit	313
Trunk Side Panel Board	313
Trunk Trim Panel Hardware	246
Turbocharging Manual	313
Tube, Heat Riser	469
Tubes And Seals Set	443
Tubular Upper Control Arms	331
Tuff Wheel, OE Style	137
Turbocharging Manual	176
Turn Signal Cancelling Cam	135
Turn Signal Switch	135
Turn Signal Switch Connector	512
Turn Signal Wire Tags	214
Turn Signal, Fender Mounted	251

U

U-Joint Bolts/Straps	343
U-Joint, Driveshaft	343
U-Joint/U-Bolt Service Set	343
Under Dash Courtesy Lamp	133
Under Dash Insulation	128
Under Dash Wiring Harness	519
Underhood Lamp Bulb	250
Underhood Paint	197
Universal Bearing Adapter	361
Universal Coolant Filters	383
Unleaded Fuel Only Decal	216
Upholstery Cleaner	183, 186
Upholstery Installation Kits	55
Upholstery Tool	87
Upholstery, Bench Seat	34-51
Upholstery, Bucket Seat	18-33
Upper Control Arm	331
Upper Control Arm Ball Joint	329
Upper Control Arm Bearing	329
Upper Control Arm Shaft	329
Upper Cowl Panel	282

V

Vacuum	190
Vacuum / Pressure Tester, Fuel Pump	460
Vacuum Actuator Bracket, Fresh Air	277
Vacuum Actuator, Fresh Air	277
Vacuum Advance	441
Vacuum Advance Cover	441
Vacuum Advance Decal	211
Vacuum Canister, AC	389
Vacuum Canister, N96 Fresh Air	277
Vacuum Diaphragm Screw, Six Pack	465
Vacuum Hose Set, N96 Fresh Air	277
Vacuum Pump, Electronic	354
Valance Filler, Front	266
Valance Molding, Front	239
Valance Panel Hardware Set	266
Valance Panel, Front	266
Valley Pan	419
Valve Cover Breather	416-417
Valve Cover Decal	210
Valve Cover Gaskets	416
Valve Cover Grommets	417
Valve Cover Hardware	416
Valve Cover Plug	417
Valve Covers	414-415, 427
Valve Stem Cap	372
Valve Stem Seals	417
Valve, Brake Combination	354
Valve, Heater Bypass	389
Valve, PCV	415, 417
Valve, Proportioning	354
Vapor Separator	457
Vehicle Alarm	181
Vehicle Ramps	191
Vehicle Warranty Information Card	215
Velocity Stack Seals	271
Vent Plug, Door Panel	82
Vent Seal, N96 Fresh Air	271

Vent Tube, Blower Motor	391
Vent Window Frame	242
Vent Window Glass	236
Vent Window Glass Run Seal	228
Vent Window Weatherstrip	228
Vent, Dash	147
Vinyl Dressing	186-187, 373
Vinyl Floor Mats	14-17
Vinyl Top	296-297
Vinyl Top Molding	245
Vinyl Top Molding Clips	245
Visc Grip Flange Pliers	322
Voltage Limiter, Instrument Cluster	104
Voltage Regulator	445
Voltage Regulator Pitfalls	445
Voltage Regulator Tag	212
Voltmeter	105

W

Warm Climate Decal	211
Wash Mitt	188
Wash Stick	189
Washer Pump, Windshield	321
Washer Set, Shaker Baseplate Nut	421
Washer, Armrest Hinge	56
Washer, Seat Hinge	56
Washers, Spark Plug Index	443
Water Pump	384
Water Pump Belt	384
Water Pump Mounting Bolt Set	384
Weatherstripping Adhesive	230
Weatherstrip Plug, Door Window	229
Weatherstrip, Colored Door Seal	230
Weatherstrip, Convertible Pillar Post	232
Weatherstrip, Convertible Top	232
Weatherstrip, Door Frame	230
Weatherstrip, Door Glass	229
Weatherstrip, Rear Window	231
Weatherstrip, Roof Rail	230
Weatherstrip, Trunk	231
Weatherstrip, Window	228
Weatherstrip, Windshield	228
Wedge, Hood	269
Welding Manual	178
Well Liners, Convertible	298
Western Sport Special Decal	209
Wheel Bearing & Seal Kit	361
Wheel Bearing Grease	361
Wheel Center Cap	364-365, 369-370
Wheel Cover Cap Inserts	367
Wheel Chocks	191
Wheel Cleaner	189
Wheel Cribs	191
Wheel Hardware	371
Wheel Lug Nut	371
Wheel Opening Molding	240-241
Wheel Opening Molding Screw	240
Wheel Panel	197
Wheel Spinners	369
Wheel Stud	371
Wheel Trim Ring	365
Wheel, Steering	136-139
Wheel/Tire Hanger, Wall-Mounted	191
Wheelhouse Vapor Canister Shield	318
Wheels	364-370
White Letter Dodge Decal	370
White Letter Tire	373-375
Whiteline Tire	373-375
Windage Tray, Oil Pan	429-430
Windlace	9
Window Crank Handle	84
Window Crank Handle Screw	84
Window Crank Shim	84
Window Frame, Lower Rear	290
Window Fuzzies	229
Window Glass, Quarter	237
Window Glass, Vent	236
Window Latch, Quarter	245
Window Regulator, Door	289
Window Reveal Clip	242
Window Roller	289
Window, Convertible Top Rear	298

Windshield A-Pillar	283
Windshield Corner/Cowl Patch Panel	283
Windshield Glass	236
Windshield Lock Strip	228
Windshield Molding	242
Windshield Molding Clip	242
Windshield Molding Clip Pliers	242
Windshield Mounting Hardware	236
Windshield Sun Shade	180
Windshield Washer Connector	321
Windshield Washer Decal	211
Windshield Washer Hose	321
Windshield Washer Nozzle	321
Windshield Washer Pump	321
Windshield Washer Reservoir Cap	321
Windshield Washer Reservoir Jar	321
Windshield Weatherstrip	228
Wing Nut, Air Cleaner	421, 465
Wiper Arm	320
Wiper Arm Remover Tool	320
Wiper Blades	320
Wiper Motor	320
Wiper Motor Gasket	320
Wiper Motor Nut Set	320
Wiper Motor Wiring Harness	517
Wiper Pivot Gaskets	320
Wiper Switch Bezel	131
Wiper Switch Bezel Nut Tool	131
Wiper Switch Knob	131
Wire Divider Kit	437
Wire Harness Tape	511
Wire Separators	435
Wire Set, Spark Plug	442-443
Wire Tester, Spark Plug	511
Wire, Accessory	449
Wires, Turn Signal Indicator	517
Wiring Conduit	446
Wiring Diagram	170-171
Wiring Diagram Manual	177
Wiring Enclosure	446
Wiring Hardware	446
Wiring Harness	514-524
Wiring Harness & Relay, Fan	382
Wiring Harness Fasteners	512-513
Wiring Harness Wrap	513
Wiring Harness, AC/Heater	520
Wiring Harness, Back-Up Lamp	519-520
Wiring Harness, Console	142
Wiring Harness, Emission Control	516
Wiring Harness, Engine	514-516, 522
Wiring Harness, Front Lamp	517-518
Wiring Harness, H4 Conversion	249
Wiring Harness, Idle Stop Solenoid	518
Wiring Harness, Overhead Console	520
Wiring Harness, Rear Lamp	521
Wiring Harness, Rear Seat Speaker	520
Wiring Harness, Road Lamp	249
Wiring Harness, Tach Gauge	105, 519
Wiring Harness, Under Dash	519
Wiring Harness, Wiper Motor	517
Wiring, Courtesy Lamp	133
Wiring, Electric Fan/Thermostat	381
Wrench, Rear End Bearing Adjuster	342
Wrinkle Paint	196

X

X-Pipe, Exhaust	475
-----------------	-----

Y

Y-Pipe, Exhaust	475
-----------------	-----

Z

Z-Bar, Clutch	500
---------------	-----

ORDER FORMS & INDEX

New Product Showcase



MP41253

1963-66 A-Body Quarter Patch Panels

Replacement quarter patch panels for various 1963-66 models. Each panel features correct gauge sheet metal and original contours.

1963-66 Dart

MP41245	1963-66	LH	wheel arch 37" x 15-1/2".....	159.99	ea
MP41246	1963-66	RH	wheel arch 37" x 15-1/2".....	159.99	ea
MP41247	1963-66	LH	rear lower 34-1/2" x 14-1/2".....	142.99	ea
MP41248	1963-66	RH	rear lower 34-1/2" x 14-1/2".....	142.99	ea

1963-66 Valiant/Barracuda

MP41249	1963-65	LH	wheel arch 40" x 19-1/2".....	199.99	ea
MP41250	1963-65	RH	wheel arch 40" x 19-1/2".....	199.99	ea
MP41251	1963-65	LH	rear lower 30" x 14".....	171.99	ea
MP41252	1963-65	RH	rear lower 30" x 14".....	171.99	ea
MP41253	1966	LH	lower half 66" x 16".....	299.99	ea
MP41254	1966	RH	lower half 66" x 16".....	299.99	ea



MM52305

MM52308



1964-76 Control Arms

Engineered for strength, the QA1 upper and lower control arms offer a great solution to factory control arms without adding weight. These control arms feature tubular construction, black powdercoating, polyurethane bushings and include ball joints. Direct bolt-on for most Mopar applications. Made in USA.

Upper Control Arms

QA1 upper control arms are ready to bolt-on to your Mopar. They include polyurethane inner pivot bushings. These upper control arms increase caster by approximately 3 degrees for better handling.

Note: * For factory disc brake cars and cars with OE-type disc brake conversions with factory parts.

A-Body

MM52303	1964-72	with small ball joints.....	299.99	set
MM52301*	1964-72	with large ball joints.....	299.99	set
MM52301*	1973-76	299.99	set

B-Body

MM52305	1962-72	299.99	set
---------	---------	-------	--------	-----

E-Body

MM52305	1970-74	299.99	set
---------	---------	-------	--------	-----

Lower Control Arms

QA1 lower control arms are a direct bolt-on for factory or QA1 K-members and are twice as strong as factory arms. The set includes bushings, pivots and nuts for ease of installation. Include sway bar tabs. Do not have ball joints. Sold as a set.

Note: * Designed to work with the 1964-66 A-Body without a sway bar and the 1967-73 A-Body with the 1973-76 sway bar or "flat bar."

** Only recommended for 1962-70 B-Body applications without a sway bar or with QA1 K-Member MM52315 and an E-Body sway bar.

*** Designed to work with the E-Body sway bar and the 1971-72 B-Body sway bar.

A-Body

MM52307**	1964-76	384.99	set
-----------	---------	-------	--------	-----

B-Body

MM52308**	1962-72	384.99	set
-----------	---------	-------	--------	-----

E-Body

MM52308***	1970-74	384.99	set
------------	---------	-------	--------	-----



1961-65 License Lamp Lens

Reproduction license lamp lens for all 1961-65 Dodge and Plymouth models.

Manufactured to factory specifications each lens features the correct markings and are coated with a special UV

protector to prevent fading and cracking due to exposure from the elements. Mounting gasket is included.

MD4713	1961	34.99	ea
MD4714	1962-65	34.99	ea



MD4714



ME7177

3590127

ME7178

3590126

1970-74 E-Body Dash Emblems

Reproduction dash pad emblems for 1970-74 E-Body models. 1970 Challenger and Barracuda emblems are made from injection molded ABS and feature chrome lettering. 1971-74 Challenger and Barracuda emblems feature an embossed metal insert attached to a plastic bezel, as original. 1971-74 emblems are also available as a metal insert only without the plastic bezel for use when your original bezel is intact. All emblems include mounting hardware where applicable.

1970-74 Challenger

ME8167	1970-74	Challenger script emblem.....	34.99	ea
ME7177	1971-74	Challenger emblem insert only - OER®.....	19.99	ea
3590127	1971-74	Challenger emblem insert w/bezel - OER®.....	34.99	ea

1970-74 Barracuda

ME8166	1970	Barracuda script emblem.....	34.99	ea
ME7178	1971-74	Barracuda emblem insert only - OER®.....	19.99	ea
3590126	1971-74	Barracuda emblem insert w/bezel - OER®.....	34.99	ea



TA9158145



TA9158145 - detail view

Superlite Aluminum Race Wheels

The Superlite race wheel puts you back in the heart of the Trans Am Era, Pony car racing! These wheels will set off your Mopar when you are out on cruise night or on the autocross track showing off your driving skills. These are a gravity cast, high quality aluminum which is then heat & age treated to T6 specifications. The Australian engineer & designed Superlite wheel is more than a pound lighter than the original Minilite and has been re-engineered to strengthen the core of the spokes and the wheel center. The wheel is load rated to 1780lbs (850kg). With the pressed steel inserts, you will not damage your track day wheels during installation. After machining, the wheels are given a silver and clear powder coat. The signature finish on the lip is machined by a diamond pit then brought to a high polish. Includes cap, Lug nuts sold separately. TA9158145 15" x 8" 5 x 4-1/2" 4-1/2" backspacing..... 214.99 ea



CALL TOLL-FREE OR
ORDER ONLINE TODAY

1-800-854-1280 | classicindustries.com



JK37.352

1970-76 A-Body Speedometer

Reproduction 120 MPH speedometers for 1970 Plymouth A-Body models including Valiant, Duster and Scamp, and 1972-76 Dodge & Plymouth A-Body vehicles. Manufactured with the correct font and authentic colored needle. Includes the turn signal and high beam tubes and lenses. Officially licensed Mopar Authentic Restoration Product.

Note: This 120 MPH speedometer is correct for 1972-74 but will fit and function in 1975-76 models. 1975-76 models used a 100 MPH speedometer.

2984960 1970 Plymouth..... 299.99 ea
3837352* 1972-76 Dodge & Plymouth..... 249.99 ea

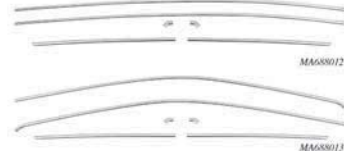

MA688012

MA688013

1967-76 A-Body Drip Rail Moldings

Reproduction drip rail molding sets for various 1967-76 A-Body models. Manufactured to factory specifications featuring original style contours and correct stainless steel finish.

MA688012 1967-69 Barracuda - fastback..... 199.99 set
MA688013 1967-69 Barracuda - coupe..... 199.99 set
MA688018 1967-76 Dart 2 door hardtop..... 199.99 set
MA688014 1970-76 Duster..... 199.99 set
MA688014 1971-72 Demon..... 199.99 set
MA688018 1972-76 Scamp..... 199.99 set
MA688014 1973-76 Dart Sport..... 199.99 set



FREE
Look out car thieves! Buy
a \$100.00 value!



OER AUTHORIZED



Diamond Blue™

★ **Indoor Use**
★ **Single Layer Material**



Diamond Blue

1960-76 Diamond Blue Car Covers

Protect your Mopar Muscle Car from dust and dirt with OER® Authorized custom fit Diamond Blue™ car covers. Designed for use indoors, the Diamond Blue™ is manufactured using an economical single layer material that provides good protection from dust and dirt penetration. Includes non-scratch grommets installed on each side of the cover to allow the use of a tie-strap and lock.

A-Body

MT3300A 1960-62 Lancer & Valiant..... Reg. ~~99.00~~ 79.99 ea
MT4101A 1963-66 Valiant..... Reg. ~~99.00~~ 79.99 ea
MT3501A 1967-76 all (exc. Barracuda Fastback)..... Reg. ~~99.00~~ 79.99 ea
MT4104A 1964-66 Barracuda Fastback..... Reg. ~~99.00~~ 79.99 ea
MT4105A 1967-69 Barracuda Fastback..... Reg. ~~99.00~~ 79.99 ea

B-Body

MT4106A 1962-70 all (except Charger)..... Reg. ~~99.00~~ 79.99 ea
MT4110A 1966-67 Charger..... Reg. ~~99.00~~ 79.99 ea
MT4106A 1968-70 Charger..... Reg. ~~99.00~~ 79.99 ea
MT4107A 1971-72 all 2 door..... Reg. ~~99.00~~ 79.99 ea
MT8506A 1971-74 all 4 door..... Reg. ~~99.00~~ 79.99 ea
MT4111A 1973-74 all 2 door..... Reg. ~~99.00~~ 79.99 ea

E-Body

MT4112A 1970-72 Barracuda, Cuda..... Reg. ~~99.00~~ 79.99 ea
MT4113A 1973-74 Barracuda, Cuda..... Reg. ~~99.00~~ 79.99 ea
MT4114A 1970-72 Challenger..... Reg. ~~99.00~~ 79.99 ea
MT4115A 1973-74 Challenger..... Reg. ~~99.00~~ 79.99 ea

